

Precision Voltage Reference

FEATURES

- Very High Accuracy: +10 V Output, ± 0.5 mV
- Extremely Low Drift: 1.11 ppm/ $^{\circ}$ C (-55 $^{\circ}$ C to +125 $^{\circ}$ C)
- Low Warm-up Drift: 1 ppm Typical
- Excellent Stability: 6 ppm/1000 Hrs. Typical
- Excellent Line Regulation: 3 ppm/V Typical
- Hermetic 20-terminal Ceramic LCC Package
- Military Processing Option



APPLICATIONS

- Precision A/D and D/A Converters
- Transducer Excitation
- Accurate Comparator Threshold Reference
- High Resolution Servo Systems
- Digital Voltmeters
- High Precision Test and Measurement Instruments

DESCRIPTION

VRE210 Series Precision Voltage References provide ultrastable +10 V outputs with ± 0.5 mV initial accuracy and temperature coefficient as low as 1.11 ppm/ $^{\circ}$ C over the full military temperature range. This improvement in accuracy is made possible by a unique, proprietary multipoint laser compensation technique. Significant improvements have been made in other performance parameters as well, including initial accuracy, warm-up drift, line regulation, and long term stability, making the VRE210 series the most accurate and stable 10 V surface mount reference available.

VRE210 devices are available in two operating temperature ranges, -25 $^{\circ}$ C to +85 $^{\circ}$ C and -55 $^{\circ}$ C to +125 $^{\circ}$ C, and two electrical performance grades. All devices are packaged in 20-terminal ceramic LCC packages for maximum long-term stability. "M" versions are screened for high reliability and quality.

SELECTION GUIDE

Model	Output (V)	Temperature Operating Range	Volt Deviation (Max)
VRE210CA	+10	-25 $^{\circ}$ C to +85 $^{\circ}$ C	± 0.6 mV
VRE210M	+10	-55 $^{\circ}$ C to +125 $^{\circ}$ C	± 1.2 mV
VRE210MA	+10	-55 $^{\circ}$ C to +125 $^{\circ}$ C	± 1.0 mV

TYPICAL CONNECTION

Figure 1: Typical Connection

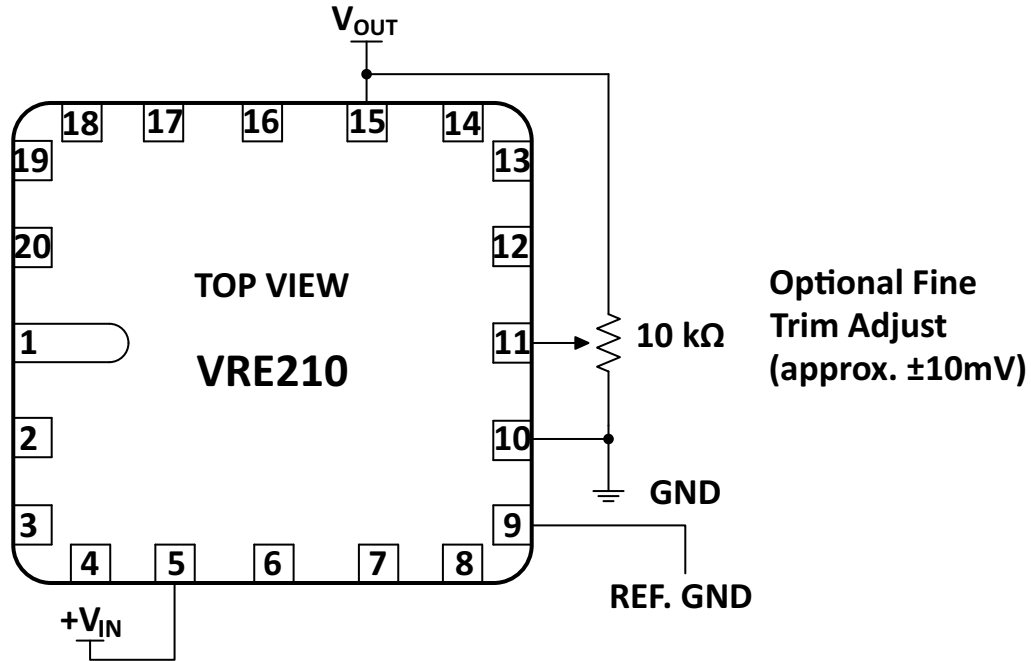

PIN DESCRIPTIONS

Pin Number	Name	Description
5	V_{IN}	The supply voltage connection.
9	REF_GND	Provided for accurate ground sensing. Internally connected to GND.
10	GND	Ground.
11	TRIM	Optional fine adjustment. Connect to a voltage divider between OUT and GND.
15	OUT	10 V output.

SPECIFICATIONS

$V_{IN} = +15\text{ V}$, $T = 25^\circ\text{C}$, $R_L = 10\text{ k}\Omega$ unless otherwise noted.

ABSOLUTE MAXIMUM RATINGS

Parameter	VRE210CA			VRE210M			VRE210MA			Units
	Min	Typ	Max	Min	Typ	Max	Min	Typ	Max	
Power Supply	+13.5		+22	*		*	*		*	V
Operating Temperature	-25		-85	-55		+125	-55		+125	$^\circ\text{C}$
Storage Temperature	-65		+150	*		*	*		*	$^\circ\text{C}$
Short Circuit Protection	Continuous			*			*			

ELECTRICAL SPECIFICATIONS

Parameter	VRE210CA			VRE210M			VRE210MA			Units
	Min	Typ	Max	Min	Typ	Max	Min	Typ	Max	
Output Voltage		+10			*			*		V
Initial Error			± 500			± 1000			± 800	μV
Warmup Drift		1			2			1		ppm
$T_{MIN} - T_{MAX}^1$			600			1200			1000	μV
Long-Term Stability		6			*			*		ppm/ 1000hrs
Noise (0.1 - 10Hz)		6			*			*		μVpp
Output Current	± 10			*			*			mA
Line Regulation		3	10		*	*		*	*	ppm/V
Load Regulation		3			*			*		ppm/ mA
Output Adjustment		20			*			*		mV
Temperature Coefficient		4			*			*		mV/ $^\circ\text{C}$ / mV
Power Supply Current, +PS ²		5	7		*	*		*	*	mA

1. Using the Box Method, the specified value is the maximum deviation from the output voltage at 25°C over the specified operating temperature range.
2. The specified values are unloaded.

Note: * Same as CA Model.

TYPICAL PERFORMANCE GRAPHS

Figure 2: V_{OUT} vs. Temperature (VRE210CA)

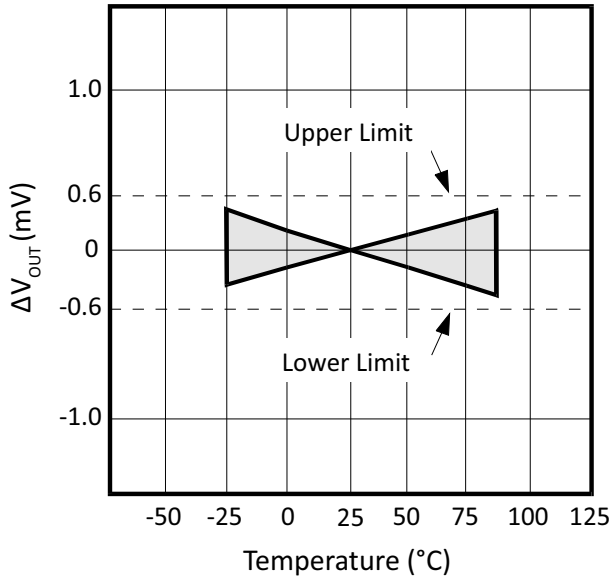

Figure 3: V_{OUT} vs. Temperature (VRE210M)

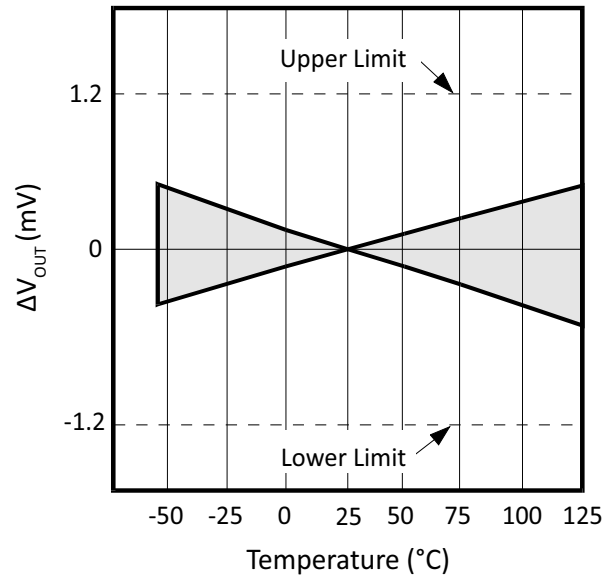

Figure 4: V_{OUT} vs. Temperature (VRE210MA)

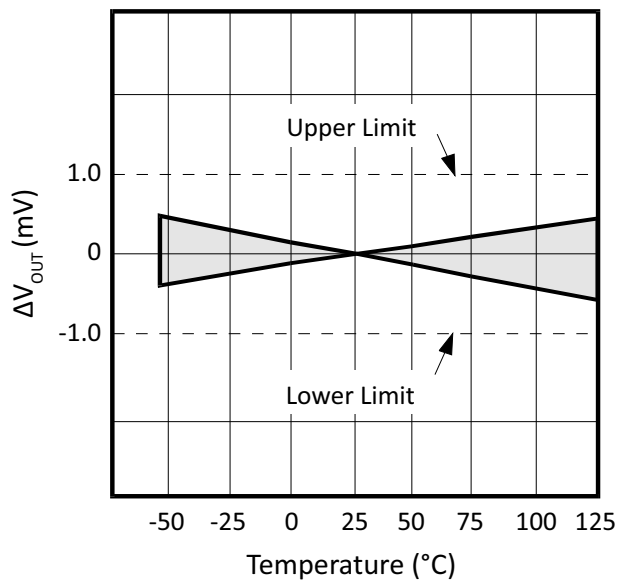

Figure 5: Power Supply Current vs. Temperature

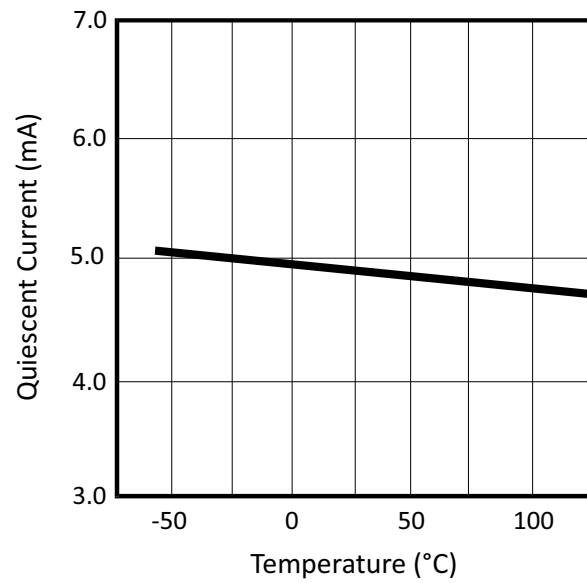

Figure 6: Junction Temp. Rise vs. Output Current

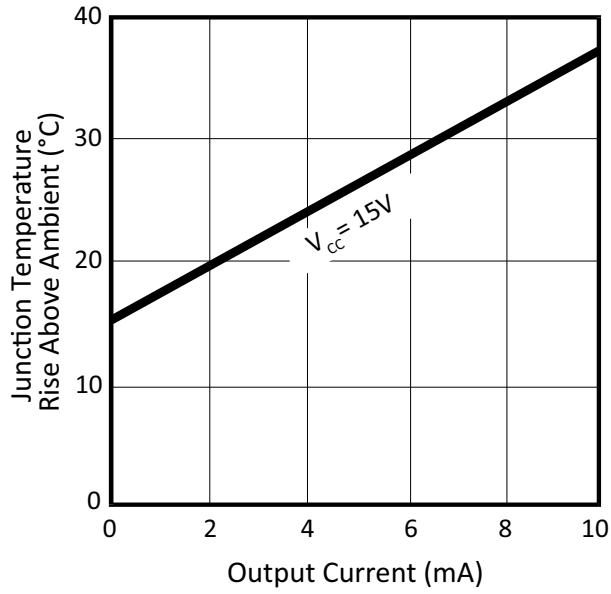
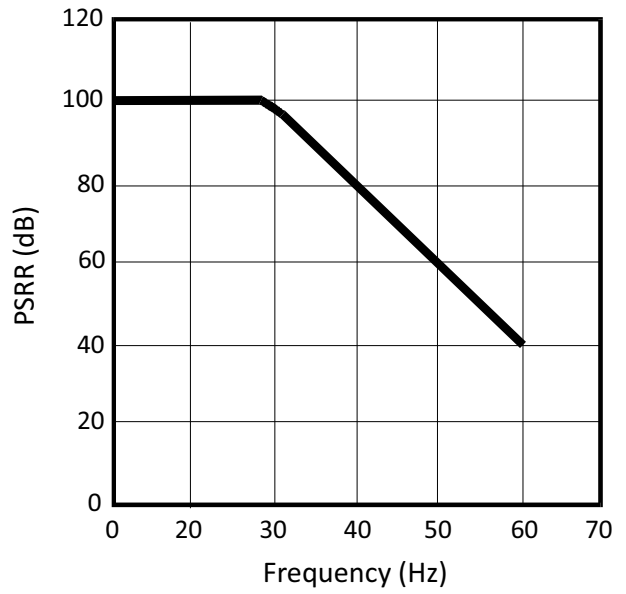
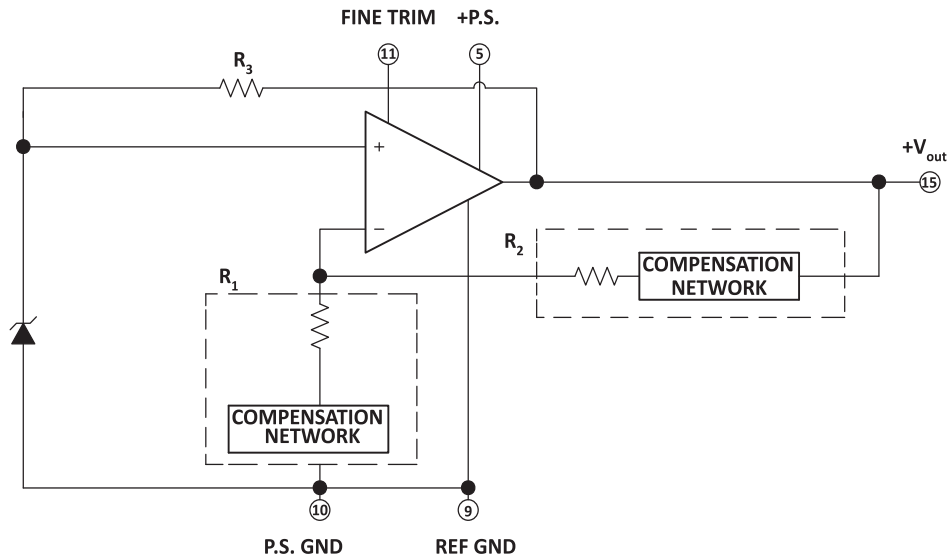

Figure 7: PSRR vs. Frequency



BLOCK DIAGRAM

Figure 8: Block Diagram



THEORY OF OPERATION

The following discussion refers to the block diagram in Figure 8. In operation, approximately 6.3 volts is applied to the noninverting input of the op amp. The voltage is amplified by the op amp to produce a 10 V output. The gain is determined by the networks R1 and R2: $G=1 + R2/R1$. The 6.3V zener diode is used because it is the most stable diode over time and temperature.

The zener operating current is derived from the regulated output voltage through R3. This feedback arrangement provides a closely regulated zener current. This current determines the slope of the references' voltage vs. temperature function. By trimming the zener current a lower drift over temperature can be achieved. But since the voltage vs. temperature function is nonlinear this compensation technique is not well suited for wide temperature ranges.

A nonlinear compensation network of thermistors and resistors that is used in the VRE series voltage references. This proprietary network eliminates most of the nonlinearity in the voltage vs. temperature function. By then adjusting the slope, Apex Microtechnology produces a very stable voltage over wide temperature ranges. This network is less than 2% of the overall network resistance so it has a negligible effect on long term stability. By using highly stable resistors in our network, we produce a voltage reference that also has very good long term stability.

APPLICATION INFORMATION

The proper connection of the VRE210 series voltage references with the optional trim resistor is shown in figure 1. Pay careful attention to the circuit layout to avoid noise pickup and voltage drops in the lines.

The VRE210 series voltage references have the ground terminal brought out on two pins (pin 9 and pin 10) which are connected together internally. This allows the user to achieve greater accuracy when using a socket. Voltage references have a voltage drop across their power supply ground pin due to quiescent current flowing through the contact resistance. If the contact resistance was constant with time and temperature, this voltage drop could be trimmed out. When the reference is plugged into a socket, this source of error can be as high as 20 ppm. By connecting pin 10 to the power supply ground and pin 9 to a high impedance ground point in the measurement circuit, the error due to the contact resistance can be eliminated. If the unit is soldered into place, the contact resistance is sufficiently small that it does not effect performance.

PIN CONFIGURATION

Figure 9: Pin Configuration

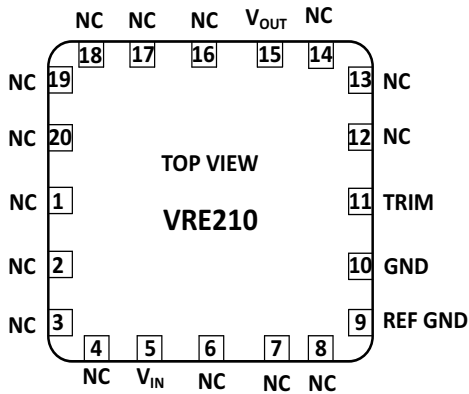

PACKAGE OPTIONS

Part Number	Apex Package Style	Description
VRE210CA	HD	20-terminal Ceramic LCC
VRE210M	HD	20-terminal Ceramic LCC
VRE210MA	HD	20-terminal Ceramic LCC

PACKAGE STYLE HD

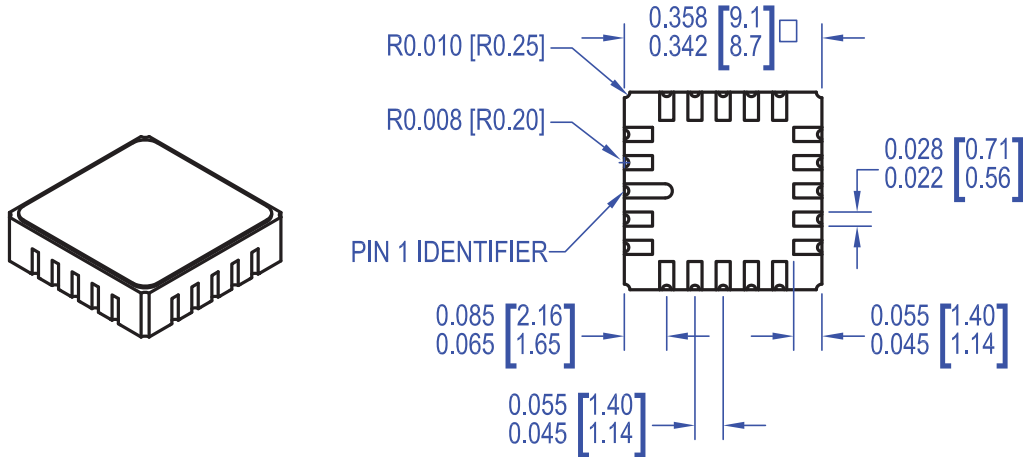

NOTES:

1. Dimensions are inches & [millimeters].
2. Bracketed alternate units are for reference only.
3. Contacts: Gold over Nickel plate.
4. Material: Alumina Ceramic substrate and cover.
5. Cover: Electroless Nickel plated.
6. Package weight: 0.024 oz. [0.680 g].

NEED TECHNICAL HELP? CONTACT APEX SUPPORT!

For all Apex Microtechnology product questions and inquiries, call toll free 800-546-2739 in North America. For inquiries via email, please contact apex.support@apexanalog.com. International customers can also request support by contacting their local Apex Microtechnology Sales Representative. To find the one nearest to you, go to www.apexanalog.com

IMPORTANT NOTICE

Apex Microtechnology, Inc. has made every effort to insure the accuracy of the content contained in this document. However, the information is subject to change without notice and is provided "AS IS" without warranty of any kind (expressed or implied). Apex Microtechnology reserves the right to make changes without further notice to any specifications or products mentioned herein to improve reliability. This document is the property of Apex Microtechnology and by furnishing this information, Apex Microtechnology grants no license, expressed or implied under any patents, mask work rights, copyrights, trademarks, trade secrets or other intellectual property rights. Apex Microtechnology owns the copyrights associated with the information contained herein and gives consent for copies to be made of the information only for use within your organization with respect to Apex Microtechnology integrated circuits or other products of Apex Microtechnology. This consent does not extend to other copying such as copying for general distribution, advertising or promotional purposes, or for creating any work for resale.

APEX MICROTECHNOLOGY PRODUCTS ARE NOT DESIGNED, AUTHORIZED OR WARRANTED TO BE SUITABLE FOR USE IN PRODUCTS USED FOR LIFE SUPPORT, AUTOMOTIVE SAFETY, SECURITY DEVICES, OR OTHER CRITICAL APPLICATIONS. PRODUCTS IN SUCH APPLICATIONS ARE UNDERSTOOD TO BE FULLY AT THE CUSTOMER OR THE CUSTOMER'S RISK.

Apex Microtechnology, Apex and Apex Precision Power are trademarks of Apex Microtechnology, Inc. All other corporate names noted herein may be trademarks of their respective holders.