



SPECIFICATIONS

Model	Max Torque	Reverse Torque	Damping Direction	Max Angle
FYN-M1-L602	0.60Nm (6.0kgfcm)	0.4Nm or lower (4kgfcm or lower)	Counter-clockwise	180°

Max Cycle Rate	Operating Temperature	Weight	Body and Cap Material	Rotating Shaft Material	Oil Type	Cap Color
6 cycle/min	-5 ~ 50°C	17±2g	Polybutylene terephthalate (PBT)	Zinc die-cast (ZDC)	Silicone Oil	Gray

DAMPING CHARACTERISTICS

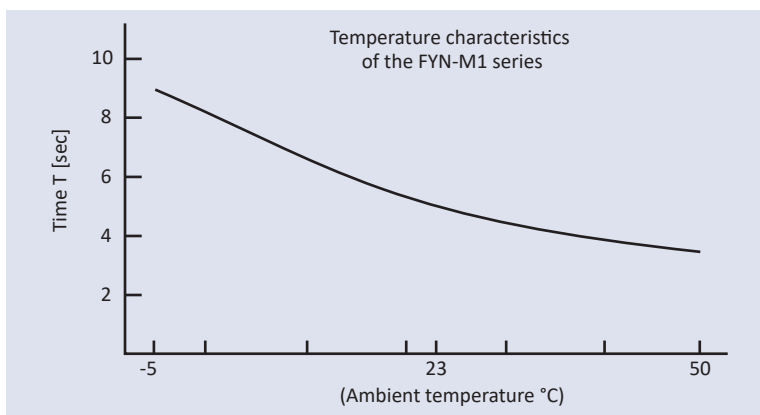

■ The time it takes for a lid with a damper to close varies according to the ambient temperature. As the temperature increases, it takes less time, and as the temperature decreases, it will take longer for the lid to close. This is because the viscosity of the oil inside the damper changes according to the temperature. When the temperature returns to normal, the required time will return to normal as well. The temperature characteristics are shown in the graph to the left.

■ To the right is a graph showing the relationship between the load torque and the time when a lid is closed from a 160° angle, as shown in the diagram.

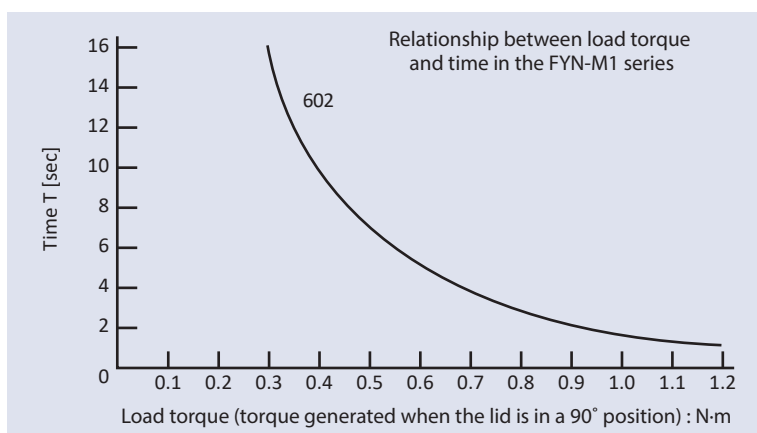
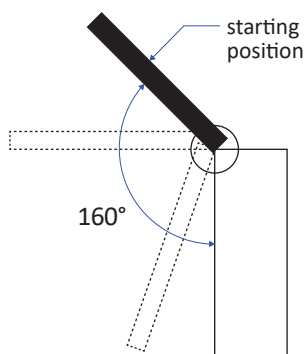

HOW TO USE THE DAMPER

■ The FYN-M1 Series is designed to generate a large torque up to 90° in a closing lid, as shown in Diagram A, and the lid is able to close completely. However, when the lid is closed from a vertical position, as shown in Diagram B, the lid cannot be slowed down, as the torque becomes small just before the lid is completely closed.

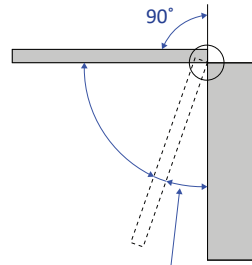

Diagram A

The damper torque becomes smaller, allowing the lid to close completely.

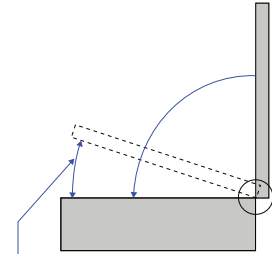
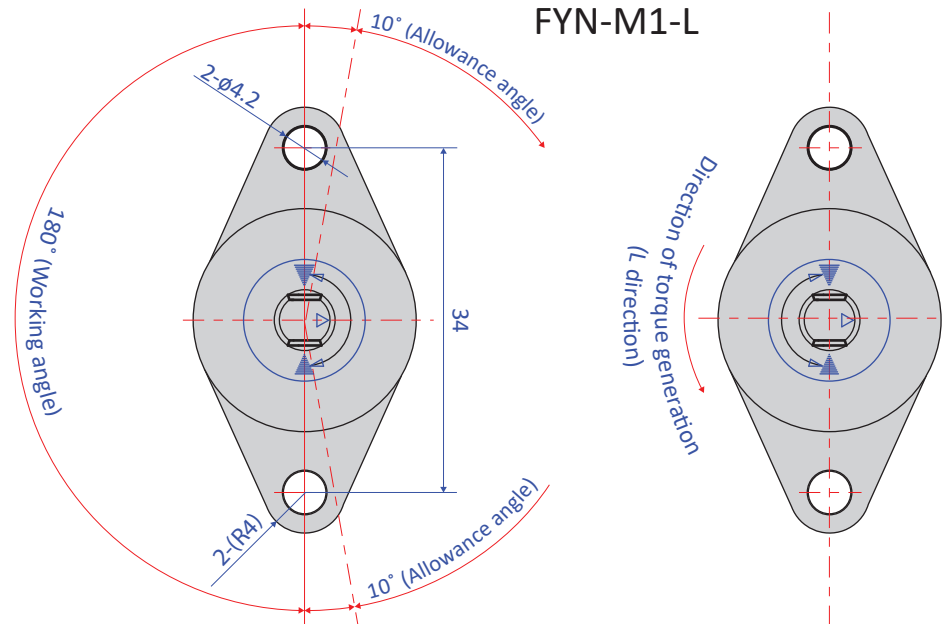
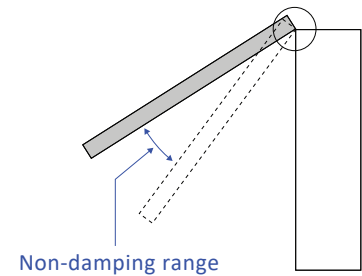
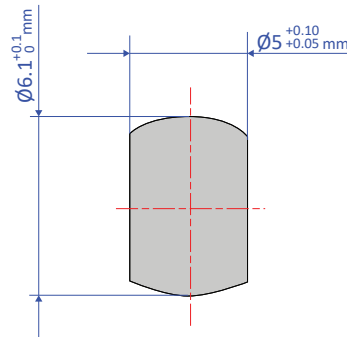

Diagram B

The damper torque becomes smaller, preventing the lid from slowing down.

■ When connecting the rotating shaft to other parts, please ensure a tight fit between them. Without a tight fit, the lid will not slow down properly when closing. Recommended dimensions for a rotating shaft opening are shown to the right.



■ The standard for a damper's working angle is 180° with respect to the main body's attachment flange. Rotating the damper beyond this angle will cause damage to the damper. Please make sure that an external stopper is in place.

■ The direction in which torque is generated varies according to the model. Please select the appropriate model for your purpose.