

Eight-Channel Squib Drivers

Check for Samples: [TPIC71008-Q1](#)

FEATURES

- Eight-channel squib drivers for airbag application
- Loop diagnostics monitor and reporting
- Two logic inputs providing independent safing logic for enabling/disabling deployment
- Eight independent thermally protected High Side drivers that can source deployment or diagnostic current level to each squib load
- Eight independent avalanche voltage and thermally protected Low Side drivers that can sink deployment or diagnostic current level from each squib load
- Each output capable of 1.2A/1.75A firing current for typical 2ms/0.5ms
- SPI Slave Interface for serial bus communication with parity check
- Firing VZx voltage range 10V to 35V, transients up to 40V
- Programmable firing time up to 8.2 ms
- Common Load current settings for all deployment loops, using registers
- Individual firing current timer limit set for each deployment loop, using registers
- Firing current timer to monitor firing current over deployment time for each deployment loop
- Independent switch control for both high and low side switches
- Diagnostic mode for fault checking
- Internal fault monitoring for safe operation
- A multiplex-able output buffer for analog voltage measurements
- Use of external clamping devices on squib pins is not required to protect the deployment ASIC against substrate injection effects during deployment due to dynamic shorts to ground
- An external pin connection to the microprocessor ADC supply for ratio-metric squib resistance measurement.
- 40V pin capability on all pins (except GNDx, AGND, DGND, VCC5, VDDIO, AMX_OUT)
- Operating ambient temperature range: -40°C to 105°C

- Thermally enhanced 48-pin TSSOP DCA PowerPad package

APPLICATIONS

- Squib Drivers for Airbag Application

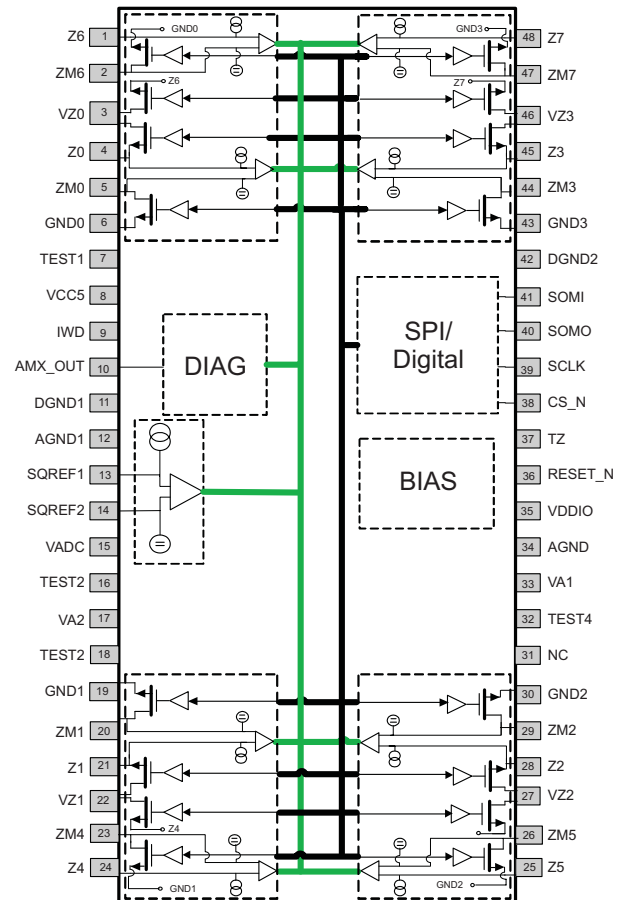
PRODUCT PREVIEW

Please be aware that an important notice concerning availability, standard warranty, and use in critical applications of Texas Instruments semiconductor products and disclaimers thereto appears at the end of this data sheet.

DESCRIPTION

The TPIC71008 is an eight channel squib driver for airbags deployment in automotive applications. Each channel consists of a high side and low side switch with independent control logic for protection against inadvertent deployment. Both the high and the low side switches have internal current limit and over-temperature protection.

The IC registers are used for eight channel configuration, control and status monitoring. To prevent inadvertent deployment, the high and the low side switches are turned on only if the proper configuration sequence is used, two independent arming/safing inputs are active and multiple inputs to the deploy controller logic are at the correct level. The registers are programmed using a serial communications interface.

To prevent excessive power dissipation the maximum active ON time for each channel is limited by programmable Firing Time Out Timer. In addition, a current limit register is used to program the maximum current through the switches during a deployment. The current limitation on the low side switch is larger than the corresponding current limitation on the high side switch. During deployment, the low side switch is fully enhanced and operates with RDS_ON mode, while the high side switch is in current regulation mode.

IC diagnostic functions monitor deployment pin voltages to facilitate High Side switch test, Low Side switch test, squib resistance measurements, squib leakage measurement to battery or ground or leakage between any squib channels. The squib leakage measurement does not require the squib load to be present and covers both Zx and ZMx pins. Diagnostic information is communicated through the AMX_OUT pin (for analog signals) and SPI mapped status registers (for status signals latched in digital core).

The high-side and low-side squib drivers have a diagnostic level current limit and a deployment level current limit. The default current limit for high-side and low-side squib drivers is the diagnostic level current limit. The high-side switch deployment current limit for all high-side drivers can be set to either 1.2 A min or 1.75 A min (see [Table 1](#)) through SPI mapped registers and device EEPROM settings (see [Table 2](#)). The low-side switch deployment current limit is not programmable and is fixed to a level greater than the high-side driver current limit. The ON time duration for each individual squib driver can be programmed through SPI mapped registers.

The deployment sequence requires a specific set of software commands combined with external hardware arming/safing logic inputs (TZ=H, IWD=L) to provide deployment capability. The turn-on sequence of the high-side and low-side drivers is software controlled via SPI commands. The turn-off procedure is automatically controlled by the deployment ASIC for the high side drivers, while the low side drivers turn-off procedure can be controlled by the deployment ASIC or by software via SPI commands. After the programmed ON time deployment has been achieved, the high-side driver is deactivated first. It is followed by the low-side driver deactivation after approximately 100usec (in case of hardware control turn-off sequence device configuration), or after SPI command for low side driver turn-off has been received from an external microcontroller (in case of software control turn-off sequence device configuration).

The RESET_N is an active low input reset signal. This input will be released high by the power supply unit and/or the external microcontroller once the external voltage supplies are within the specified limits. The external microcontroller is required to configure and control device through the serial communication interface. Reliable software is critical for the system operation.

Table 1. Potential Deployment Settings for Typical Firing Current

FIRING VOLTAGE	MAXIMUM AVERAGE FIRING VOLTAGE BETWEEN VZx AND Zx PINS TO ACHIEVE DEPLOYMENT	TYPICAL FIRING CURRENT	DWELL (FIRING) TIME
35 V	32.56 V	1.2 A	2 ms ⁽¹⁾
35 V	35.0 V	1.75 A	0.5 ms ⁽¹⁾

(1) For programming desired dwell (firing) time

Extended deployment duration activates the over-temperature protection circuit and terminates deployment. If short-to-ground condition occurs during deployment, 35-V firing voltage is completely dropped across the HS_FET, thereby thermal shut down protection kicks in to protect the device.

Table 2. Potential Deployment Settings for Maximum Firing Current

FIRING VOLTAGE	MAXIMUM AVERAGE FIRING VOLTAGE BETWEEN VZX AND ZX PINS TO ACHIEVE DEPLOYMENT	MAX FIRING CURRENT ⁽¹⁾	DWELL (FIRING) TIME
35 V	30 V	2.6 A (for 1.75 A current setting)	0.7 ms ⁽²⁾
35 V	31 V	2.0 A (for 1.2 A current setting)	2.0 ms ⁽²⁾

- (1) The max firing current levels are set through device EEPROM setting
- (2) For programming desired dwell (firing) time

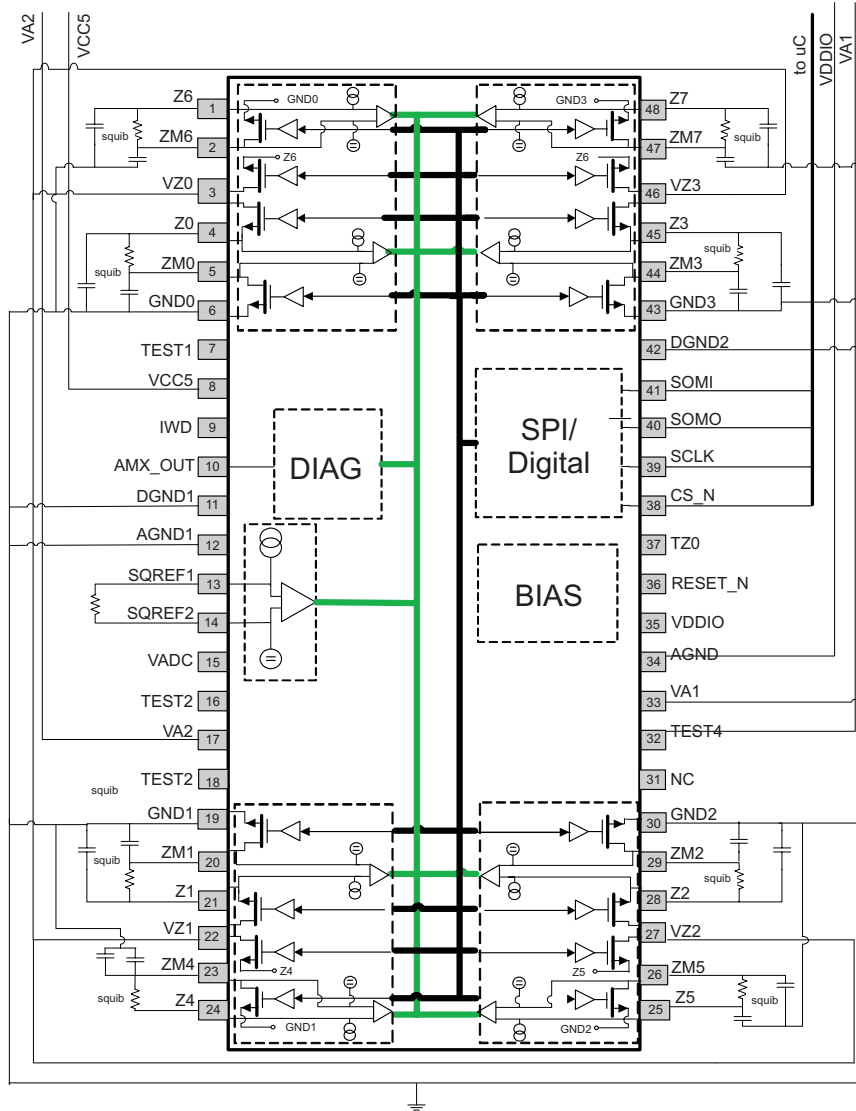

Figure 1. Functional Block Diagram

For the full version of this document, please contact msamktg@list.ti.com.

PRODUCT PREVIEW

ORDERING INFORMATION

T _A	PACKAGE ⁽¹⁾		ORDERABLE PART NUMBER	TOP-SIDE MARKING
-40°C to 105°C	HTSSOP – DCA	Tape and reel	TPIC71008TDCAQ1	TPIC71008
			TPIC71008TDCARQ1	

(1) "Pb-Free" is defined to be compliant with the current RoHS requirements for all 6 substances, including the requirement that lead not exceed 0.1% by weight in homogeneous materials unless exempt. Where designed to be soldered at high temperatures, TI "Pb-Free" and "RoHS Compliant" products are suitable for use in specified lead-free processes.

PRODUCT PREVIEW

PACKAGING INFORMATION

Orderable Device	Status (1)	Package Type	Package Drawing	Pins	Package Qty	Eco Plan (2)	Lead/Ball Finish (6)	MSL Peak Temp (3)	Op Temp (°C)	Device Marking (4/5)	Samples
TPIC71008TDCARQ1	ACTIVE	HTSSOP	DCA	48	2000	Green (RoHS & no Sb/Br)	NIPDAU	Level-3-260C-168 HR	-40 to 105	TPIC71008T	

(1) The marketing status values are defined as follows:

ACTIVE: Product device recommended for new designs.

LIFEBUY: TI has announced that the device will be discontinued, and a lifetime-buy period is in effect.

NRND: Not recommended for new designs. Device is in production to support existing customers, but TI does not recommend using this part in a new design.

PREVIEW: Device has been announced but is not in production. Samples may or may not be available.

OBSELETE: TI has discontinued the production of the device.

(2) **RoHS:** TI defines "RoHS" to mean semiconductor products that are compliant with the current EU RoHS requirements for all 10 RoHS substances, including the requirement that RoHS substance do not exceed 0.1% by weight in homogeneous materials. Where designed to be soldered at high temperatures, "RoHS" products are suitable for use in specified lead-free processes. TI may reference these types of products as "Pb-Free".

RoHS Exempt: TI defines "RoHS Exempt" to mean products that contain lead but are compliant with EU RoHS pursuant to a specific EU RoHS exemption.

Green: TI defines "Green" to mean the content of Chlorine (Cl) and Bromine (Br) based flame retardants meet JS709B low halogen requirements of <=1000ppm threshold. Antimony trioxide based flame retardants must also meet the <=1000ppm threshold requirement.

(3) MSL, Peak Temp. - The Moisture Sensitivity Level rating according to the JEDEC industry standard classifications, and peak solder temperature.

(4) There may be additional marking, which relates to the logo, the lot trace code information, or the environmental category on the device.

(5) Multiple Device Markings will be inside parentheses. Only one Device Marking contained in parentheses and separated by a "~" will appear on a device. If a line is indented then it is a continuation of the previous line and the two combined represent the entire Device Marking for that device.

(6) Lead/Ball Finish - Orderable Devices may have multiple material finish options. Finish options are separated by a vertical ruled line. Lead/Ball Finish values may wrap to two lines if the finish value exceeds the maximum column width.

Important Information and Disclaimer:The information provided on this page represents TI's knowledge and belief as of the date that it is provided. TI bases its knowledge and belief on information provided by third parties, and makes no representation or warranty as to the accuracy of such information. Efforts are underway to better integrate information from third parties. TI has taken and continues to take reasonable steps to provide representative and accurate information but may not have conducted destructive testing or chemical analysis on incoming materials and chemicals. TI and TI suppliers consider certain information to be proprietary, and thus CAS numbers and other limited information may not be available for release.

In no event shall TI's liability arising out of such information exceed the total purchase price of the TI part(s) at issue in this document sold by TI to Customer on an annual basis.

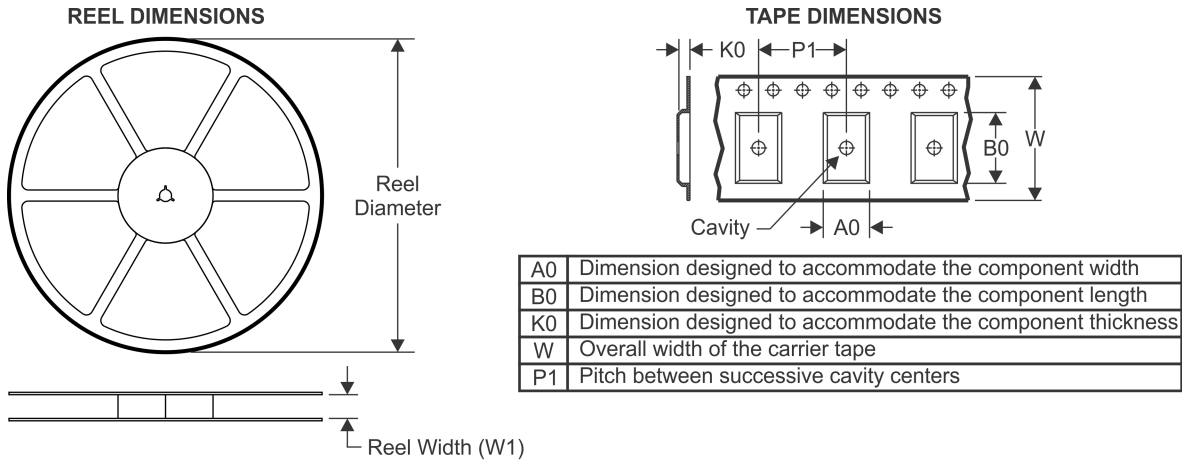
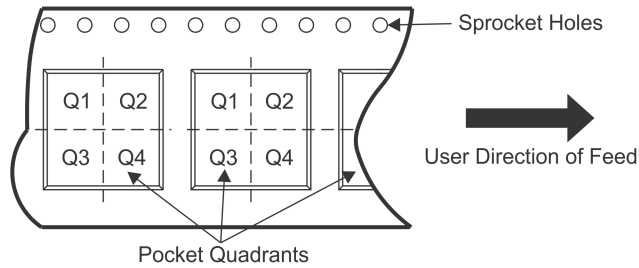
TAPE AND REEL INFORMATION

QUADRANT ASSIGNMENTS FOR PIN 1 ORIENTATION IN TAPE

*All dimensions are nominal

Device	Package Type	Package Drawing	Pins	SPQ	Reel Diameter (mm)	Reel Width W1 (mm)	A0 (mm)	B0 (mm)	K0 (mm)	P1 (mm)	W (mm)	Pin1 Quadrant
TPIC71008TDCARQ1	HTSSOP	DCA	48	2000	330.0	24.4	8.6	13.0	1.8	12.0	24.0	Q1

TAPE AND REEL BOX DIMENSIONS



*All dimensions are nominal

Device	Package Type	Package Drawing	Pins	SPQ	Length (mm)	Width (mm)	Height (mm)
TPIC71008TDCARQ1	HTSSOP	DCA	48	2000	350.0	350.0	43.0

MECHANICAL DATA

DCA (R-PDSO-G48)

PowerPAD™ PLASTIC SMALL-OUTLINE

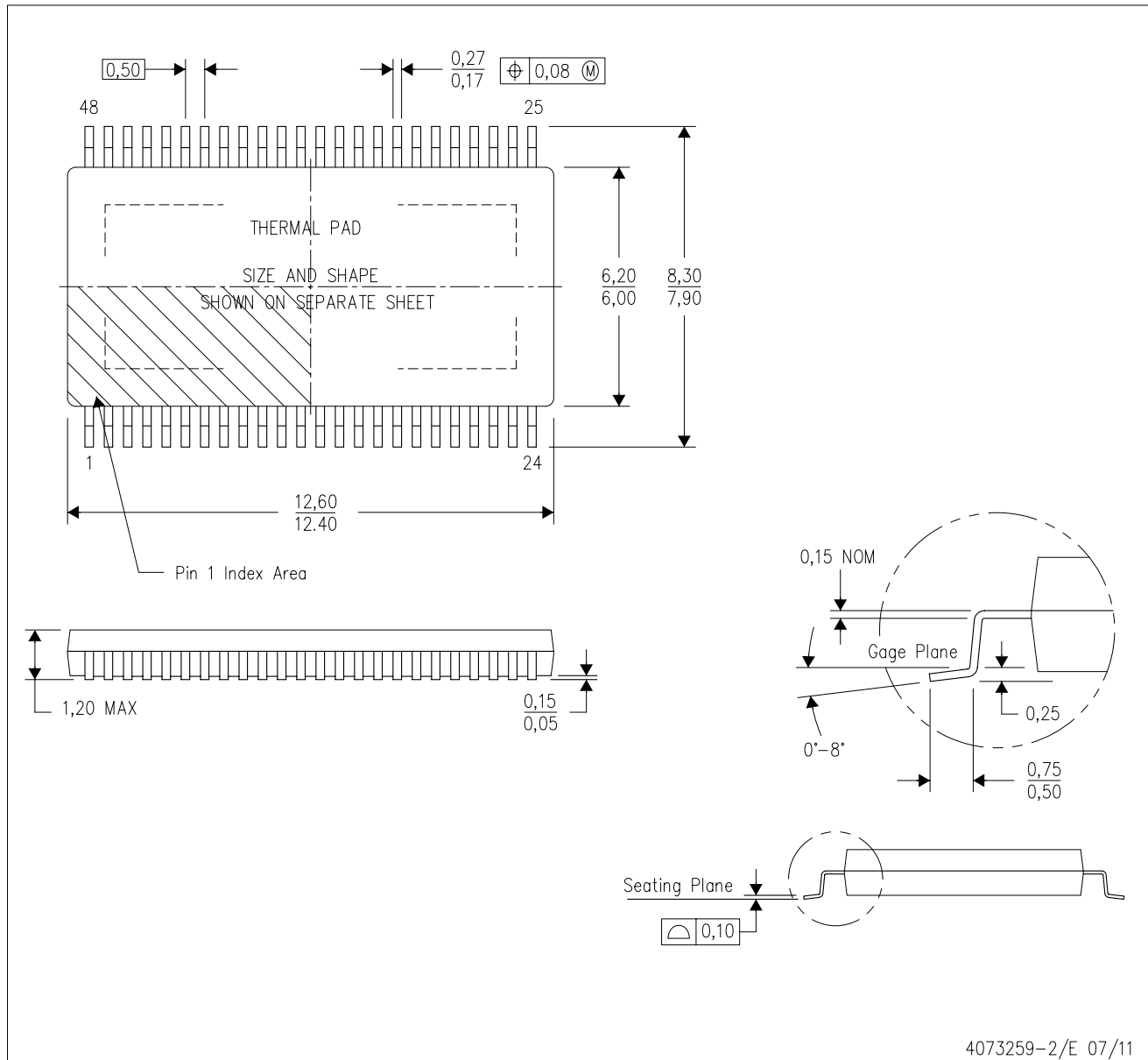

- NOTES:
- All linear dimensions are in millimeters. Dimensioning and tolerancing per ASME Y14.5M-1994.
 - This drawing is subject to change without notice.
 - Body dimensions do not include mold flash or protrusion not to exceed 0,15.
 - This package is designed to be soldered to a thermal pad on the board. Refer to Technical Brief, PowerPad Thermally Enhanced Package, Texas Instruments Literature No. SLMA002 for information regarding recommended board layout. This document is available at www.ti.com <<http://www.ti.com>>.
 - See the additional figure in the Product Data Sheet for details regarding the exposed thermal pad features and dimensions.
 - Falls within JEDEC MO-153

PowerPAD is a trademark of Texas Instruments.

THERMAL PAD MECHANICAL DATA

DCA (R-PDSO-G48)

PowerPAD™ PLASTIC SMALL OUTLINE

THERMAL INFORMATION

This PowerPAD™ package incorporates an exposed thermal pad that is designed to be attached to a printed circuit board (PCB). The thermal pad must be soldered directly to the PCB. After soldering, the PCB can be used as a heatsink. In addition, through the use of thermal vias, the thermal pad can be attached directly to the appropriate copper plane shown in the electrical schematic for the device, or alternatively, can be attached to a special heatsink structure designed into the PCB. This design optimizes the heat transfer from the integrated circuit (IC).

For additional information on the PowerPAD package and how to take advantage of its heat dissipating abilities, refer to Technical Brief, PowerPAD Thermally Enhanced Package, Texas Instruments Literature No. SLMA002 and Application Brief, PowerPAD Made Easy, Texas Instruments Literature No. SLMA004. Both documents are available at www.ti.com.

The exposed thermal pad dimensions for this package are shown in the following illustration.

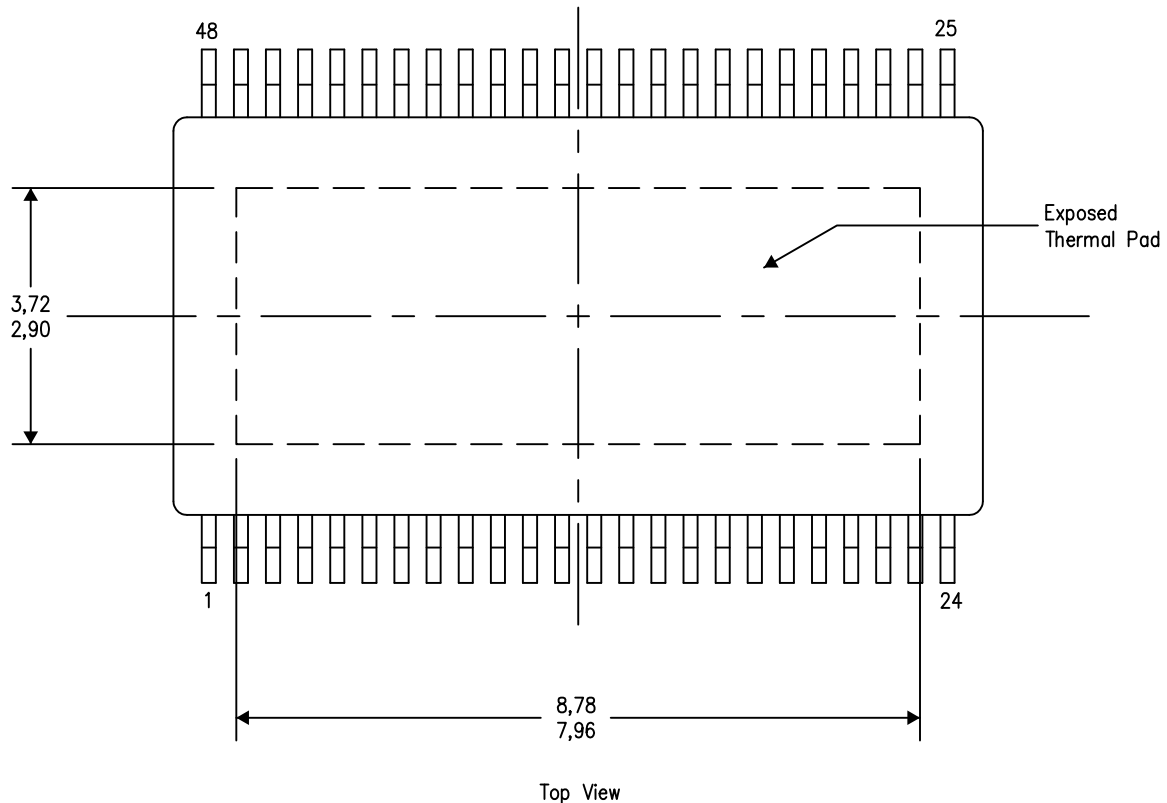

Exposed Thermal Pad Dimensions

4206320-7/S 11/14

NOTE: A. All linear dimensions are in millimeters

PowerPAD is a trademark of Texas Instruments.

IMPORTANT NOTICE AND DISCLAIMER

TI PROVIDES TECHNICAL AND RELIABILITY DATA (INCLUDING DATASHEETS), DESIGN RESOURCES (INCLUDING REFERENCE DESIGNS), APPLICATION OR OTHER DESIGN ADVICE, WEB TOOLS, SAFETY INFORMATION, AND OTHER RESOURCES "AS IS" AND WITH ALL FAULTS, AND DISCLAIMS ALL WARRANTIES, EXPRESS AND IMPLIED, INCLUDING WITHOUT LIMITATION ANY IMPLIED WARRANTIES OF MERCHANTABILITY, FITNESS FOR A PARTICULAR PURPOSE OR NON-INFRINGEMENT OF THIRD PARTY INTELLECTUAL PROPERTY RIGHTS.

These resources are intended for skilled developers designing with TI products. You are solely responsible for (1) selecting the appropriate TI products for your application, (2) designing, validating and testing your application, and (3) ensuring your application meets applicable standards, and any other safety, security, or other requirements. These resources are subject to change without notice. TI grants you permission to use these resources only for development of an application that uses the TI products described in the resource. Other reproduction and display of these resources is prohibited. No license is granted to any other TI intellectual property right or to any third party intellectual property right. TI disclaims responsibility for, and you will fully indemnify TI and its representatives against, any claims, damages, costs, losses, and liabilities arising out of your use of these resources.

TI's products are provided subject to TI's Terms of Sale (www.ti.com/legal/termsofsale.html) or other applicable terms available either on ti.com or provided in conjunction with such TI products. TI's provision of these resources does not expand or otherwise alter TI's applicable warranties or warranty disclaimers for TI products.

Mailing Address: Texas Instruments, Post Office Box 655303, Dallas, Texas 75265
Copyright © 2020, Texas Instruments Incorporated