

4

3

2

1

THIS DRAWING IS UNPUBLISHED. RELEASED FOR PUBLICATION 2009

© COPYRIGHT 2009 BY TYCO ELECTRONICS CORPORATION. ALL RIGHTS RESERVED.

LOC	DIST	REVISIONS			
P	LTR	DESCRIPTION	DATE	DWN	APVD
E	B	BA	NEW RELEASE	06-APR-10	MRS St.P

FOR FURTHER INFORMATION SEE DATA SHEET FOR
SERIES ES - HIGH POWER RESISTORS

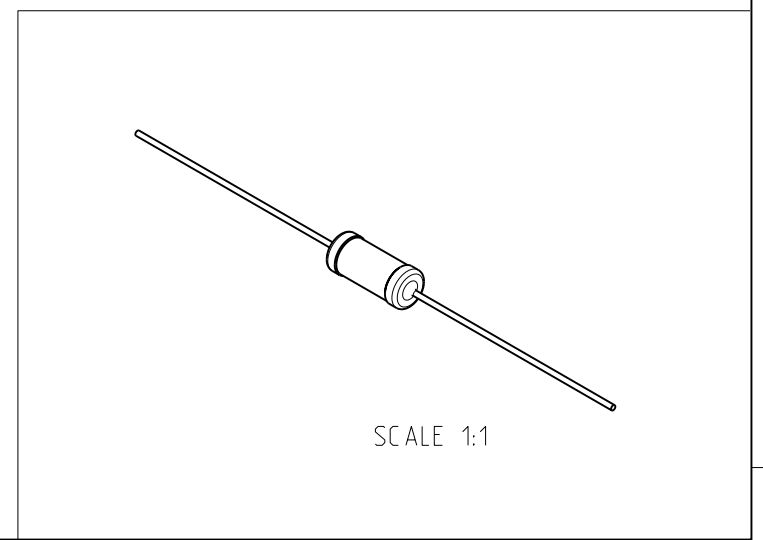
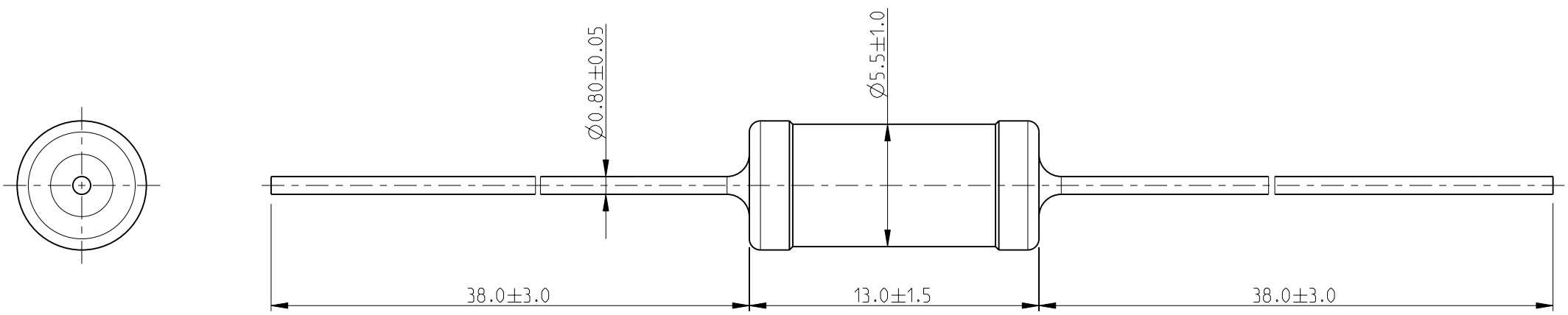

<small>THIS DRAWING IS A CONTROLLED DOCUMENT FOR TYCO ELECTRONICS CORPORATION IT IS SUBJECT TO CHANGE AND THE CONTROLLING ENGINEERING ORGANIZATION SHOULD BE CONTACTED FOR THE LATEST REVISION.</small>		DWN MAHARUDRA 06-APR-10 CHK ALLAN.P 06-APR-10 APVD STEPHEN.P 06-APR-10	Tyco Electronics Corporation Dorcan, Swindon, SN3 5HH	
DIMENSIONS: mm	TOLERANCES UNLESS OTHERWISE SPECIFIED: 0 PLC ±0.2 1 PLC ±0.1 2 PLC ±- 3 PLC ±- 4 PLC ±- ANGLES ±5°	PRODUCT SPEC - APPLICATION SPEC - WEIGHT -	NAME HIGH POWER RESISTORS SERIES ES3W	
MATERIAL -	FINISH -	SIZE A3	CAGE CODE 00779	DRAWING NO C-1879103
CUSTOMER DRAWING		SCALE 4:1	SHEET 1 OF 1	REV BA