

ASSEMBLY - VIEW FROM TOP

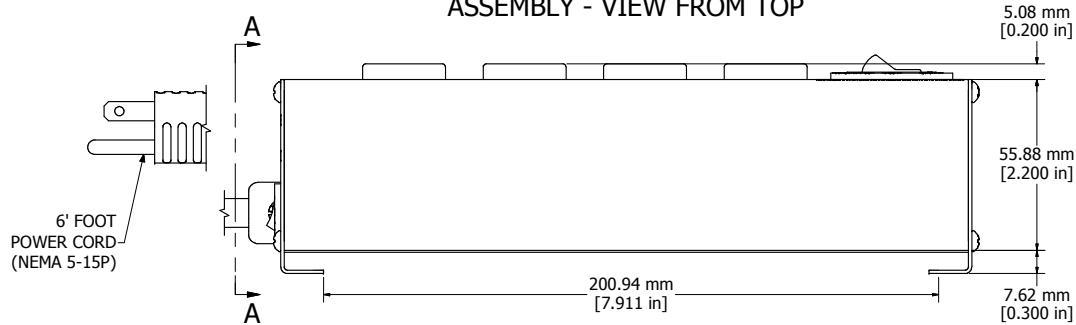

ASSEMBLY - VIEW FROM SIDE

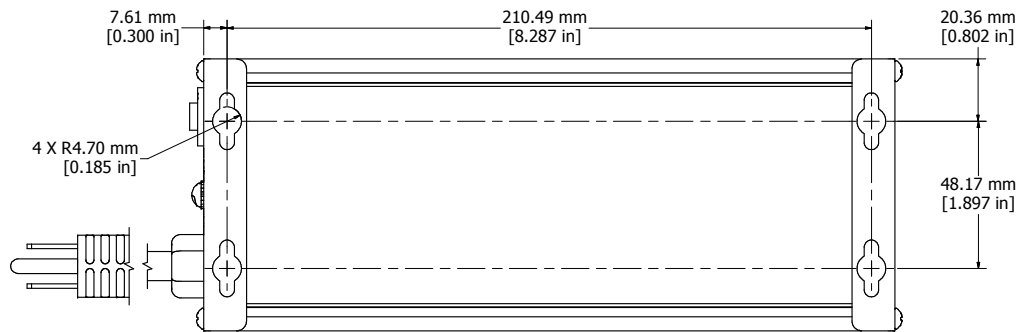

ASSEMBLY - VIEW FROM BOTTOM

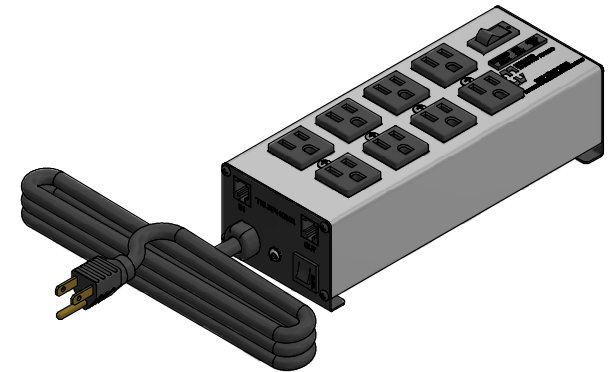

ISOMETRIC VIEW

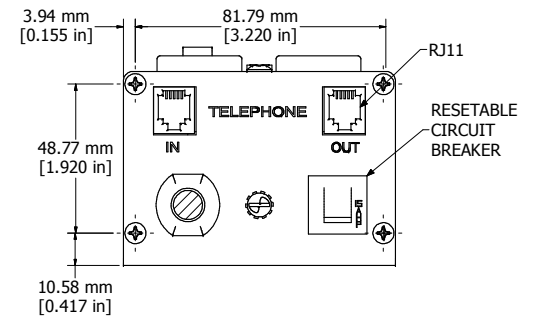

SECTION A-A

ZT2001-8

Finish - Sides - Black Painted Steel

Case - Aluminum Extrusion

Rated - 120 VAC, 60 Hz, 15 Amps

Approvals - CSA Certified Standards C22.2

(No. 21-95, 42-99) & 8-M1986

