

SUMMARY

Wires

Triax 1



Image is for illustrative purpose only

Series 0S
Termination type Male solder
IP rating 50
AWG wire size 0.00 - 0.00
Cable Ø 0.00 - 0.00 mm
Status active
Matching parts [FFA.0S.650.CTLC32Z](#)

Download

[Request a quote](#)

[Catalog](#)

TECHNICAL DETAILS

Mechanics

Shell Style/Model ERA*: Fixed receptacle, nut fixing
Keying Circular, male
Housing Material Brass (chrome plated [SAE AMS 2460]) shell and collet nut, nickel plated [SAE AMS QQ N 290] brass latch sleeve and mid pieces
Weight 4.84 g

Performance

Configuration 0S.650 : 1 Triax (50 Ohm)
Insulator T: PTFE
Rated Current 6 Amps

Specifications

Contact Type: Triaxial 50 Ohm (Solder)
Contact Dia.: 0.9 mm (0.035" in)
Vtest: 1200 V (AC), 1700 V (DC)
Impedance: 50 Ohm
VSWR: 1.03 + 0.34 * f/GHz
Cable type: RGT 178, RGT 174

Others

LEMO products and services are provided "as is". LEMO makes no warranties or representations with regard to LEMO product & services or use of them, express, implied or statutory, including for accuracy, completeness, or security. The user is fully responsible for his products and applications using LEMO components.

Endurance (Shell): 5000 mating cycles
 Temp (min / max): -55°C / +250°C
 Humidity (max): <=95% [at 60 deg C / 140 F]
 Vibration: 15 g [10 Hz - 2000 Hz]
 Shock Resistance: 100 g [6 ms]
 Climatical Category: 50/175/21
 Shielding (min): 75 dB (10 MHz)
 Shielding (min): 40 dB (1 GHz)
 Salt Spray Corrosion: >1000 hr

DRAWINGS

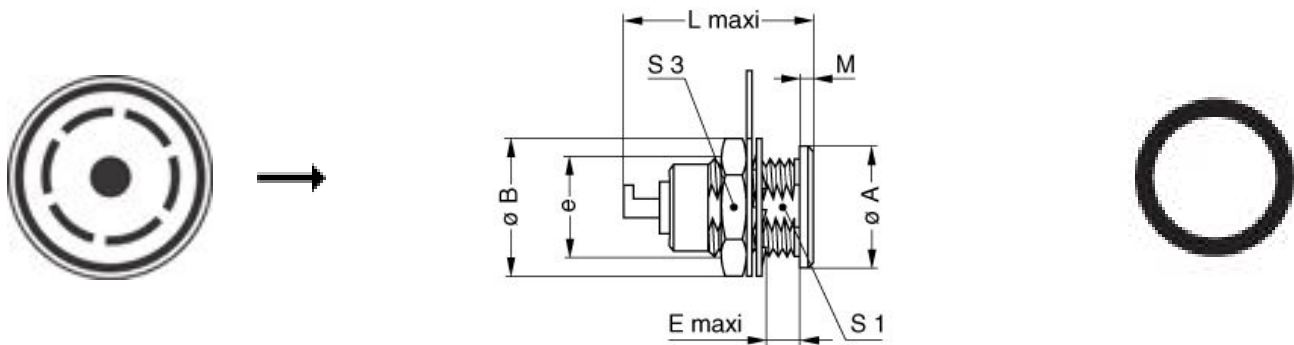

Dimensions

	A	B	E	L	M	S1	S3	e
mm.	10	12.5	7	18.5	1.2	8.2	11	M9x0.6
in.	0,39	0,49	0,28	0,73	0,05	0,32	0,43	

RECOMMENDED BY LEMO

Tools

Spanner wrench: [Socket for torque wrench DCM.05.M09.4](#)

LEMO products and services are provided "as is". LEMO makes no warranties or representations with regard to LEMO product & services or use of them, express, implied or statutory, including for accuracy, completeness, or security. The user is fully responsible for his products and applications using LEMO components.

LEMO products and services are provided "as is". LEMO makes no warranties or representations with regard to LEMO product & services or use of them, express, implied or statutory, including for accuracy, completeness, or security. The user is fully responsible for his products and applications using LEMO components.