

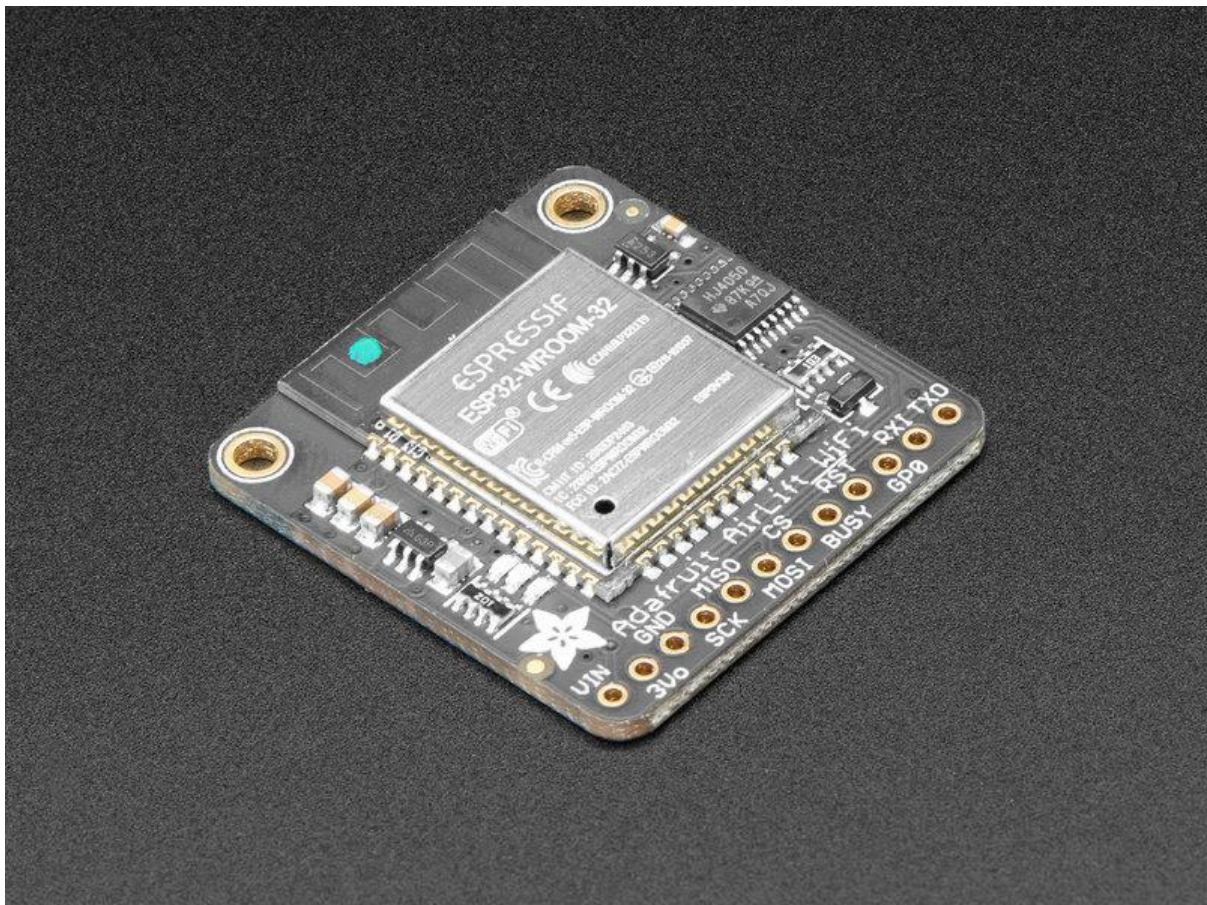

Adafruit AirLift - ESP32 WiFi Co-Processor Breakout

Created by Kattni Rembor



<https://learn.adafruit.com/adafruit-airlift-breakout>

Last updated on 2022-12-01 03:34:47 PM EST

Table of Contents

Overview	3
Pinouts	5
<ul style="list-style-type: none">• Power Pins• SPI & Control Pins• LEDs	
Assembly	8
<ul style="list-style-type: none">• Prepare the header strip:• Add the breakout board:• And Solder!	
CircuitPython WiFi	12
<ul style="list-style-type: none">• CircuitPython Microcontroller Pinout• CircuitPython Installation of ESP32SPI Library• CircuitPython Usage	
Internet Connect!	14
<ul style="list-style-type: none">• What's a secrets file?• Connect to WiFi• Requests• HTTP GET with Requests• HTTP POST with Requests• Advanced Requests Usage• WiFi Manager	
CircuitPython BLE	28
<ul style="list-style-type: none">• CircuitPython BLE UART Example• Update the AirLift Firmware• Install CircuitPython Libraries• Install the Adafruit Bluefruit LE Connect App• Copy and Adjust the Example Program• Talk to the AirLift via the Bluefruit LE Connect App	
Arduino WiFi	33
<ul style="list-style-type: none">• Arduino Wiring• Library Install• First Test• WiFi Connection Test• Secure Connection Example• JSON Parsing Demo• Adapting Other Examples	
Downloads	40
<ul style="list-style-type: none">• Files• Schematic• Fab Print	

Overview

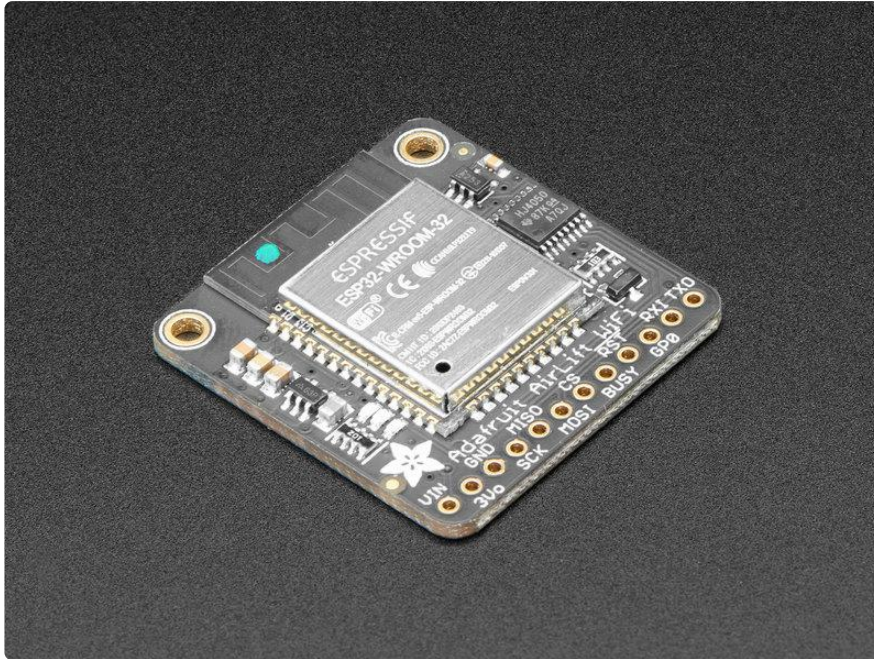

Give your plain ol' microcontroller project a lift with the Adafruit AirLift - a breakout board that lets you use the powerful ESP32 as a WiFi or BLE co-processor. You probably have your favorite microcontroller (like the ATmega328 or ATSAM51), awesome peripherals and lots of libraries. But it doesn't have WiFi or BLE built in! So lets give that chip a best friend, the ESP32. This chip can handle all the heavy lifting of connecting to a WiFi network and transferring data from a site, even if its using the latest TLS/SSL encryption (it has root certificates pre-burned in).

Having WiFi managed by a separate chip means your code is simpler, you don't have to cache socket data, or compile in & debug an SSL library. Send basic but powerful socket-based commands over 8MHz SPI for high speed data transfer. You can use 3V or 5V Arduino, any chip from the ATmega328 or up, although the '328 will not be able to do very complex tasks or buffer a lot of data. It also works great with CircuitPython, a SAMD51/Cortex M4 minimum required since we need a bunch of RAM. All you need is an SPI bus and 2 control pins plus a power supply that can provide up to 250mA during WiFi usage.

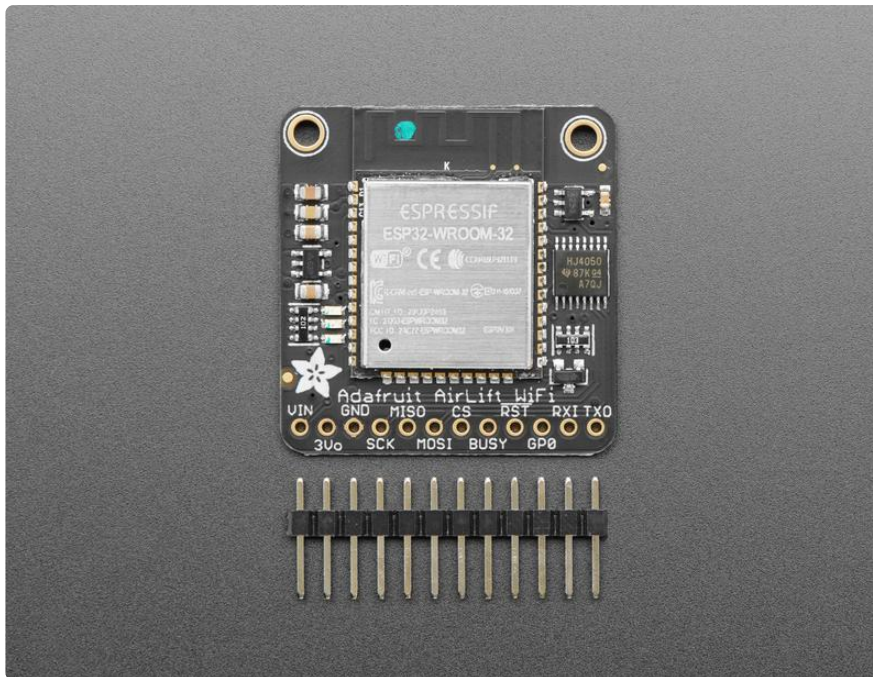

The ESP32 also supports BLE (Bluetooth Low Energy), though not simultaneously with WiFi. Many of our CircuitPython builds include native support for ESP32 BLE. You use a few control pins and the RXI and TXO pins to talk to the ESP32 when it's in BLE mode.

We placed an ESP32 module on a PCB with level shifting circuitry, a 3.3V regulator, and a tri-state chip for MOSI so you can share the SPI bus with other devices. Comes fully assembled and tested, pre-programmed with ESP32 SPI WiFi co-processor firmware that [you can use in CircuitPython to use this into a WiFi co-processor over SPI + 2 pins](#) (). We also toss in some header so you can solder it in and plug into a solderless breadboard.

[The firmware on board is a slight variant of the Arduino Wi-FiNINA core, which works great!](#) () At this time connection to Enterprise WiFi is not yet supported.

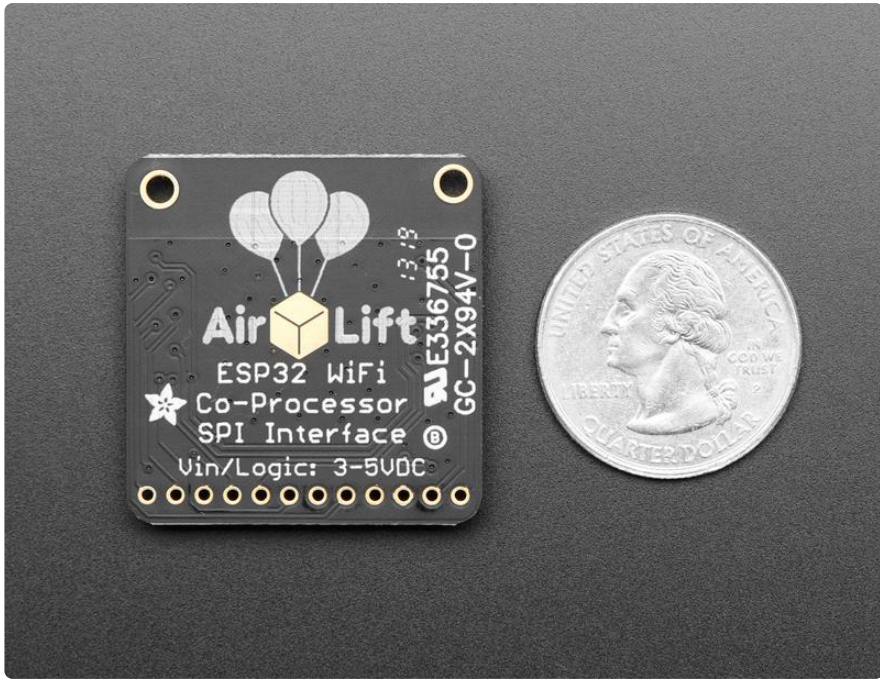

Pinouts

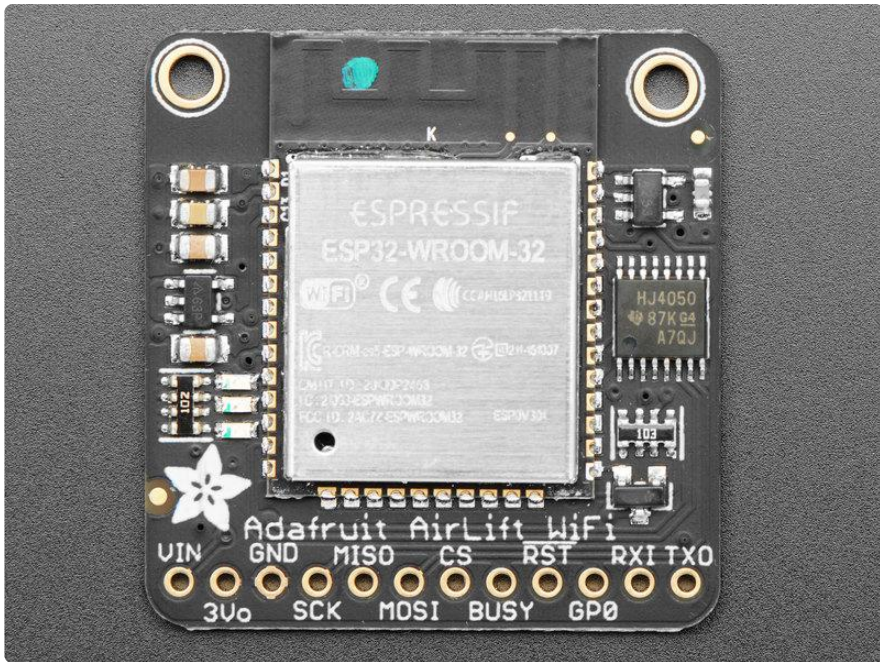

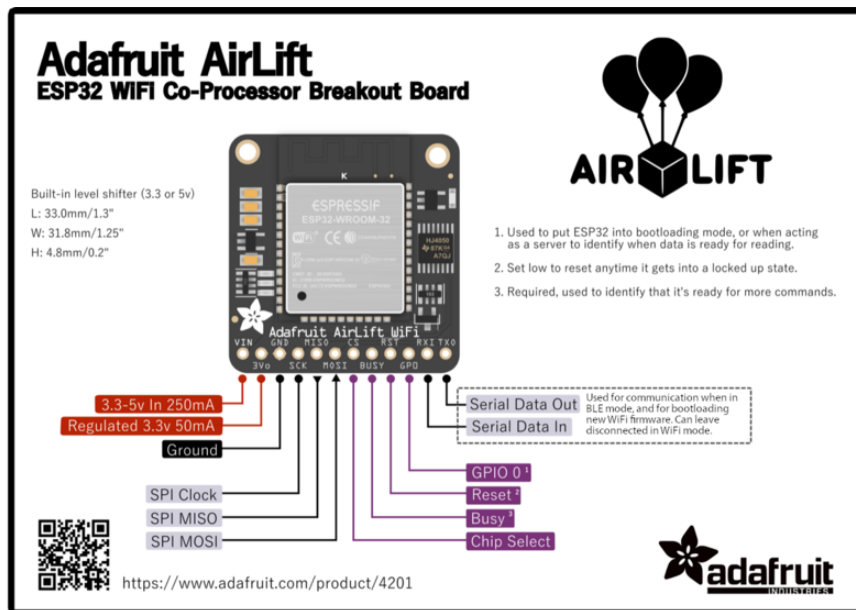

Power Pins

Starting from the left are the power in/out pins.

The ESP32 chip can use a lot of power when transmitting. Make sure your power source can handle up to 250mA spikes of current during transmits!

- VIN - This is the power input. Can be 3.3-5VDC, USE A POWER SOURCE THAT CAN HAPPILY SUPPLY 250mA, we will regulate this down to 3.3V safely! This is probably a VBAT or USB pin not a 3.3V regulated output.
- 3v0 - The output from the onboard 3.3V regulator, you can use up to ~50mA for other devices if you want to power them from the same chip
- GND - Power and logic ground.

SPI & Control Pins

To keep transfers speedy, we use SPI not UART Serial. Serial is too slow and hard to synchronize. This uses more pins but the experience is much better!

Classic SPI Pins:

- SCK - SPI Clock from your microcontroller, level shifted so can be 3-5V logic

- MISO - SPI Data from the AirLift to the microcontroller, this is 3.3V logic out, can be read by 3-5V logic. This is tri-stated when not selected, so you can share the SPI bus with other devices.
- MOSI- SPI Data to the AirLift from the microcontroller, level shifted so can be 3-5V logic
- CS - SPI Chip Select from the microcontroller to start sending commands to the AirLift, level shifted so can be 3-5V logic. Also used to choose WiFi or BLE on reset.

Required Control Pins:

- BUSY - this pin is an input from the AirLift, it will let us know when its ready for more commands to be sent. This is 3.3V logic out, can be read by 3-5V logic. This pin must be connected.
- !RESET - this pin is an output to the AirLift. Set low to put the AirLift into reset. You should use this pin, even though you might be able to run for a short while without it, it's essential to 'kick' the chip if it ever gets into a locked up state. Level shifted so can be 3-5V logic

Optional Control Pins:

- GP0 - this is the ESP32 GPIO0 pin, which is used to put it into bootloading mode. It is also used if you like when the ESP32 is acting as a server, to let you know data is ready for reading. It's not required in WiFi mode, so you can leave it disconnected. But you'll need to connect it for BLE mode.
- RXI & TXO - Serial data in and Serial data out, used for bootloading new firmware, and for communication when in BLE mode. Leave disconnected if not using BLE or when not uploading new WiFi firmware to the AirLift (which is a rare occurrence).

LEDs

There are 3 very tiny red, green and blue LEDs to the left of the ESP32, these are available in the Arduino library if you'd like to PWM them for a visual alert.

Assembly

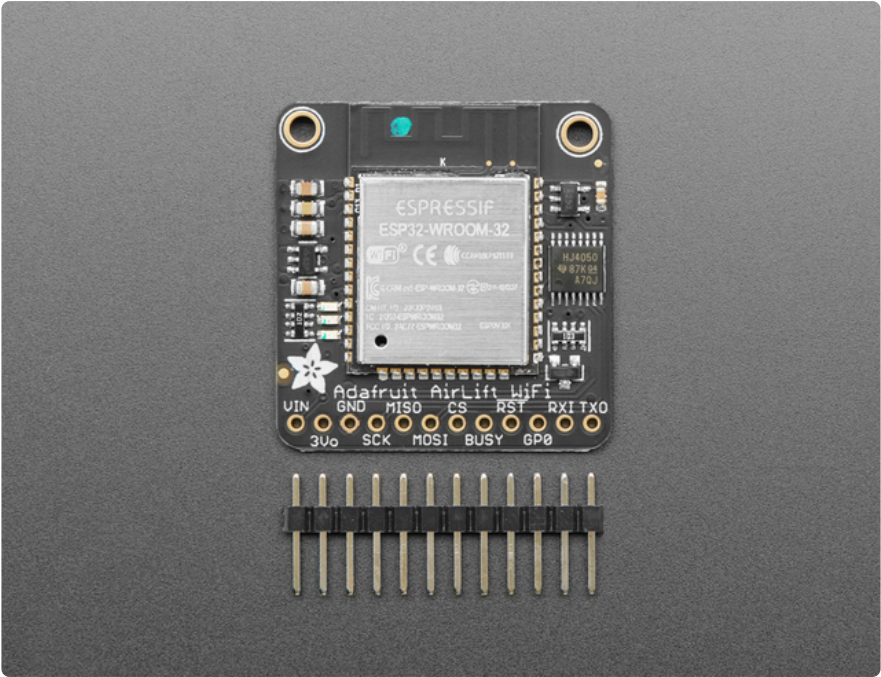

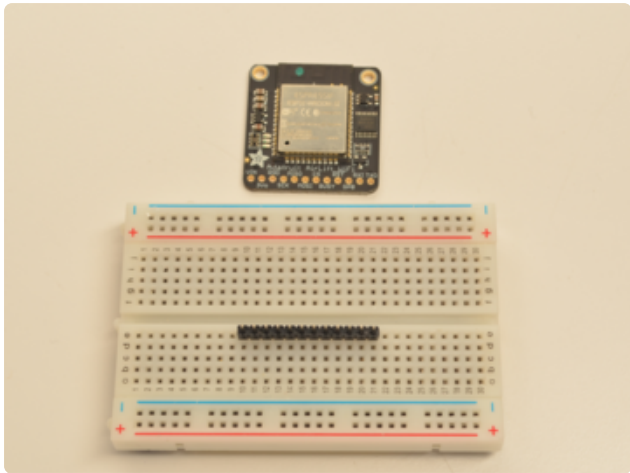
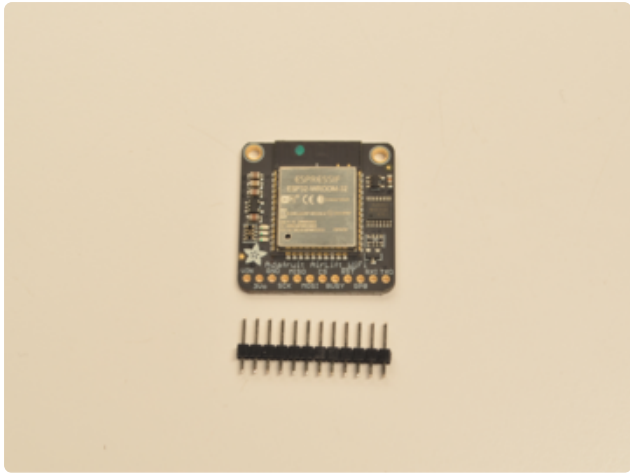
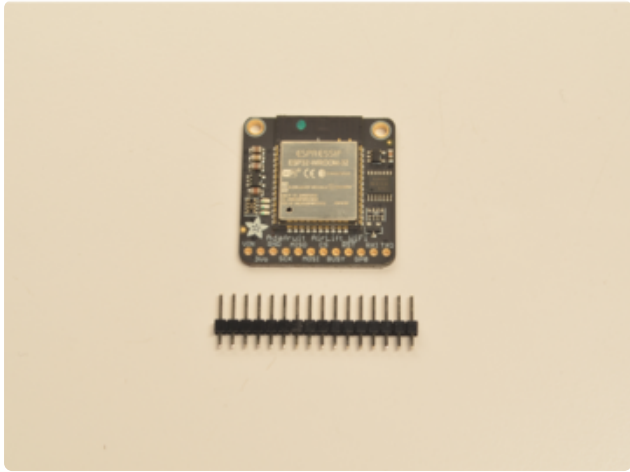

Prepare the header strip:

Cut the strip to length if necessary. It will be easier to solder if you insert it into a breadboard - long pins down

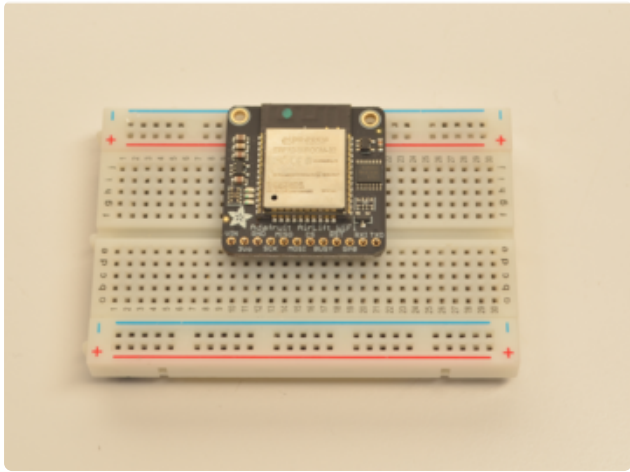

Add the breakout board:

Place the breakout board over the pins so that the short pins poke through the breakout pads

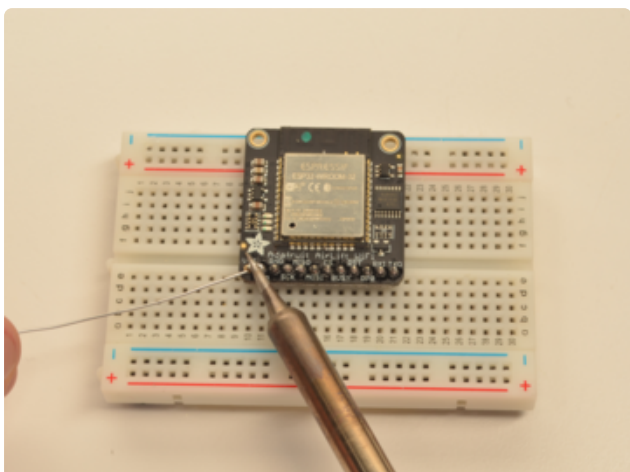
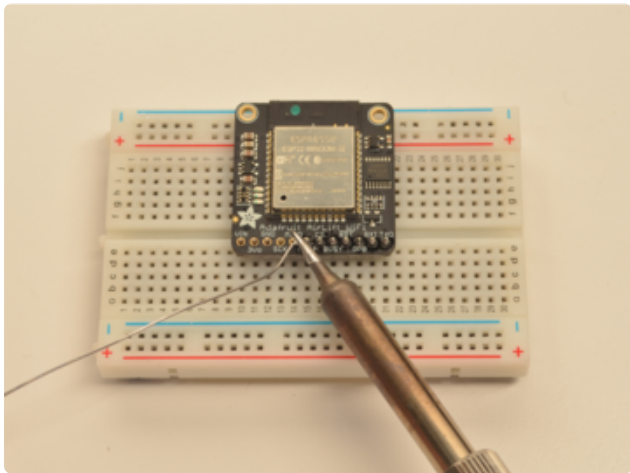
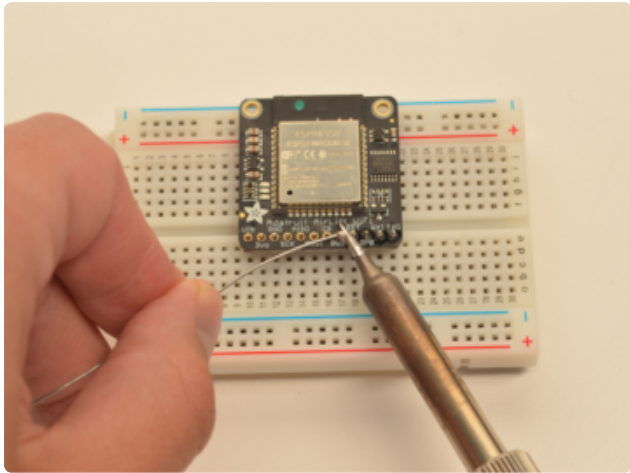
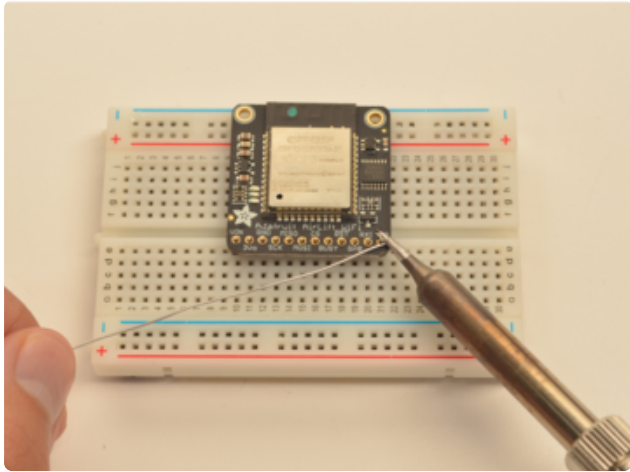

And Solder!

Be sure to solder all 12 pins for reliable electrical contact.

(For tips on soldering, be sure to check out our [Guide to Excellent Soldering \(\)](#)).

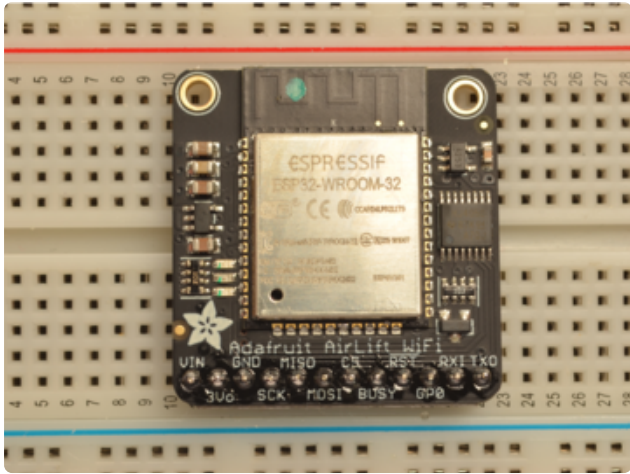

You're done! Check your solder joints visually and continue onto the next steps

CircuitPython WiFi

It's easy to use the Adafruit AirLift breakout with CircuitPython and the [Adafruit CircuitPython ESP32SPI \(\)](#) module. This module allows you to easily add WiFi to your project.

The ESP32SPI library requires a microcontroller with ~128KB of RAM or more. The SAMD21 will not work.

CircuitPython Microcontroller Pinout

First, wire up your AirLift as follows. The following example shows it wired to a Feather M4 using SPI:

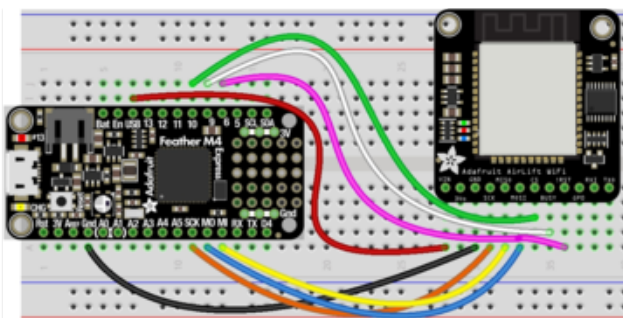

Board VIN to Feather USB
Board GND to Feather GND
Board SCK to Feather SCK
Board MISO to Feather MI
Board MOSI to Feather MO
Board CS to Feather D10
Board BUSY to Feather D9
Board !RST to Feather D6
You must use USB or VBAT for powering the AirLift Breakout!

CircuitPython Installation of ESP32SPI Library

You'll need to install the [Adafruit CircuitPython ESP32SPI \(\)](#) library on your CircuitPython board.

First make sure you are running the [latest version of Adafruit CircuitPython \(\)](#) for your board.

Next you'll need to install the necessary libraries to use the hardware--carefully follow the steps to find and install these libraries from [Adafruit's CircuitPython library bundle \(\)](#). Our CircuitPython starter guide has [a great page on how to install the library bundle \(\)](#).

You can manually install the necessary libraries from the bundle:

- adafruit_esp32spi
- adafruit_requests.mpy
- adafruit_bus_device

Before continuing make sure your board's lib folder or root filesystem has the adafruit_esp32spi, adafruit_requests.mpy, and adafruit_bus_device files and folders copied over.

Next [make sure you are set up to connect to the serial console \(\)](#)

CircuitPython Usage

Copy the following code to your code.py file on your microcontroller:

```
import board
import busio
from digitalio import DigitalInOut

from adafruit_esp32spi import adafruit_esp32spi
import adafruit_requests as requests

print("ESP32 SPI hardware test")

esp32_cs = DigitalInOut(board.D10)
esp32_ready = DigitalInOut(board.D9)
esp32_reset = DigitalInOut(board.D7)

spi = busio.SPI(board.SCK, board.MOSI, board.MISO)
```

```

esp = adafruit_esp32spi.ESP_SPIcontrol(spi, esp32_cs, esp32_ready, esp32_reset)

if esp.status == adafruit_esp32spi.WL_IDLE_STATUS:
    print("ESP32 found and in idle mode")
print("Firmware vers.", esp.firmware_version)
print("MAC addr:", [hex(i) for i in esp.MAC_address])

for ap in esp.scan_networks():
    print("\t%s\t\tRSSI: %d" % (str(ap['ssid'], 'utf-8'), ap['rssi']))

print("Done!")

```

[Connect to the serial console \(\)](#) to see the output. It should look something like the following:

```

code.py output:
ESP32 SPI hardware test
ESP32 found and in idle mode
Firmware vers. bytearray(b'1.3.0\x00')
MAC addr: ['0xbd', '0xb0', '0xe', '0x33', '0x4f', '0xc4']
Get scan
  Adafruit          RSSI: -50
  Adafruit          RSSI: -57
  ESP_88EF6C       RSSI: -61
  consulatewireless RSSI: -70
  Adafruit          RSSI: -71
  Consulate Guest  RSSI: -71
  consulatewireless RSSI: -72
  Consulate Guest  RSSI: -73
  consulatewireless RSSI: -74
  ndm-studiompro2-hotspot RSSI: -74
Done!

Press any key to enter the REPL. Use CTRL-D to reload. █

```

Make sure you see the same output! If you don't, check your wiring. Note that we've changed the pinout in the code example above to reflect the CircuitPython Microcontroller Pinout at the top of this page.

Once you've succeeded, continue onto the next page!

If you can read the Firmware and MAC address but fails on scanning SSIDs, check your power supply, you may be running out of juice to the ESP32 and it's resetting

Internet Connect!

Once you have CircuitPython setup and libraries installed we can get your board connected to the Internet.

To get connected, you will need to start by creating a secrets file.

What's a secrets file?

We expect people to share tons of projects as they build CircuitPython WiFi widgets. What we want to avoid is people accidentally sharing their passwords or secret tokens and API keys. So, we designed all our examples to use a `secrets.py` file, that is in your CIRCUITPY drive, to hold secret/private/custom data. That way you can share your main project without worrying about accidentally sharing private stuff.

Your secrets.py file should look like this:

```
# This file is where you keep secret settings, passwords, and tokens!  
# If you put them in the code you risk committing that info or sharing it  
  
secrets = {  
    'ssid' : 'home ssid',  
    'password' : 'my password',  
    'timezone' : "America/New_York", # http://worldtimeapi.org/timezones  
    'github_token' : 'fawfj23rakjnfawiefa',  
    'hackaday_token' : 'h4xx0rs3kret',  
}
```

Inside is a python dictionary named secrets with a line for each entry. Each entry has an entry name (say `'ssid'`) and then a colon to separate it from the entry key `'home ssid'` and finally a comma ,

At a minimum you'll need the `ssid` and `password` for your local WiFi setup. As you make projects you may need more tokens and keys, just add them one line at a time. See for example other tokens such as one for accessing github or the hackaday API. Other non-secret data like your timezone can also go here, just cause its called secrets doesn't mean you can't have general customization data in there!

For the correct time zone string, look at [http://worldtimeapi.org/timezones \(\)](http://worldtimeapi.org/timezones) and remember that if your city is not listed, look for a city in the same time zone, for example Boston, New York, Philadelphia, Washington DC, and Miami are all on the same time as New York.

Of course, don't share your secrets.py - keep that out of GitHub, Discord or other project-sharing sites.

Connect to WiFi

OK now you have your secrets setup - you can connect to the Internet using the ESP32SPI and the Requests modules.

First make sure you are running the [latest version of Adafruit CircuitPython \(\)](#) for your board.

Next you'll need to install the necessary libraries to use the hardware--carefully follow the steps to find and install these libraries from [Adafruit's CircuitPython library bundle \(\)](#). Our introduction guide has [a great page on how to install the library bundle \(\)](#) for both express and non-express boards.

Remember for non-express boards like the, you'll need to manually install the necessary libraries from the bundle:

- adafruit_bus_device
- adafruit_esp32_spi
- adafruit_requests
- neopixel

Before continuing make sure your board's lib folder or root filesystem has the above files copied over.

Next [connect to the board's serial REPL \(\)](#) so you are at the CircuitPython >>> prompt.

Into your `lib` folder. Once that's done, load up the following example using Mu or your favorite editor:

```
# SPDX-FileCopyrightText: 2019 ladyada for Adafruit Industries
# SPDX-License-Identifier: MIT

import board
import busio
from digitalio import DigitalInOut
import adafruit_requests as requests
import adafruit_esp32spi.adafruit_esp32spi_socket as socket
from adafruit_esp32spi import adafruit_esp32spi

# Get wifi details and more from a secrets.py file
try:
    from secrets import secrets
except ImportError:
    print("WiFi secrets are kept in secrets.py, please add them there!")
    raise

print("ESP32 SPI webclient test")
```



```

TEXT_URL = "http://wifitest.adafruit.com/testwifi/index.html"
JSON_URL = "http://api.coindesk.com/v1/bpi/currentprice/USD.json"

# If you are using a board with pre-defined ESP32 Pins:
esp32_cs = DigitalInOut(board.ESP_CS)
esp32_ready = DigitalInOut(board.ESP_BUSY)
esp32_reset = DigitalInOut(board.ESP_RESET)

# If you have an AirLift Shield:
# esp32_cs = DigitalInOut(board.D10)
# esp32_ready = DigitalInOut(board.D7)
# esp32_reset = DigitalInOut(board.D5)

# If you have an AirLift Featherwing or ItsyBitsy AirLift:
# esp32_cs = DigitalInOut(board.D13)
# esp32_ready = DigitalInOut(board.D11)
# esp32_reset = DigitalInOut(board.D12)

# If you have an externally connected ESP32:
# NOTE: You may need to change the pins to reflect your wiring
# esp32_cs = DigitalInOut(board.D9)
# esp32_ready = DigitalInOut(board.D10)
# esp32_reset = DigitalInOut(board.D5)

spi = busio.SPI(board.SCK, board.MOSI, board.MISO)
esp = adafruit_esp32spi.ESP_SPIcontrol(spi, esp32_cs, esp32_ready, esp32_reset)

requests.set_socket(socket, esp)

if esp.status == adafruit_esp32spi.WL_IDLE_STATUS:
    print("ESP32 found and in idle mode")
print("Firmware vers.", esp.firmware_version)
print("MAC addr:", [hex(i) for i in esp.MAC_address])

for ap in esp.scan_networks():
    print("\t%s\t\tRSSI: %d" % (str(ap["ssid"], "utf-8"), ap["rssi"]))

print("Connecting to AP...")
while not esp.is_connected:
    try:
        esp.connect_AP(secrets["ssid"], secrets["password"])
    except OSError as e:
        print("could not connect to AP, retrying: ", e)
        continue
print("Connected to", str(esp.ssid, "utf-8"), "\tRSSI:", esp.rssi)
print("My IP address is", esp.pretty_ip(esp.ip_address))
print(
    "IP lookup adafruit.com: %s" %
    esp.pretty_ip(esp.get_host_by_name("adafruit.com"))
)
print("Ping google.com: %d ms" % esp.ping("google.com"))

# esp.debug = True
print("Fetching text from", TEXT_URL)
r = requests.get(TEXT_URL)
print("-" * 40)
print(r.text)
print("-" * 40)
r.close()

print()
print("Fetching json from", JSON_URL)
r = requests.get(JSON_URL)
print("-" * 40)
print(r.json())
print("-" * 40)
r.close()

```

```
print("Done!")
```

And save it to your board, with the name `code.py`.

You may need to change the `esp32_cs`, `esp32_ready` and `esp32_reset` pins in the code to match your hardware's pinout.

Then go down to this line

```
esp.connect_AP(b'MY_SSID_NAME', b'MY_SSID_PASSWORD')
```

and change `MY_SSID_NAME` and `MY_SSID_PASSWORD` to your access point name and password, keeping them within the " quotes. (This example doesn't use the secrets' file, but its also very stand-alone so if other things seem to not work you can always re-load this. You should get something like the following:

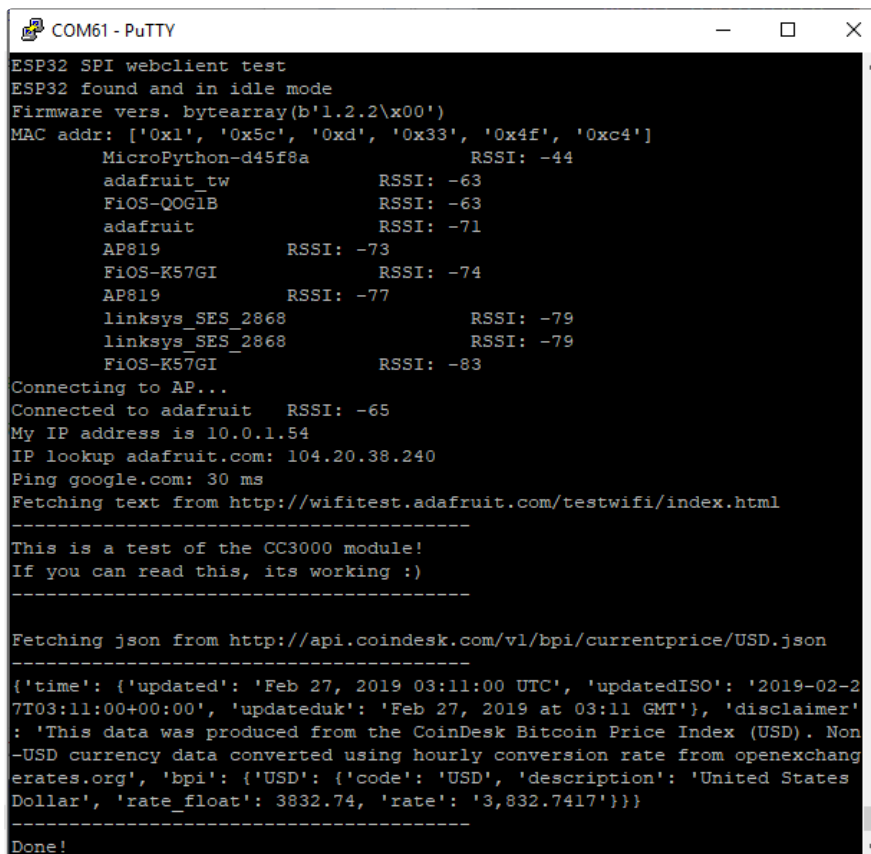

```
COM61 - PuTTY
ESP32 SPI webclient test
ESP32 found and in idle mode
Firmware vers. bytearray(b'1.2.2\x00')
MAC addr: ['0x1', '0x5c', '0xd', '0x33', '0x4f', '0xc4']
MicroPython-d45f8a      RSSI: -44
adafruit_tw            RSSI: -63
FIOS-QOGLB             RSSI: -63
adafruit               RSSI: -71
AP819                  RSSI: -73
FIOS-K57GI             RSSI: -74
AP819                  RSSI: -77
linksys_SES_2868       RSSI: -79
linksys_SES_2868       RSSI: -79
FIOS-K57GI             RSSI: -83
Connecting to AP...
Connected to adafruit  RSSI: -65
My IP address is 10.0.1.54
IP lookup adafruit.com: 104.20.38.240
Ping google.com: 30 ms
Fetching text from http://wifitest.adafruit.com/testwifi/index.html
-----
This is a test of the CC3000 module!
If you can read this, its working :)
-----
Fetching json from http://api.coindesk.com/v1/bpi/currentprice/USD.json
-----
{'time': {'updated': 'Feb 27, 2019 03:11:00 UTC', 'updatedISO': '2019-02-27T03:11:00+00:00', 'updateduk': 'Feb 27, 2019 at 03:11 GMT'}, 'disclaimer': 'This data was produced from the CoinDesk Bitcoin Price Index (USD). Non-USD currency data converted using hourly conversion rate from openexchangesrates.org', 'bpi': {'USD': {'code': 'USD', 'description': 'United States Dollar', 'rate_float': 3832.74, 'rate': '3,832.7417'}}}
-----
Done!
```

In order, the example code...

Initializes the ESP32 over SPI using the SPI port and 3 control pins:

```
esp32_cs = DigitalInOut(board.ESP_CS)
esp32_ready = DigitalInOut(board.ESP_BUSY)
```

```
esp32_reset = DigitalInOut(board.ESP_RESET)

spi = busio.SPI(board.SCK, board.MOSI, board.MISO)
esp = adafruit_esp32spi.ESP_SPIcontrol(spi, esp32_cs, esp32_ready, esp32_reset)
```

Tells our `requests` library the type of socket we're using (socket type varies by connectivity type - we'll be using the `adafruit_esp32spi_socket` for this example). We'll also set the interface to an `esp` object. This is a little bit of a hack, but it lets us use `requests` like CPython does.

```
requests.set_socket(socket, esp)
```

Verifies an ESP32 is found, checks the firmware and MAC address

```
if esp.status == adafruit_esp32spi.WL_IDLE_STATUS:
    print("ESP32 found and in idle mode")
print("Firmware vers.", esp.firmware_version)
print("MAC addr:", [hex(i) for i in esp.MAC_address])
```

Performs a scan of all access points it can see and prints out the name and signal strength:

```
for ap in esp.scan_networks():
    print("\t%s\t\tRSSI: %d" % (str(ap['ssid'], 'utf-8'), ap['rssi']))
```

Connects to the AP we've defined here, then prints out the local IP address, attempts to do a domain name lookup and ping google.com to check network connectivity (note sometimes the ping fails or takes a while, this isn't a big deal)

```
print("Connecting to AP...")
esp.connect_AP(b'MY_SSID_NAME', b'MY_SSID_PASSWORD')
print("Connected to", str(esp.ssid, 'utf-8'), "\tRSSI:", esp.rssi)
print("My IP address is", esp.pretty_ip(esp.ip_address))
print("IP lookup adafruit.com: %s" %
      esp.pretty_ip(esp.get_host_by_name("adafruit.com")))
print("Ping google.com: %d ms" % esp.ping("google.com"))
```

OK now we're getting to the really interesting part. With a SAMD51 or other large-RAM (well, over 32 KB) device, we can do a lot of neat tricks. Like for example we can implement an interface a lot like `requests()` - which makes getting data really really easy

To read in all the text from a web URL call `requests.get` - you can pass in `https` URLs for SSL connectivity

```

TEXT_URL = "http://wifitest.adafruit.com/testwifi/index.html"
print("Fetching text from", TEXT_URL)
r = requests.get(TEXT_URL)
print('- '*40)
print(r.text)
print('- '*40)
r.close()

```

Or, if the data is in structured JSON, you can get the json pre-parsed into a Python dictionary that can be easily queried or traversed. (Again, only for nRF52840, M4 and other high-RAM boards)

```

JSON_URL = "http://api.coindesk.com/v1/bpi/currentprice/USD.json"
print("Fetching json from", JSON_URL)
r = requests.get(JSON_URL)
print('- '*40)
print(r.json())
print('- '*40)
r.close()

```

Requests

We've written a [requests-like \(\)](#) library for web interfacing named [Adafruit_CircuitPython_on_Requests \(\)](#). This library allows you to send HTTP/1.1 requests without "crafting" them and provides helpful methods for parsing the response from the server.

Here's an example of using Requests to perform GET and POST requests to a server.

```

# SPDX-FileCopyrightText: 2021 ladyada for Adafruit Industries
# SPDX-License-Identifier: MIT

# adafruit_requests usage with an esp32spi_socket
import board
import busio
from digitalio import DigitalInOut
import adafruit_esp32spi.adafruit_esp32spi_socket as socket
from adafruit_esp32spi import adafruit_esp32spi
import adafruit_requests as requests

# Add a secrets.py to your filesystem that has a dictionary called secrets with
"ssid" and
# "password" keys with your WiFi credentials. DO NOT share that file or commit it
into Git or other
# source control.
# pylint: disable=no-name-in-module,wrong-import-order
try:
    from secrets import secrets
except ImportError:
    print("WiFi secrets are kept in secrets.py, please add them there!")
    raise

# If you are using a board with pre-defined ESP32 Pins:
esp32_cs = DigitalInOut(board.ESP_CS)
esp32_ready = DigitalInOut(board.ESP_BUSY)
esp32_reset = DigitalInOut(board.ESP_RESET)

```

```

# If you have an externally connected ESP32:
# esp32_cs = DigitalInOut(board.D9)
# esp32_ready = DigitalInOut(board.D10)
# esp32_reset = DigitalInOut(board.D5)

# If you have an AirLift Featherwing or ItsyBitsy AirLift:
# esp32_cs = DigitalInOut(board.D13)
# esp32_ready = DigitalInOut(board.D11)
# esp32_reset = DigitalInOut(board.D12)

spi = busio.SPI(board.SCK, board.MOSI, board.MISO)
esp = adafruit_esp32spi.ESP_SPIcontrol(spi, esp32_cs, esp32_ready, esp32_reset)

print("Connecting to AP...")
while not esp.is_connected:
    try:
        esp.connect_AP(secrets["ssid"], secrets["password"])
    except RuntimeError as e:
        print("could not connect to AP, retrying: ", e)
        continue
print("Connected to", str(esp.ssid, "utf-8"), "\tRSSI:", esp.rssi)

# Initialize a requests object with a socket and esp32spi interface
socket.set_interface(esp)
requests.set_socket(socket, esp)

TEXT_URL = "http://wifitest.adafruit.com/testwifi/index.html"
JSON_GET_URL = "https://httpbin.org/get"
JSON_POST_URL = "https://httpbin.org/post"

print("Fetching text from %s" % TEXT_URL)
response = requests.get(TEXT_URL)
print("-" * 40)

print("Text Response: ", response.text)
print("-" * 40)
response.close()

print("Fetching JSON data from %s" % JSON_GET_URL)
response = requests.get(JSON_GET_URL)
print("-" * 40)

print("JSON Response: ", response.json())
print("-" * 40)
response.close()

data = "31F"
print("POSTing data to {0}: {1}".format(JSON_POST_URL, data))
response = requests.post(JSON_POST_URL, data=data)
print("-" * 40)

json_resp = response.json()
# Parse out the 'data' key from json_resp dict.
print("Data received from server:", json_resp["data"])
print("-" * 40)
response.close()

json_data = {"Date": "July 25, 2019"}
print("POSTing data to {0}: {1}".format(JSON_POST_URL, json_data))
response = requests.post(JSON_POST_URL, json=json_data)
print("-" * 40)

json_resp = response.json()
# Parse out the 'json' key from json_resp dict.
print("JSON Data received from server:", json_resp["json"])
print("-" * 40)
response.close()

```

The code first sets up the ESP32SPI interface. Then, it initializes a `request` object using an ESP32 `socket` and the `esp` object.

```
import board
import busio
from digitalio import DigitalInOut
import adafruit_esp32spi.adafruit_esp32spi_socket as socket
from adafruit_esp32spi import adafruit_esp32spi
import adafruit_requests as requests

# If you have an externally connected ESP32:
esp32_cs = DigitalInOut(board.D9)
esp32_ready = DigitalInOut(board.D10)
esp32_reset = DigitalInOut(board.D5)

spi = busio.SPI(board.SCK, board.MOSI, board.MISO)
esp = adafruit_esp32spi.ESP_SPIcontrol(spi, esp32_cs, esp32_ready, esp32_reset)

print("Connecting to AP...")
while not esp.is_connected:
    try:
        esp.connect_AP(b'MY_SSID_NAME', b'MY_SSID_PASSWORD')
    except RuntimeError as e:
        print("could not connect to AP, retrying: ",e)
        continue
print("Connected to", str(esp.ssid, 'utf-8'), "\tRSSI:", esp.rssi)

# Initialize a requests object with a socket and esp32spi interface
requests.set_socket(socket, esp)
```

Make sure to set the ESP32 pinout to match your AirLift breakout's connection:

```
esp32_cs = DigitalInOut(board.D9)
esp32_ready = DigitalInOut(board.D10)
esp32_reset = DigitalInOut(board.D5)
```

HTTP GET with Requests

The code makes a HTTP GET request to Adafruit's WiFi testing website - <http://wifitest.adafruit.com/testwifi/index.html> ().

To do this, we'll pass the URL into `requests.get()`. We're also going to save the response from the server into a variable named `response`.

While we requested data from the server, we'd what the server responded with. Since we already saved the server's `response`, we can read it back. Luckily for us, `request` s automatically decodes the server's response into human-readable text, you can read it back by calling `response.text`.

Lastly, we'll perform a bit of cleanup by calling `response.close()`. This closes, deletes, and collect's the response's data.

```

    print("Fetching text from %s"%TEXT_URL)
    response = requests.get(TEXT_URL)
    print('- '*40)

    print("Text Response: ", response.text)
    print('- '*40)
    response.close()

```

While some servers respond with text, some respond with json-formatted data consisting of attribute–value pairs.

CircuitPython_Requests can convert a JSON-formatted response from a server into a CPython **dict**. object.

We can also fetch and parse json data. We'll send a HTTP get to a url we know returns a json-formatted response (instead of text data).

Then, the code calls **response.json()** to convert the response to a CPython **dict**.

```

    print("Fetching JSON data from %s"%JSON_GET_URL)
    response = requests.get(JSON_GET_URL)
    print('- '*40)

    print("JSON Response: ", response.json())
    print('- '*40)
    response.close()

```

HTTP POST with Requests

Requests can also POST data to a server by calling the **requests.post** method, passing it a **data** value.

```

data = '31F'
print("POSTing data to {0}: {1}".format(JSON_POST_URL, data))
response = requests.post(JSON_POST_URL, data=data)
print('- '*40)

json_resp = response.json()
# Parse out the 'data' key from json_resp dict.
print("Data received from server:", json_resp['data'])
print('- '*40)
response.close()

```

You can also post json-formatted data to a server by passing **json** data into the **requests.post** method.

```

json_data = {"Date" : "July 25, 2019"}
print("POSTing data to {0}: {1}".format(JSON_POST_URL, json_data))
response = requests.post(JSON_POST_URL, json=json_data)
print('-'*40)

json_resp = response.json()
# Parse out the 'json' key from json_resp dict.
print("JSON Data received from server:", json_resp['json'])
print('-'*40)
response.close()

```

Advanced Requests Usage

Want to send custom HTTP headers, parse the response as raw bytes, or handle a response's http status code in your CircuitPython code?

We've written an example to show advanced usage of the requests module below.

```

# SPDX-FileCopyrightText: 2021 ladyada for Adafruit Industries
# SPDX-License-Identifier: MIT

import board
import busio
from digitalio import DigitalInOut
import adafruit_esp32spi.adafruit_esp32spi_socket as socket
from adafruit_esp32spi import adafruit_esp32spi
import adafruit_requests as requests

# Add a secrets.py to your filesystem that has a dictionary called secrets with
"ssid" and
# "password" keys with your WiFi credentials. DO NOT share that file or commit it
into Git or other
# source control.
# pylint: disable=no-name-in-module,wrong-import-order
try:
    from secrets import secrets
except ImportError:
    print("WiFi secrets are kept in secrets.py, please add them there!")
    raise

# If you are using a board with pre-defined ESP32 Pins:
esp32_cs = DigitalInOut(board.ESP_CS)
esp32_ready = DigitalInOut(board.ESP_BUSY)
esp32_reset = DigitalInOut(board.ESP_RESET)

# If you have an externally connected ESP32:
# esp32_cs = DigitalInOut(board.D9)
# esp32_ready = DigitalInOut(board.D10)
# esp32_reset = DigitalInOut(board.D5)

spi = busio.SPI(board.SCK, board.MOSI, board.MISO)
esp = adafruit_esp32spi.ESP_SPIcontrol(spi, esp32_cs, esp32_ready, esp32_reset)

print("Connecting to AP...")
while not esp.is_connected:
    try:
        esp.connect_AP(secrets["ssid"], secrets["password"])
    except RuntimeError as e:
        print("could not connect to AP, retrying: ", e)
        continue
print("Connected to", str(esp.ssid, "utf-8"), "\tRSSI:", esp.rssi)

```



```

# Initialize a requests object with a socket and esp32spi interface
socket.set_interface(esp)
requests.set_socket(socket, esp)

JSON_GET_URL = "http://httpbin.org/get"

# Define a custom header as a dict.
headers = {"user-agent": "blinka/1.0.0"}

print("Fetching JSON data from %s..." % JSON_GET_URL)
response = requests.get(JSON_GET_URL, headers=headers)
print("-" * 60)

json_data = response.json()
headers = json_data["headers"]
print("Response's Custom User-Agent Header: {0}".format(headers["User-Agent"]))
print("-" * 60)

# Read Response's HTTP status code
print("Response HTTP Status Code: ", response.status_code)
print("-" * 60)

# Close, delete and collect the response data
response.close()

```

WiFi Manager

That simplest example works but its a little finicky - you need to constantly check WiFi status and have many loops to manage connections and disconnections. For more advanced uses, we recommend using the WiFiManager object. It will wrap the connection/status/requests loop for you - reconnecting if WiFi drops, resetting the ESP32 if it gets into a bad state, etc.

Here's a more advanced example that shows the WiFi manager and also how to POST data with some extra headers:

```

# SPDX-FileCopyrightText: 2019 ladyada for Adafruit Industries
# SPDX-License-Identifier: MIT

import time
import board
import busio
from digitalio import DigitalInOut
import neopixel
from adafruit_esp32spi import adafruit_esp32spi
from adafruit_esp32spi import adafruit_esp32spi_wifimanager

print("ESP32 SPI webclient test")

# Get wifi details and more from a secrets.py file
try:
    from secrets import secrets
except ImportError:
    print("WiFi secrets are kept in secrets.py, please add them there!")
    raise

# If you are using a board with pre-defined ESP32 Pins:
esp32_cs = DigitalInOut(board.ESP_CS)

```

```

esp32_ready = DigitalInOut(board.ESP_BUSY)
esp32_reset = DigitalInOut(board.ESP_RESET)

# If you have an externally connected ESP32:
# esp32_cs = DigitalInOut(board.D9)
# esp32_ready = DigitalInOut(board.D10)
# esp32_reset = DigitalInOut(board.D5)

spi = busio.SPI(board.SCK, board.MOSI, board.MISO)
esp = adafruit_esp32spi.ESP_SPIcontrol(spi, esp32_cs, esp32_ready, esp32_reset)
"""Use below for Most Boards"""
status_light = neopixel.NeoPixel(
    board.NEOPIXEL, 1, brightness=0.2
) # Uncomment for Most Boards
"""Uncomment below for ItsyBitsy M4"""
# status_light = dotstar.DotStar(board.APA102_SCK, board.APA102_MOSI, 1,
brightness=0.2)
# Uncomment below for an externally defined RGB LED
# import adafruit_rgbled
# from adafruit_esp32spi import PWMOut
# RED_LED = PWMOut.PWMOut(esp, 26)
# GREEN_LED = PWMOut.PWMOut(esp, 27)
# BLUE_LED = PWMOut.PWMOut(esp, 25)
# status_light = adafruit_rgbled.RGBLED(RED_LED, BLUE_LED, GREEN_LED)
wifi = adafruit_esp32spi_wifimanager.ESPSPI_WiFiManager(esp, secrets, status_light)

counter = 0

while True:
    try:
        print("Posting data...", end="")
        data = counter
        feed = "test"
        payload = {"value": data}
        response = wifi.post(
            "https://io.adafruit.com/api/v2/"
            + secrets["aio_username"]
            + "/feeds/"
            + feed
            + "/data",
            json=payload,
            headers={"X-AIO-KEY": secrets["aio_key"]},
        )
        print(response.json())
        response.close()
        counter = counter + 1
        print("OK")
    except OSError as e:
        print("Failed to get data, retrying\n", e)
        wifi.reset()
        continue
    response = None
    time.sleep(15)

```

You'll note here we use a secrets.py file to manage our SSID info. The wifimanager is given the ESP32 object, secrets and a neopixel for status indication.

Note, you'll need to add a some additional information to your secrets file so that the code can query the Adafruit IO API:

- aio_username
- aio_key

You can go to your adafruit.io View AIO Key link to get those two values and add them to the secrets file, which will now look something like this:

```
# This file is where you keep secret settings, passwords, and tokens!  
# If you put them in the code you risk committing that info or sharing it  
  
secrets = {  
    'ssid' : '_your_ssid_',  
    'password' : '_your_wifi_password_',  
    'timezone' : "America/Los_Angeles", # http://worldtimeapi.org/timezones  
    'aio_username' : '_your_aio_username_',  
    'aio_key' : '_your_aio_key_',  
}
```

Next, set up an Adafruit IO feed named **test**

- If you do not know how to set up a feed, [follow this page and come back when you've set up a feed named **test** . \(\)](#)

We can then have a simple loop for posting data to Adafruit IO without having to deal with connecting or initializing the hardware!

Take a look at your test feed on Adafruit.io and you'll see the value increase each time the CircuitPython board posts data to it!

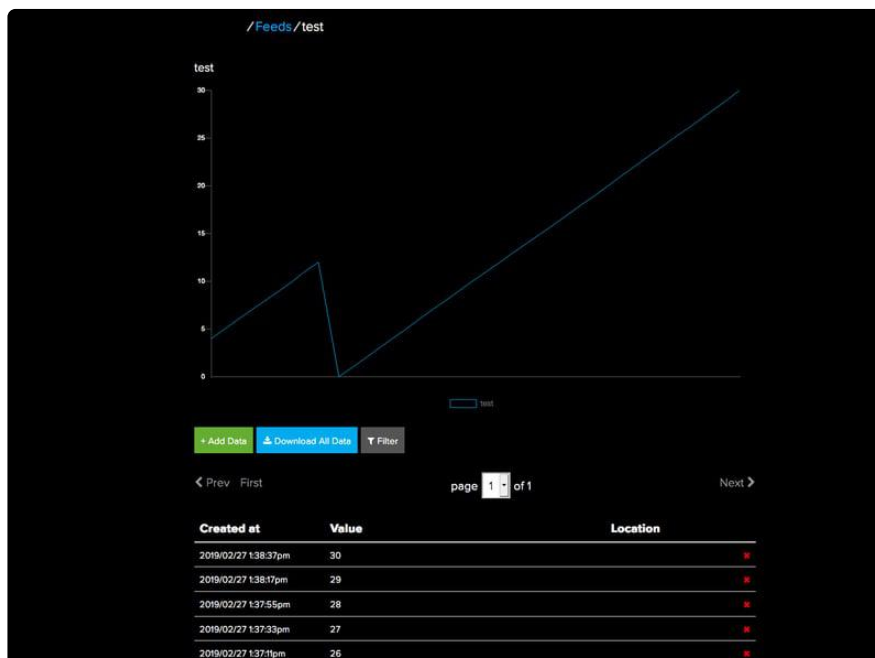

CircuitPython BLE

CircuitPython BLE UART Example

It's easy to use Adafruit AirLift ESP32 co-processor boards for Bluetooth Low Energy (BLE) with CircuitPython. When you reset the ESP32, you can put it in WiFi mode (the default), or in BLE mode; you cannot use both modes simultaneously.

Here's a simple example of using BLE to connect CircuitPython with the Bluefruit Connect app. Use CircuitPython 6.0.0 or later.

Note: Don't confuse the ESP32 with the ESP32-S2, which is a different module with a similar name. The ESP32-S2 does not support BLE.

Currently the AirLift support for CircuitPython only provides BLE peripheral support. BLE central is under development. So you cannot connect to BLE devices like Heart Rate monitors, etc., but you can act as a BLE peripheral yourself.

Adafruit AirLift ESP32 Breakout Wiring

If you have an Adafruit AirLift ESP32 Breakout board, you'll need to wire it to your microcontroller board. The following example shows it wired to a Feather M4. You can choose different pins for GPIO0, BUSY, and !RST, but the pin choices below correspond to several other boards, for consistency. If you do change the pins, keeping the TX and RX pins the same is a good idea. If you choose different pins, you'll need to edit the example program below.

Update the AirLift Firmware

You will need to update the AirLift's firmware to at least version 1.7.1. Previous versions of the AirLift firmware do not support BLE.

Follow the instructions in the guide below, and come back to this page when you've upgraded the AirLift's firmware:

Upgrade External ESP32 AirLift Firmware

Ensure the AirLift firmware is version 1.7.1 or higher for BLE to work.

Install CircuitPython Libraries

Make sure you are running the [latest version of Adafruit CircuitPython \(\)](#) for your board; you'll need 6.0.0 or later.

Next you'll need to install the necessary libraries to use the hardware and BLE. Carefully follow the steps to find and install these libraries from [Adafruit's CircuitPython library bundle \(\)](#). Our CircuitPython starter guide has [a great page on how to use the library bundle \(\)](#).

Install these libraries from the bundle:

- adafruit_airlift
- adafruit_ble

Before continuing make sure your board's lib folder or root filesystem has the adafruit_airlift and adafruit_ble folders copied over.

Install the Adafruit Bluefruit LE Connect App

The Adafruit Bluefruit LE Connect iOS and Android apps allow you to connect to BLE peripherals that provide a over-the-air "UART" service. Follow the instructions in the [Bluefruit LE Connect Guide \(\)](#) to download and install the app on your phone or tablet.

Copy and Adjust the Example Program

Copy the program below to the file code.py on CIRCUITPY on your board.

TAKE NOTE: Adjust the program as needed to suit the AirLift board you have. Comment and uncomment lines 12-39 below as necessary.

```
import board
```

```

from adafruit_ble import BLERadio
from adafruit_ble.advertising.standard import ProvideServicesAdvertisement
from adafruit_ble.services.nordic import UARTService

from adafruit_airlift.esp32 import ESP32

# If you are using a Metro M4 Airlift Lite, PyPortal,
# or MatrixPortal, you can use the default pin settings.
# Leave this DEFAULT line uncommented.
esp32 = ESP32() # DEFAULT

# If you are using CircuitPython 6.0.0 or earlier,
# on PyPortal and PyPortal Titano only, use the pin settings
# below. Comment out the DEFAULT line above and uncomment
# the line below. For CircuitPython 6.1.0, the pin names
# have changed for these boards, and the DEFAULT line
# above is correct.
# esp32 = ESP32(tx=board.TX, rx=board.RX)

# If you are using an AirLift FeatherWing or AirLift Bitsy Add-On,
# use the pin settings below. Comment out the DEFAULT line above
# and uncomment the lines below.
# If you are using an AirLift Breakout, check that these
# choices match the wiring to your microcontroller board,
# or change them as appropriate.
# esp32 = ESP32(
#     reset=board.D12,
#     gpio0=board.D10,
#     busy=board.D11,
#     chip_select=board.D13,
#     tx=board.TX,
#     rx=board.RX,
# )

# If you are using an AirLift Shield,
# use the pin settings below. Comment out the DEFAULT line above
# and uncomment the lines below.
# esp32 = ESP32(
#     reset=board.D5,
#     gpio0=board.D6,
#     busy=board.D7,
#     chip_select=board.D10,
#     tx=board.TX,
#     rx=board.RX,
# )

adapter = esp32.start_bluetooth()

ble = BLERadio(adapter)
uart = UARTService()
advertisement = ProvideServicesAdvertisement(uart)

while True:
    ble.start_advertising(advertisement)
    print("waiting to connect")
    while not ble.connected:
        pass
    print("connected: trying to read input")
    while ble.connected:
        # Returns b'' if nothing was read.
        one_byte = uart.read(1)
        if one_byte:
            print(one_byte)
            uart.write(one_byte)

```

Talk to the AirLift via the Bluefruit LE Connect App

Start the Bluefruit LE Connect App on your phone or tablet. You should see a CIRCUITPY device available to connect to. Tap the Connect button (1):

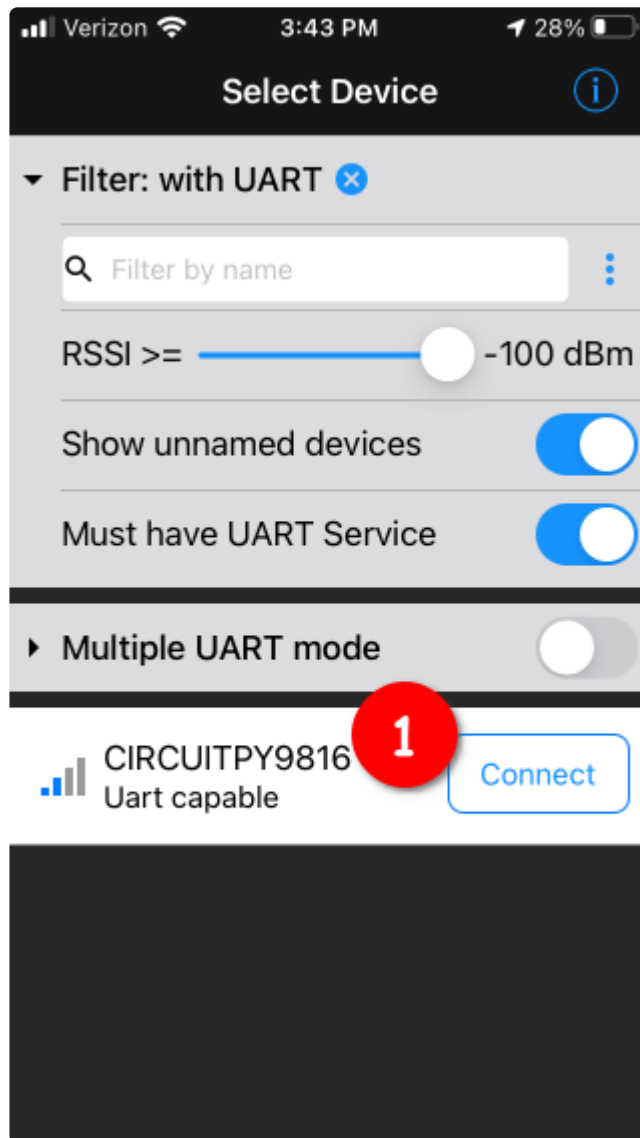

You'll then see a list of Bluefruit Connect functions ("modules"). Choose the UART module (2):

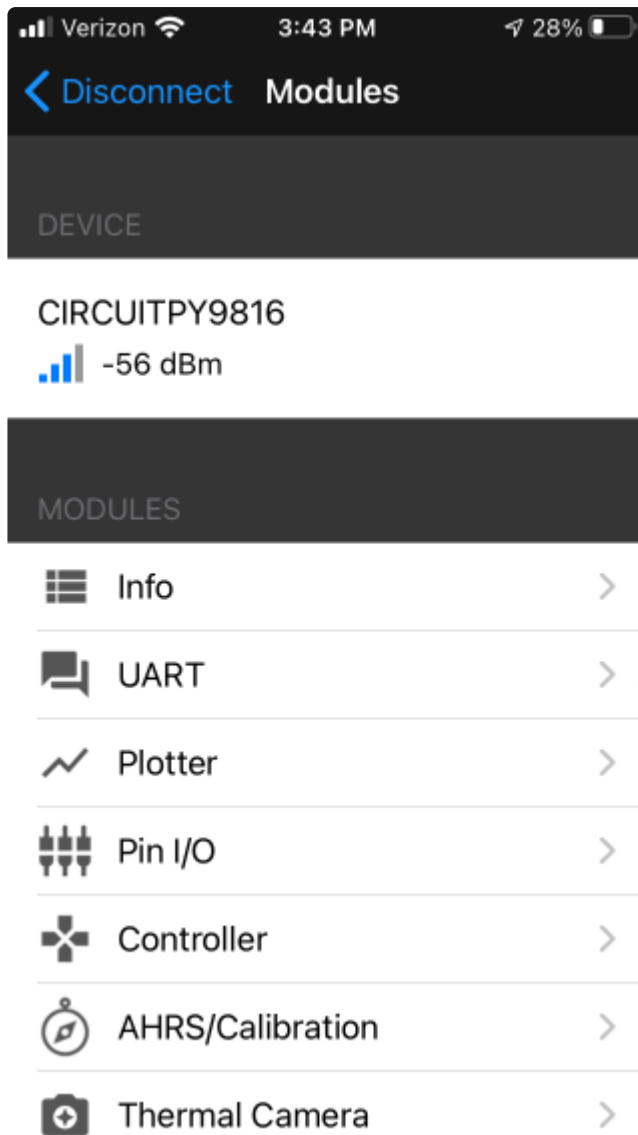

On the UART module page, you can type a string and press Send (3). You'll see that string entered, and then see it echoed back (echoing is in gray).



Arduino WiFi

You can use the AirLift with Arduino. Unlike CircuitPython, it work work with just about any Arduino chip, even a classic Arduino UNO. However, if you want to use libraries like ArduinoJSON or add sensors and SD card, you'll really want an ATSAMD21 (Cortex M0) or ATSAMD51 (Cortex M4), both of which have plenty of RAM.

Arduino Wiring

We'll show wiring to the hardware SPI pins, since the library does not support software SPI at all. You will need female-to-male header wires to get to these pins

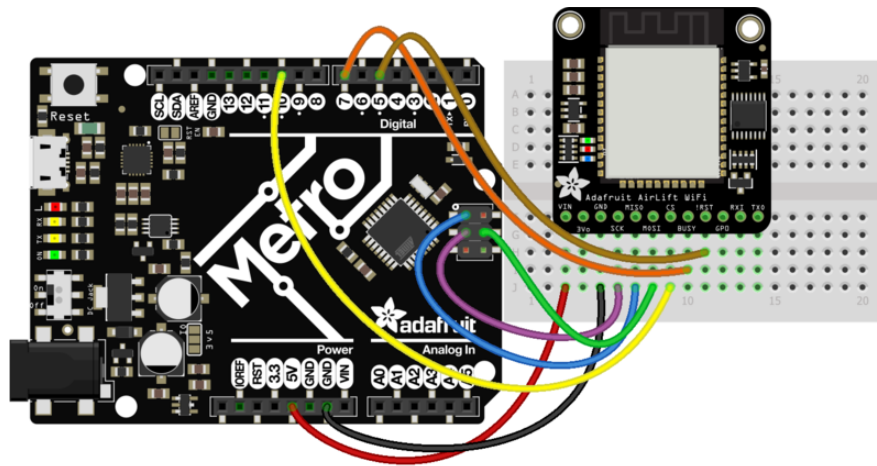

fritzing

Connect:

- AirLift VIN to 5V power (even if you are on a 3V microcontroller, you'll need the current available from the 5V power pin)
- AirLift GND to GND
- AirLift SCK to the 6-pin SPI header SPI SCK
- AirLift MOSI to the 6-pin SPI header SPI MOSI
- AirLift MISO to the 6-pin SPI header SPI MISO
- AirLift CS to digital 10 (you can change this later)
- AirLift Busy to digital 7 (you can change this later)
- AirLift Reset to digital 5 (you can change this later)

Library Install

We're using a variant of the Arduino Wi-FiNINA library, which is amazing and written by the Arduino team! The official WiFi101 library won't work because it doesn't support the ability to change the pins.

So! We made a fork that you can install.

Click here to download the library:

Download Adafruit's version of
Wi-FiNINA

Within the Arduino IDE, select Install library from ZIP...

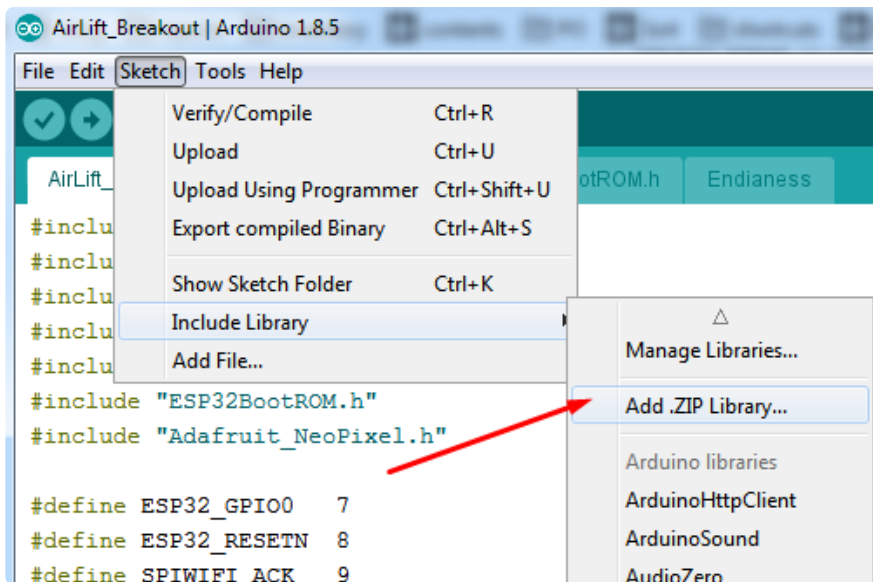

And select the zip you just downloaded.

First Test

OK now you have it wired and library installed, time to test it out!

Lets start by scanning the local networks. Load up the ScanNetworks example

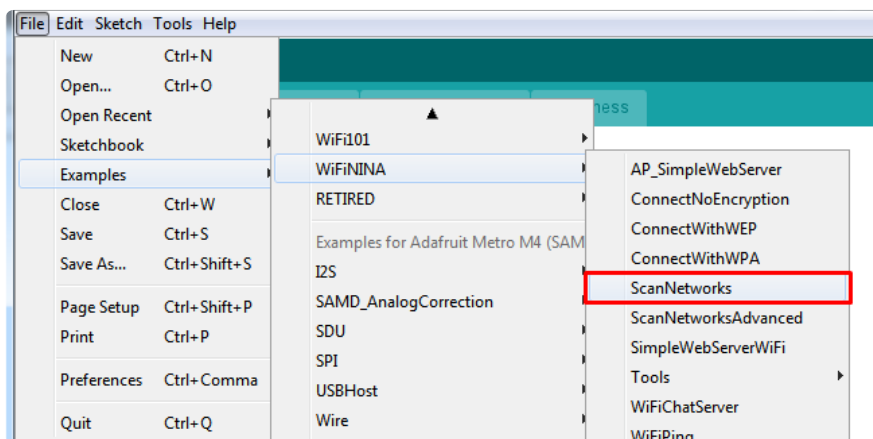

At the top you'll see a section where the GPIO pins are defined

```
// Configure the pins used for the ESP32 connection
#define SPIWIFI      SPI    // The SPI port
#define SPIWIFI_SS   10    // Chip select pin
#define SPIWIFI_ACK   7     // a.k.a BUSY or READY pin
#define ESP32_RESETN 5     // Reset pin
#define ESP32_GPIO0  -1    // Not connected
```

If you don't see this, you may have the wrong WiFiNINA library installed. Uninstall it and re-install the Adafruit one as above.

Compile and upload to your board wired up to the AirLift

```
WiFi Scanning test
MAC: C4:4F:33:0E:B0:BD
Scanning available networks...
** Scan Networks **
number of available networks:10
0) Adafruit      Signal: -56 dBm Encryption: WPA2
1) Consulate Guest  Signal: -59 dBm Encryption: WPA2
2) consulatewireless  Signal: -60 dBm Encryption: WPA2
3) Adafruit      Signal: -66 dBm Encryption: WPA2
4) consulatewireless  Signal: -67 dBm Encryption: WPA2
5) Consulate Guest  Signal: -69 dBm Encryption: WPA2
6) Adafruit      Signal: -69 dBm Encryption: WPA2
7) Consulate Guest  Signal: -71 dBm Encryption: WPA2
8) consulatewireless  Signal: -72 dBm Encryption: WPA2
9) ESP_88EF6C     Signal: -75 dBm Encryption: None
```

If you don't even get the MAC address printed out, check your wiring.

If you get the MAC address but cannot scan any networks, check your power supply. You need a solid 3-5VDC into Vin in order for the ESP32 not to brown out.

WiFi Connection Test

Now that you have your wiring checked, time to connect to the Internet!

Open up the WiFiWebClient example

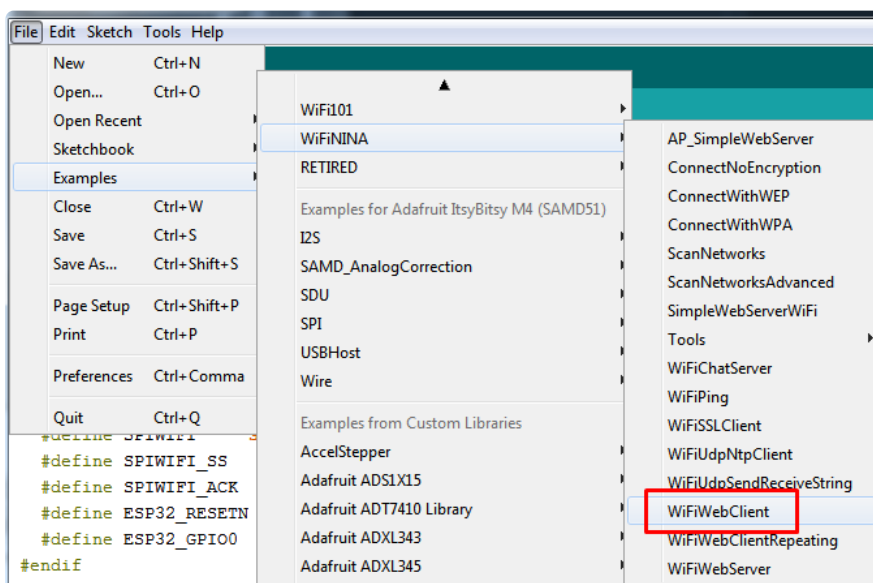

Open up the secondary tab, `arduino_secrets.h`. This is where you will store private data like the SSID/password to your network.

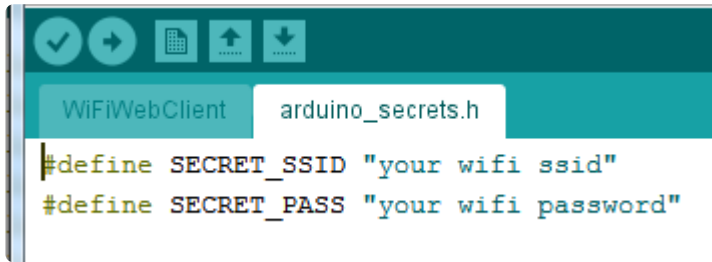

```
WiFiWebClient  arduino_secrets.h
#define SECRET_SSID "your wifi ssid"
#define SECRET_PASS "your wifi password"
```

You must change these string values before updating to your board!

After you've set it correctly, upload and check the serial monitor. You should see the following. If not, go back, check wiring, power and your SSID/password

```
Found firmware 1.3.0
Attempting to connect to SSID: Adafruit
Connected to wifi
SSID: Adafruit
IP Address: 10.0.1.179
signal strength (RSSI):-44 dBm

Starting connection to server...
connected to server
HTTP/1.1 200 OK
Server: nginx/1.10.3 (Ubuntu)
Date: Wed, 10 Apr 2019 20:55:51 GMT
Content-Type: text/html
Content-Length: 73
Last-Modified: Thu, 16 Feb 2017 17:42:29 GMT
Connection: close
ETag: "58a5e485-49"
Accept-Ranges: bytes

This is a test of the CC3000 module!
If you can read this, its working :)
disconnecting from server.
```

Secure Connection Example

Many servers today do not allow non-SSL connectivity. Lucky for you the ESP32 has a great TLS/SSL stack so you can have that all taken care of for you. Here's an example of a secure WiFi connection:

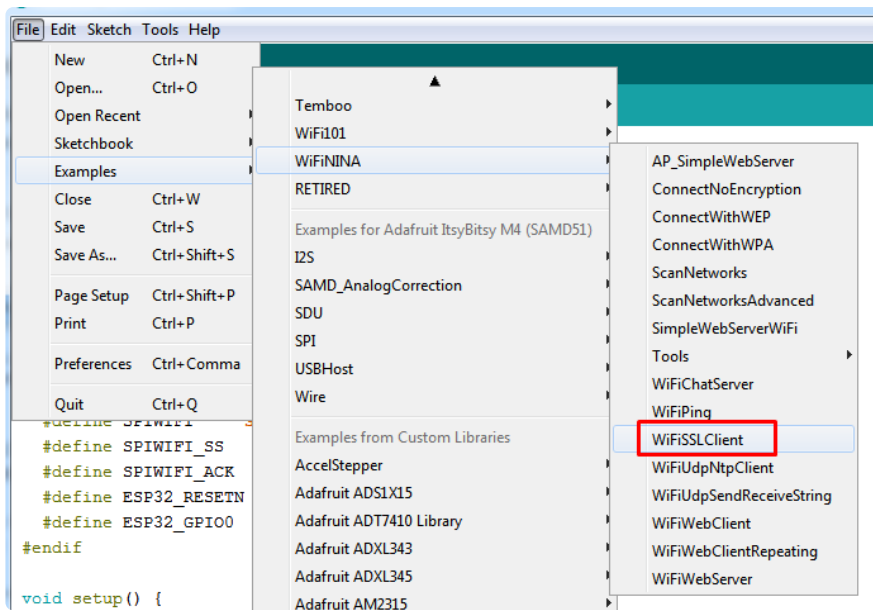

Note we use **WiFiSSLClient client**; instead of **WiFiClient client**; to require an SSL connection!

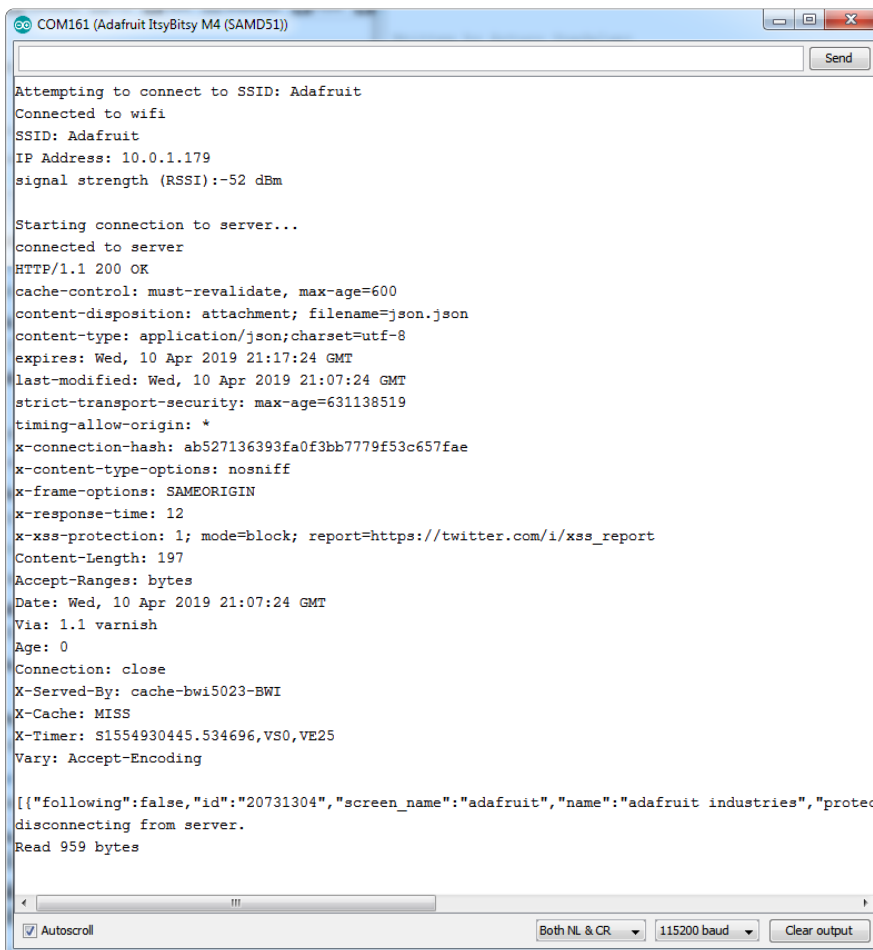

JSON Parsing Demo

This example is a little more advanced - many sites will have API's that give you JSON data. We'll use [ArduinoJSON \(\)](#) to convert that to a format we can use and then display that data on the serial port (which can then be re-directed to a display of some sort)

First up, [use the Library manager to install ArduinoJSON \(\)](#).

Then load the example JSONdemo

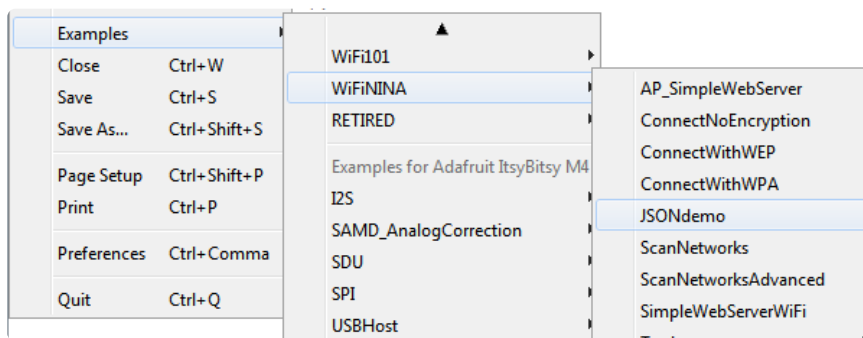

By default it will connect to to the Twitter banner image API, parse the username and followers and display them.

```
Attempting to connect to SSID: Adafruit
Connected to wifi
SSID: Adafruit
IP Address: 10.0.1.179
signal strength (RSSI):-51 dBm

Starting connection to server...
connected to server
Response:
Twitter username: adafruit
Twitter followers: 159265
```

Adapting Other Examples

Once you've got it connecting to the Internet you can check out the other examples. The only change you'll want to make is at the top of the sketches, add:

```
// Configure the pins used for the ESP32 connection
#if !defined(SPIWIFI_SS) // if the wifi definition isnt in the board variant
// Don't change the names of these #define's! they match the variant ones
```

```

#define SPIWIFI      SPI
#define SPIWIFI_SS   10 // Chip select pin
#define SPIWIFI_ACK   7 // a.k.a BUSY or READY pin
#define ESP32_RESETN 5 // Reset pin
#define ESP32_GPI00  -1 // Not connected
#endif

```

And then before you check the `status()` of the module, call the function `WiFi.setPins(SPIWIFI_SS, SPIWIFI_ACK, ESP32_RESETN, ESP32_GPI00, &SPIWIFI);`

```

// check for the WiFi module:
WiFi.setPins(SPIWIFI_SS, SPIWIFI_ACK, ESP32_RESETN, ESP32_GPI00, &SPIWIFI);
while (WiFi.status() == WL_NO_MODULE) {
  Serial.println("Communication with WiFi module failed!");
  // don't continue
  delay(1000);
}

```

Of course you can adjust the pins and SPI port if you like!

Downloads

Files

- [EagleCAD PCB Files on GitHub \(\)](#)
- [Fritzing Object in the Adafruit Fritzing Library \(\)](#)

Schematic

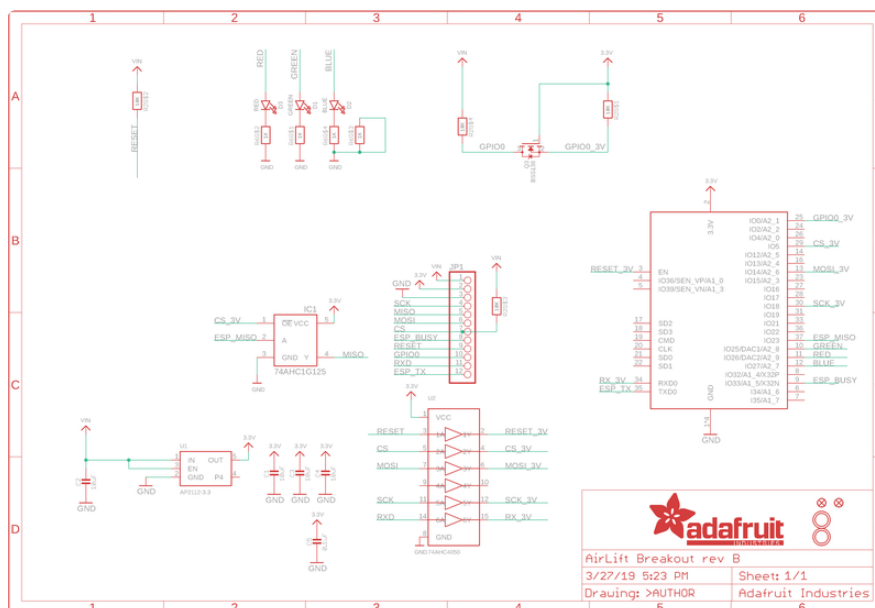

Fab Print

