



Figure similar

Electrically held lighting contactor, (convertible to mech. held), Amp rating 30A (tungsten 20A), 5 N.C. / 0 N.O. poles, 115-120V 60Hz/110V 50Hz coil, Non-combination type, Enclosure NEMA type (open), No enclosure

| | |
|---|---|
| product brand name | Class LC |
| design of the product | Electrically held lighting contactor (convertible to mechanically held) |
| special product feature | Electrically held convertible to mechanically held; Power poles convertible between NO and NC |
| General technical data | |
| weight [lb] | 3 lb |
| Height x Width x Depth [in] | 7.39 × 4.18 × 3.86 in |
| touch protection against electrical shock | Main circuit (finger-safe); Control circuit (finger-safe) |
| installation altitude [ft] at height above sea level maximum | 6560 ft |
| ambient temperature [°F] | |
| • during storage | -22 ... +149 °F |
| • during operation | -13 ... +104 °F |
| ambient temperature | |
| • during storage | -30 ... +65 °C |
| • during operation | -25 ... +40 °C |
| country of origin | USA |
| Contactors | |
| size of contactor | 30 Amp |
| number of NO contacts for main contacts | 0 |
| number of NC contacts for main contacts | 5 |
| operating voltage for main current circuit at AC at 60 Hz maximum | 600 V |
| Type of main contacts | Silver alloy, double break |
| mechanical service life (switching cycles) of the main contacts typical | 100000 |
| contact rating of the main contacts of lighting contactor | |
| • at tungsten (1 pole per 1 phase) rated value | 20A @277V 1p 1ph |
| • at tungsten (2 poles per 1 phase) rated value | 20A @480V 2p 1ph |
| • at tungsten (3 poles per 3 phases) rated value | 20A @480V 3p 3ph |
| • at ballast (1 pole per 1 phase) rated value | 30A @347V 1p 1ph |
| • at ballast (2 poles per 1 phase) rated value | 30A @600V 2p 1ph |
| • at ballast (3 poles per 3 phases) rated value | 30A @600V 3p 3ph |
| • at resistive load (1 pole per 1 phase) rated value | 30A @600V 1p 1ph |
| • at resistive load (2 poles per 1 phase) rated value | 30A @600V 2p 1ph |
| • at resistive load (3 poles per 3 phases) rated value | 30A @600V 3p 3ph |
| Auxiliary contact | |
| number of NC contacts for auxiliary contacts | 0 |
| number of NO contacts for auxiliary contacts | 0 |
| number of total auxiliary contacts maximum | 4 |

| | |
|---|-----------------------------------|
| contact rating of auxiliary contacts of contactor according to UL | NA |
| Coil | |
| type of voltage of the control supply voltage | AC |
| control supply voltage | |
| • at AC at 50 Hz rated value | 110 V |
| • at AC at 60 Hz rated value | 115 ... 120 V |
| apparent pick-up power of magnet coil at AC | 248 VA |
| apparent holding power of magnet coil at AC | 28 VA |
| operating range factor control supply voltage rated value of magnet coil | 0.85 ... 1.1 |
| Enclosure | |
| degree of protection NEMA rating of the enclosure | Open device (no enclosure) |
| design of the housing | NA |
| Mounting/wiring | |
| mounting position | Vertical |
| fastening method | Surface mounting and installation |
| type of electrical connection for supply voltage line-side | Screw-type terminals |
| tightening torque [lbf-in] for supply | 35 ... 35 lbf-in |
| type of connectable conductor cross-sections at line-side at AWG cables single or multi-stranded | 2x (14 ... 8 AWG) |
| temperature of the conductor for supply maximum permissible | 75 °C |
| material of the conductor for supply | CU |
| type of electrical connection for load-side outgoing feeder | Screw-type terminals |
| tightening torque [lbf-in] for load-side outgoing feeder | 35 ... 35 lbf-in |
| type of connectable conductor cross-sections at AWG cables for load-side outgoing feeder single or multi-stranded | 2x (14 ... 8 AWG) |
| temperature of the conductor for load-side outgoing feeder maximum permissible | 75 °C |
| material of the conductor for load-side outgoing feeder | CU |
| type of electrical connection of magnet coil | Screw-type terminals |
| tightening torque [lbf-in] at magnet coil | 15 ... 15 lbf-in |
| type of connectable conductor cross-sections of magnet coil at AWG cables single or multi-stranded | 2x (18 ... 14 AWG) |
| temperature of the conductor at magnet coil maximum permissible | 75 °C |
| material of the conductor at magnet coil | CU |
| Short-circuit current rating | |
| design of the fuse link for short-circuit protection of the main circuit required | 100kA@600V (Class R or J 40A max) |
| design of the short-circuit trip | Thermal magnetic circuit breaker |
| breaking capacity maximum short-circuit current (Icu) | |
| • at 240 V | 24 kA |
| • at 480 V | 65 kA |
| • at 600 V | 25 kA |
| certificate of suitability | NEMA ICS 2; UL 508 |

Further information

Industrial Controls - Product Overview (Catalogs, Brochures,...)

www.usa.siemens.com/iccatalog

Industry Mall (Online ordering system)

<https://mall.industry.siemens.com/mall/en/us/Catalog/product?mifb=US2:LCE00C500120A>

Service&Support (Manuals, Certificates, Characteristics, FAQs,...)

<https://support.industry.siemens.com/cs/US/en/ps/US2:LCE00C500120A>

Image database (product images, 2D dimension drawings, 3D models, device circuit diagrams, EPLAN macros, ...)

http://www.automation.siemens.com/bilddb/cax_de.aspx?mifb=US2:LCE00C500120A&lang=en

Certificates/approvals

<https://support.industry.siemens.com/cs/US/en/ps/US2:LCE00C500120A/certificate>

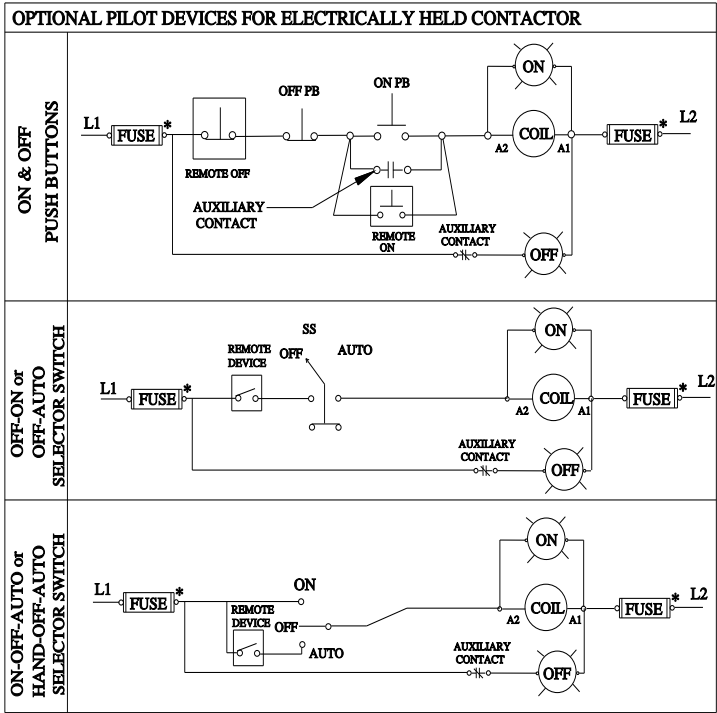

* -- IF USED

D38297001

last modified:

1/6/2022