

Operating manual

MODEL 105 TUNNEL OVEN (TE 1-1198896-5
RAYCHEM 955018-000)

Customer Manual No. 412-94301
Customer Manual PN: 9-744015-9
Language: en (original)

The Model 105 Tunnel Oven is manufactured for TE Connectivity

- All of the information in this manual, including illustrations, is believed to be reliable. Users, however, should independently evaluate the suitability of each product for their application.
- TE makes no warranties as to the accuracy or completeness of the information and disclaims any liability regarding its use.
- TE's only obligations are those in the Standard Terms and Conditions of Sale for this product and in no case will TE be liable for any incidental, indirect or consequential damages arising from the sale, resale, use or misuse of the product.
- TE Specifications are subject to change without notice. In addition TE reserves the right to make changes in materials or processing, without notification to the Buyer, which do not affect compliance with any applicable specification.

Table of contents

1	DESCRIPTION	3
1.1	General	3
1.2	Introduction	4
1.3	Left-Right Conventions	5
1.4	Safety Features/Self Diagnostic Circuitry	5
1.5	Components and Controls	9
1.6	Control Enclosure Layout	11
1.7	Specifications	13
2	PREVENTING EQUIPMENT DAMAGE.....	14
3	SETUP	15
3.1	Unpacking, Transport, Handling and Storage	15
3.2	Top Assembly Adjustment.....	15
3.3	Removing Shipping Support.....	17
3.4	Inspection (Power Off).....	17
3.5	Electrical Connections	17
3.6	Inspection (Power On).....	18
4	Operation	19
4.1	Power On and Warm-up.....	20
4.2	Loading and Unloading	20
4.3	Power OFF and Cool-Down	20
5	MAINTENANCE.....	21
5.1	Daily Maintenance	21
5.2	Semi-Annual Maintenance	22
5.2.1	Clean the inside of the Tunnel Oven	22
5.2.2	Change temperature setpoint to 0°C.....	22
5.2.3	General condition check.....	22
5.2.4	Check the Conveyor Belt for tension.....	22
5.2.5	Inspect the motor brushes.....	22
5.2.6	Lubricate Drive Chain.....	22
5.3	Maintenance Procedures	22
5.3.1	Belt Tension Adjustment	22
5.3.2	Upper Heater Element Replacement	24
5.3.3	Lower Heater Element Replacement	24
6	TROUBLESHOOTING.....	25
6.1	Troubleshooting Guide	25
6.1.1	Troubleshooting Guide (continued)	26

6.2	Heater Element Test	26
6.3	Thermocouple Check	27
6.4	Cool Down circuit test.....	27
6.5	Solid State Relay/Temperature Controller Test	28
6.6	Over Temperature Switch Test	28
6.7	Drive Circuit Test.....	29
6.7.1	Motor Controller.....	29
6.7.2	Motor Resistance.....	29
6.7.3	Motor Brush Inspection	29
7	CALIBRATION AND ADJUSTMENTS.....	30
7.1	Motor Controller / Speed Calibration	30
7.2	Temperature Controller	31
7.2.1	Changing Temperature Set Point.....	31
7.2.2	Parameter Settings and Temperature Controller Operation	31
8	SPARE PARTS LIST	36
9	ELECTRICAL SCHEMATIC	37
10	Customer Support.....	39

1 DESCRIPTION

1.1 General

The Model 105 Tunnel Oven is a low maintenance, high production heater that provides a controlled processing system, suitable for processing a variety of products, including heat-shrinkable tubing and thermal curing of various products. The unit is designed as a modular unit consisting of the upper heater chamber and base, modular wire mesh belt conveyor with lower heater element, and a remote electrical enclosure. The standard unit, P/N 12000012 is provided with a 39" long conveyor. The wire mesh belt conveyor is designed to permit custom conveyor lengths in excess of 39" for specific customer application requirements. A four foot detachable umbilical cable connects the processor unit to the control enclosure.

The Model 105 Tunnel Oven is a table top unit. Overall dimensions of the unit is approximately 27" W x 39" L x 16 ½" H. The two key process parameters of conveyor speed, and heater element temperature are controlled using closed loop electronic modules. Speed settings range from 0 to 5 feet/minute, and temperature settings range from ambient to 700°C, however settings below 0.5 feet per minute and above 600°C are not recommended. The Tunnel Oven is designed to run continuously at the recommended settings. The Model 105 Tunnel Oven has two upper housing height positions. The upper pivot position provides 4 inch nominal oven clearance for large part production. The lower position provides 2.25 inch nominal oven clearance for smaller parts.

An auxiliary E-Stop enclosure is provided on a flying lead, suitable for customer positioning when two operators are required for production processing.

The Model 105 Tunnel Oven also contains many self diagnostic and safety features to protect the operator, machine and product. These include alarms, indicator lights and cool down circuitry, when the OFF ("O") push button is pressed, the Tunnel Oven goes into a 20 minute Cool Down mode that allows the conveyor and fans to run without the heater elements. This prevents components in the machine from being repeatedly exposed to high temperatures when powered down.

These indicator lights and alarms include:

"Cool Down" - Power has been turned off and the machine is in cool down mode.

"Process Ready" - The oven temperature is in the preset temperature range for processing product.

"Over Temp" – the internal chamber temp exceeds the rating of a thermal switch.

"Heater Fault"-- one of the heating elements fails.



It is the user's responsibility to independently verify all process parameters and settings immediately after equipment is installed. The user must also maintain and adjust the equipment, monitor the process, and inspect the installed product to ensure that process requirements are met on an ongoing basis.

1.2 Introduction

Caution



This symbol (black print on yellow background) indicates that there is something that could damage the machine or cause bodily harm if not handled properly. Refer to the manual for further instructions.

Read Manual

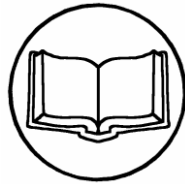

This symbol directs the operator to read the manual in order to understand the operation of the machine.

Hot Surface



This symbol (black print on yellow background) indicates that a given surface becomes hot during normal operation of the machine. Care must be to avoid direct skin contact with this surface.

High Voltage



This symbol (black print on yellow background) indicates that high voltage is present in the vicinity. Only trained technicians should be working in such an area. Normal procedures for working in such an area dictate that the machine be powered down, and the power be removed by unplugging the main power cord from the facility's power supply outlet. In circumstances where this is not possible, the technician must exercise extreme care to avoid contact between body parts, conductive tools, and electrical conductors.

Wear Protective Clothing



This symbol directs the operator to wear protective clothing when operating the machine. Most specifically cotton gloves and long sleeve cotton shirts which protect the operator from hot surfaces which may be encountered.

Use Protective Eye Wear



This symbol directs the operator to use protective eye wear when operating the machine.

Keep Hands Out of This Area of the Machine



This symbol directs the operator to keep their hands out of this area while operating the machine.

1.3 Left-Right Conventions

In this document, left and right are always defined with respect to the operator when standing in a normal working position. That is, standing in front of and facing the Tunnel Oven.

1.4 Safety Features/Self Diagnostic Circuitry

Cool Down Circuit

To prevent equipment damage, a timer circuit allows the fans and belt to continue running after the OFF ("O") button is pressed. This circuit will shut off power to the heater elements while allowing the conveyor and fans to run for a period of 20 minutes, at which time all power will shut off automatically. The Cool down Indicator illuminates when the Tunnel Oven is operating in this mode.

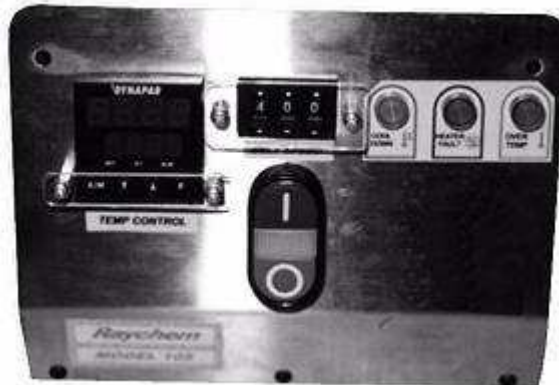

Front of Control Enclosure

Heater Fault Circuit

The Heater Fault Circuit constantly monitors the current flowing to the two heater elements during normal operation. In the event of a heater element failure (open circuit) the heater fault circuit senses a difference in current between the two elements, and sounds an audible alarm. The Heater Fault Indicator is also illuminated. If this condition occurs, the operator should press the OFF ("O") button and allow the unit to begin cooling. **The operator must not run product through the Tunnel Oven while this indicator is on.** After the Tunnel Oven has cooled down, an ohmmeter can be used to probe the end of the heater element plug and determine which heater element has failed. Once the problem has been corrected, normal operation may begin again.

Over Temperature Indicator

In the event of the heater element temperature becomes excessive, a light on the front of the Control Enclosure will illuminate. The machine will automatically enter Cool Down mode. See over Temperature Switch Below for more information.

Emergency Stop Enclosure

The Emergency Stop Enclosure is located on the front left hand side of the Tunnel Oven. Aside from the Emergency Stop Button, the enclosure contains a second Cool down Indicator a second Heater Fault Indicator as well and a Process Ready Indicator. If so desired by the user, an additional Emergency Stop station may be added to the unit. This can be done by purchasing an Auxiliary Emergency Stop Enclosure from TE. Simply remove the rear jumper plug from the factory installed Emergency Stop Enclosure, and plug the Auxiliary Emergency Stop Enclosure flying lead into the connector on the rear of the factory installed enclosure. The Auxiliary Emergency Stop Enclosure may be mounted where deemed necessary by the user.



Emergency Stop Enclosure

Processor Ready Indicator

When the heater element temperature falls within the allowable processing temperature limits, a light on the Emergency Stop Enclosure will illuminate. **The operator must not run product through the Tunnel Oven unless this indicator is on.** The factory setting for this indicator is $\pm 20^{\circ}\text{C}$ of the temperature set point. This value is set in the Band Alarm 2 location in the Temperature Controller.

Emergency Stop Button

There is an Emergency Stop button located on the upper heating chamber. Pressing this button will kill all power to the Tunnel Oven.



Note: Do not use the Emergency Stop Button for normal shut down as it will defeat the cool down circuit.

Circuit Breaker

All mains circuitry is protected from electrical overload by the Main Circuit Breaker (1CB) located on the rear of the Control Enclosure. It may be left on indefinitely and should be turned OFF only after the Tunnel Oven has completed its Cool Down mode.



Note: Do not use the Circuit Breaker for normal shut down as it defeats the cool down circuit.

Fuses

There are two (2) fuses protecting the Tunnel Oven control circuitry. These fuses are labeled 1 Fuse (1FU), and 2 Fuse (2FU) and are located on the rear of the Control Enclosure. Fuse 1FU protects the control transformer (1XFMR) and fuse 2FU protects all 120V control circuits including fans and control devices. These fuses are 5x20mm IEC low breaking time delay fuses. 1FU is a 1.6A fuse (Littelfuse #21801.6, Bussman #GDC-1.6A or equivalent) while 2FU is a 1A fuse (Littelfuse #218001, Bussman #GDC-1A or equivalent).

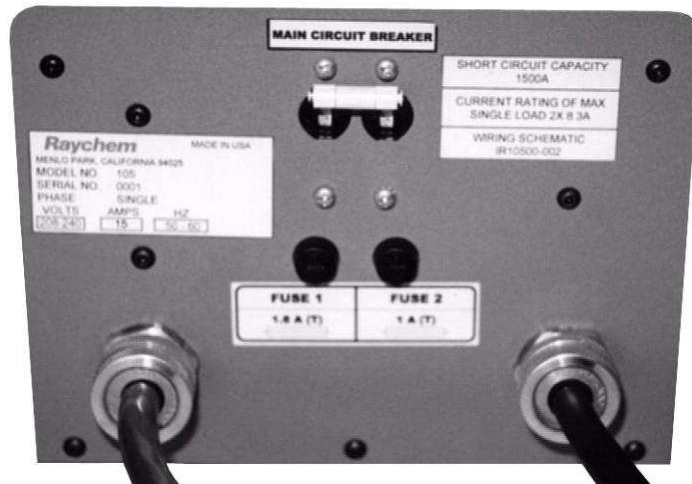

Rear of Control Enclosure

Top Lock Pin

The Top Lock Pin is used to lock the top of the Tunnel Oven in a full open (vertical) or partially open (30° from vertical) position for heater element change or other maintenance. To use the Top Lock Pin, open the Tunnel Oven Top with one hand by grasping the handle on the right side of the unit and hold it at the desired position. This will expose the Top Lock Pin in its holder. Retrieve the Top Lock Pin from its holder. (The pin is tethered to the Tunnel Oven by a chain.) While still supporting the top with one hand, fully insert the Top Lock Pin into the hole or channel in the Pivot Stand, making sure that the pin also passes through the hole in the Pivot Block. When fully inserted the top will be locked in position. Work on the Tunnel Oven can then proceed safely. When work is complete, support the top with one hand and remove the pin with the other, and reverse the process described above to place the Tunnel Oven into its normal operating state. When returning the pin to its holder, make sure the chain is hanging in the cavity between the holder mounting angle and the electrical control enclosure.



Top Lock Pin – Engaged

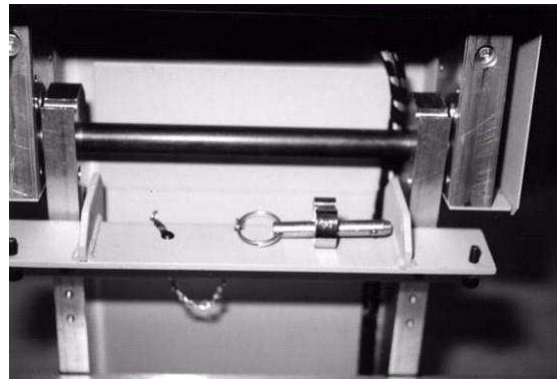

Top Lock Pin - Stored

Note: Always use the Top Lock Pin to secure the hinged conveyor top when it is not in the horizontal position. Failure to do so can result in serious personal injury and/or damage to the unit.

Before operating the unit, the top must be returned to its horizontal position. To do this, support the Tunnel Oven Top with one hand by grasping the handle. Remove the Top Lock Pin from the Pivot Stand with the other hand and return it to its holder. Gently lower the top until it engages the Top Rest Pins.

1.5 Components and Controls

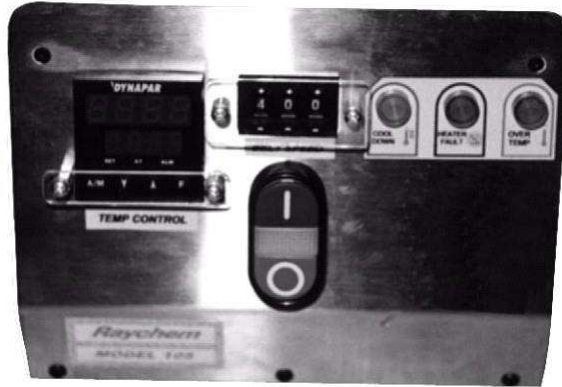

Front of Control Enclosure

ON ("I") Push Button

This button is used to turn the machine on at the beginning a shift, or to restore power to the heater elements during the Cool Down mode. It is located on the front of the Control Enclosure.

OFF ("O") Push Button

This button is used to turn off the Tunnel Oven. Pressing this button puts the Tunnel Oven in the cool down mode, shutting off power to the heater elements and illuminating the Cool down Indicator. This button is also used to clear the Heater Fault Circuitry, turning off the indicator light and silencing the Audible Alarm once it has been activated. After the OFF ("O") button is pressed, the conveyor and fans to continue to operate for 20 minutes, allowing the Tunnel Oven cool to a safe temperature. At the end of this Cool Down period, the conveyor and fans will shut OFF automatically. The OFF ("O") push button is located on the front of the Control Enclosure.

"On" Indicator

This Tunnel Oven "On" indicator is located between the ON ("I") and OFF ("O") push buttons. When illuminated, it indicates that the Tunnel Oven is in normal operating mode with power applied to the heater elements. If it is not illuminated, the Tunnel Oven is completely shut down, or in Cool Down mode, which means there is no power applied to the heater elements.

Temperature Controller

The temperature controller uses type K thermocouple (integral to the Upper Heater Element) to close the temperature loop. The heater element temperature set point may be adjusted from 0 to 600°C for different types and sizes of assemblies and tubing. UP and Down arrows on the face of the controller adjust the temperature set point. The Temperature Controller is located on the front of the Control Enclosure.

Oven Top Assembly

The Oven Top Assembly can be set to two (2) different positions. The upper position provides a 4 inch vertical opening for taller parts. The lower position provides a 2 ¼ inch vertical opening. The lower setting is recommended if the height of parts to be run through the machine do not exceed 2 ¼ inches.

Top Cover/Air Vents

There are air vents located on the oven Top Cover of the Tunnel Oven. When reinstalling this cover make sure the vent openings face away from the top lift handle. (Venting toward the left side of the Tunnel Oven). Failure to do so may cause over heating of critical electrical components in the top of the Tunnel Oven.

Front and Rear Heat Shields

Heat Shields are located on the front and rear of the oven Top Cover. These covers are to be adjusted to the lowest possible position that still provides clearance for parts to enter the oven chamber. This will ensure optimum efficiency and consistent performance.

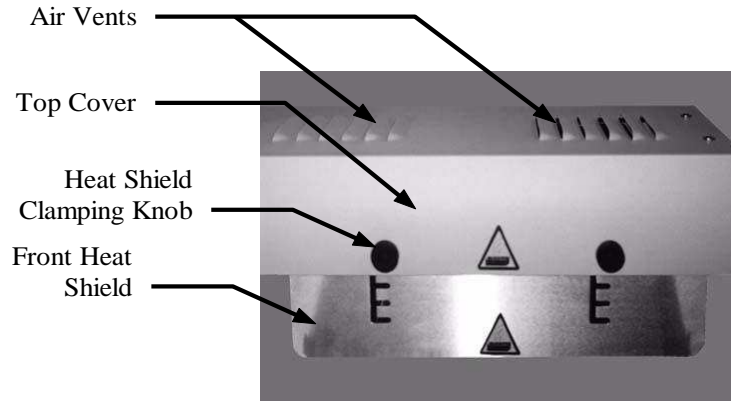

Oven Top Assembly

Heater Elements

Two (2) infra-red heater elements, one upper and one lower are used in the Tunnel Oven. Each element is rated 1500 Watts at 240 Volts, and may be used at nominal mains voltages ranging from 208 to 240 Volt 50/60 Hz AC. The upper heater element contains an integral "K" type thermocouple.

Over Temperature Switch

An Over Temperature Switch Located on top of the upper Heater Element Enclosure protects the machine from Over Temperature conditions resulting from faulty control components or shorted thermocouple wiring. When an excessive temperature is sensed, the switch trips, the Over Temperature Indicator on the front of the Control Enclosure will illuminate. The machine will automatically enter Cool Down mode.

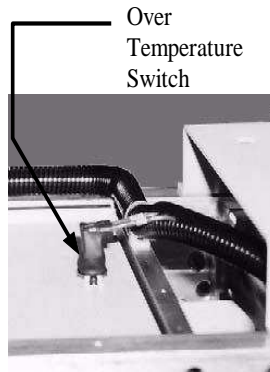

Drive Chain

The drive chain is located between the motor and the rear conveyor shaft. It should be lubricated with a commercially available chain lubricant every six months.

Note: Drive chain may cause personal injury or product damage if fingers, clothing, or product enters into drive chain/sprocket area. Never operate machine without chain guard and left rear belt guard in place.

Conveyor Shaft Bearings

The rear conveyor shaft is mounted into permanently lubricated bearing units. The front roller rides on permanently lubricated roller bearings as well. The front roller can be loosened and moved using a 13 mm open end wrench to adjust conveyor belt tension if required (see section 5.3.1). Spacer clips on the front roller bearing assemblies must be removed before the wrench can be inserted on the clamping bolt. Always replace spacer clips after tightening clamping bolts. No lubrication of the bearing units is required over the life of the Tunnel Oven.

Conveyor Belt

The conveyor belt is made out of stainless steel and needs no lubrication during its service life. If required, the belt may be taken apart by cutting the splice link that holds it together. Animated instructions on installing and removing splice clips can be found on the Internet at URL <http://www.wirebelt.com>. This is a low tension belt and should not be over tightened. Generally the belt needs to be only tight enough to present slipping on the drive belt cogs. Replacement belts and splice clips may be purchased from TE.

Note: Conveyor belt may cause personal injury or product damage if fingers, clothing, or product gets entangled in belt slots or pinched between moving and stationary components. Exercise caution when operating the machine. Never operate machine without all belt guards in place. There are seven (7) belt guards on the machine. They are the front side, center side, and rear side guards (both left and right sides), and the front belt guard.

1.6 Control Enclosure Layout

The Control Enclosure (shown at right) houses the bulk of the electrical and electronic components. All items are identified by schematic designation. The below table defines the each of the mentioned items.

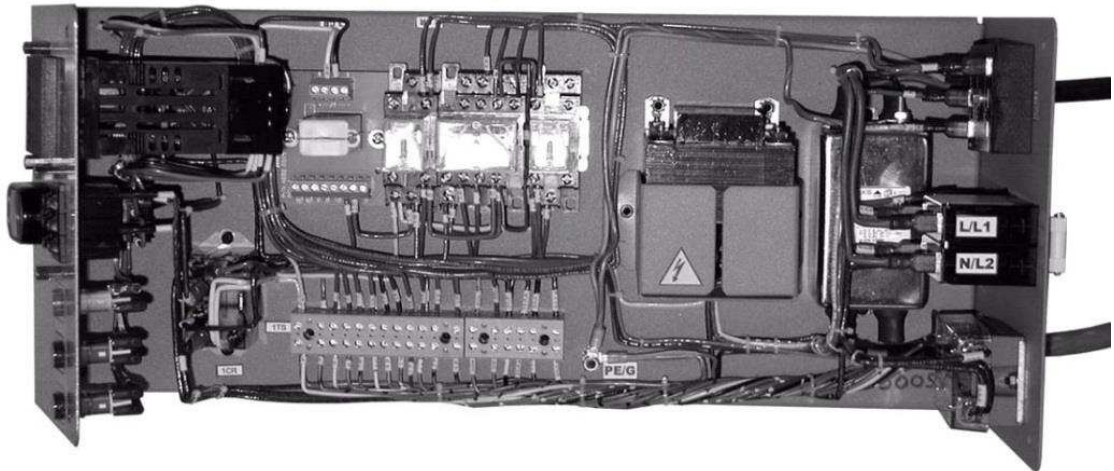

Electrical Enclosure Components

Designator	Description
1CB	Circuit Breaker, 2 Pole, 15A, 250VAC, 50/60 Hz, UL, CSA, VDE Approved
2PB	Contact Block, 22.5mm IEC, 3 Across, NC
3PB	Contact Block, 22.5mm IEC, 3 Across, NO
2,3PB,1LT	Dual Push Button w/ 125 VAC Pilot Light, Red "O" Button, Green "I" Button, 1NO Contact on "I" Button, 1NC Contact on "O" Button
1FLT	Line Filter, 120/250 VAC, 20A, 50/60 Hz
1XFMR	Transformer, 130 VA - 115/230 V Input, 115/230 V Output, 50/60 Hz, VDE Approved
CRM	Relay, 4PDT, 10A, 220VAC Contacts, 120 VAC 50/60Hz Coil, VDE Approved
CRM	Relay Socket, 4PDT, 10A, 220VAC, Surface or DIN Rail Mount
CRF,2CR	Relay, DPDT, 10A, 220VAC Contacts, 120 VAC 50/60Hz Coil, VDE Approved
CRF,2CR	Relay Socket, DPDT, 10A, 220VAC, Surface or DIN Rail Mount
1CR	Relay, DPST, 25A, 220VAC Contacts, 110 VAC 50/60Hz Coil, VDE Approved
1TMR	Timer, Delay on Break, 20 Minute Delay Time, 1 A, 120 VAC 50/60 Hz
1TEMPCON	Dynapar Temperature Controller, 1/16 DIN, Type K Input, 4 VDC Output, 0.5 Sec. Cycle Time
1POT	Digital Potentiometer, 3 Digit, 5K, 2 Watt, 0.1%
1R	Resistor, Metal Oxide Film, 2 Watt, 5%,47K
1SSR	Solid State Relay, 24-330VAC, 40A Output, 4-20VDC Input, w/ Safety Cover
1TS	Terminal Strip, 12 Position, Type G 5/12
1TS	Terminal Strip, 6 Position, Type G 5/6
3CR	Electrical Subassembly, R10 Relay Socket, 2 Pole
3CR	Relay, Super Sensitive, SPDT, 2A, 155VAC Contacts, 5 VDC Coil
CRM,CRF,2,3CR	Relay Mounting Track, DIN Style, 3 Ft. Extruded Aluminum Section
2XFMR	Current Transformer, 600 Turns, 600 VAC Working Class, 50/60 Hz
1,2FU	Fuse Holder, IEC 5x20mm Fuses, 10A, 250VAC, 16A, 120VAC, VDE Approved
1FU	Fuse, IEC 5x20mm, Low Breaking, Time Delay, 250V, 1.6A
2FU	Fuse, IEC 5x20mm, Low Breaking, Time Delay, 250V, 1A
5LT	Ind. Light, 125 VAC Neon, Amber, 0.5" Round Snap-in Panel Mount, 0.250 Tabs
6LT, 7LT	Ind. Light, 125 VAC Neon, Red, 0.5" Round Snap-in Panel Mount, 0.250 Tabs
1TVS	Transient Voltage Surge Suppressor (MOV), 130VAC, 20mm Disk
2TVS	Transient Voltage Surge Suppressor (MOV), 275VAC, 20mm Disk

1.7 Specifications

Input power		208-240VAC 15A 3500 Watts, 50/60Hz single phase
Heating	- Stamped foil IR elements	20.3cm (8.00") wide x 38.7cm (15.25") long - 1500 Watts, 240V
Vertical Oven	Upper Position	10cm ((3.9"))
Clearance	Lower Position	5.6cm (2.2")
Effective Heat Zone - Horizontal		35.5cm (14")
Fuses	1FU	5x20 mm IEC, 1.6A Time Delay Low Breaking
	2FU	5x20 mm IEC, 1A Time Delay Low Breaking
Temperature Control		Dynapar Temp. Control w/ Type K T/C interface
Operating Temperature		Ambient to 700°C maximum
Sound Level		Less than 70dB(A)
Conveyor Speed		15.2 to 152.4 cm/min (0.5 to 5.0 ft/min) (100 to 999 pot setting)
Potentiometer Setting	Speed (cm/min)	Speed (ft/min)
100	15.2	0.5
200	30.5	1.0
300	45.7	1.5
400	61.0	2.0
500	76.2	2.5
600	91.4	3.0
700	106.7	3.5
800	121.9	4.0
900	137.2	4.5
999	152.4	5.0
Conveyor Dimensions		76cm (30") W x 99cm (39") L x 42cm (16 ½") H
Conveyor Weight		91 Kg (200 lb)
Electrical Enclosure Dimensions		22cm (8 ½") W x 46cm (19") L x 17cm (6 ½") H
Electrical Enclosure Weight		8 Kg (17 lb)
Shipping Case		114cm (45") x 135cm (53") x 64cm (25") high

2 PREVENTING EQUIPMENT DAMAGE

1. To prevent over heating of conveyor belt, do not set the speed potentiometer to less than 100.
2. For normal shutdown, press the OFF ("O") button. When the machine cool down cycle completes (20 minutes), the conveyor and fans stop running, and the cool down lights turn OFF the circuit breaker and unplug the machine. Do not attempt to bypass the circuit breaker.
3. For normal maintenance and repair, after the first cool down cycle, restart the machine by pressing the ON ("I") and immediately press the OFF ("O") button again. When the second cool down cycle completes, turn off the circuit breaker and unplug the machine. Do not attempt to bypass the circuit breaker.
4. Do not set the temperature above 600°C. Operating the Tunnel Oven above 600°C will shorten the life of the Heater Elements.
5. Do not cover the fan vents. Covering the vents by setting objects on or next to them may cause uneven heating, or over heating of components.
6. An exposed thermocouple wire due to abrasion of the insulation will cause an over temperature condition which can destroy components of the Tunnel Oven and cause inconsistent processing of assemblies. When replacing the covers, ensure that no wires get pinched between the cover and the frame.
7. Excessive conveyor belt tension can cause premature belt wear. Tension the belts as called out in section 5.3.1 of this manual.
8. Emergency Stop: In the case of a product catching fire, excessive smoke, sparks, grinding noises, or any other signs of malfunction, press the Emergency Stop button. Then (with gloved hands) raise the Tunnel Oven Top Assembly with one hand, and manually remove any assemblies which may be in the heating chamber to prevent fire damage. Contact Maintenance Personnel to investigate the cause of the problem before restarting the machine.

Note: Such malfunctions are the only reasons to press the E-Stop while the belts and fans are still running. DO NOT use this as the normal shut down procedure as it will defeat the cool down circuit.

9. Use only as advised: This machine was designed for use with TE approved products only.

3 SETUP

3.1 Unpacking, Transport, Handling and Storage

1. The Model 105 has a mass of 99 Kg. When unpacking, transporting, handling or moving the unit to storage, it is recommended that no less than two persons or a lift truck be used for the process. When storing the unit it should be placed in a suitable crate 114cm x 135cm x 64cm tall, and stored indoors away from any harmful effects of weather or other hazards.
2. Remove the processor from its shipping container and check for damage. Inspect the shipping container and processor for any evidence of damage during shipment. If you believe there has been damage, contact the shipping agent immediately.
3. Set the processor on a flat, level surface. Choose a work area with enough room around the processor for loading and unloading wire harnesses. Also allow room for routine maintenance and repair.
4. Provide adequate ventilation. Allow enough clearance above and around the processor so that the fans can circulate cooling air without obstruction. Do not place anything on the upper chamber or cover the fan louvers.
5. Remove packing material from between the heaters. Packing material has been placed between the heating elements to prevent vibration damage during shipment. Discard this material.

3.2 Top Assembly Adjustment

The M105 tunnel oven has two upper housing height positions. The unit is shipped with the top engaged in the upper (4 inch nominal oven clearance) position. A second lower position (2.25 inch nominal oven clearance) is designed into the unit. If your parts are 2 inches or less in height, it is recommended that the Oven Top Assembly be placed in the lower position. To make this change, follow the steps detailed below.

Note: If you plan to use the M105 Tunnel Oven in the 4" nominal position, the below steps may be skipped. Always perform this operation with the control box power cord unplugged from the facility's power outlet, and the umbilical cord unplugged from the machine.

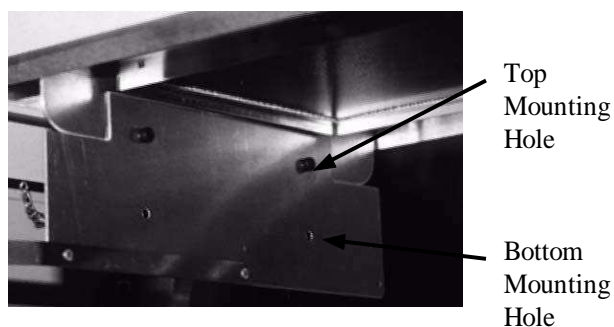

Left Heat Shield

1. **Remove Oven Top Cover.** Remove the Top Cover by turning the four (4) quarter turn fasteners counter-clockwise and lifting the cover vertically from the machine.
2. **Install the Shipping Support.**

Note: If you are just unpacking the unit, the Shipping Support is already installed.

Remove the two (2) M8 button head screws with flat washers from the right side belt guard. Install the Shipping Support using the two (2) M8 button head screws with flat washers and placing them through the bottom two (2) holes of the support.

3. **Remove the Left and Right Side Heat Shields.** These are removed by loosening two (2) M5 socket head cap screws.

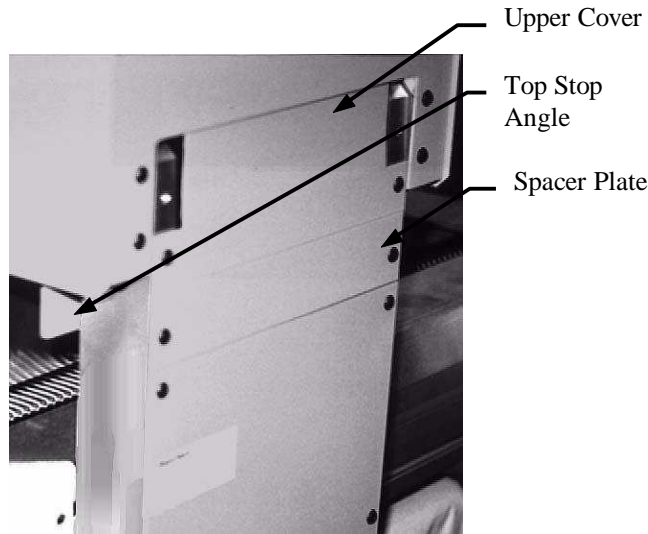

Left Side of Tunnel Oven

4. **Remove the Upper Cover from between the Pivot Shaft Stands on the left side of the unit.** This is upper most cover that is fastened to the stationary Pivot Shaft Stands (not fastened to the moveable top of the unit) and resembles an upside down "T". The Upper Cover is removed by loosening two (2) M5 button head screws.
5. **Remove the Spacer Plate between the Pivot Shaft Stands.** This is the 1.75" high plate located beneath the right side top cover you just removed. The Spacer Plate is removed by loosening two (2) M5 button head screws. Place the Spacer Plate in a safe location as it will be required when the upper Oven Top Assembly setting used.
6. **Remove the Top Stop Angle.** The Top Stop angle is located on the inside of the Pivot Shaft Stands and contains the Top Lock Pin, tether chain and mounting clip. Its purpose is to hold the Oven Top Assembly in a horizontal position when the Shipping Support is removed. The Top Stop angle is removed by loosening four (4) M5 socket head screws.
7. **Reinstall the Top Stop Angle.** Move the Top Stop angle down to the lower set of mounting holes a reinstall it using the screw you just removed.
8. **Remove the Pivot Shaft.** Loosen and remove the two (2) M6 socket head set screws using a 3 mm hex wrench. Supporting the Oven Top Assembly, slide the pivot shaft out of the Pivot Stands and bushing blocks.
9. **Reinstall the Pivot Shaft.** Move the Oven Top Assembly down to the lower Pivot Shaft holes and slide the pivot shaft back into the bushing blocks and of the Pivot Stands. Make sure the Pivot Shaft is centered and the flats are aligned with the set screw holes. Replace and tighten the two (2) M6 socket head set screws.
10. **Ensure electrical wiring is neatly routed.** The wiring that powers the Oven Top Assembly must be positioned so that the Top Cover and fasteners will not pinch or damage the wire bundle in either the fully opened or fully closed position.
11. **Replace covers and shields.** This includes the Left and Right Side Heat Shields, Left Side Upper Cover, and the Oven Top Cover. The Left and Right Side Heat Shields must be attached using the bottom two (2) holes when Oven Top Assembly is in the lower position.

3.3 Removing Shipping Support.

Removing Shipping Support. Before using the M105 Tunnel Oven, the Shipping Support may be removed. Loosen and remove two (2) M8 button head screws with flat washers to remove Shipping Support. Replace the two (2) screws / flat washers to keep right side belt guard secure to the side rails of the conveyor. It is recommended that the Shipping Support and shipping container be stored in a safe place for possible later use should the unit need to be shipped to another location. The shipping support is also used for changing the Oven Top Assembly adjustment. **Shipping Support must be reinstalled before shipping the unit or serious damage may occur.**

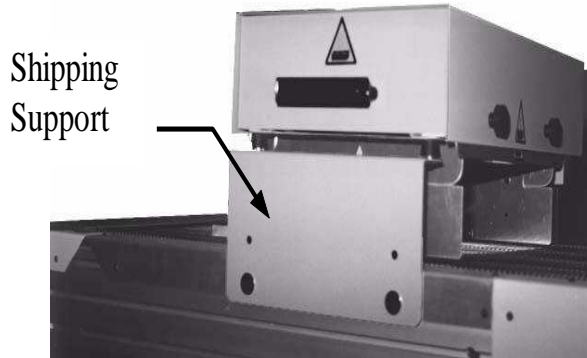

Tunnel Oven with Shipping Support Installed

3.4 Inspection (Power Off)

At the completion of the unpacking sequence, follow these steps to inspect the Tunnel Oven before making any electrical connections. If you believe there is damage that may have been caused during shipping, contact the shipping agent immediately.

1. **Inspect the Heater Elements for damage.** Visually check the Heater Elements for evidence of cracking or chipping of the glass face during shipment. The heater screws should be snugly fastened to heater trays.
2. **Ensure that the covers are in place and secure.** There are four (4) quarter-turn fasteners that secure the top cover. All other covers and guards are secured with M4 or M5 screws.

3.5 Electrical Connections



Electrical Connections Should Be Carried Out By a Qualified Electrician

1. **Attach an appropriately rated power plug to the end of the power cord.** A 250V, 15A or greater plug is recommended. This plug serves as the disconnecting means for the machine during service operations. The power cord insulation colors are defined below.

Brown	=	L1
Blue	=	L2
Green/Yellow	=	PE Ground (Protective Earth)
2. **Connect the umbilical cord plug (PL1) from electrical enclosure to mating receptacle on conveyor (PL1).**

3. **If an auxiliary E-stop was ordered/provided with the M105. Remove the PL2 jumper plug from the rear of the fix mounted E-stop and connect PL2 from the flying lead of the Auxiliary E-stop to the mating receptacle (PL2).**
4. **Connect installed Mains plug to an appropriate 230VAC supply receptacle.** A 15A or larger service is required.

Note: This unit is designed for industrial use only. As such, it is to be connected to an industrial power system. This unit is not intended to be connected to a public power system.

3.6 Inspection (Power On)

When the Power Off inspection, and the electrical connections sequence have been completed, follow these steps to complete the inspection and set up of the Tunnel Oven.

1. **Switch the Circuit Breaker On.**
2. **Ensure the Emergency Stop is not depressed.** A ¼ counter-clock wise turn will release the E-Stop.
3. **Press the ON ("I") button.** With the temperature set above ambient and the conveyor speed control set above 100, the heaters, conveyor, and fans will begin to function.
4. **Set the temperature controller to 600°C, and the speed control potentiometer to 999 (maximum).**
5. **Change the digital-speed control from maximum (999) to minimum (100)** to verify that the belt speed increases and decreases smoothly, with no jerky motion or excessive noises.
6. **Wait approximately 5 minutes for the temperature to reach its setpoint.** When this occurs, the Processor Ready Indicator will go on.
7. **The lower display on the temperature controller face indicates the temperature set point, the upper display indicates the actual Heater Element temperature.** Both displays should read within 2°C of the same temperature during normal operation.
8. **Press the OFF ("O") button.** The conveyor and fans will continue to run for 20 minutes. At that point the Heater Elements will have cooled to a safe temperature and the conveyor and fans will turn off and all displays will power off.

Note: Using the Emergency Stop or circuit breaker as the normal shut down procedure defeats the automatic cool down circuit and will cause heat damage to the Tunnel Oven.

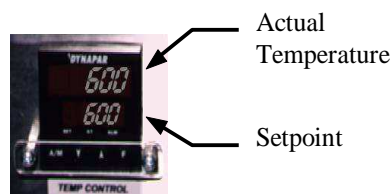

Temperature Controller

4 Operation

After the Tunnel Oven has been set up and inspected as described on the preceding pages, read the following warnings carefully and proceed with the steps in sections 4.1 to 4.3 for normal operation.

WARNING!	
	<ul style="list-style-type: none"> ■ Only trained qualified personnel are to operate this machine. To minimize the risks of burns, electrical shock, or other injuries, all safety precautions must be observed. ■ Because this piece of equipment is first and foremost an oven, it contains hot components and surfaces which can cause burns. The conveyor belt and workpieces exiting the oven will be hot. Protective clothing and equipment such as cotton gloves, long sleeved cotton workshirt and protective eye wear are required for safe operation. ■ Opening the electrical panel while the machine is powered may cause electrical shock. Always press the OFF ("O") button (if machine is hot, allow it to cool down), turn OFF the circuit breaker, and unplug the Tunnel Oven prior to any electrical maintenance or repair. ■ If hands, hair, clothing, or any other foreign objects are caught by the Tunnel Oven's moving parts, you could be injured and the equipment could be damaged. Operate the Tunnel Oven with all guards and covers in place. ■ If you open the top of the Tunnel Oven and do not use the Top Lock Pin, the top may fall and cause injury to the operator and damage the Tunnel Oven. Always use the top lock pin, and ensure it is fully seated its hole on the Pivot Block when opening the top. (Top cover must first be removed to use the Top Lock Pin. See "Top Lock Pin" in section 1.4) ■ Emergency Stop - In the case of a product catching fire, excessive smoke, sparks, grinding noises, or any other signs of malfunction, press the Emergency Stop button. Then (with gloved hands) raise the Tunnel Oven Top Assembly with one hand, and manually remove any assemblies which may be in the heating chamber to prevent fire damage. Contact Maintenance Personnel to investigate the cause of the problem before restarting the machine. Note: Such malfunctions are the only reasons to press the E-Stop while the Tunnel Oven is still running. ■ Do not use the circuit breaker or Emergency Stop as your normal shut down procedure as it will defeat the cool down circuit and will cause heat damage to the Tunnel Oven. ■ To keep the Tunnel Oven in optimum working condition, please follow all of the maintenance procedures described in Section 5.1 and 5.2. ■ This machine is designed for use on industrial power systems. Do not connect it to a public power system. ■ This machine was designed for use with TE approved products only. Always use TE recommended process settings.

4.1 Power On and Warm-up

1. **Verify that the machine is plugged in to the proper power source, that the circuit breaker is ON, and the E-Stop is not depressed and the speed control is set to 100 or greater.**
2. **Press the ON ("I") Button**
3. **Set the temperature controller to the correct set point temperature for your application.** Remember, Temperature above 600°C will greatly reduce Heater Element life.
4. **Set the belt speed to the proper setting for your application.** Always set the belt speed at or above 100. A setting of less than 100 will cause belt over heating. Refer to the chart in the Specifications section 1.6 to translate dial setting to actual belt speed.
5. **Take note of indicator lights while machine is warming up.** The control power light located between the ON ("I") and OFF ("O") buttons on the control enclosure will be illuminated. The Temperature Controller will display Heater Element temperature and setpoint temperature. No other indicators will be illuminated.
6. **Allow the Tunnel Oven to warm up for about 10 minutes.** It takes about 5 minutes for Heater Elements to reach the set point, allow an additional 5 minutes of soak time and processing can begin.

4.2 Loading and Unloading

At the completion of the Power On and Warm-up sequence, follow these steps to process workpieces.

1. **Prepare the workpiece.**
2. **Place workpiece onto conveyor belt making sure the portion to be heated is aligned with the heat zone.**
3. **Allow workpiece to travel through the oven.**
4. **Remove the workpiece from the conveyor belt after it has cleared the cooling fans in the rear of the conveyor, or simply allow the workpiece to fall into a collection tray positioned at the end of the conveyor.**

4.3 Power OFF and Cool-Down

1. **At the end of the work shift, press the OFF ("O") button.** The conveyor and the fans will continue to run for 20 minutes, until a safe temperature has been reached, at which time they will shut off automatically.
2. **Take note of indicator lights while machine is cooling down.** The control power light located between the ON ("I") and OFF ("O") buttons on the control enclosure will be illuminated. The Temperature Controller will display Heater Element temperature and setpoint temperature. The Cool Down indicator light located on the Emergency Stop Enclosure will also be illuminated.



Note: DO NOT use the Circuit Breaker or E-stop for the normal shutdown procedure. This defeats the automatic cool down cycle and will cause heat damage the Tunnel Oven.

5 MAINTENANCE

The Model 105 Tunnel Oven is a very low maintenance machine, however, given a few minutes each week will ensure reliability and the long life of the Tunnel Oven. The following are guidelines for daily, weekly, and monthly maintenance procedures that will keep the Model 105 Tunnel Oven in optimum working condition. Don't wait until the Tunnel Oven has problems to give it some attention.

WARNING!	
	<ul style="list-style-type: none"> ■ These procedures should be performed only by trained qualified personnel. To minimize the risks of burns, electrical shock, or other injuries, all safety precautions must be observed. ■ Always perform maintenance operations on a cool machine. If the machine is already hot, place the machine in cool down mode by pressing the OFF ("O") button. The conveyor and the fans will continue to run for 20 minutes. At this point, the Heater Elements will likely remain too hot to allow work on the machine. To avoid any burns or injury, initiate a second cool down cycle by pressing the ON ("I") button, and the immediately pressing the OFF ("O") button, wait for the cool down to complete. The machine should now be cool enough to begin maintenance. (See item 3 in section 2.0 "Preventing Equipment Damage")

Note: Do not use solvents for cleaning. Solvents are unnecessary and may damage some components of the Tunnel Oven.

5.1 Daily Maintenance

Before the daily production begins, while the Tunnel Oven is cool, take a few minutes to perform the following steps.

1. **Inspect and clean any dirt from the surfaces of the Tunnel Oven.** Use a damp cloth to clean any stainless steel or painted surfaces. Black oxide steel surfaces should be cleaned with a dry cloth. A household spray cleaner such as Formula 409 or Windex may be used on stainless steel or painted surfaces to remove dirt that a damp cloth will not remove. Likewise dirt on black oxide steel surfaces that cannot be removed with a dry cloth can be removed using a cloth dampened with WD-40 or a lightweight oil.
2. **Inspect and the Heater Elements.** Look for any accumulation of debris or film on the Heater Elements. If necessary, clean the black glass surface of the Heater Elements using a damp cloth. Windex may also be used for this purpose.
3. **Verify that the temperature controller is not set above 600°C.** Operating the Model 105 Tunnel Oven at a set point above 600°C will shorten the life of the Heater Elements.
4. **General condition check.** As the Tunnel Oven warms up for normal operation, check the general condition of the Tunnel Oven. Ensure that all the fans are working properly, and listen for any abnormal noises. The conveyor should be run smoothly without a jerky motion. Check to see that all guards and covers are securely in place. Make any repairs or adjustments necessary to return the unit to proper working order.

5.2 Semi-Annual Maintenance

Take time every six months before daily production begins to perform the following procedures.

5.2.1 Clean the inside of the Tunnel Oven.

With the Tunnel Oven still cool at the beginning of the day, turn off the circuit breaker and unplug the unit. Remove all guards and covers. This includes the Rear Belt Guards, Front Belt Guards, Side Belt Guards, Top Cover. Using an air hose or cloth, clean any dirt, dust, tubing, or anything which has been trapped inside the Tunnel Oven.

5.2.2 Change temperature setpoint to 0°C.

With the Tunnel Oven still cool, plug the Tunnel Oven into its power source and turn on the circuit breaker on. Press the ON ("I") button, then immediately press the OFF ("O") button to put the Tunnel Oven in cool down mode. Change temperature setpoint to 0°C. This will prevent the Tunnel Oven from heating up in the subsequent steps of the procedure.

5.2.3 General condition check.

As the conveyor runs, check the general condition of the unit and listen for abnormal noises. Ensure that all the fans are working properly. Make any repairs or adjustments necessary to return the unit to proper working order.

5.2.4 Check the Conveyor Belt for tension.

Belt tension can be determined by observing the length of belt in contact with the lower glide rails. If there is no contact on this glide rails, the belt is overly taught. If there is more than eighteen (18) inches of contact, the belt is too loose.

5.2.5 Inspect the motor brushes.

Remove the brushes from the motor brush receptacles. If they are not at least ¼ inch long, replace them.

5.2.6 Lubricate Drive Chain.

Use a commercially available roller chain lubricant on the steel drive chain.

5.3 Maintenance Procedures

Always perform maintenance procedures on a cool machine.

5.3.1 Belt Tension Adjustment

If the belt is too loose, a number of links will need to be removed to restore the tension to proper operating condition. Before starting, assess the number of links to be removed by squeezing a number of links together until the belt reaches the desired tension level (see 5.2.4). The distance you manually shrink the belt by this process should help you determine the number of links to remove. Every 0.3 inches the belt is squeezed represents 1 link to be removed.

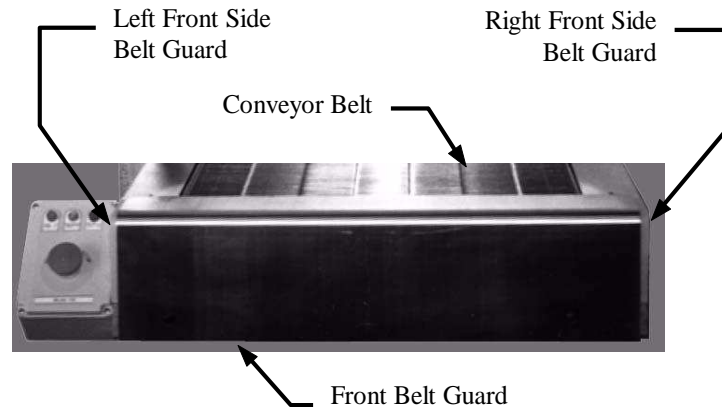

Belt Tensioning Steps:

1. Run the conveyor in Cool down Mode by pressing the ON ("I") button, and the immediately pressing the OFF ("O") button. Watch the belt and find the previous splice link. Stop the conveyor belt when the splice link is in a convenient working position in the front portion of the conveyor. In this case the conveyor is stopped by pressing the E-Stop button. (Previous splices are normally identified by spice clips or slight deformation of the link in the belt. If you can not find the splice link, pick any link that is convenient).
2. Turn off circuit breaker and unplug the power cord from the facility's power outlet. Separate the umbilical cord from the unit for ease of working on the machine.
3. Remove four (4) screws from panel that houses the umbilical cord connector. This panel must be loose to allow for the subsequent removal of left center belt guard.
4. Remove front belt guard, and all side belt guards. This includes the front, center, and rear left side belt guards and the front, center, and rear right side belt guards.
5. Remove spacer clips on front roller bearings.
6. Note the position of the front roller for later repositioning. Use a 13mm open end wrench to turn the bearing hex bolts until they are loose enough to allow the roller to slide.
7. Loosen the four (4) screws that secure the front guide rail/fan tray assembly to the conveyor sides. Make sure the screws are sufficiently loose to allow the front guide rails to be lifted above the front roller.
8. Lift the front guide rail plate from the conveyor side extrusions, and slide front roller under the front guide rails. This will allow sufficient 'slack' room for resplicing the belt.
9. Use a diagonal cutters to cut the previous splice link into pieces which can easily be removed from the belt.
10. Remove the number of links required for adequate belt tension (as determined in the prelude to this procedure).
11. Resplice the belt using two (2) three position splice clips or one of the seven position links just removed. More information on the spicing procedure and animated instructions on installing splices can be found on the internet at URL <http://www.wirebelt.com>.
12. Slide the front roller forward until it clears the guide rails, then reposition the front and rear guide rail plates back into their original position making sure the 'T' nuts slide back into their slots on the conveyor side extrusions.
13. Reposition the front roller to its initial position and tighten into place. (Generally, this position is so that its foremost surface of the roller is flush with the foremost vertical surface of the conveyor side extrusions.)
14. Retighten front and rear guide rail plates.
15. Replace remaining components in reverse sequence to which they were removed.

5.3.2 Upper Heater Element Replacement

1. Turn off circuit breaker and unplug the power cord from the facility's power outlet.
2. Remove upper right side heat shield mount to expose Upper Heater Element power and thermocouple connectors.
3. Raise top of the tunnel oven to full vertical position and lock it into position with the Top Lock Pin.



Note: Always secure Tunnel Oven Top with in the upright position with the Top Lock Pin. Failure to do so can result in serious personal injury and/or damage to the unit.

4. Remove the two (2) screws securing the Upper Left Heat Shield Mount (the heat shield nearest the lift handle) in place. This will expose the Upper Heater Element connectors.
5. Unplug the Upper Heater Element power and thermocouple connectors.
6. Remove one of the button head cap screws securing the Upper Heater Element in place.
7. Use one hand to hold the Upper Heater Element while removing the second the button head cap screw.
8. Gently remove the Upper Heater Element from position while sliding cables out of the access slot provided.
9. Replace components in reverse sequence to which they were removed.

5.3.3 Lower Heater Element Replacement

1. Turn off circuit breaker and unplug the power cord from the facility's power outlet. Separate the umbilical cord from the unit for ease of working on the machine.
2. Remove four (4) screws from panel that houses the umbilical cord connector. This panel must be loose to allow for the subsequent removal of left center belt guard.
3. The Lower Heater Element connector is housed under the left side belt guard. To provide access it will be necessary to remove the front belt guard, and left side belt guards. This includes the front, center, and rear left side belt guards.
4. Unplug Lower Heater Element by rotating the collar on the plug.
5. Remove the two button head cap screws securing the Lower Heater Element in place. This is done by placing a 3mm hex key through the conveyor belt and into the head of the screw.
6. Lift the right side of the belt from the guide rails and retrieve the screws.
7. Lift the right side of the belt from the guide rails and slide out the Heater Element.
8. Slide in the new Heater Element.
9. Replace components in reverse sequence to which they were removed.

6 TROUBLESHOOTING

WARNING!	
	<ul style="list-style-type: none"> ■ Some troubleshooting procedures require the Tunnel Oven's power to be ON. To minimize the risk of burns, electrical shock, or other injuries, these procedures should be performed only by a qualified Maintenance Person, and all safety precautions must be observed. ■ Wear protective gloves to prevent possible burns or electrical shock. ■ The Heater Elements remain hot after the conveyor and fans stop moving. To avoid any burns or injury during maintenance, initiate a second cool down cycle and wait for it to complete, before beginning. (See item 3 in section 2.0 "Preventing Equipment Damage")

6.1 Troubleshooting Guide

PROBLEM	POSSIBLE CAUSE	CORRECTIVE ACTION
No power in the Tunnel Oven.	Main Power source not connected.	Connect power.
	Emergency Stop is depressed.	Turn and release Emergency Stop.
	Circuit breaker is off.	Turn on breaker.
	Over Temperature Switch is activated.	Wait for switch to cool down.
	Over Temperature Switch is faulty.	Replace switch.
	Circuit breaker is defective.	Replace circuit breaker.
	ON ("I") button has not been pressed.	Press the ON ("I") button.
	ON ("I") button is defective.	Replace the ON ("I")/OFF ("O") button.
	Fuse 1FU or 2 FU blown.	Replace fuse.
	Cool Down timer is defective.	Replace as necessary.
	CRM is defective.	Replace CRM.
Heater Elements will not reach set point.	Control is transformer defective.	Replace 1XFMR.
	Heater Elements failed.	Replace Heater Elements.
	Thermocouple lead wire is faulty between controller and Heater Element.	Repair as necessary.
	Thermocouple in Upper Heater Element is faulty.	Replace Upper Heater Element.
	Solid state relay is defective.	Replace 1SSR.
	Temperature controller defective	Replace controller.
	Master Control Relay Defective	Replace CRM.
Temperature control varies.	Temperature controller not programmed correctly.	Reset controller parameters.
	Thermocouple lead wire is faulty.	Repair the thermocouple wire as necessary or replace the Upper Heater Element.
	Temperature controller is programmed incorrectly.	Reset internal parameters.
	There is excessive air movement around the Tunnel Oven.	Check for external fans or air conditioning which may be blowing excessive air at the Tunnel Oven.

6.1.1 Troubleshooting Guide (continued)

PROBLEM	POSSIBLE CAUSE	CORRECTIVE ACTION
No Heat in the Tunnel Oven.	Solid state relay is defective.	Replace 1SSR.
	1CR is defective.	Replace 1CR.
	CRM is defective.	Replace CRM.
	Temperature controller set point set too low.	Increase set point as necessary.
	Temperature controller is programmed incorrectly.	Reset parameters.
	Temperature controller is defective.	Replace the controller.
	Electrical connections are faulty.	Ensure the integrity of connections.
Heater Elements go "Over Temperature".	Solid state relay is defective.	Replace 1SSR.
	Fan is defective.	Replace the defective fan.
	Thermocouple lead is shorted.	Repair short.
	Temperature controller is defective.	Replace controller.
Automatic cool down isn't functioning.	Cool down timer is defective.	Replace 1TMR.
	Electrical connections are faulty.	Ensure the integrity of connections.
Fans do not operate.	A fan is defective.	Replace the defective fan.
	Fan wiring is faulty.	Check wiring and connections.
	Electrical connections to the fan are faulty.	Ensure the integrity of connections.
	Fan is defective.	Replace fan.
Conveyor does not move.	Main Power source not connected.	Connect power.
	Set screws and keys loose on drive sprockets.	Replace/reposition keys, tighten set screws.
	Electrical connections to the motor are faulty or motor is unplugged.	Check all connections from the motor controller to the motor. Check motor plug.
	Motor is defective.	Inspect the motor brushes. Replace brushes or motor as required.
	Speed dial set to less than 100.	Increase speed setting.
	Motor controller is defective.	Replace motor controller.
	Speed potentiometer is defective.	Ensure that the speed varies through the entire range of the potentiometer. Replace as necessary.
No variable speed control.	Motor controller is defective.	Replace controller.
	Digital speed control is defective.	Replace as necessary.
	Electrical connections between potentiometer and motor controller are faulty.	Ensure the integrity of connections. Repair as required.

6.2 Heater Element Test

If a heater element has failed, the Heater Fault LED on the front control panel will light. The following procedure is to determine which heater element has failed.

1. If Tunnel Oven is not already cool, allow the machine to cool down. (Follow instructions in item 3 in section 2.0 "Preventing Equipment Damage"). When the machine is cool, turn off circuit breaker, and unplug the power cord.

2. Disconnect the umbilical cord from the machine.
3. Measure the element resistance. The Upper Heater Element resistance can be measured between pins 1 and 7 of the panel mount umbilical cord receptacle (1PL). The Lower Heater Element resistance is measured between pins 9 and 8 of the same receptacle. The resistance of the Heater Element may range from 34 to 45 Ω .

6.3 Thermocouple Check

Note: The Upper Heater Element and thermocouple are a single unit. If the wire or insulation cannot be repaired, the Upper Heater Element must be replaced.

1. When the machine is cool, turn off the circuit breaker, and unplug the power cord.
2. Remove the top sheet metal cover.
3. Lift the top of the Tunnel Oven and lock it in place with the Top Lock Pin.
4. Disconnect the thermocouple plug and measure the resistance across the pins on the end connected to the Upper Heater Element Thermocouple (male side of connector). If the resistance is less than 2 Ω , the fault likely lies between the female side of the connector and the temperature controller. If the resistance is greater than 2 Ω , but less than infinity ($\infty \Omega$), replace the Upper Heater Element. If the resistance is infinity ($\infty \Omega$), the wire is broken. Trace the circuit through the length of the wire. If a break is found, it can be repaired, otherwise, the break is likely inside the Upper Heater Element and the element must be replaced. Continue with the following procedure.
5. Unplug the temperature controller from its housing. This is done by firmly grasping the sides of the front control panel and applying a strong forward force in conjunction with a slight side to side rocking force. The front 1/4" of the control panel and all active electrical components will separate from the control housing. All terminals of the control housing will then be open circuit.
6. Open the control enclosure cover to provide access to rear of the Temperature Controller.
7. Attach Ohmmeter to thermocouple lead wires. With the thermocouple connector still separated, remove female receptacle from the mount and then remove the cable clamp/cover from the female receptacle. Attach Ohmmeter leads to the two thermocouple sockets which are now exposed. Place a jumper across terminal 4 and 5 on the rear of the Temperature Controller. The resistance should be less than 2 Ω . If the resistance is greater than this value, the wire is broken. Remove the jumper. The resistance should read infinity ($\infty \Omega$). If the resistance is less than infinity ($\infty \Omega$), the wire is shorted. Continue with the following procedure. Repair or replace either the wire or the Upper Heater Element as appropriate.

6.4 Cool Down circuit test.

When the OFF ("O") button is pressed, it actuates an electronic timer (1TMR) located in the control enclosure. The following test must be performed with the power on and the control enclosure open.

Caution! Only a qualified electrician should perform this test, as power to the Tunnel Oven is required. Electrical insulating gloves should be worn and all electrical safety precautions followed when performing this procedure.

1. **Measure the timer input power.** While the Tunnel Oven is on and operating normally, measure the voltage between terminal #2 and #3 on 1TMR (wires #4 and #2). The voltage should read approximately 120 VAC.
2. **Measure the timer output power.** While the Tunnel Oven is on and operating normally, measure the voltage between terminal #1 and #3 on 1TMR (wires #7 and #2). The voltage should read approximately 120 VAC.

3. **Measure the timer "initiate" signal.** While the Tunnel Oven is on and operating normally, measure the voltage between terminal #6 and #3 on 1TMR (wires #9 and #2). The voltage should read approximately 120 VAC. Press the OFF ("O") button, the voltage should drop below 100 VAC. (The actual reading will vary depending on the type of meter used.)

6.5 Solid State Relay/Temperature Controller Test

The temperature controller uses a time proportioning 12 VDC signal to control the solid-state relay.



Caution! Only a qualified electrician should perform this test, as power to the Tunnel Oven is required. Electrical insulating gloves should be worn and all electrical safety precautions followed when performing this procedure.

Note: The first part of this test is performed while the temperature controller is demanding full power to the Heater Elements. The second part of the test is performed with the temperature controller is demanding no power to the Heater Elements.

1. **With the temperature controller set to its normal operating setpoint ($\approx 600^{\circ}\text{C}$), allow the Tunnel Oven to cool by pressing the OFF ("O") button and waiting for the 20 minute cool down cycle to complete.**
2. **Open the control enclosure cover and remove the transparent cover on the solid state relay.** It snaps on and off.
3. **Press the ON ("I") button to power up the Heater Elements.**
4. **Plug in the unit, turn ON circuit breaker and press the ON switch.**
5. **Measure the input voltage on the solid state relay.** When full power is being demanded, the voltage across terminals #3 and #4 on 1SSR (wires #20 and #21) should be approximately 12 VDC. If no voltage is present, check the output of the temperature controller and the electrical connections between the temperature controller and the solid state relay.
6. **Measure the output voltage.** With 10 to 12 VDC across the input terminals of 1SSR, the output across terminals #1 and #2 (wires #2L1 and #4L1) should be approximately 0 VAC. If the voltage present is significant ($>15\text{VAC}$), the solid state relay is exhibiting an open circuit condition and should be replaced.
7. **Lower the set point of the temperature controller to 0°C .** This will result in the temperature controller demanding no power from the Heater Elements.
8. **Measure the input voltage on the solid state relay.** The voltage across terminals #3 and #4 (wires #20 and #21). The voltage should be approximately 0 VDC.
9. **Measure the output voltage.** The voltage across terminals #1 and #2 (wires #2L1 and #4L1) should be the line voltage (208 to 240 VAC). If there is no voltage present, check the voltage on the output of relay 1CR (wires #5L1 and #3L2). If no voltage appears across either 1SSR or 1CR, the solid state relay is shorted and must be replaced. If the line voltage shows up across the terminals of 1CR, 1CR must be replaced.

6.6 Over Temperature Switch Test

If the Over Temperature Switch has failed, the unit will not start when the ON ("I") button is pressed. If the ON ("I") button is held in the depressed position, and the red "Over Temp" indicator located on the control enclosure glows, in all likelihood, the Over Temperature Switch has either tripped or is defective. To positively resolve the issue, perform the following steps.

1. If Tunnel Oven is not already cool, allow the machine to cool down. Since the machine will not run, you will simply have to wait for the cooling to occur without the aid of the fans. When the machine is cool, turn off circuit breaker, and unplug the power cord.
2. Disconnect the umbilical cord from the machine.
3. Measure the Over Temperature Switch resistance. The Over Temperature Switch resistance can be measured between pins 15 and 19 of the panel mount umbilical cord receptacle (1PL). The resistance of the Over Temperature Switch must be under 2Ω.

6.7 Drive Circuit Test

The drive circuit consists of the motor, motor controller, and speed potentiometer.



Caution! Only a qualified electrician should perform this test, as power to the Tunnel Oven is required. Electrical insulating gloves should be worn and all electrical safety precautions followed when performing this procedure.

6.7.1 Motor Controller

1. **Open the Motor Controller Enclosure cover to gain access to the motor controller.**
2. **Press the ON ("I") button to start normal operation of the Tunnel Oven.**
3. **Measure the input AC voltage across terminals L1 and L2, wires #10A & #2A.** The voltage measured should be approximately 120 VAC. If it is not 120 VAC, check control power fuses (1&2FU). If control power is good, i.e. power is evident on temperature controller, wiring to the motor controller is defective.
4. **Adjust the speed pot to maximum speed (999).**
5. **Measure the DC output voltage.** With the speed set at maximum, the voltage measured across terminals A- and A+ (wires #11 & #12), should be approximately 65-130 VDC. If there is incoming voltage but no output voltage, the motor controller is probably defective.

6.7.2 Motor Resistance

1. **Turn off circuit breaker and disconnect the power from the Tunnel Oven.**
2. **Remove Motor Controller Enclosure cover.**
3. **Remove Motor Controller guard and disconnect motor leads from A+ and A- terminals.**
4. **Measure armature resistance.** Using an ohmmeter measure the resistance between motor leads. This resistance should be between 70 and 100Ω. If the resistance is higher or lower, replace the motor.

6.7.3 Motor Brush Inspection

1. **Remove the motor from the Tunnel Oven.**
2. **Unscrew the brush receptacles** located on either side of the motor casing and remove the brushes. They should be at least ¼ " in length. Replace as necessary.

Note: When reinstalling the brushes, ensure that they are seated in the same orientation as when they were removed.

7 CALIBRATION AND ADJUSTMENTS

7.1 Motor Controller / Speed Calibration

The motor controller must be calibrated every time one of the following occurs:

- Motor is changed.
- Motor Controller is changed.
- Speed Potentiometer is changed.

Note: Only the MIN and MAX trimpots are used for calibration purposes. The IR, and CL trimpots are set at the factory and should not be adjusted.

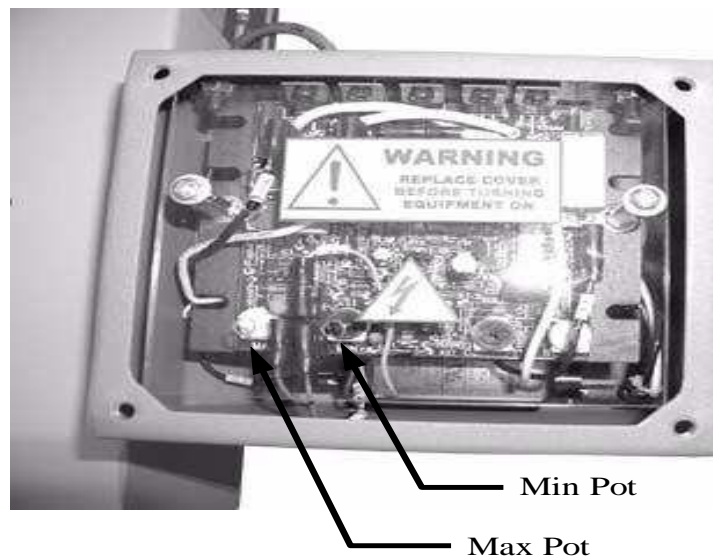

Motor Controller

It is recommended that this operation is performed on a totally cooled machine with a 20°C temperature setpoint and all top heat shields raised or removed. To determine conveyor speed you will need to measure the time required for the conveyor to travel a given distance. To accomplish this, place three pieces of masking tape on the right side aluminum belt guard that abuts the side of the conveyor belt. Place one piece near the front of the conveyor. This will be the 0" datum. Place a second piece 6" from the 0" datum, and a third piece 24" from the 0" datum. Mark the tape with a line so that you will have exactly 6" and 24" data from which to measure.

1. **Measure the conveyor speed at the 999 speed setting.** The target is 5.0 feet per minute (2 feet in 24 seconds). If the speed is not within limits, adjust the MAX. trimpot slightly in the clockwise direction to increase the speed, or counterclockwise direction to reduce the speed.

Note: Adjusting the MAX trimpot affects the MIN setting and vice versa.

2. **Place a marker on the front of the conveyor belt.** Using a stopwatch, begin timing when the marker passes the 0" datum. Stop timing when the marker passes the 24" datum. The time should read 24 ±1.2 seconds. If it is more, the conveyor is running too slow. If it is less, the conveyor is running too fast.
3. **Measure the belt speed at the 200 speed setting.** The target speed is 1.0 feet per minute (0.5 feet in 30 seconds). If the speed is not within limits, adjust the MAX. Trimpot slightly in the clockwise direction to increase the speed, or counterclockwise direction to reduce the speed.

4. **Place a marker on the front of the conveyor belt.** Using a stopwatch, begin timing when the marker passes the 0" datum. Stop timing when the marker passes the 6" datum. The time should read 30 ± 1.5 seconds. If it is more, the conveyor is running too slow. If it is less, the conveyor is running too fast.
5. **Repeat the above steps until the maximum and minimum speed targets are reached.** The process may take a few adjustments to meet both requirements.

7.2 Temperature Controller

The internal parameters of the temperature controller are preset at the factory. The only reason these parameters (other than temperature set point) should be changed is when calibrating the Model 105. It is a good idea, however, to periodically check to ensure that no one has tampered with the settings. See Section 7.2.2 for internal program parameters.

Temperature Calibration

1. Run the UHI-250 Temperature Probe through the centre of the machine at a belt setting of 200 and a set temperature of 600°C (1112°F). * The target probe temperature (calibrated) is 125°C +/- 5°C (257°F +/- 9°F at a belt setting of 200. If the average of the recorded probe temperatures is not within the limits, offset the temperature controller, as follows, to obtain proper calibration.
2. Run the UHI-250 Temperature Probe through the center of the machine a minimum of 3 times. Note the maximum temperature reading and calculate the average.
3. Enter into the "SETUP MODE" and scroll down to Temperature Offset (OFFS). Offset the controller 2 degrees for every degree differential from the target temperature of 125°C (257°F).
4. Repeat steps 2 and 3 until the target temperature has been reached.

7.2.1 Changing Temperature Set Point

The number in the bottom display is the set point and upper number is the actual heater element temperature.

1. **To change the temperature set point, press the "▽" or "△" keys.** The "▽" key decreases the value and the "△" key increases it. The set point is displayed in °C.
2. **In case of thermocouple failure,** an error message "OPEN" will appear in the upper display.

7.2.2 Parameter Settings and Temperature Controller Operation

The internal parameters of the temperature controller are preset at the factory; however, it is a good idea to periodically check to ensure that no one has tampered with them.

Note: If you are having trouble navigating the below described menus and cannot get out of one of the many controller modes, do not panic. The temperature controller will return to the Control Mode if there is no key entry activity for 2-1/2 minutes.

The Partlow temperature controller has five operating modes. The unit powers up in the Operator mode by default.

Operator Mode

The following table shows the parameters accessible from Operator Mode (OPtr). These parameters can be reached by pressing the ⏏ (Scroll) button.

Action	Upper Display	Lower Display	Description	Factory Setting
	Actual Temperature	Temperature Setpoint	Normal instrument operation	600
↻	Active Alarms	ALSt	2 = Alarm 2 active, 1 = Alarm 1 active (Visible only if an alarm is active)	N/A (read only)

Any value displayed in the Lower Display window that is not a read only parameter can be changed by pressing the Δ or ∇ button.

Mode Selection

To select a mode, press and hold the \cup button then depress the Δ button. Once in the select mode, use the Δ or ∇ button to locate the desired mode then press \cup to proceed within that mode.

The table below shows the five modes employed by the Partlow controller.

Action	Mode	Upper Display	Lower Display	Description
	Operator	OPtr	SLct	Normal instrument operation
∇	Auto-Tuning	Atun	SLct	Invoke Pre-Tune or Self-Tune
∇	Product Information	inFo	SLct	Partlow product information
∇	Configuration	ConF	SLct	Configure device
∇	Set Up	SEtP	SLct	Tailor settings

To exit from any mode, press and hold the \cup button then depress the Δ button. Select the new mode using the Δ or ∇ button, and enter the desired mode by pressing the \cup button.

Always return to the Operator (OPtr) mode to return to normal operation.

Configuration Mode

To select the Configuration Mode (ConF), press and hold the \cup button then depress the Δ button. Once in the select mode, use the Δ or ∇ button to locate the Configuration Mode then press \cup to proceed with the configuration. Use the Δ or ∇ button to change the value in the Upper Display until it matches the value shown in the table below, then press the "AUTO/MANUAL" button to register the value in the Upper Display window.

If you do not press the “AUTO/MANUAL” button after changing the parameter in the Upper Display, the setting will revert to the previous value.

Action	Parameter	Upper Display	Lower Display	Description
↻	Input Type	YC	inPt	Type K thermocouple
↻	Range Upper Limit	760	ruL	Upper Range for Scaling (°C)
↻	Range Lower Limit	0	rLL	Lower Range for Scaling (°C)
↻	Control Type	SnGL	Ctyp	Single control (heat only)
↻	Primary Output Action	rEV	Ctrl	Reverse acting (for heating)
↻	Alarm 1 Type	dE	ALA1	Alarm 1 = Deviation
↻	Alarm 1 Value	30	dAL1	Deviation Alarm = 30 °C
↻	Alarm 1 Hysteresis	1	Ahy1	Alarm 1 Hysteresis = 1 °C
↻	Alarm 2 Type	bAnd	ALA2	Alarm 2 = Band Alarm
↻	Alarm 2 Value	20	bAL2	Band Alarm = 20 °C
↻	Alarm 2 Hysteresis	1	AHy2	Alarm 2 Hysteresis = 1 °C
↻	Loop Alarm	diSA	LAEn	Loop Alarm disabled
↻	Alarm Inhibit	nonE	Inhi	No Inhibits
↻	Output 1 Usage	Pri	USE1	Use Output 1 for primary control
↻	Output 2 Usage	A2_r	USE2	Use Output 2 for Alarm 2, Reverse
↻	Output 3 Usage	A1_d	USE3	Use Output 3 for Alarm 1, Direct
↻	Display Strategy	2	diSP	Use second display strategy
↻	Configuration Lock Code	0	CLoc	Configuration Menu unlocked

To exit from Configuration Mode, press and hold the ↻ button then depress the △ button. Select the new mode using the △ or ▽ button, and enter the desired mode by pressing the ↻ button.

Always return to the Operator (OPtr) mode to return to normal operation.

Setup Mode

To select the Setup Mode (SEtP), press and hold the ↻ button then depress the △ button. Once in the select mode, use the △ or ▽ button to locate the Setup Mode then press ↻ to proceed with the setup.

Use the △ or ▽ button to change the value in the Upper Display until it matches the value shown in the table below, then press the ↻ button to register the value in the Upper Display window. There is no need to press the “AUTO/MANUAL” button to register the value when operating in the Setup Mode. Note that display values in the chart below that show a question mark (?) are read only or values that are determined by the user. They vary depending on user settings or the state of the machine.

Action	Parameter	Upper Display	Lower Display	Description
↻	Input Filter Time Constant	0.5	FiLt	Time constant of 0.5 second used for input filter
↻	Temperature Offset	?	OFFS	Actual value determined by factory or field calibration
↻	Primary Power	?	PPW	Power output (Read only)
↻	Primary Proportional Band	3.0	Pb_P	Proportional Band setting (Actual setting may vary slightly)
↻	Automatic Reset	.12	ArSt	Integrator time setting (Actual setting may vary slightly)
↻	Rate	.03	rAtE	Derivative time setting (Actual setting may vary slightly)
↻	Bias (Manual reset)	62	biAS	Bias setting is 62
↻	Setpoint Upper Limit	700	SPuL	Setpoint Upper Limit is 700 °C
↻	Setpoint Lower Limit	0	SPLL	Setpoint Lower Limit is 0 °C
↻	Primary Output Power Limit	100	OPuL	Control Output = 100% (Not limited)
↻	Output 1 Cycle Time	0.5	Ct1	Control output cycle time is 0.5 seconds
↻	Deviation Alarm 1	30	dAL1	Deviation Alarm = 30 °C
↻	Alarm 1 Hysteresis	1	AHy1	Alarm 1 Hysteresis Value = 1 °C
↻	Band Alarm 2	20	bAL2	Band Alarm = 20 °C
↻	Alarm 2 Hysteresis	1	AHy2	Alarm 2 Hysteresis Value = 1 °C
↻	Auto Pre-Tune	diSA	APt	Auto Pre-Tune capability is disabled
↻	Auto/Manual Control Selection	diSA	PoEn	Auto/manual control selection is disabled
↻	Setpoint Ramping	EnAb	SPr	Setpoint Ramping capability is disabled
↻	Setpoint Ramp Rate Value	-	rP	Setpoint Ramp Rate Not Applicable
↻	Setpoint	600	SP	Setpoint 600°C (factory setting – actual setpoint determined by application requirements)
↻	Setup Lock Code	0	SLoc	Setup Menu unlocked

To exit from Setup Mode, press and hold the ↻ button then depress the △ button. Select the new mode using the △ or ▽ button, and enter the desired mode by pressing the ↻ button.

Always return to the Operator (OPtr) mode to return to normal operation.

Automatic Tuning Mode

Variations in system dynamics may occur due to normally occurring differences in the thermal characteristics of heater elements originating from different manufacturing lots, different materials or changes brought about by improved heater element design. Therefore, if you find that the factory-installed parameters yield unsatisfactory performance, you may wish to perform a Pre-Tuning operation when replacing heater elements. To perform a Pre-Tuning operation you must enter the Automatic Tuning Mode.

Before performing the Pre-Tuning operation it is important to first allow the system to reach the setpoint operating temperature, then press the O (off) button and allow the actual temperature to fall at least 100°C below the setpoint temperature.

Press the I (on) button and immediately enable Pre-Tuning by following the steps below. Note that the table below details the parameters located in the Automatic Tuning Mode menu.

Action	Parameter	Upper Display	Lower Display	Description
↻	Pre-Tune	OFF	Ptun	Pre-Tune capability is disabled
↻	Self-Tune	OFF	Stun	Self-Tune capability is disabled
↻	Tune Lock	0	tLoc	Automatic Tuning Menu unlocked

Enter select mode by pressing and holding the ↻ button then depressing the △ button. Use the △ or ▽ button to locate the Automatic Tuning Mode (Atun) then press ↻ button to proceed with the operation.

Use the ↻ button to select the Pre-Tune (Ptun) parameter then depress the △ button to turn on the Pre-Tuning operation. You are now performing a Pre-Tuning operation.

Do not change the value of the Self-Tune (Stun) parameter or the Tune Lock (tLoc) parameter when in the Automatic Tuning Mode menu.

Watch the display windows. The Lower Display should read Ptun, and the Upper Display should read On. When the value in the Upper Display changes from On to OFF, the Pre-Tuning operation has successfully completed. Exit the Automatic Tuning Mode by pressing and holding the ↻ button then depress the △ button. Select the new mode using the △ or ▽ button, and enter the desired mode by pressing the ↻ button.

The entire process should take one or two minutes depending on the actual heater element temperature when the Pre-Tune process is invoked.

Always return to the Operator (OPtr) mode to return to normal operation.

Product Information Mode

To select the Product Information Mode (inFo), press and hold the ↻ button then depress the △ button. Once in the select mode, use the △ or ▽ button to locate the Product Information Mode then press ↻ to proceed with the interrogation.

All information in the Product Information Mode menu is read only. As such, the △ and ▽ and "AUTO/MANUAL" buttons serve no purpose when operating within this menu. Note that display values in the chart below that show a question mark (?) are read only values that vary from unit to unit.

Action	Parameter	Upper Display	Lower Display	Description
↻	Input Type	Uni	In_1	Input 1 is a universal type input
↻	Option 1 Module Type	SSr	oPn1	Output 1 module = + 10 to 12 VDC for driving a solid state relay
↻	Option 2 Module Type	rLy	oPn2	Output 2 module = relay contact
↻	Option 3 Module Type	rLy	oPn3	Output 2 module = relay contact
↻	Auxiliary Module Type	nonE	oPnA	No auxiliary module used
↻	Firmware Type	?	FW	Value displayed is firmware type
↻	Firmware Issue	?	ISS	Value displayed is firmware issue
↻	Product Revision Level	?	PrL	Value displayed is product revision level
↻	Date of Manufacture	?	dOM	Manufacturing date code (mmyy)
↻	Serial Number 1	?	Sn1	First four digits of serial number
↻	Serial Number 2	?	Sn2	Middle four digits of serial number
↻	Serial Number 2	?	Sn2	Last four digits of serial number

8 SPARE PARTS LIST

Part Number	Item	Description
509082-000		Replacement Wirebelt
D33009-000		Three Position Splice Clip Set
575938-000	1MTRCON	SCR Motor Controller Assy, 120V, Model KBMM w/ 0.25 Ohm Resistor, Assembled
C35538-000		Upper Heater Element, IR, 15.25"x 8.0", 1500 W, 240 VAC, w/ Type K T/C
028380-000		Lower Heater Element, IR, 15.25"x 8.0", 1500 W, 240 VAC
846002-000	1TEMPCON	Dynapar Temperature Controller, Programmed
874606-000		Replacement Motor Brush Set - Model 105 Tunnel Oven
832785-000	CRM	Relay, 4PDT, 10A, 220VAC Contacts, 120 VAC 50/60Hz Coil, VDE Approved
882465-000	1CR	Relay, DPST, 25A, 220VAC Contacts, 110 VAC 50/60Hz Coil, VDE Approved
498666-000	3CR	Relay, Super Sensitive, SPDT, 2A, 115VAC Contacts, 5 VDC Coil
353155-000	2CR,CRF	Relay, DPDT, 10A, 220VAC Contacts, 120 VAC 50/60Hz Coil, VDE Approved
050684-000	4FAN	Fan, Ball Bearing, 88/106 CFM, 120VAC 50/60 Hz, 4.69 x 4.69 x 1.5"
243722-000	1-3FAN	Fan, Ball Bearing, 31 CFM, 120VAC, 3.62 x 3.62 x 0.98", with 12" leads
241900-000		Gearmotor, 1/12 HP, 130VDC, 0.7A
211185-000	4,6,7,10LT	Ind. Light, 125 VAC Neon, Red, 0.5" Rnd Snap In Panel Mnt, 0.250 Tabs
875571-000	2,5,8LT	Ind. Light, 125 VAC Neon, Amber, 0.5" Rnd Snap In Panel Mnt, 0.250 Tabs
684893-000	3,9LT	Ind. Light, 125 VAC Neon, Clear, 0.5" Rnd Snap In Panel Mnt, 0.250 Tabs
D13099-000	1CB	Circuit Breaker, 2 Pole, 15A, 250VAC, 50/60 Hz, UL, CSA, VDE Approved
999764-000	1TSW	Switch, Temperature, NC, Open @ 225° F +/- 5°, Close @ 205° F +/- 5°, Horizontal Tabs
858515-000	2FU	Fuse, IEC 5x20mm, Low Breaking, Time Delay, 250V, 1A
Contact TE	1FU	Fuse, IEC 5x20mm, Low Breaking, Time Delay, 250V, 1.6A
514357-000	1POT	Digital Potentiometer, 3 Digit, 5K, 2 Watt, 0.1%
812785-000	1TMR	Timer, Delay on Break, 20 Minute Delay Time, 1 A, 120 VAC 50/60 Hz
641271-000	1SSR	Solid State Relay, 24-330VAC, 50A Output, 4-20VDC Input, w/ Safety Cover

9 ELECTRICAL SCHEMATIC

TO 208-240V~50/60 HZ

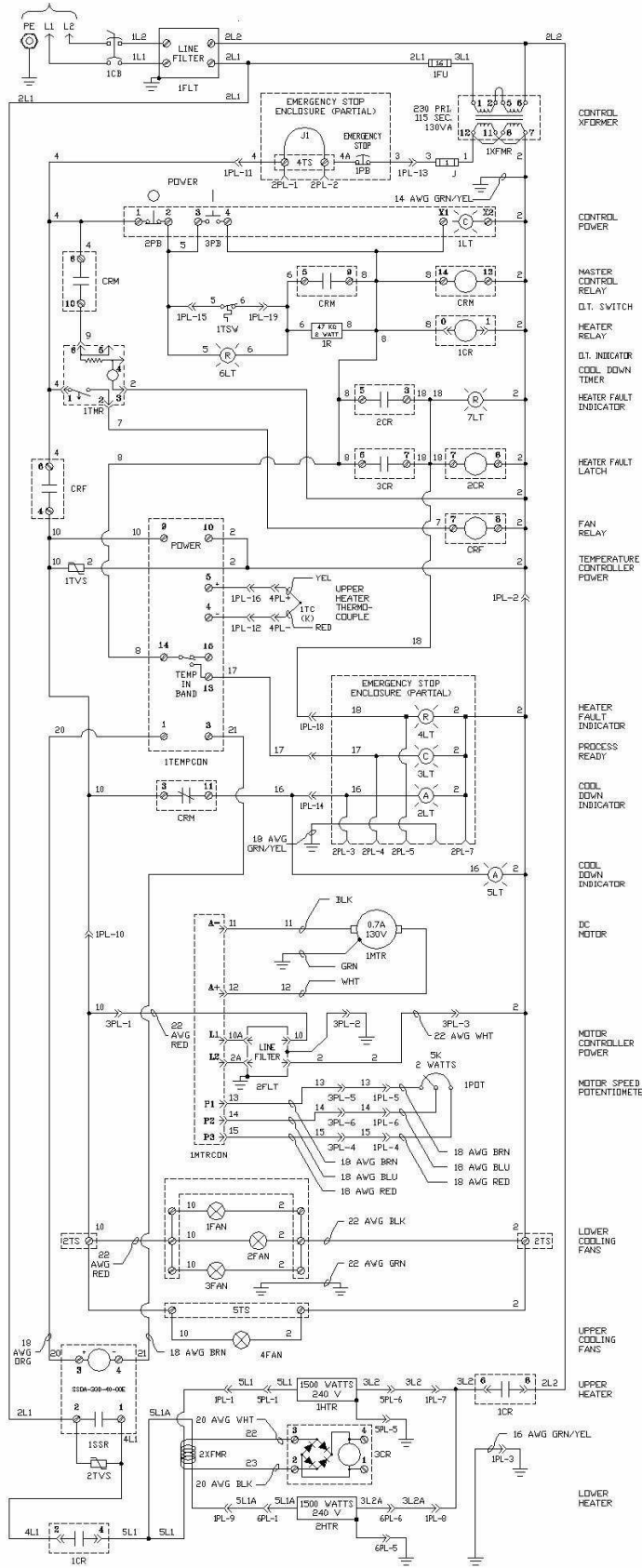

- NOTES:
1. ALL INDIVIDUAL MAINS CONDUCTORS ARE 14 AWG OR LARGER AND BLACK IN COLOR UNLESS OTHERWISE NOTED.
 2. THE 19 CONDUCTOR UMBILICAL CORD USES 18 AWG CONDUCTORS CONNECTED THROUGH 1PL. BELOW ARE THE CIRCUIT AND PIN NUMBER ASSIGNMENTS ACCORDING TO COLOR CODE:

CIRC #	PIN #	COLOR CODE
5L1	1	RED
2	2	WHITE
GROUND	3	GREEN
15	4	RED/WHITE
13	5	GREEN/WHITE
14	6	BLUE/WHITE
3L2	7	BLACK/RED
3L2A	8	BLACK/WHITE
5L1A	9	BLACK
10	10	WHITE/BLACK
4	11	WHITE/RED
TC-	12	ORANGE/RED
3	13	BLUE/BLACK
16	14	ORANGE/BLACK
5	15	BLUE
TC+	16	ORANGE
17	17	GREEN/BLACK
18	18	RED/BLACK
6	19	BLUE/RED

3. ALL UNGROUNDED SECONDARY CONDUCTORS ARE 18 AWG OR LARGER AND RED IN COLOR UNLESS OTHERWISE NOTED.
4. ALL GROUNDED SECONDARY CONDUCTORS (2 CIRCUIT) ARE 18 AWG OR LARGER AND WHITE IN COLOR UNLESS OTHERWISE NOTED.
5. ALL PROTECTIVE EARTH (GROUND) CONDUCTORS ARE 14 AWG GRN WITH YEL STRIPE OR LARGER UNLESS OTHERWISE NOTED.
6. SPARE PLUG PIN LOCATIONS: 5PL-2, 5PL-3, 5PL-4, 5PL-7, 6PL-2, 6PL-3, 6PL-4, 6PL-7
7. REMOVE JUMPER J1 WHEN USING REMOTE EMERGENCY STOP.
8. UNUSED CIRCUIT NUMBERS: 19

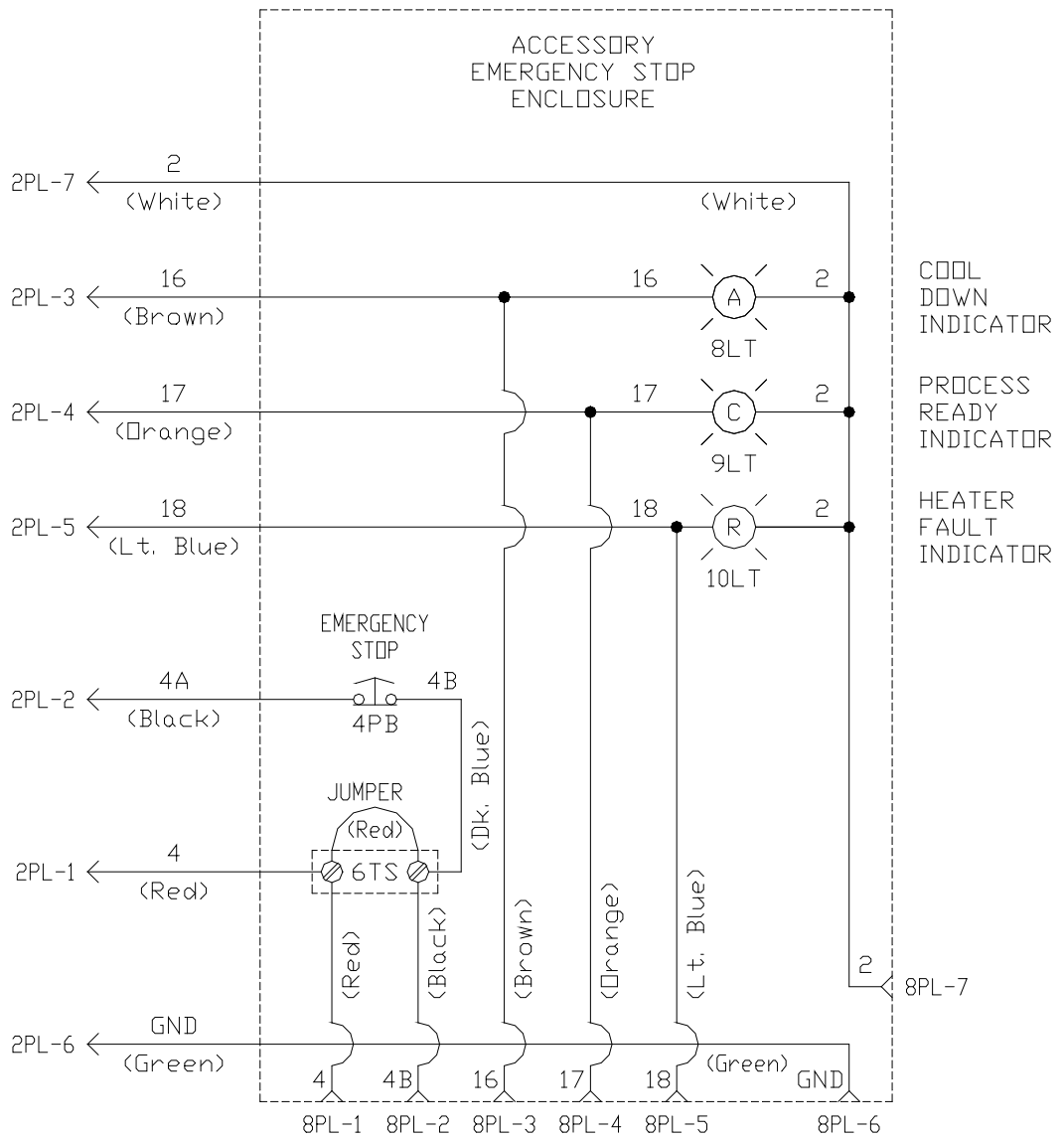

NOTES:

1. ALL WIRING IS CONSTRUCTED FROM 22 AWG OR LARGER CONDUCTORS.
2. TO DAISY CHAIN MULTIPLE ACCESSORY EMERGENCY STOP ENCLOSURES, REMOVE ALL JUMPERS ON TERMINAL STRIP (TS) EXCEPT THE JUMPER IN THE LAST ENCLOSURE OF THE DAISY CHAIN.

10 Customer Support

EMEA Service Hotline

Please contact us for all service enquiries or technical support:

Monday - Thursday 08:00 - 16:00
Friday 08:00 - 14:00
Tel. +49 (0) 6151 607 -1518
www FieldServiceEMEA@te.com

TE Connectivity Germany GmbH
c/o Schenck Technologie- und Industriepark GmbH
Landwehrstr. 55/Gebäude 83
D-64293 Darmstadt
Germany

Additional information and contacts can also be found on the WEB.

Visit us at : <http://tooling.te.com/europe>

Our EMEA Service Hotline supervises and provides the following services:

- Customer service technicians for:
 - Commissioning
 - Preventive maintenance
 - Repair
 - Certification of hand crimping tools
 - Activities based on service contracts
- Customer training for:
 - Operation, maintenance and repair of TE processing equipment
 - TE connection technology including crimping techniques, IDC termination, etc.
- Support in identifying spare parts requirements
- Provision of technical documentation for TE processing equipment

To help us help you as quickly as possible with any questions you may have regarding TE processing equipment, please have the following data available when contacting us:

- Machine description
- TE part number
- Serial number
- Commissioning date/year of manufacture

To avoid unnecessary delays

- for spare parts orders in general and questions regarding prices and delivery times, please contact your local TE sales specialist or distributor, direct.
- for all technical enquiries relating to TE connectors, please contact our Product Information Centre at www.te.com/support-center

Please note that our EMEA Service Hotline staff speak German and English.

TE Connectivity Germany GmbH
a TE Connectivity Ltd. Company
Ampèrestr. 12-14
64625 Bensheim / Germany
Tel. +49-6251-133-0
Fax +49-6251-133-1600

www.te.com

TE Connectivity Germany GmbH certified
acc. ISO 14001 and ISO/TS 16949:2002

© 2012 TE Connectivity Germany GmbH, a TE Connectivity Ltd. company. All rights reserved.

AMP, Raychem, TE Connectivity and TE connectivity (logo) are trademarks.
Other products, logos and company names mentioned herein may be trademarks of their respective owners.

412-94301 / 22-05-06

