

Low $V_{CE(sat)}$ NPN Transistors, 60 V, 1 A

NSS60101DMR6

ON Semiconductor's e²PowerEdge family of low $V_{CE(sat)}$ transistors are miniature surface mount devices featuring ultra low saturation voltage ($V_{CE(sat)}$) and high current gain capability. These are designed for use in low voltage, high speed switching applications where affordable efficient energy control is important.

Typical applications are DC-DC converters and LED lighting, power management...etc. In the automotive industry they can be used in air bag deployment and in the instrument cluster. The high current gain allows e²PowerEdge devices to be driven directly from PMU's control outputs, and the Linear Gain (Beta) makes them ideal components in analog amplifiers.

Features

- NSV Prefix for Automotive and Other Applications Requiring Unique Site and Control Change Requirements; AEC-Q101 Qualified and PPAP Capable
- These Devices are Pb-Free, Halogen Free/BFR Free and are RoHS Compliant

MAXIMUM RATINGS ($T_A = 25^\circ\text{C}$)

Rating	Symbol	Max	Unit
Collector-Emitter Voltage	V_{CEO}	60	Vdc
Collector-Base Voltage	V_{CBO}	80	Vdc
Emitter-Base Voltage	V_{EBO}	6	Vdc
Collector Current - Continuous	I_C	1	A
Collector Current - Peak	I_{CM}	2	A

Stresses exceeding those listed in the Maximum Ratings table may damage the device. If any of these limits are exceeded, device functionality should not be assumed, damage may occur and reliability may be affected.

THERMAL CHARACTERISTICS

Characteristic	Symbol	Max	Unit
Thermal Resistance Junction-to-Ambient (Notes 1 and 2)	$R_{\theta JA}$	234	$^\circ\text{C}/\text{W}$
Total Power Dissipation per Package @ $T_A = 25^\circ\text{C}$ (Note 2)	P_D	0.53	W
Thermal Resistance Junction-to-Ambient (Note 3)	$R_{\theta JA}$	300	$^\circ\text{C}/\text{W}$
Power Dissipation per Transistor @ $T_A = 25^\circ\text{C}$ (Note 3)	P_D	0.40	W
Junction and Storage Temperature Range	T_J, T_{stg}	-55 to +150	$^\circ\text{C}$

1. Per JESD51-7 with 100 mm² pad area and 2 oz. Cu (Dual Operation).
2. P_D per Transistor when both are turned on is one half of Total P_D or 0.53 Watts.
3. Per JESD51-7 with 100 mm² pad area and 2 oz. Cu (Single-Operation).



ON Semiconductor®

www.onsemi.com

60 Volt, 1 Amp
NPN Low $V_{CE(sat)}$ Transistors



SC-74
CASE 318F

MARKING DIAGRAM

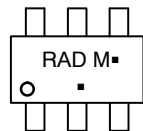

RAD = Specific Device Code
M = Date Code
▪ = Pb-Free Package

(Note: Microdot may be in either location)

PIN CONNECTIONS

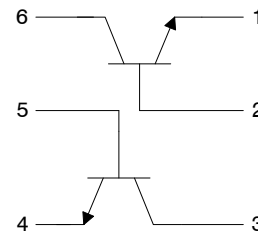
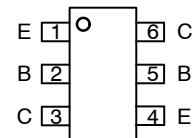

ORDERING INFORMATION

Device	Package	Shipping†
NSS60101DMR6T1G	SC-74 (Pb-Free)	3000/Tape & Reel
NSS60101DMR6T2G		
NSV60101DMR6T1G		
NSV60101DMR6T2G		

†For information on tape and reel specifications, including part orientation and tape sizes, please refer to our Tape and Reel Packaging Specification Brochure, BRD8011/D.

NSS60101DMR6

Table 1. ELECTRICAL CHARACTERISTICS ($T_A = 25^\circ\text{C}$ unless otherwise noted)

Characteristic	Symbol	Min	Typ	Max	Unit
OFF CHARACTERISTICS					
Collector–Emitter Breakdown Voltage ($I_C = 10\text{ mA}$, $I_B = 0$)	$V_{(BR)CEO}$	60			V
Collector–Base Breakdown Voltage ($I_C = 0.1\text{ mA}$, $I_E = 0$)	$V_{(BR)CBO}$	80			V
Emitter–Base Breakdown Voltage ($I_E = 0.1\text{ mA}$, $I_C = 0$)	$V_{(BR)EBO}$	6			V
Collector Cutoff Current ($V_{CB} = 60\text{ V}$, $I_E = 0$)	I_{CBO}			100	nA
Emitter Cutoff Current ($V_{BE} = 5.0\text{ V}$)	I_{EBO}			100	nA

ON CHARACTERISTICS

DC Current Gain (Note 4) ($I_C = 100\text{ mA}$, $V_{CE} = 2\text{ V}$) ($I_C = 500\text{ mA}$, $V_{CE} = 2\text{ V}$) ($I_C = 1\text{ A}$, $V_{CE} = 2\text{ V}$) ($I_C = 1\text{ mA}$, $V_{CE} = 5\text{ V}$) ($I_C = 100\text{ mA}$, $V_{CE} = 5\text{ V}$) ($I_C = 500\text{ mA}$, $V_{CE} = 5\text{ V}$) ($I_C = 1\text{ A}$, $V_{CE} = 5\text{ V}$)	h_{FE}	200 150 70 250 250 200 100	320 290 110 335 335 310 295		
Collector–Emitter Saturation Voltage (Note 4) ($I_C = 100\text{ mA}$, $I_B = 1\text{ mA}$) ($I_C = 500\text{ mA}$, $I_B = 50\text{ mA}$) ($I_C = 1\text{ A}$, $I_B = 50\text{ mA}$) ($I_C = 1\text{ A}$, $I_B = 100\text{ mA}$)	$V_{CE(sat)}$		0.080 0.078 0.170 0.143	0.200 0.150 0.250 0.200	V
Base–Emitter Saturation Voltage (Note 4) ($I_C = 500\text{ mA}$, $I_B = 50\text{ mA}$) ($I_C = 1\text{ A}$, $I_B = 50\text{ mA}$) ($I_C = 1\text{ A}$, $I_B = 100\text{ mA}$)	$V_{BE(sat)}$		0.87 0.91 0.94	1.50 1.50 1.60	V
Base–Emitter Turn–on Voltage (Note 4) ($I_C = 1\text{ mA}$, $V_{CE} = 1\text{ V}$) ($I_C = 500\text{ mA}$, $V_{CE} = 2\text{ V}$)	$V_{BE(on)}$	0.27	0.57 0.76	0.90	V

DYNAMIC CHARACTERISTICS

Input Capacitance ($V_{EB} = 1\text{ V}$, $f = 1.0\text{ MHz}$)	C_{ibo}		100		pF
Output Capacitance ($V_{CB} = 10\text{ V}$, $f = 1.0\text{ MHz}$)	C_{obo}		8.0		pF
Cutoff Frequency ($I_C = 50\text{ mA}$, $V_{CE} = 2.0\text{ V}$, $f = 100\text{ MHz}$)	f_T		200		MHz

SWITCHING TIMES

Delay Time ($V_{CC} = 10\text{ V}$, $I_C = 0.5\text{ A}$, $I_{B1} = 25\text{ mA}$, $I_{B2} = -25\text{ mA}$)	t_d		10		ns
ON Time ($V_{CC} = 10\text{ V}$, $I_C = 0.5\text{ A}$, $I_{B1} = 25\text{ mA}$, $I_{B2} = -25\text{ mA}$)	t_{on}		28		ns
Rise Time ($V_{CC} = 10\text{ V}$, $I_C = 0.5\text{ A}$, $I_{B1} = 25\text{ mA}$, $I_{B2} = -25\text{ mA}$)	t_r		18		ns
Storage Time ($V_{CC} = 10\text{ V}$, $I_C = 0.5\text{ A}$, $I_{B1} = 25\text{ mA}$, $I_{B2} = -25\text{ mA}$)	t_s		622		ns
OFF Time ($V_{CC} = 10\text{ V}$, $I_C = 0.5\text{ A}$, $I_{B1} = 25\text{ mA}$, $I_{B2} = -25\text{ mA}$)	t_{off}		709		ns
Fall Time ($V_{CC} = 10\text{ V}$, $I_C = 0.5\text{ A}$, $I_{B1} = 25\text{ mA}$, $I_{B2} = -25\text{ mA}$)	t_f		87		ns

Product parametric performance is indicated in the Electrical Characteristics for the listed test conditions, unless otherwise noted. Product performance may not be indicated by the Electrical Characteristics if operated under different conditions.

4. Pulse Condition: Pulse Width = 300 μsec , Duty Cycle $\leq 2\%$.

TYPICAL CHARACTERISTICS

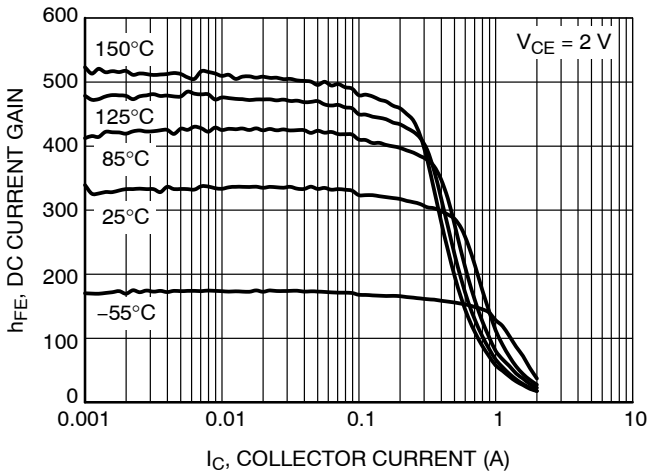

Figure 1. DC Current Gain

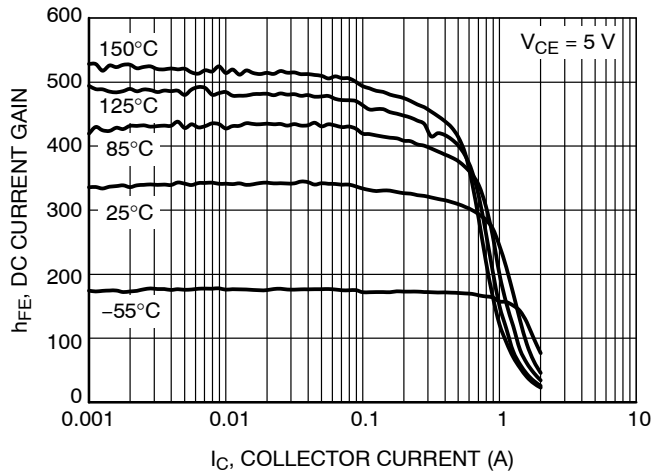

Figure 2. DC Current Gain

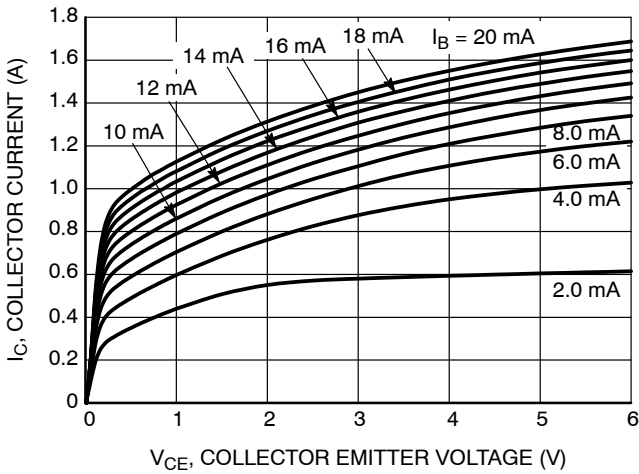

Figure 3. Collector Current as a Function of Collector Emitter Voltage

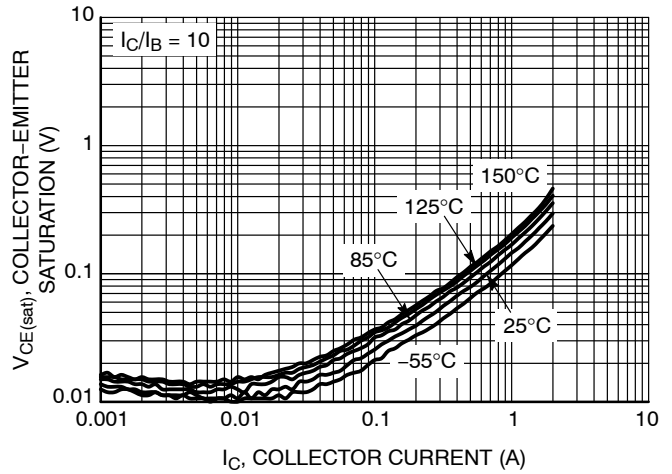

Figure 4. Collector-Emitter Saturation Voltage

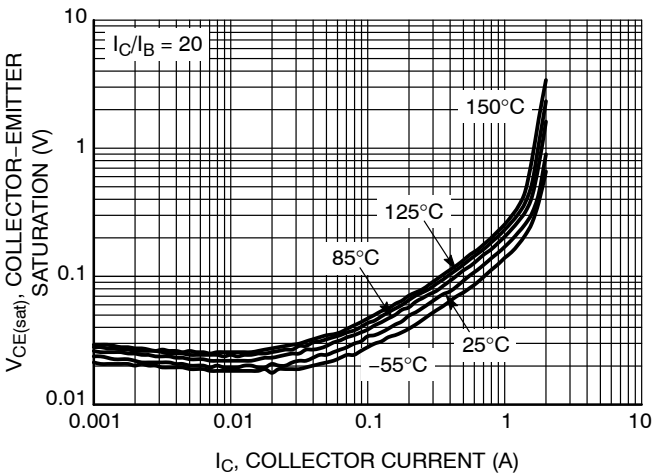

Figure 5. Collector-Emitter Saturation Voltage

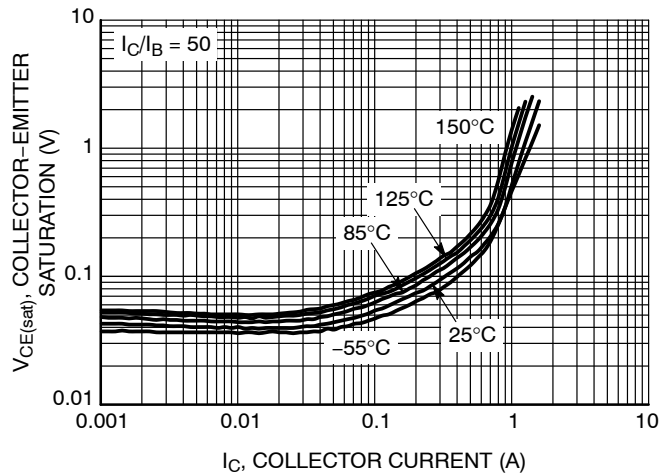

Figure 6. Collector-Emitter Saturation Voltage

TYPICAL CHARACTERISTICS

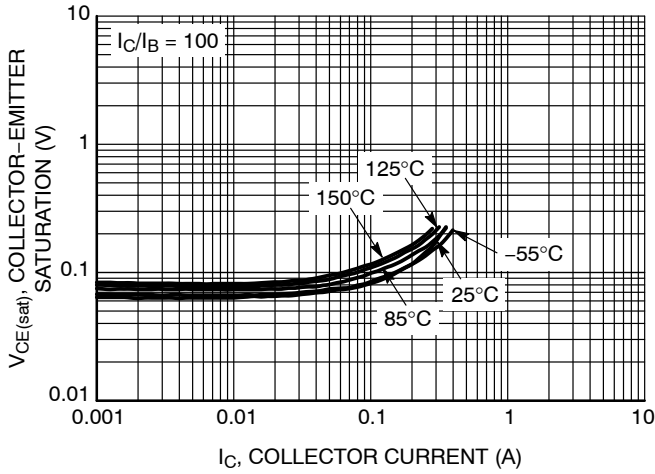

Figure 7. Collector-Emitter Saturation Voltage

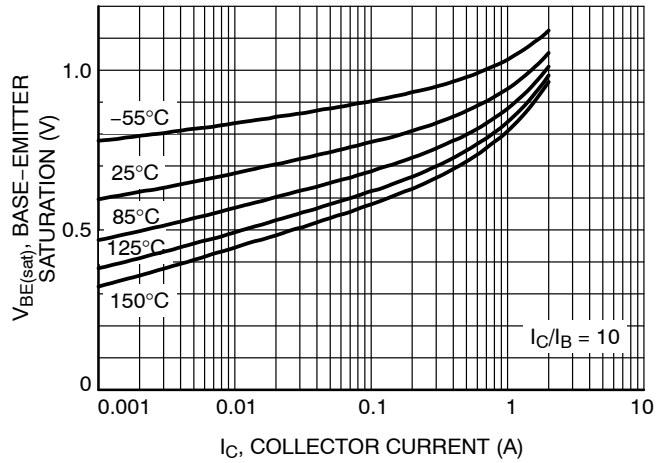

Figure 8. Base-Emitter Saturation Voltage

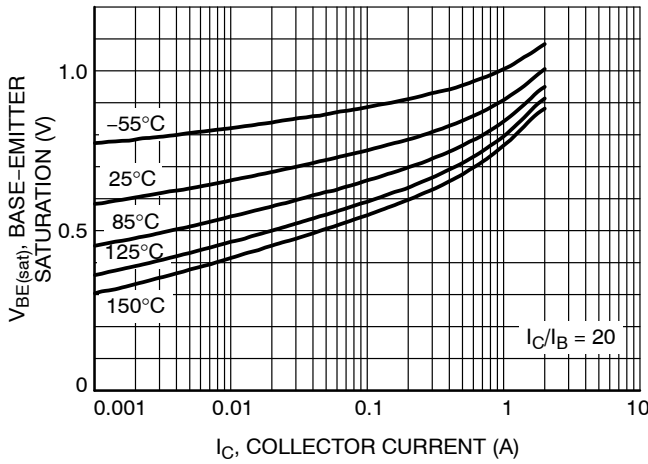

Figure 9. Base-Emitter Saturation Voltage

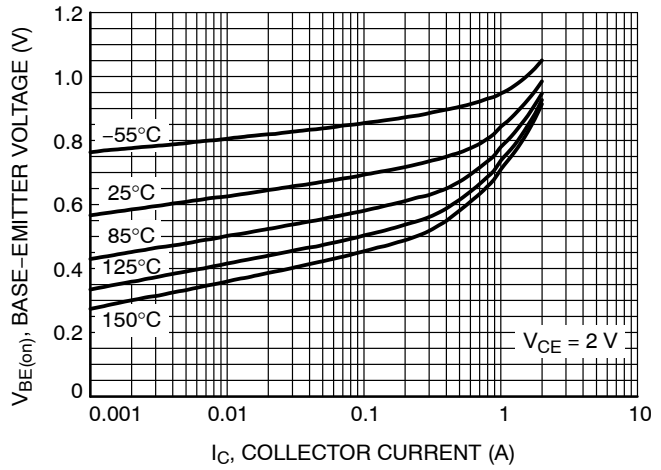

Figure 10. Base-Emitter "ON" Voltage

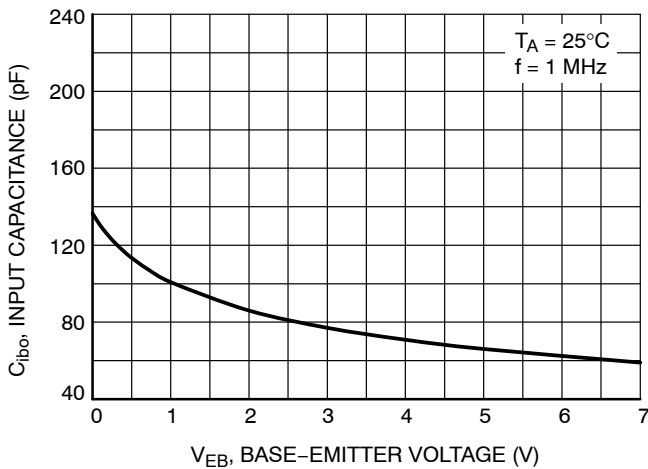

Figure 11. Input Capacitance

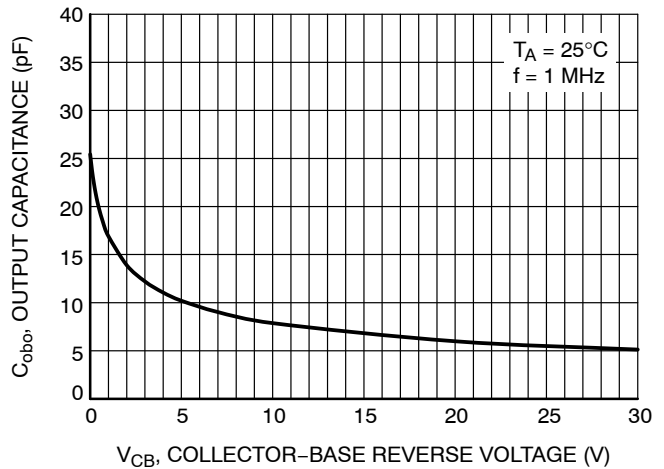

Figure 12. Output Capacitance

TYPICAL CHARACTERISTICS

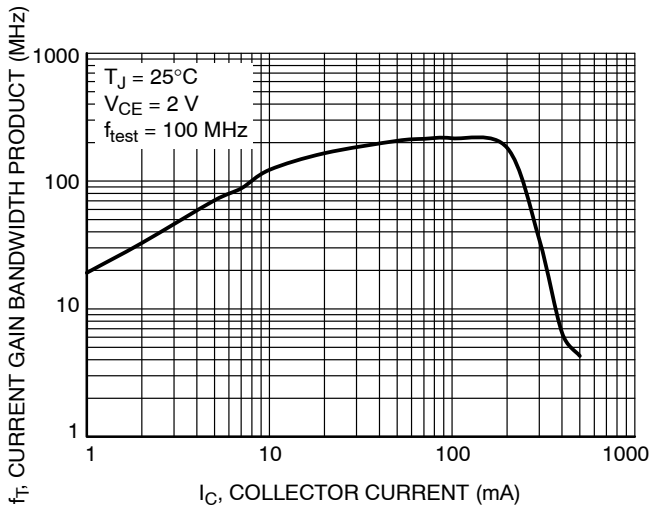

Figure 13. f_T , Current Gain Bandwidth Product

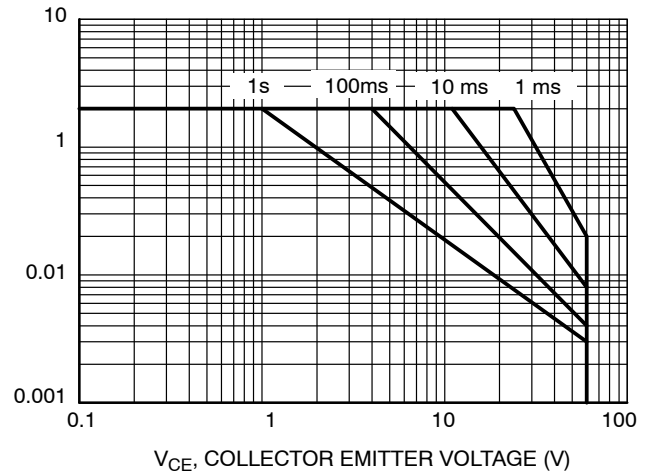

Figure 16. Safe Operating Area ($T_A = 25^\circ\text{C}$)

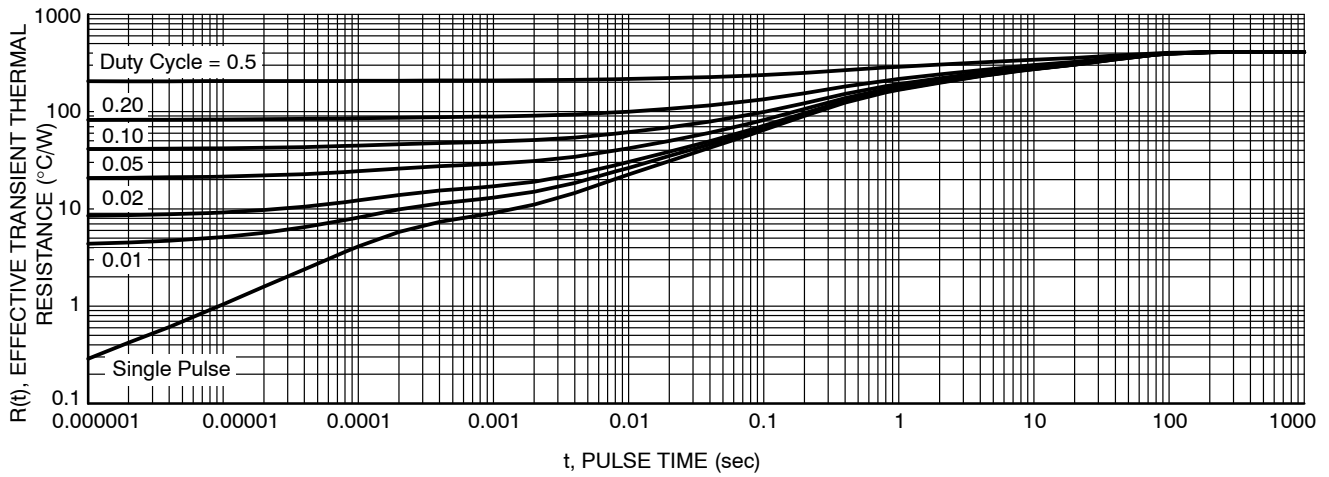

Figure 14. Thermal Resistance by Transistor

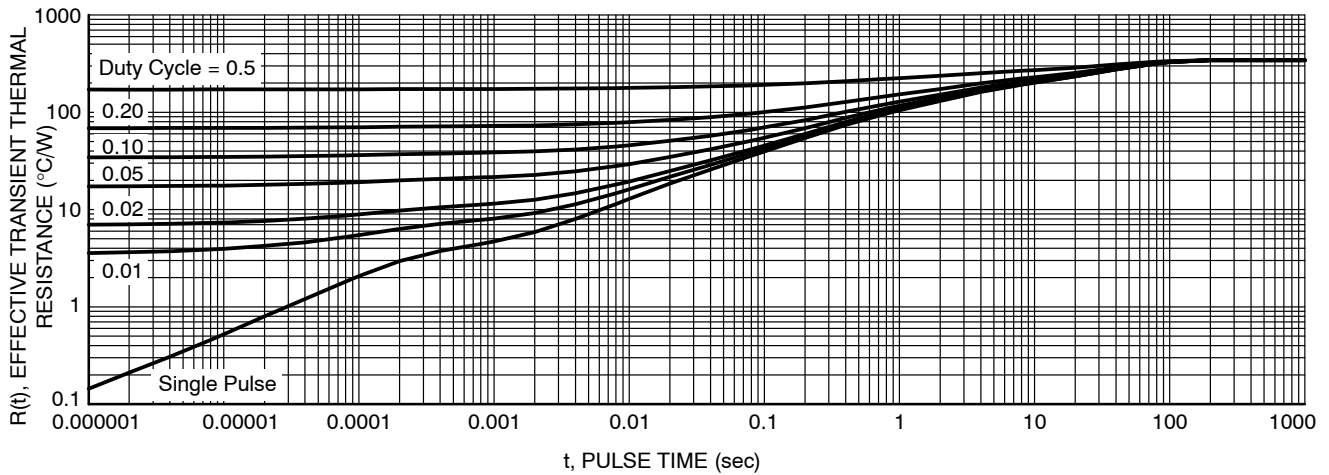

Figure 15. Thermal Resistance for Both Transistors

MECHANICAL CASE OUTLINE

PACKAGE DIMENSIONS

ON Semiconductor®



SC-74

CASE 318F-05

ISSUE N

DATE 08 JUN 2012

SCALE 2:1

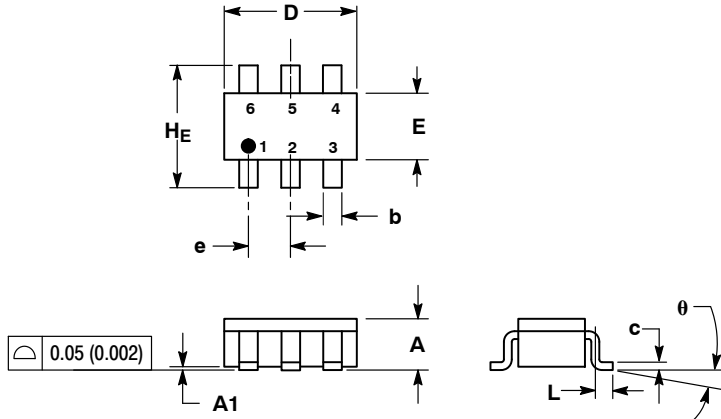

NOTES:

1. DIMENSIONING AND TOLERANCING PER ANSI Y14.5M, 1982.
2. CONTROLLING DIMENSION: INCH.
3. MAXIMUM LEAD THICKNESS INCLUDES LEAD FINISH THICKNESS. MINIMUM LEAD THICKNESS IS THE MINIMUM THICKNESS OF BASE MATERIAL.
4. 318F-01, -02, -03, -04 OBSOLETE. NEW STANDARD 318F-05.

DIM	MILLIMETERS			INCHES		
	MIN	NOM	MAX	MIN	NOM	MAX
A	0.90	1.00	1.10	0.035	0.039	0.043
A1	0.01	0.06	0.10	0.001	0.002	0.004
b	0.25	0.37	0.50	0.010	0.015	0.020
c	0.10	0.18	0.26	0.004	0.007	0.010
D	2.90	3.00	3.10	0.114	0.118	0.122
E	1.30	1.50	1.70	0.051	0.059	0.067
e	0.85	0.95	1.05	0.034	0.037	0.041
L	0.20	0.40	0.60	0.008	0.016	0.024
HE	2.50	2.75	3.00	0.099	0.108	0.118
θ						

SOLDERING FOOTPRINT*

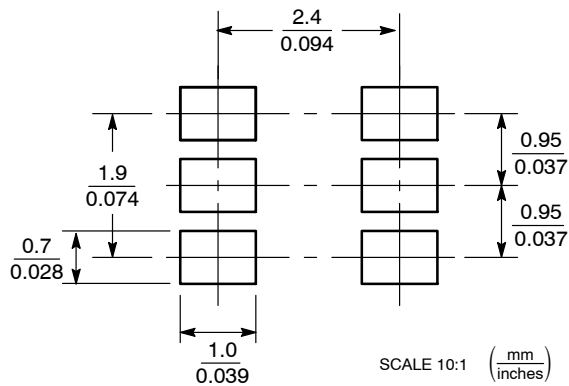

GENERIC MARKING DIAGRAM*

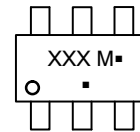

- XXX = Specific Device Code
- M = Date Code
- = Pb-Free Package

(Note: Microdot may be in either location)

*This information is generic. Please refer to device data sheet for actual part marking. Pb-Free indicator, "G" or microdot "▪", may or may not be present.

*For additional information on our Pb-Free strategy and soldering details, please download the ON Semiconductor Soldering and Mounting Techniques Reference Manual, SOLDERRM/D.

STYLE 1:

- PIN 1. CATHODE
- 2. ANODE
- 3. CATHODE
- 4. CATHODE
- 5. ANODE
- 6. CATHODE

STYLE 2:

- PIN 1. NO CONNECTION
- 2. COLLECTOR
- 3. EMITTER
- 4. NO CONNECTION
- 5. COLLECTOR
- 6. BASE

STYLE 3:

- PIN 1. EMITTER 1
- 2. BASE 1
- 3. COLLECTOR 2
- 4. EMITTER 2
- 5. BASE 2
- 6. COLLECTOR 1

STYLE 4:

- PIN 1. COLLECTOR 2
- 2. EMITTER 1/EMITTER 2
- 3. COLLECTOR 1
- 4. EMITTER 3
- 5. BASE 1/BASE 2/COLLECTOR 3
- 6. BASE 3

STYLE 5:

- PIN 1. CHANNEL 1
- 2. ANODE
- 3. CHANNEL 2
- 4. CHANNEL 3
- 5. CATHODE
- 6. CHANNEL 4

STYLE 6:

- PIN 1. CATHODE
- 2. ANODE
- 3. CATHODE
- 4. CATHODE
- 5. CATHODE
- 6. CATHODE

STYLE 7:

- PIN 1. SOURCE 1
- 2. GATE 1
- 3. DRAIN 2
- 4. SOURCE 2
- 5. GATE 2
- 6. DRAIN 1

STYLE 8:

- PIN 1. EMITTER 1
- 2. BASE 2
- 3. COLLECTOR 2
- 4. EMITTER 2
- 5. BASE 1
- 6. COLLECTOR 1

STYLE 9:

- PIN 1. EMITTER 2
- 2. BASE 2
- 3. COLLECTOR 1
- 4. EMITTER 1
- 5. BASE 1
- 6. COLLECTOR 2

STYLE 10:

- PIN 1. ANODE/CATHODE
- 2. BASE
- 3. EMITTER
- 4. COLLECTOR
- 5. ANODE
- 6. CATHODE

STYLE 11:

- PIN 1. EMITTER
- 2. BASE
- 3. ANODE/CATHODE
- 4. ANODE
- 5. CATHODE
- 6. COLLECTOR

DOCUMENT NUMBER:	98ASB42973B	Electronic versions are uncontrolled except when accessed directly from the Document Repository. Printed versions are uncontrolled except when stamped "CONTROLLED COPY" in red.
DESCRIPTION:	SC-74	PAGE 1 OF 1

ON Semiconductor and are trademarks of Semiconductor Components Industries, LLC dba ON Semiconductor or its subsidiaries in the United States and/or other countries. ON Semiconductor reserves the right to make changes without further notice to any products herein. ON Semiconductor makes no warranty, representation or guarantee regarding the suitability of its products for any particular purpose, nor does ON Semiconductor assume any liability arising out of the application or use of any product or circuit, and specifically disclaims any and all liability, including without limitation special, consequential or incidental damages. ON Semiconductor does not convey any license under its patent rights nor the rights of others.

onsemi, **Onsemi**, and other names, marks, and brands are registered and/or common law trademarks of Semiconductor Components Industries, LLC dba "**onsemi**" or its affiliates and/or subsidiaries in the United States and/or other countries. **onsemi** owns the rights to a number of patents, trademarks, copyrights, trade secrets, and other intellectual property. A listing of **onsemi**'s product/patent coverage may be accessed at www.onsemi.com/site/pdf/Patent-Marking.pdf. **onsemi** reserves the right to make changes at any time to any products or information herein, without notice. The information herein is provided "as-is" and **onsemi** makes no warranty, representation or guarantee regarding the accuracy of the information, product features, availability, functionality, or suitability of its products for any particular purpose, nor does **onsemi** assume any liability arising out of the application or use of any product or circuit, and specifically disclaims any and all liability, including without limitation special, consequential or incidental damages. Buyer is responsible for its products and applications using **onsemi** products, including compliance with all laws, regulations and safety requirements or standards, regardless of any support or applications information provided by **onsemi**. "Typical" parameters which may be provided in **onsemi** data sheets and/or specifications can and do vary in different applications and actual performance may vary over time. All operating parameters, including "Typicals" must be validated for each customer application by customer's technical experts. **onsemi** does not convey any license under any of its intellectual property rights nor the rights of others. **onsemi** products are not designed, intended, or authorized for use as a critical component in life support systems or any FDA Class 3 medical devices or medical devices with a same or similar classification in a foreign jurisdiction or any devices intended for implantation in the human body. Should Buyer purchase or use **onsemi** products for any such unintended or unauthorized application, Buyer shall indemnify and hold **onsemi** and its officers, employees, subsidiaries, affiliates, and distributors harmless against all claims, costs, damages, and expenses, and reasonable attorney fees arising out of, directly or indirectly, any claim of personal injury or death associated with such unintended or unauthorized use, even if such claim alleges that **onsemi** was negligent regarding the design or manufacture of the part. **onsemi** is an Equal Opportunity/Affirmative Action Employer. This literature is subject to all applicable copyright laws and is not for resale in any manner.

PUBLICATION ORDERING INFORMATION

LITERATURE FULFILLMENT:

Email Requests to: orderlit@onsemi.com

onsemi Website: www.onsemi.com

TECHNICAL SUPPORT

North American Technical Support:

Voice Mail: 1 800-282-9855 Toll Free USA/Canada

Phone: 011 421 33 790 2910

Europe, Middle East and Africa Technical Support:

Phone: 00421 33 790 2910

For additional information, please contact your local Sales Representative