

0.8mm Height Flat Top Phototransistor

PT19-21C/L41/TR8

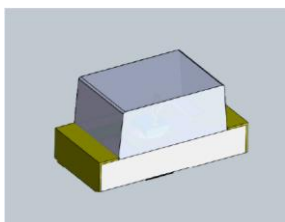

Features

- Fast response time
- High photo sensitivity
- Small junction capacitance
- Pb free
- The product itself will remain within RoHS compliant version
- Compliance with EU REACH

Descriptions

- PT19-21C/L41/TR8 is a phototransistor in miniature SMD package which is molded in a water clear with flat top view lens. The device is Spectrally matched to visible and infrared emitting diode.

Applications

- Miniature switch
- Counters and sorter
- Position sensor
- Infrared applied system
- Encoder

Device Selection Guide

Part Category	Chip Material	Lens Color
PT	Silicon	Water clear

Package Dimensions

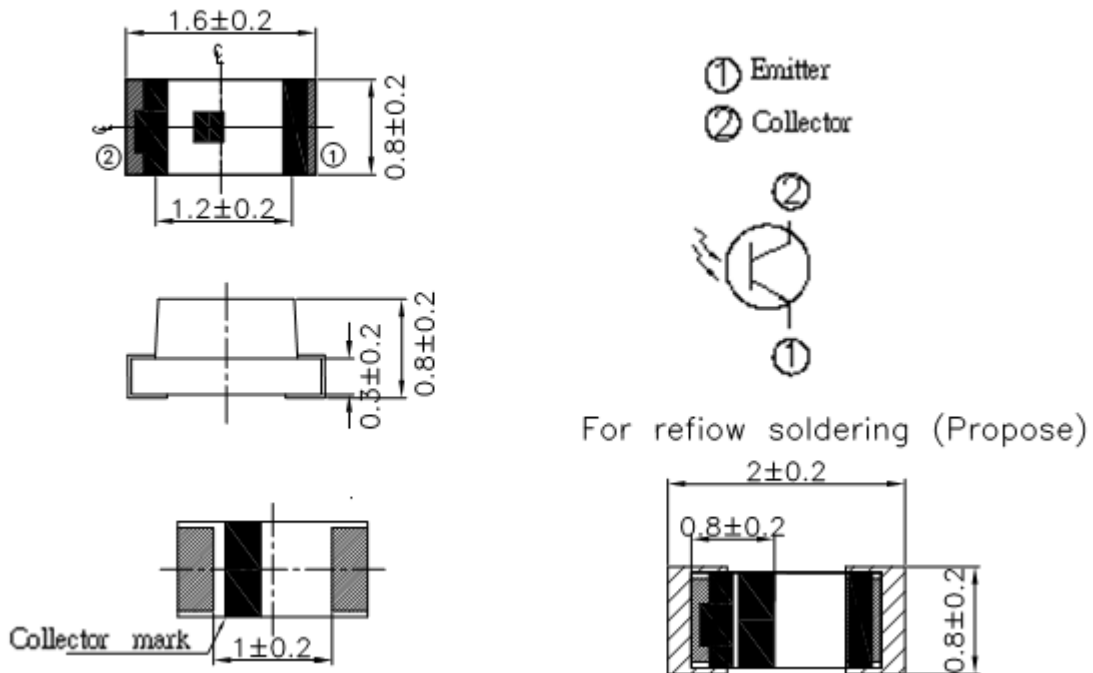

- Notes:**
1. All dimensions are in millimeters
 2. Tolerances unless dimensions ± 0.1 mm
 3. Suggested pad dimension is just for reference only
Please modify the pad dimension based on individual need

Absolute Maximum Ratings (Ta=25°C)

Parameter	Symbol	Rating	Units
Collector-Emitter Voltage	V_{CEO}	30	V
Emitter-Collector-Voltage	V_{ECO}	5	V
Collector Current	I_C	20	mA
Operating Temperature	T_{opr}	-25 ~ +85	°C
Storage Temperature	T_{stg}	-40 ~ +85	°C
Soldering Temperature *1	T_{sol}	260	°C
Power Dissipation at(or below) 25°C Free Air Temperature	P_d	75	mW

Notes: *1:Soldering time \leq 5 seconds.

Electro-Optical Characteristics (Ta=25°C)

Parameter	Symbol	Condition	Min	Typ	Max	Unit
Spectral range of sensitivity	$\lambda_{0.5}$	---	550	---	1050	nm
Wavelength Of Peak Sensitivity	λ_P	---	---	940	---	nm
Collector-Emitter Breakdown Voltage	BV_{CEO}	$I_C=100\mu A$ $E_e=0mW/cm^2$	30	---	---	V
Emitter-Collector Breakdown Voltage	BV_{ECO}	$I_E=100\mu A$ $E_e=0mW/cm^2$	5	---	---	V
Collector-Emitter Saturation Voltage	$V_{CE(sat)}$	$I_C=2mA$ $E_e=1mW/cm^2$	---	---	0.4	V
Collector Dark Current	I_{CEO}	$V_{CE}=20V$ $E_e=0mW/cm^2$	---	---	100	nA
On State Collector Current	$I_{C(ON)}$	$V_{CE}=5V$ $E_e=1mW/cm^2$	0.3	0.6	---	mA

Typical Electro-Optical Characteristics Curves

Fig.1 Spectral Sensitivity

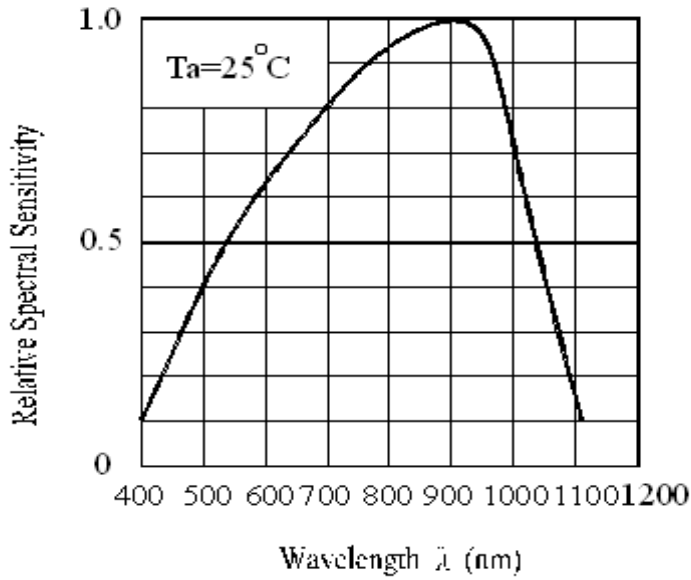

Fig.2 Collector Current vs. Irradiance

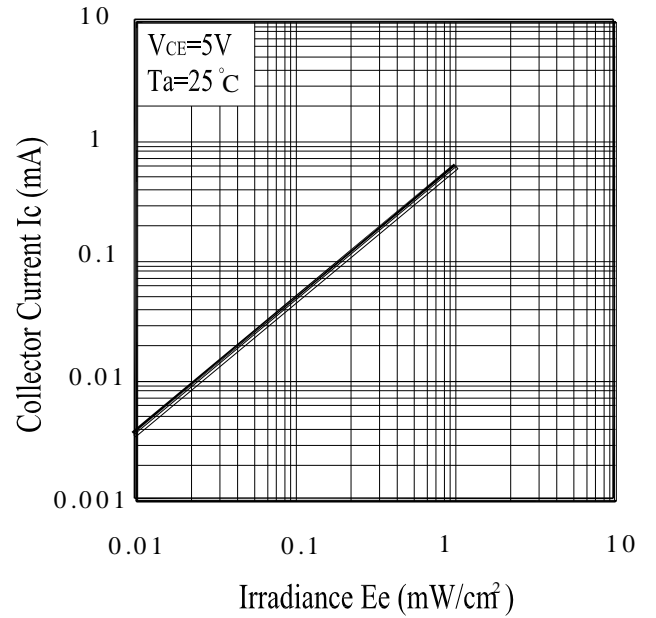
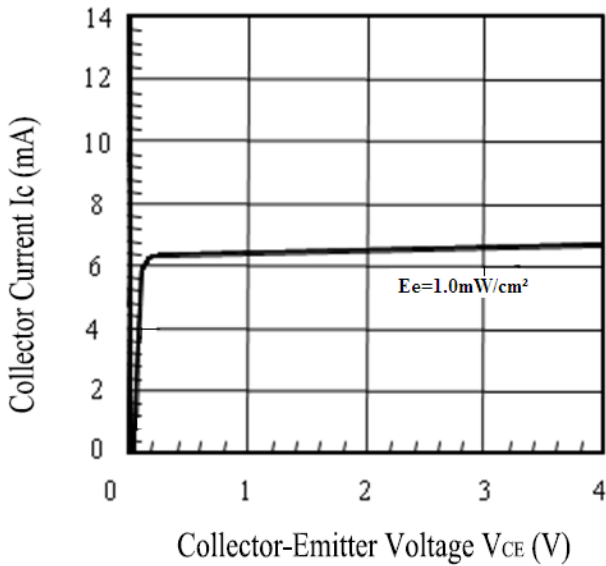

Fig.3 Collector Current vs. Collector-Emitter Voltage



Precautions For Use

1. Over-current-proof

Customer must apply resistors for protection, otherwise slight voltage shift will cause big current change (Burn out will happen).

2. Storage

2.1 Do not open moisture proof bag before the products are ready to use.

2.2 Before opening the package, the Phototransistor should be kept at 10°C~30°C and 90%RH or less.

2.3 The Phototransistor suggested be used within one year.

2.4 After opening the package, the devices must be stored at 10°C~30°C and ≤ 60%RH, and used within 168 hours (floor life). If unused Phototransistor remain, it should be stored in moisture proof packages.

2.5 If the moisture absorbent material (desiccant material) has faded or unopened bag has exceeded the shelf life or devices (out of bag) have exceeded the floor life, baking treatment is required.

2.6 If baking is required, refer to IPC/JEDEC J-STD-033 for bake procedure or recommend the following conditions:

96 hours at 60°C ± 5°C and < 5 % RH (reeled/tubed/loose units)

3. Soldering Condition

3.1 Lead solder temperature profile

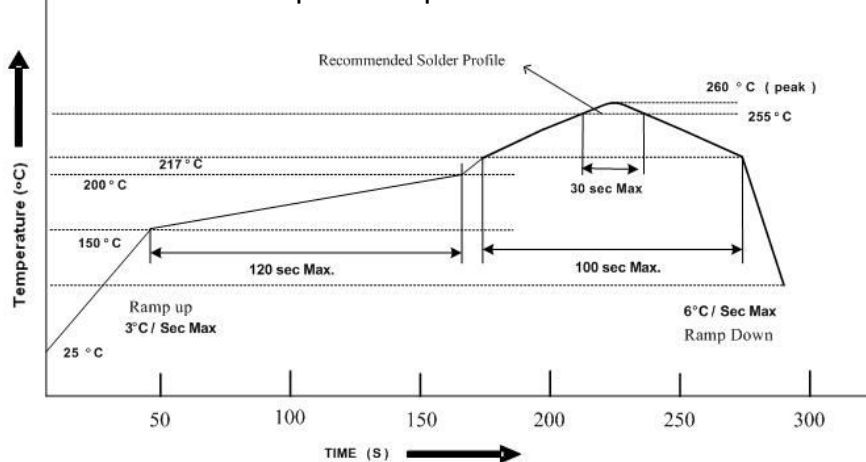

3.2 Reflow soldering should not be done more than two times.

3.3 When soldering, do not put stress on the Phototransistor during heating.

3.4 After soldering, do not warp the circuit board.

4. Soldering Iron







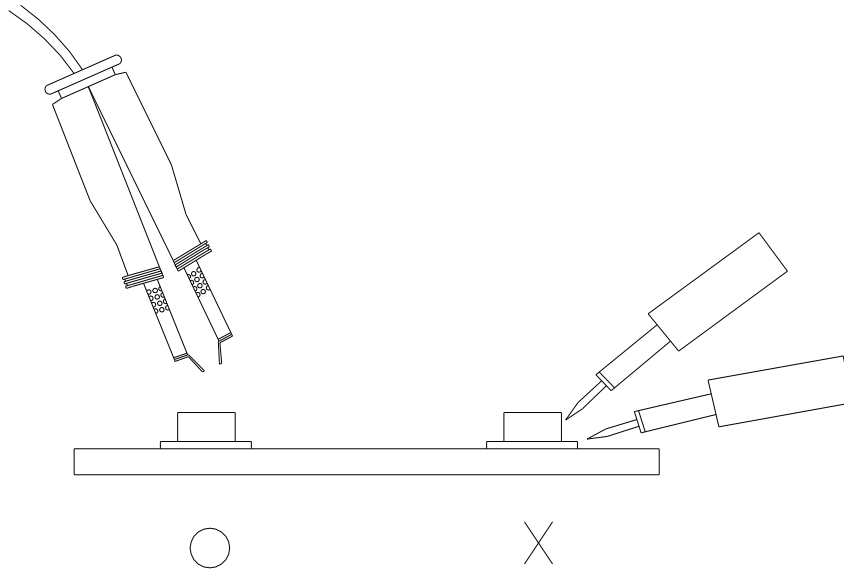

Each terminal is to go to the tip of soldering iron temperature less than 350°C for 3 seconds within once in less than the soldering iron capacity 25W. Leave two seconds and more intervals, and do soldering of each terminal. Be careful because the damage of the product is often started at the time of the hand solder.

5. Repairing

Repair should not be done after the Phototransistor have been soldered. When repairing is unavoidable, a double-head soldering iron should be used (as below figure). It should be confirmed beforehand whether the characteristics of the Phototransistor will or will not be damaged by repairing.



Label Form Specification

RoHS		EVERLIGHT	5
CPN: XXXXXXXXXXXXXXXXXXXX			
			
XXXXXXXXXX-XXXXXXXXXX-XXXXXXXXXX-XXXXXXXXXX-XXXXXX			
P/N: XXXXXXXXXXXX			
			
XXXXXXXXXX-XXXXXXXXXX-XXXXXXXXXX-XXXXXXXXXX-XXXXXX			
LOT NO: Y150716XXX-XXXXXXXXXX-XXXXXXXXXX			
			
QTY: 0123456789 HUE: XXXXXXXXXXXX			
			
CAT: XXXXXXXXXXXX REF: XXXXXXXXXXXX			
			
REFERENCE: BTPYYMDDXXXXX			
			
MSL-X MADE IN XXXXXX			
			

CPN: Customer's Production Number

P/N : Production Number

LOT No: Lot Number

QTY: Packing Quantity

HUE: Peak Wavelength

CAT: Ranks

REF: Reference

MSL-X: MSL Level

Made In: Manufacture place

Notes

- Above specification may be changed without notice. EVERLIGHT will reserve authority on material change for above specification.
- The graphs shown in this datasheet are representing typical data only and do not show guaranteed values.
- When using this product, please observe the absolute maximum ratings and the instructions for use outlined in these specification sheets. EVERLIGHT assumes no responsibility for any damage resulting from use of the product which does not comply with the absolute maximum ratings and the instructions included in these specification sheets.
- These specification sheets include materials protected under copyright of EVERLIGHT. Reproduction in any form is prohibited without the specific consent of EVERLIGHT.
- This product is not intended to be used for military, aircraft, automotive, medical, life sustaining or life saving applications or any other application which can result in human injury or death. Please contact authorized Everlight sales agent for special application request.

EVERLIGHT ELECTRONICS CO., LTD.

Office: No. 6-8, Zhonghua Rd., Shulin Dist.,

New Taipei City 23860, Taiwan

Tel: 886-2-2685-6688

Fax: 886-2685-2699 · 6897

<http://www.everlight.com>