

LC 8 PORT ADAPTER P/N	ADAPTER COLOR	SPLIT SLEEVE MATERIAL
106121-0450	BLUE	CERAMIC
106121-0460	GREEN	
106121-0470	BEIGE	PHOSPHOR BRONZE
106121-0480	AQUA	

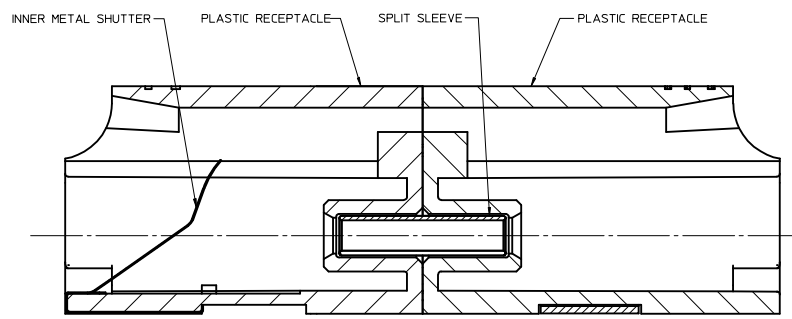

SECTION Z-Z
Scale 10:1

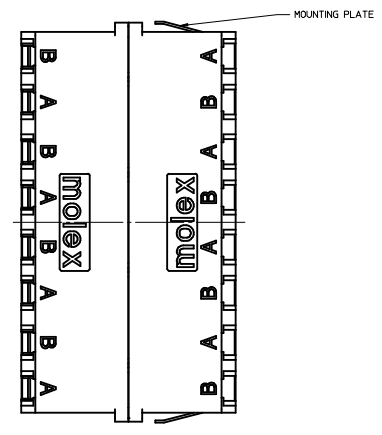
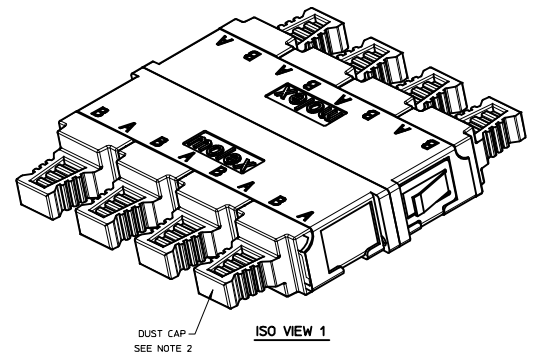
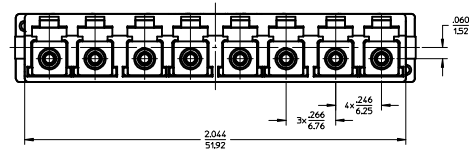
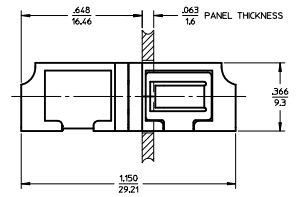
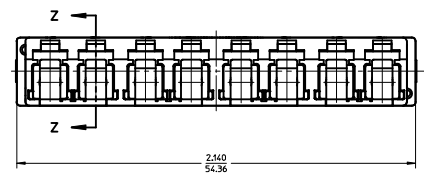

ISO VIEW 1

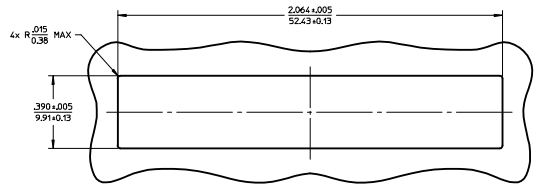

RECOMMENDED
MOUNTING PATTERN

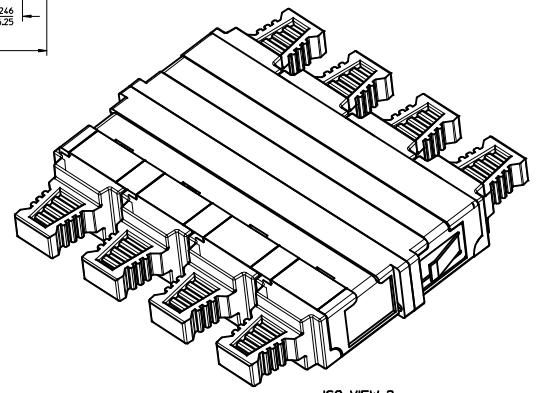

ISO VIEW 2

NOTES:
1. ALL DIMENSIONS ARE FOR REFERENCE.
2. DUST CAPS SHOWN IN ISO VIEWS ONLY.

ENTER DESCRIPTION IEC NO. MF2015-0403 DRAWN BY: YBELNKIY CHKD: WCHEN APPR: WCHEN DATE: 2015/06/16 2015/09/25	QUALITY SYMBOLS	GENERAL TOLERANCES (UNLESS SPECIFIED)	DIMENSION STYLE IN/MM	SCALE 3:1	DESIGN UNITS INCH	THIRD ANGLE PROJECTION	
		4 PLACES ± --- ± --- 3 PLACES ± --- ± --- 2 PLACES ± --- ± --- 1 PLACE ± --- ± ---	mm INCH	DRAWN BY DATE YBELNKIY 2012/01/04	TITLE LC 8 PORT ADAPTER SNAP MOUNT INNER SHUTTERS		
		ANGULAR ± --- °	DRAFT WHERE APPLICABLE MUST REMAIN WITHIN DIMENSIONS	APPROVED BY DATE WCHEN 2012/02/06	MATERIAL NO. SEE TABLE	MOLEX INCORPORATED	SHEET NO. 1 OF 1
					DOCUMENT NO. SD-106121-0450		

LC 8 PORT ADAPTER P/N	ADAPTER COLOR	SPLIT SLEEVE MATERIAL
106121-0450	BLUE	CERAMIC
106121-0460	GREEN	CERAMIC
106121-0470	BEIGE	PHOSPHOR BRONZE
106121-0480	AQUA	PHOSPHOR BRONZE

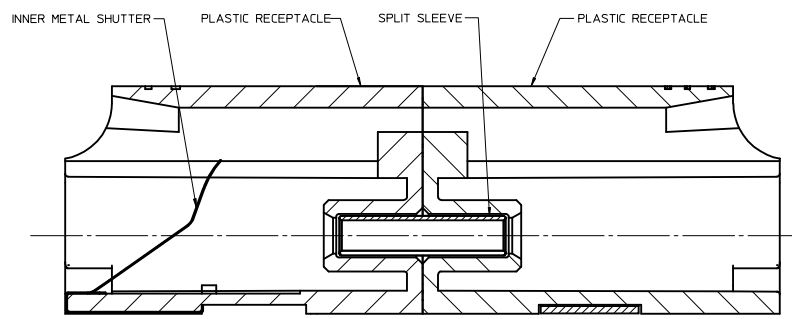
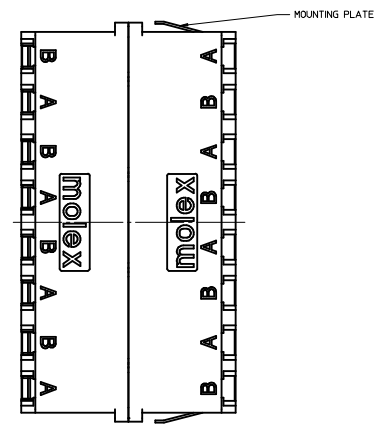

SECTION Z-Z
Scale 10:1

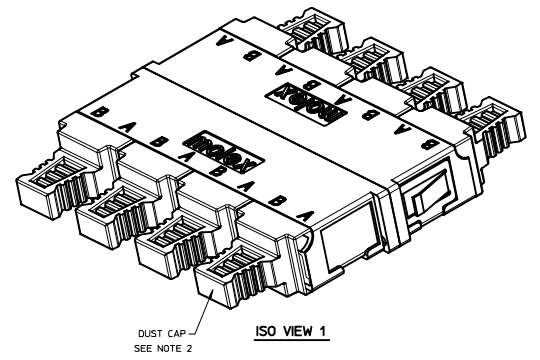
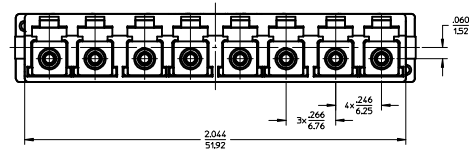
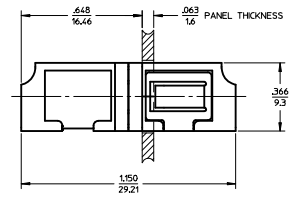
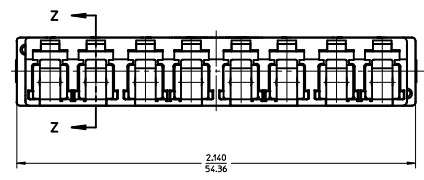

ISO VIEW 1
DUST CAP - SEE NOTE 2

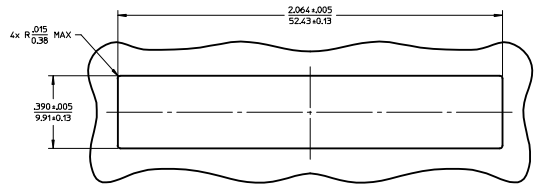

RECOMMENDED MOUNTING PATTERN

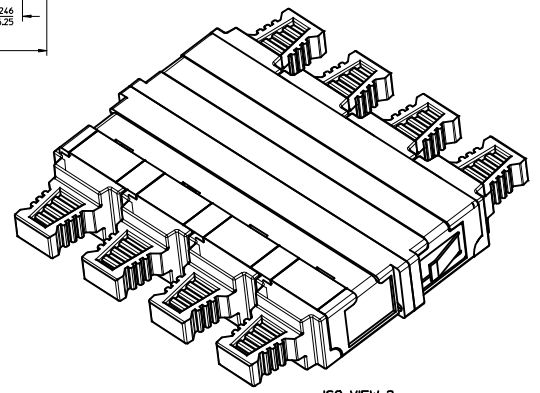

ISO VIEW 2

NOTES:
1. ALL DIMENSIONS ARE FOR REFERENCE.
2. DUST CAPS SHOWN IN ISO VIEWS ONLY.

ENTER DESCRIPTION IEC NO. MF2015-0403 DRAWN BY: CHYK 2015/06/16 APPR: WCHEN 2015/09/25	QUALITY SYMBOLS	GENERAL TOLERANCES (UNLESS SPECIFIED)	DIMENSION STYLE IN/MM	SCALE 3:1	DESIGN UNITS INCH	THIRD ANGLE PROJECTION															
		<table border="1"> <thead> <tr> <th></th> <th>mm</th> <th>INCH</th> </tr> </thead> <tbody> <tr> <td>4 PLACES</td> <td>± ---</td> <td>± ---</td> </tr> <tr> <td>3 PLACES</td> <td>± ---</td> <td>± ---</td> </tr> <tr> <td>2 PLACES</td> <td>± ---</td> <td>± ---</td> </tr> <tr> <td>1 PLACE</td> <td>± ---</td> <td>± ---</td> </tr> </tbody> </table>		mm	INCH	4 PLACES	± ---	± ---	3 PLACES	± ---	± ---	2 PLACES	± ---	± ---	1 PLACE	± ---	± ---	DRAWN BY: YBELENKIY DATE: 2012/01/04 CHECKED BY: DATE:	TITLE: LC 8 PORT ADAPTER SNAP MOUNT INNER SHUTTERS		
		mm	INCH																		
	4 PLACES	± ---	± ---																		
3 PLACES	± ---	± ---																			
2 PLACES	± ---	± ---																			
1 PLACE	± ---	± ---																			
	ANGULAR ± ---°	APPROVED BY: WCHEN DATE: 2012/02/06	MOLEX INCORPORATED																		
	DRAFT WHERE APPLICABLE MUST REMAIN WITHIN DIMENSIONS	MATERIAL NO. SEE TABLE	DOCUMENT NO. SD-106121-0450																		

THIS DRAWING CONTAINS INFORMATION THAT IS PROPRIETARY TO MOLEX INCORPORATED AND SHOULD NOT BE USED WITHOUT WRITTEN PERMISSION