

TPS61177AEVM User Guide

User's Guide



Literature Number: SNVU490
OCTOBER 2015

1	Introduction	4
2	Set-Up	4
2.1	Input/Output Connector Description	4
2.2	TPS61177AEVM Set-Up	6
2.2.1	Installation Guide for GUI Program (Windows7-Compatible).....	6
2.3	Instructions fo Stand-Alone Evaluation	18
2.4	Instructions for Evaluation With Software	19
3	TPS61177AEVM Component Placement	20
4	Schematic	22
5	TPS61177AEVM Bill of Materials	23
6	TPS61177A Usage and Programming	24
6.1	In-Circuit Operation.....	24
6.2	ENABLE.....	24
6.3	Boost Converter Configuration.....	24
6.3.1	Setting the Boost Switching Frequency	24
6.3.2	Setting the Boost Voltage	24
6.3.3	Setting the Boost Switch Slew Rate	24
6.4	LED Driver Configuration	24
6.4.1	Setting the Maximum LED Current	24
6.4.2	PWM Output Frequency	24
6.4.3	Dimming Mode Settings.....	25
6.5	Support for Fault Conditions	25
6.5.1	Thermal Shutdown.....	25
6.5.2	Undervoltage Lockout	25
6.5.3	Undervoltage Lockout	25
6.5.4	Overvoltage Protection	25
6.5.5	Undervoltage Lockout	25
6.6	ID Register.....	25
6.7	EEPROM Default Values	25
6.8	Instructions for Programming EEPROM	26
7	Related Documentation From Texas Instruments	26

List of Figures

1	TPS61177AEVM Evaluation Board	4
2	TPS61177AEVM With USB2Any Board Connected	6
3	TPS61177A GUI - First Page.....	14
4	Option to Select Register Control	15
5	TPS61177A GUI - Register Control Page	16
6	Default Jumper Configuration.....	18
7	TPS61177A EVM Test Setup for Standalone Evaluation	19
8	TPS61177A EVM Test Setup With USB2ANY Connected for Software Control	20
9	TPS61177AEVM Component Placement (Layout)	21
10	TPS61177AEVM Schematic	22

List of Tables

1	Device and Package Configurations	4
---	---	---

1 Introduction

The Texas Instruments TPS61177AEVM evaluation module (EVM) helps designers evaluate the operation and performance of the TPS61177A High-Efficiency LED Backlight Driver. The device offers configurability and can be set up to switch at 450 kHz, 600 kHz, 800 kHz, and 1.2 MHz.

The EVM contains one LED driver (see [Table 1](#)).

Table 1. Device and Package Configurations

LED DRIVER	IC	PACKAGE
U1	TPS61177A	VQFN

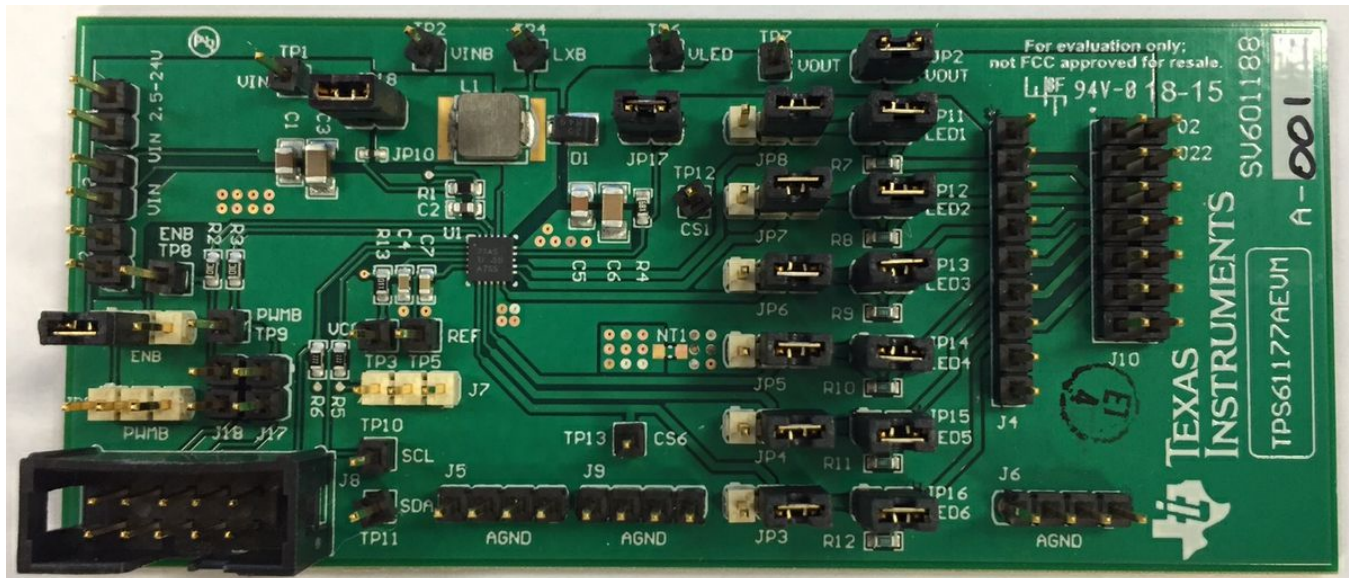

Figure 1. TPS61177AEVM Evaluation Board

2 Set-Up

This section describes the jumpers and connectors on the EVM, as well as how to properly connect, set up, and use the TPS61177AEVM.

2.1 Input/Output Connector Description

J1 - Input: This header is the power input(VIN) terminal for the boost converter. The terminal provides a power (VBAT) connection to allow the user to attach the EVM to a power supply.

J2 - Input: This header is the power input (GND) terminal for the boost converter. The terminal provides a power ground(PGND) connection to allow the user to attach the EVM to a power supply.

J3 - Input: This header is the power input terminal for the boost converter. The terminal provides a power and power ground connection to allow the user to attach the EVM to a power supply using a 2-pin IDC socket and also monitor VIN connected to J1.

J4 - Connector: This connector is for interfacing LED load board via ribbon cable or flying wires.

J5 - GND: This header connects to AGND to provide grounds for signal probing.

J6 - GND: This header connects to AGND to provide grounds for signal probing.

J7 - Input: This header connects to AGND to provide grounds for signal probing.

J8 - Connector: This connector is for interfacing with USB2ANY interface board for I2C communication and control inputs such as PWM and EN signal.

J9 - GND: This header connects to AGND to provide grounds for signal probing.

J10 - Connector: This connector is for interfacing LED load board(WLEDEV-260) via 2 row ribbon cable.

J17 - Connector: This connector is to use PWM signal from USB2ANY instead of V_{IN} or external one chosen by JP9.

J18 - Connector: This connector is to use EN signal from USB2ANY instead of V_{IN} or external one chosen by JP1.

JP1 - Jumper: This jumper is for selecting EN input state between high and low.

JP2 - Jumper: This jumper is for connecting VOUT to J4 and J10 for LED load connection.

JP3 to JP8 - Jumpers: These jumpers are for enabling or disabling LED channels.

JP9 - Jumper: This jumper is used to set PWM control. Connecting pin 1 and pin 2 will send high signal to device and set full on. Connecting pin2 and pin3 will send low signal to device and set off.

JP10 - Jumper: This jumper is a small pad to place jumper resistor or current sensing resistor on VIN.

JP11 to JP16 - Jumpers: These jumpers are used to bypass 10- Ω series resistors to measure LED string current.

JP17 - Jumper: This jumper is used to bypass series resistor on boost feedback (VLED) input.

JP18 - Jumper: This jumper is used to connect VIN to boost circuit or to bypass JP10.

TP1 - Test Point: This header is test point for VIN.

TP2 - Test Point: This header is test point for VINB.

TP3 - Test Point: This header is test point for VCC out.

TP4 - Test Point: This header is test point for boost switch node voltage.

TP5 - Test Point: This header is test point for REF.

TP6 - Test Point: This header is test point for VLED (boost feedback).

TP7 - Test Point: This header is test point for boost output voltage.

TP8 - Test Point: This header is test point for EN.

TP9 - Test Point: This header is test point for PWM input.

TP10 - Test Point: This header is test point for SCL (I2C clock).

TP11 - Test Point: This header is test point for SDA(I2C data).

TP12 - Test Point: This header is test point for CS1(LED driver out for channel 1).

TP13 - Test Point: This header is test point for CS6(LED driver out for channel 6).

2.2 TPS61177AEVM Set-Up

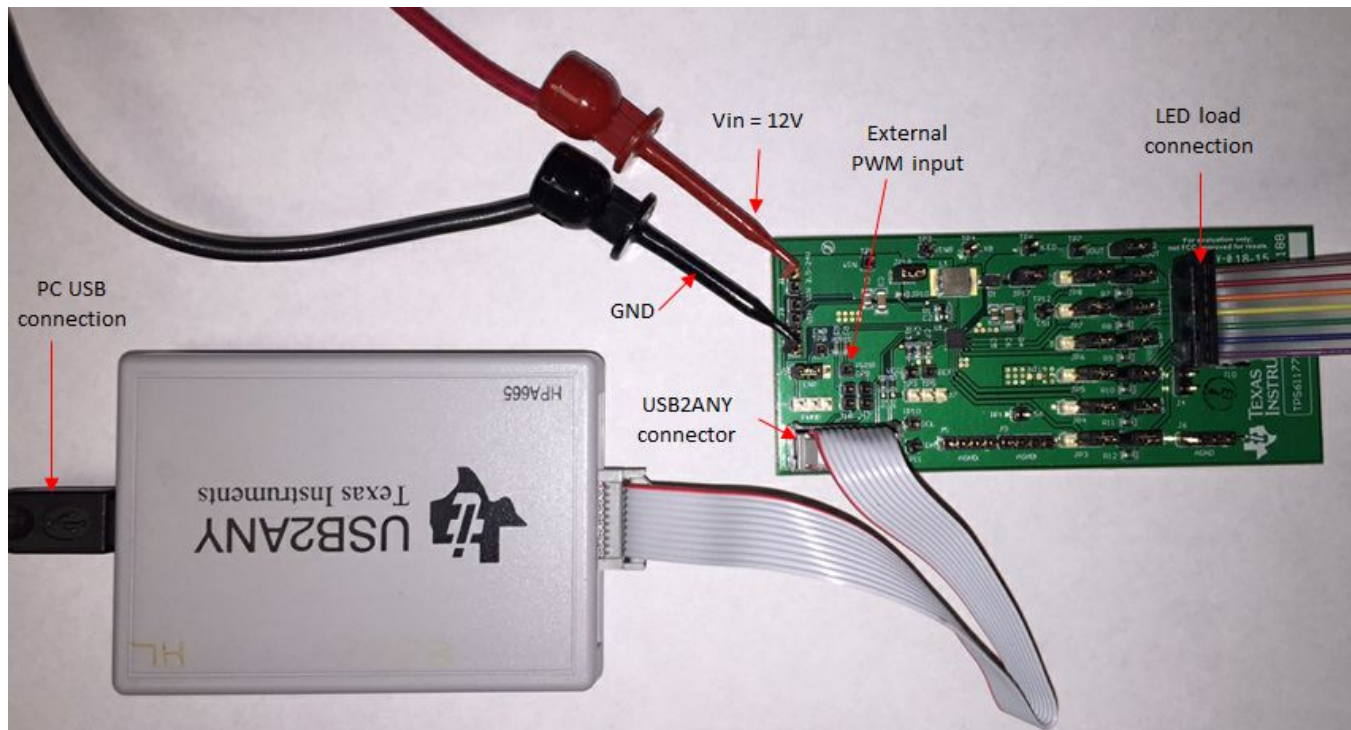

Figure 2. TPS61177AEVM With USB2Any Board Connected

External power must be provided to the board. A standard USB to mini USB cable must be connected to the USB2ANY from a PC. The I2C-compatible interface program provides all of the controls that the TPS61177A device requires.

For proper operation:

- - USB2ANY should be plugged into the PC before the interface program is opened.
- - Install and execute the GUI program – installation guide will be followed below.
- - Power the evaluation board

2.2.1 Installation Guide for GUI Program (Windows7-Compatible)

- Execute `setup_TPS61177A_EVM.exe` file : If it is compressed in zip file format, unzip first in any location.
- Select “Run” though Windows security warning message appears

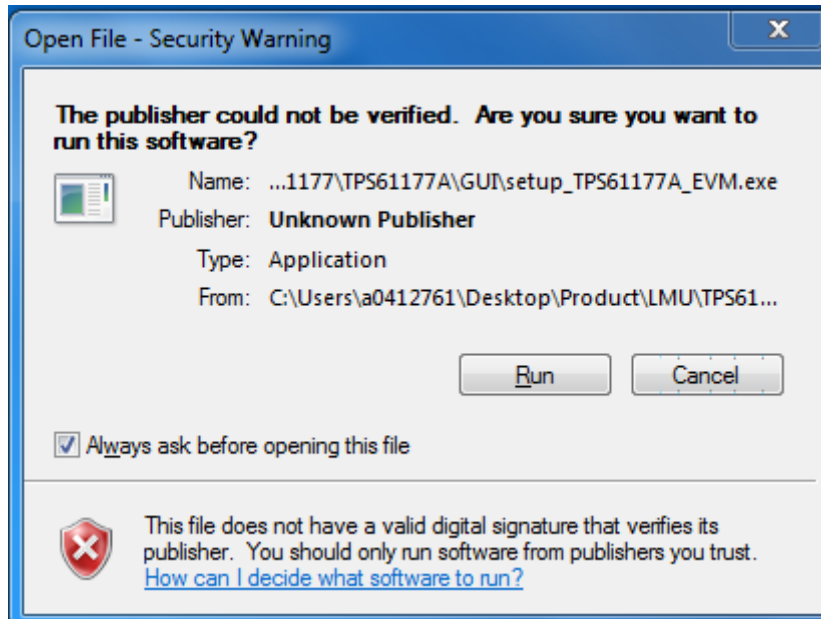

- Click "Next" button.

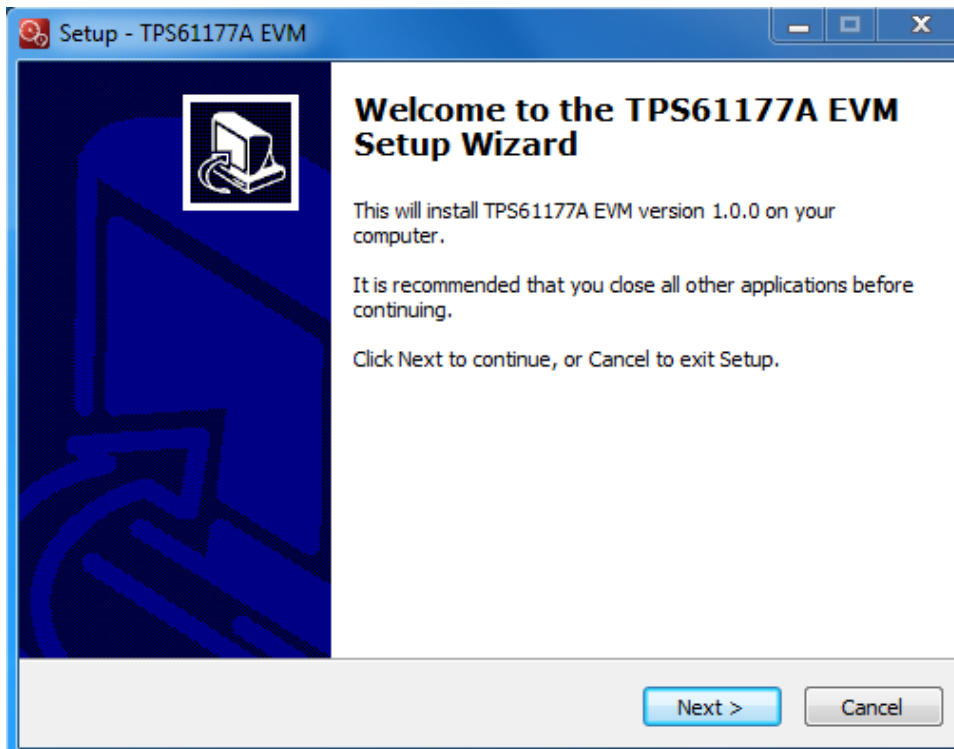

- Check to accept the agreement and click "Next" button to proceed with installation.

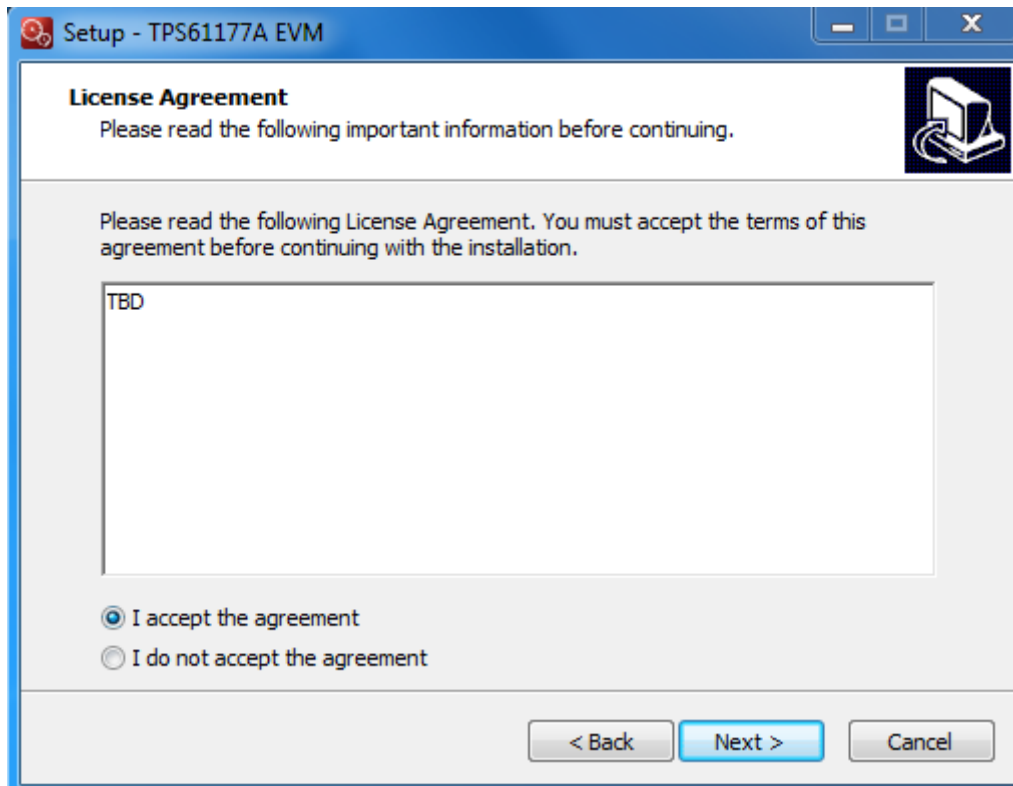

- Click “Next” button. In default, program will be installed in C:\Program Files (x86)\Texas Instruments\TPS61177A folder and Texas Instruments\TPS61177AEVM in start menu.

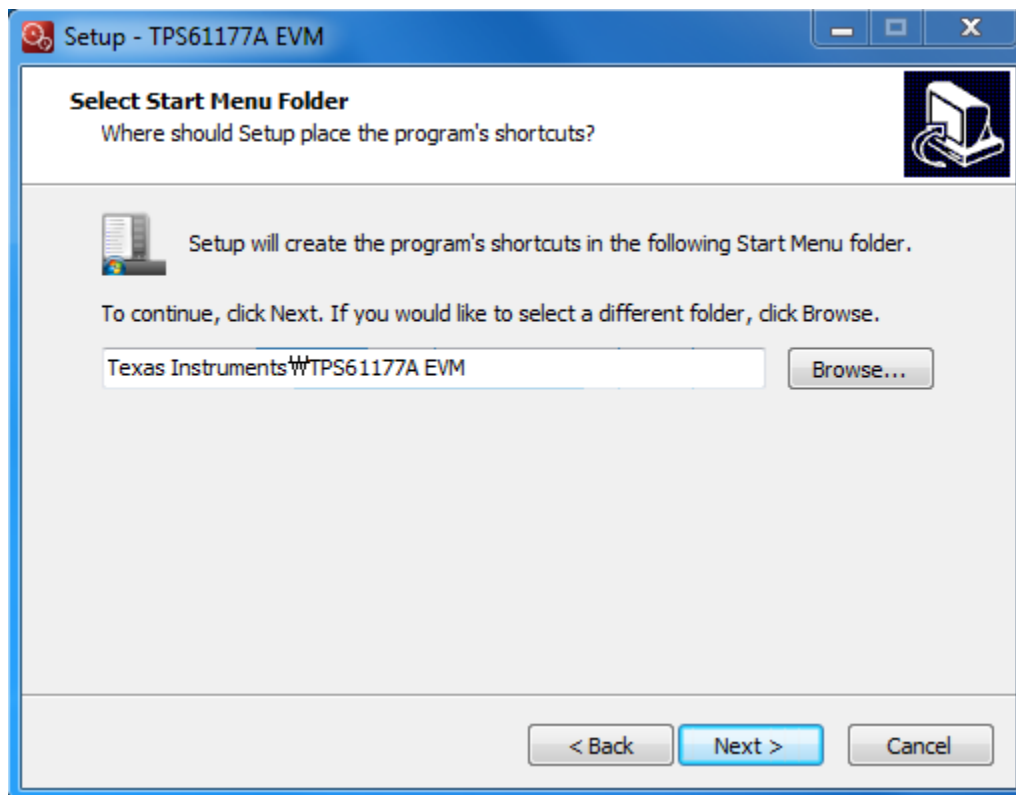

- Check to create a desktop icon for the program and click “Next” button.

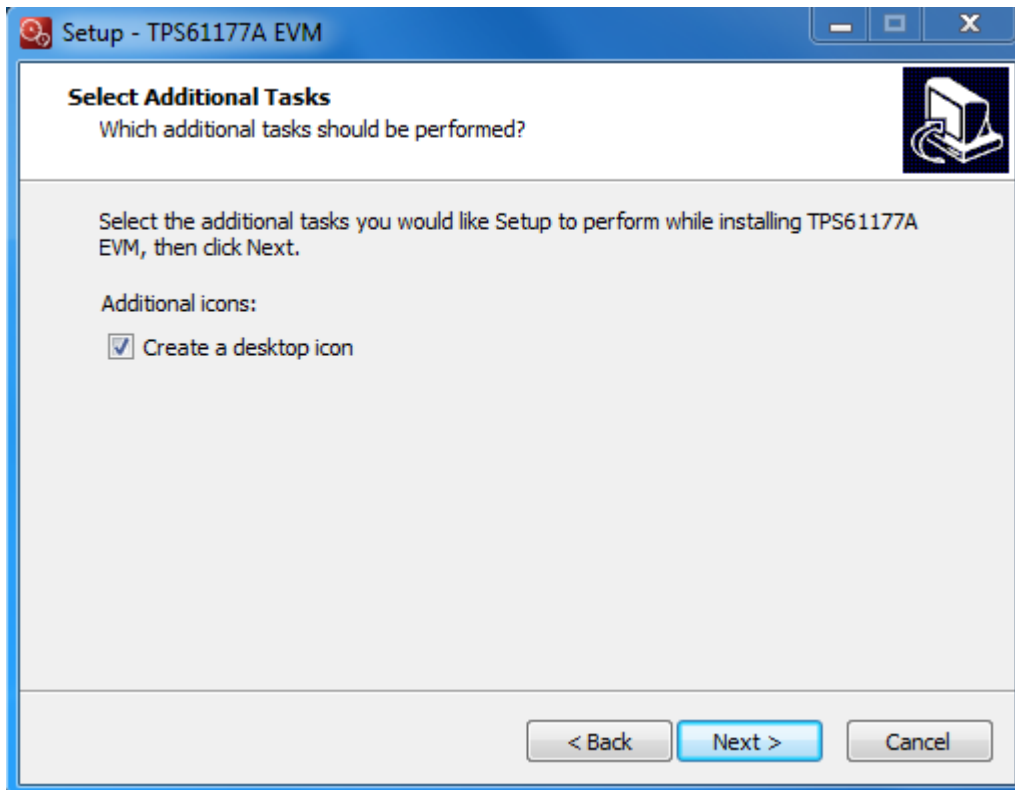

- Click "Install" button.

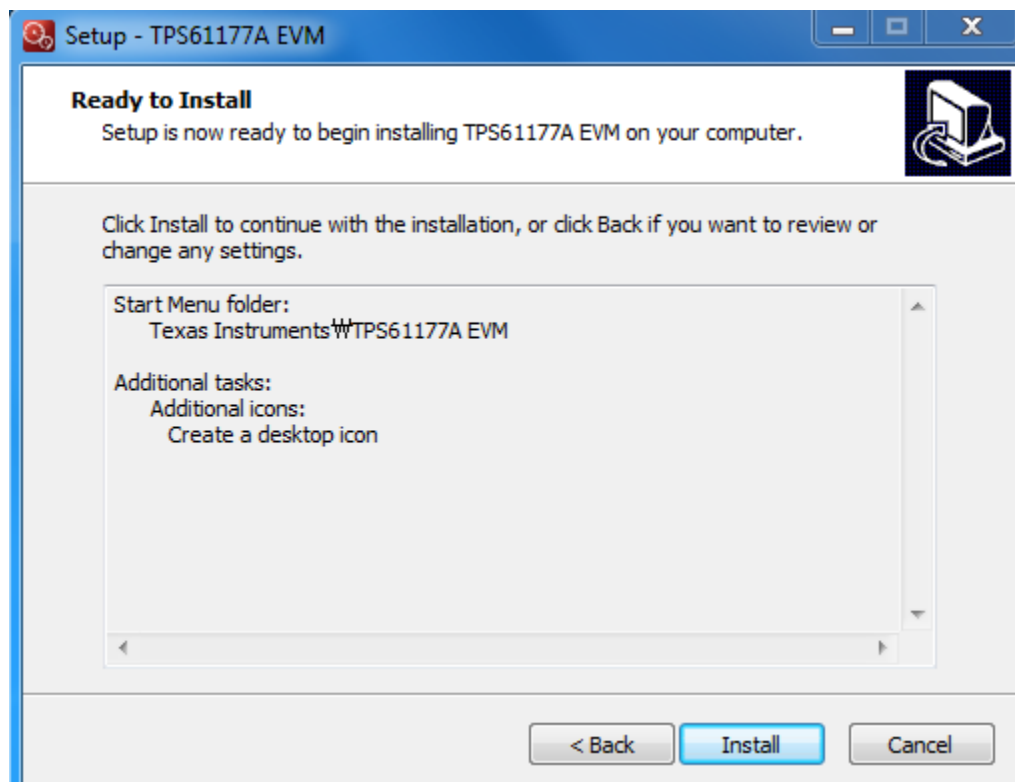

- Click "Finish" button to finish installation and launch the program.

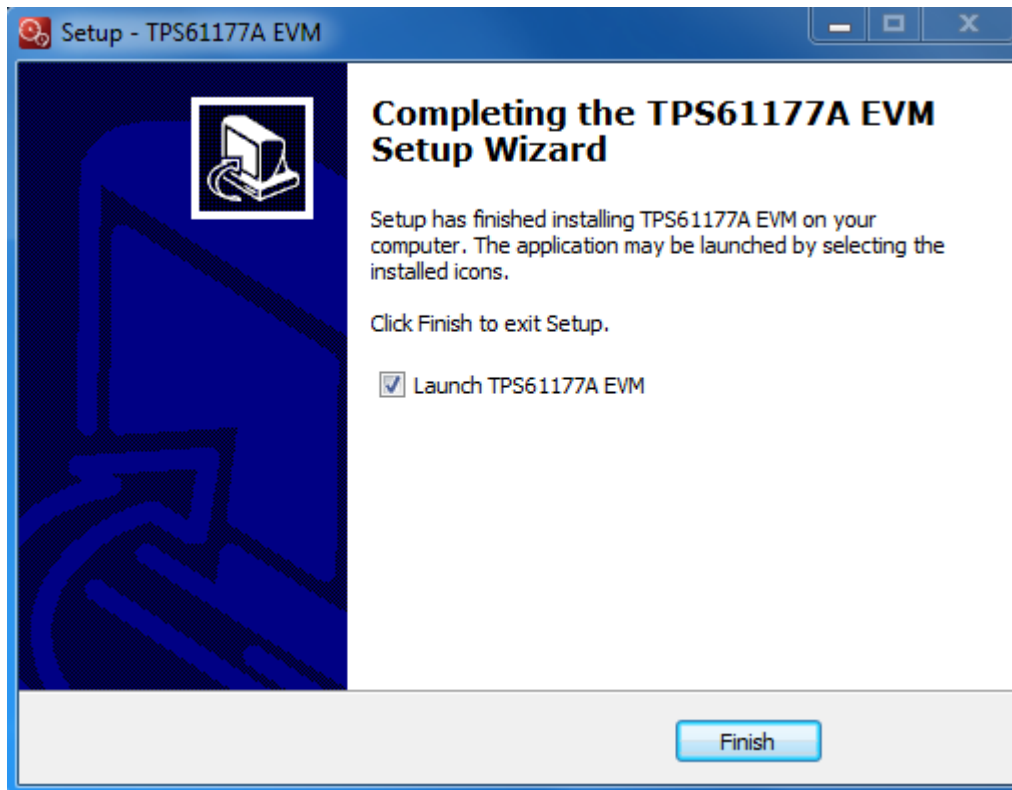

- If firmware update of USB2ANY adaptor is needed this window will pop up.

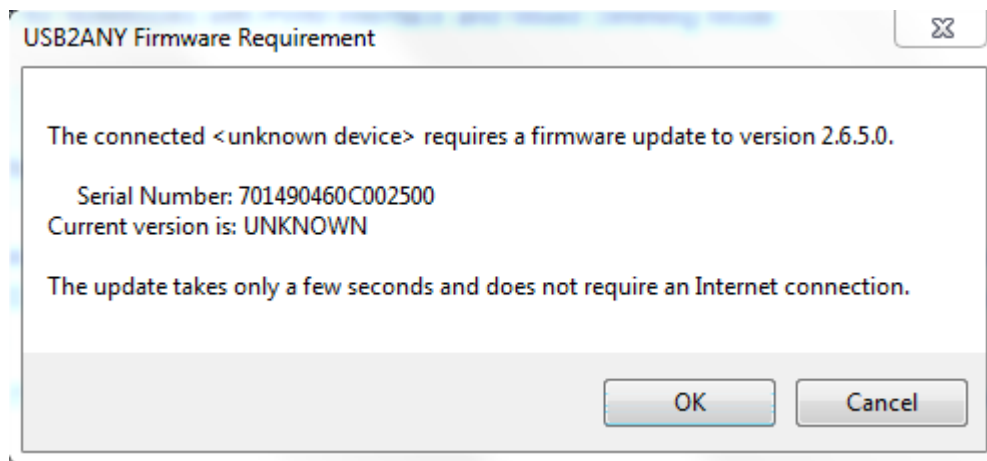

- Depending on firmware versions in USB2ANY adaptors, this firmware uploader will appear, and then follow the instruction on this window.

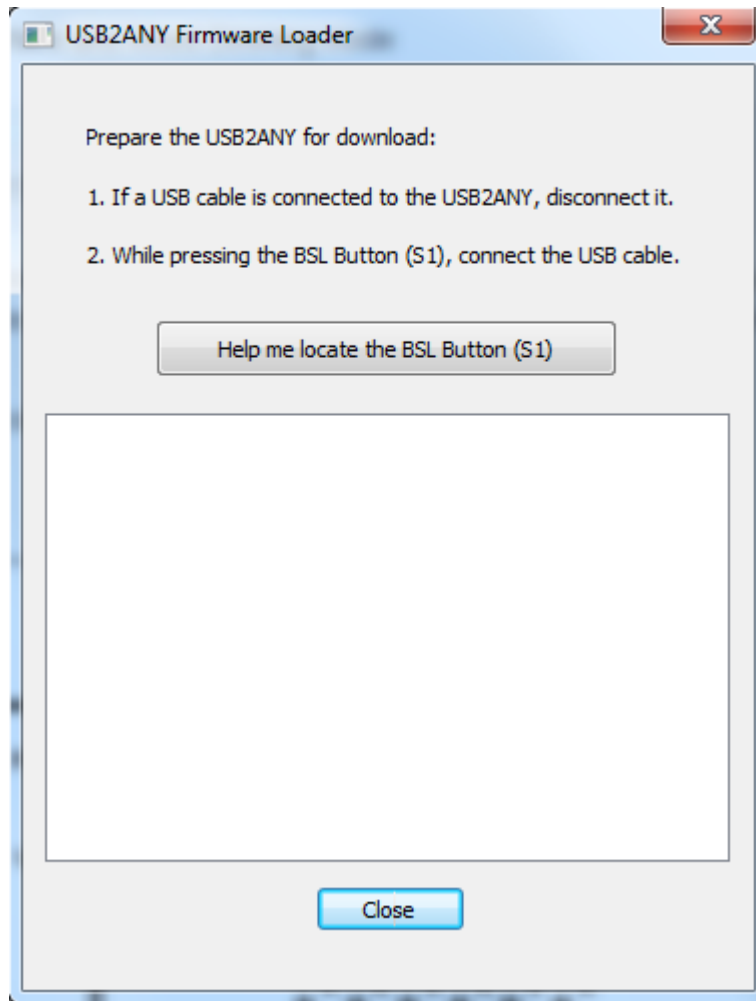

- After disconnecting USB cable and plugging it while pressing S1 button, this window will pop up and it is ready to be updated. Press “Update Firmware” button.

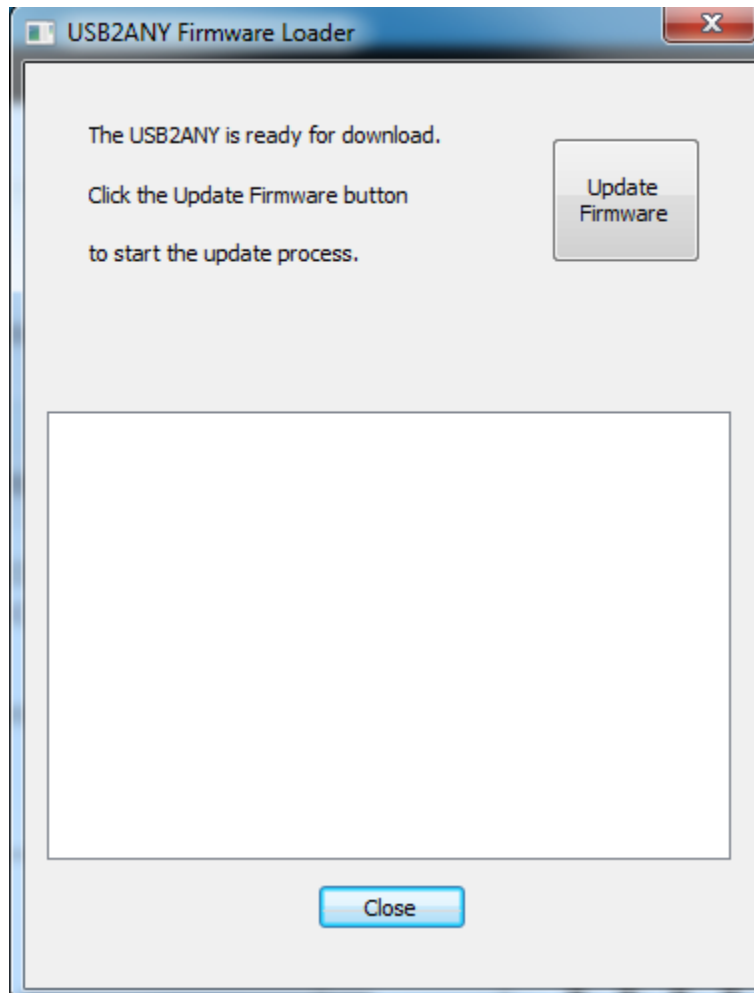

- Update is finished.

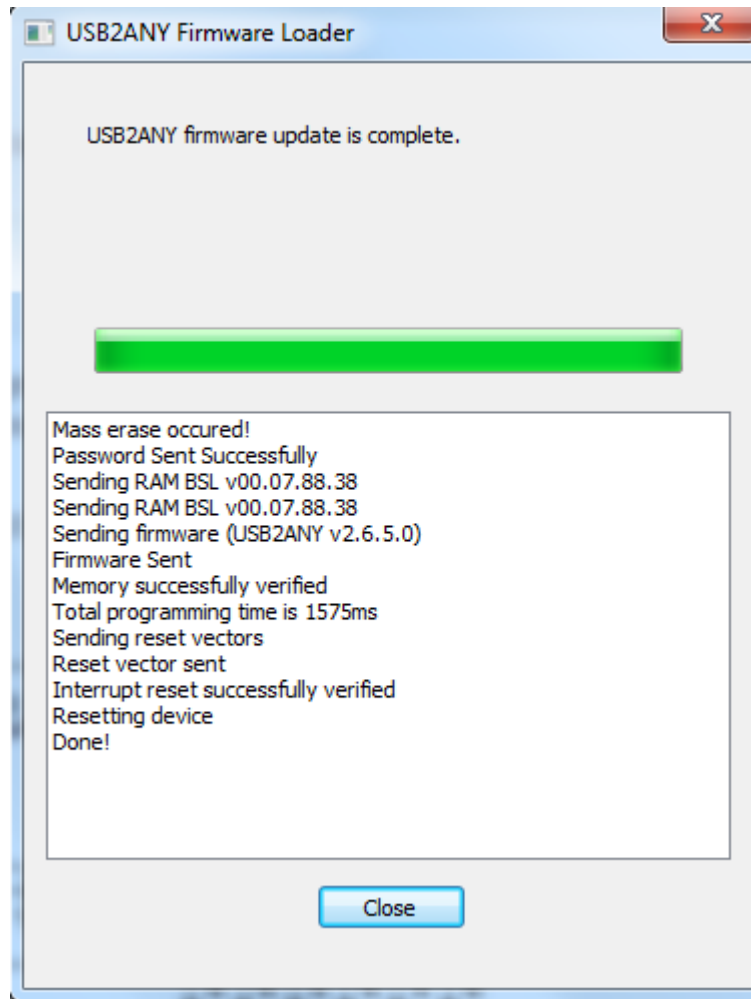

If firmware mismatch window appears after this process again, try to unplug USB cable from the box and plug again.

The USB2ANY is recognized as an HID-compliant device in Windows Device Manager. After firmware update is completed, successful communication with the board by the application is confirmed by the "Connected" field at the bottom left corner with "Green" dot. This green dot becomes red when USB2ANY is not detected by or disconnected from the PC and "Connected" will change to "Not connected".

The first screen of the GUI will show the brief information and connecting diagram of the device (see [Figure 3](#)).

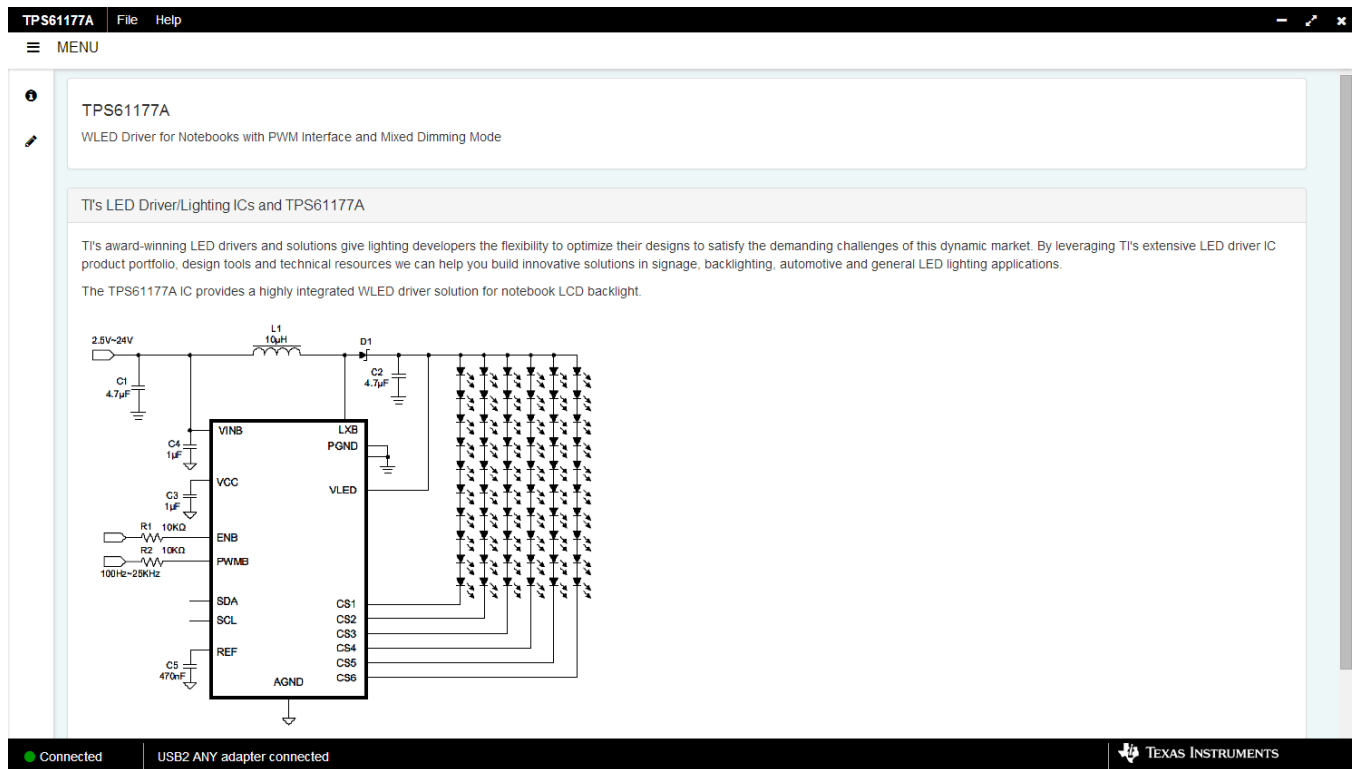



Figure 3. TPS61177A GUI - First Page

In order to control registers of the device, click the icon  on the upper left corner, and select "Registers" page option.

TPS61177A File Help

☰ MENU

- i Introduction
- 🔖 Device
- 🔖 EVM
- 🔧 Registers

s with PWM Interface and Mixed Dimming Mode

Cs and TPS61177A

vers and solutions give lighting developers the flexibility to optimize their desig
ols and technical resources we can help you build innovative solutions in sigr
es a highly integrated WLED driver solution for notebook LCD backlight.

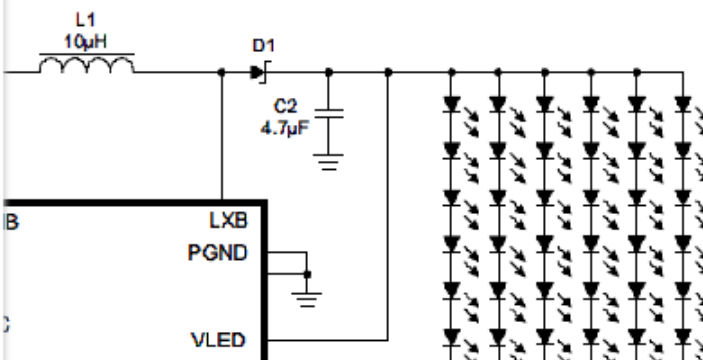

Figure 4. Option to Select Register Control

This is the register control window selected by the page option.

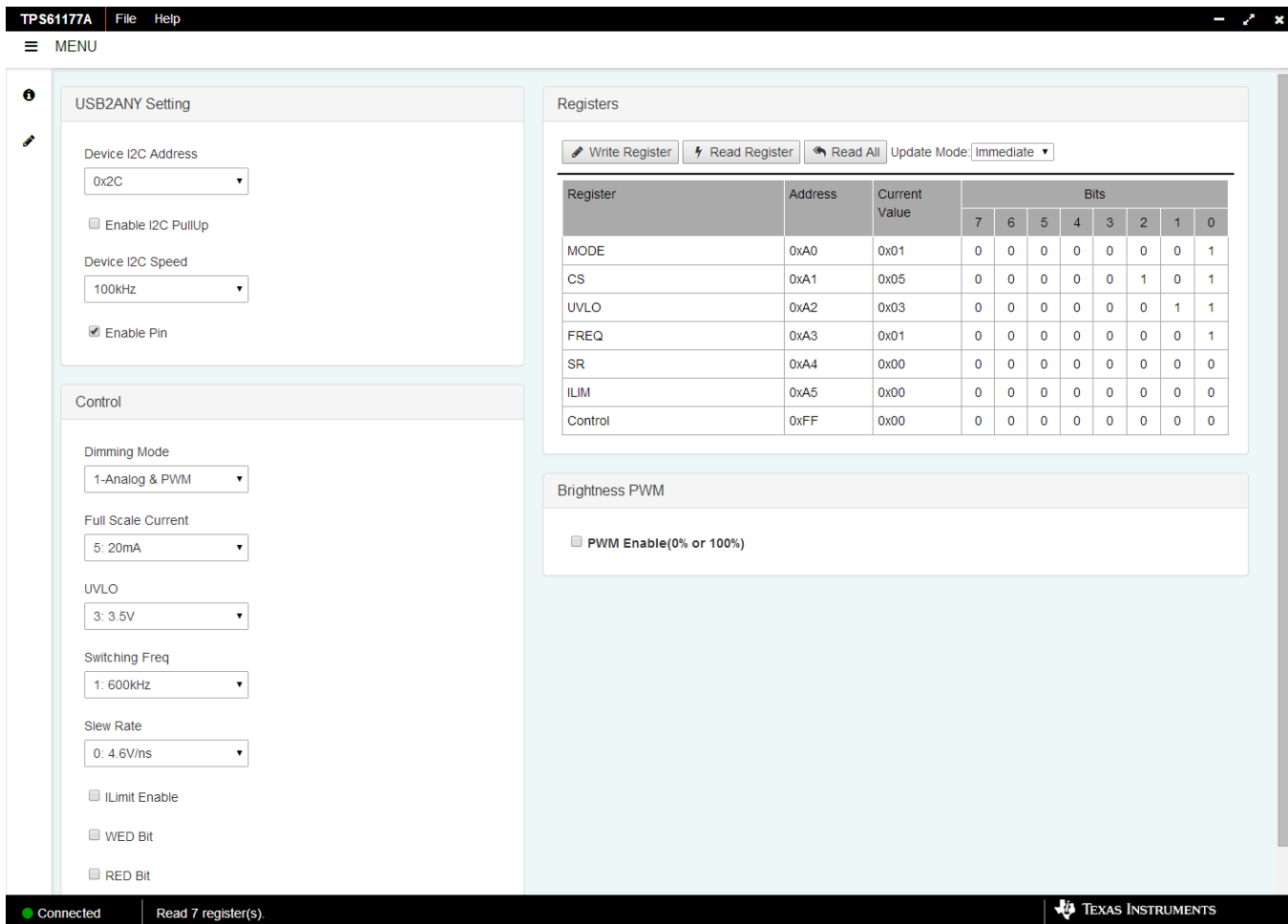

Figure 5. TPS61177A GUI - Register Control Page

The I2C-compatible device address is fixed at 0x58 (8-bit, 2Ch for 7-bit) in this program. The checkbox “Enable I2C Pullup” is used to enable internal pullup (3.3 V) of USB2ANY when I2C pullup on TPS61177AEVM is not available. I2C clock speed can be also selected from 10 kHz to 400 kHz and default speed is set to 100 kHz. EN signal from USB2ANY can be inserted by checking “Enable Pin” checkbox. This is a useful control by GUI when Vin is not used as EN input by JP1 (pin 1 and 2). J18 should be closed in this case. Register table on the right side can show the current values of the registers.

Press “Read All” button to read back all the registers and the values will be updated on this table. If any register values need to be changed, simply double click on the individual bit values to change it in this table or press “Write Register” button to write all the registers at a time if “Deferred” is selected instead of “Immediate” from dropdown box. “Brightness PWM” checkbox can be used to generate PWM input to the device by USB2ANY and J17 should be closed for this control. Vin can be also used as PWM input(100%) when JP9 (pins 1 and 2) is closed.

The minimum procedure for turning on the LEDs is as follows:

1. Connect the LED board (user-designed or WLEDEVM-260 from TI) to the TPS61177AEVM evaluation board. Set jumpers for number of LEDs per string.
2. Connect external power and ground to the board.
 - Suggest 12 V to VIN jack.
 - Connect ground to GND jack.
3. Run “C:\Program Files (x86)\Texas Instruments\TPS61177A\nw.exe” or desktop icon “TPS61177AEVM”.

4. Turn on the external supplies
5. Check the "Enable Pin" box if EN signal from USB2ANY is used. EN will be tied to VIN by default jumper connector setting and the jumper to connect EN to VIN should be removed when EN signal from USB2ANY is used before VIN is enabled.
6. Change brightness with external PWM signal source on pin 2 of JP9 or GUI control (100% by enabling "PWM Enable" checkbox) with USB2ANY. PWM will be tied to VIN by default jumper connector setting and the jumper (JP9) to connect PWM to VIN should be removed when PWM signal from USB2ANY is used before VIN is enabled.

The default dimming mode is analog and PWM mixed mode. This including other controls such as ILED max, boost SW freq/slew rate, and UVLO can be also controlled through S/W GUI. See the TPS61177A data sheet ([SNVSA76](#)) for detailed descriptions of the registers and their usage.

NOTE: Do not change the configuration of the device while the backlight is enabled. First disable the backlight by making sure "Enable Backlight" is unchecked. Then adjust the configuration and turn on the backlight. Changing the configuration while the backlight is on may produce unexpected results.

Register settings can be saved to "*.json" file format by selecting "Save Registers" from file menu.

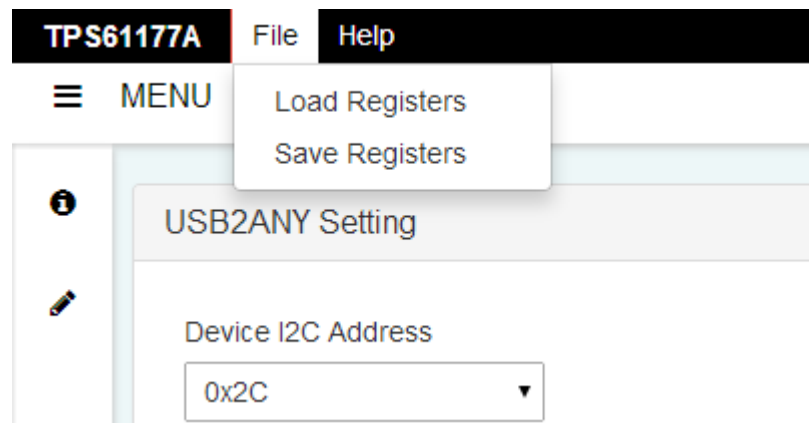

Register settings saved as "*.json" file format can be opened and programmed automatically by selecting "Load Register" from file menu.

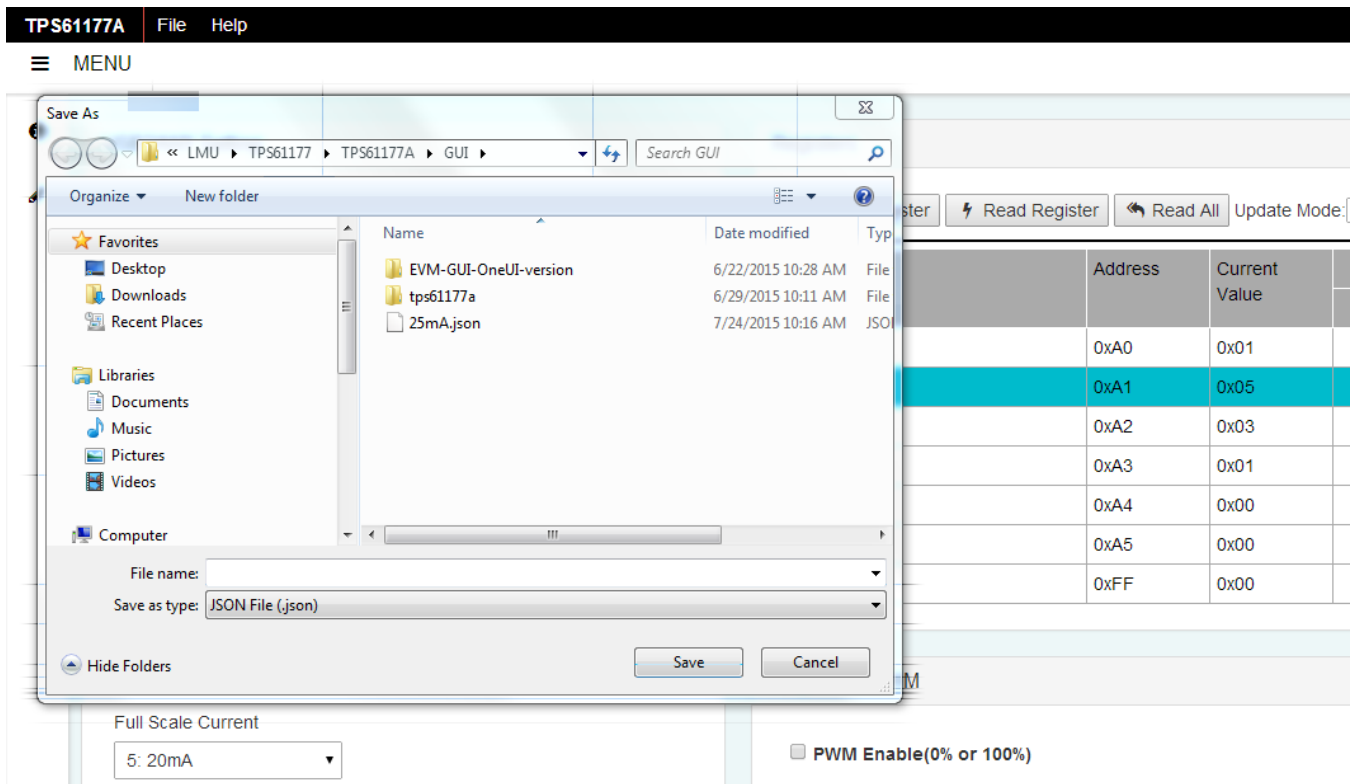

Figure 6. Default Jumper Configuration

2.3 Instructions fo Stand-Alone Evaluation

The TPS61177A EVM can be used for TPS61177A standalone evaluation (without evaluation software) or the evaluation with the software. [Figure 7](#) shows the picture of the TPS61177A EVM board setup for the standalone evaluation (LED load: WLEDEV-260, not included in the kit).

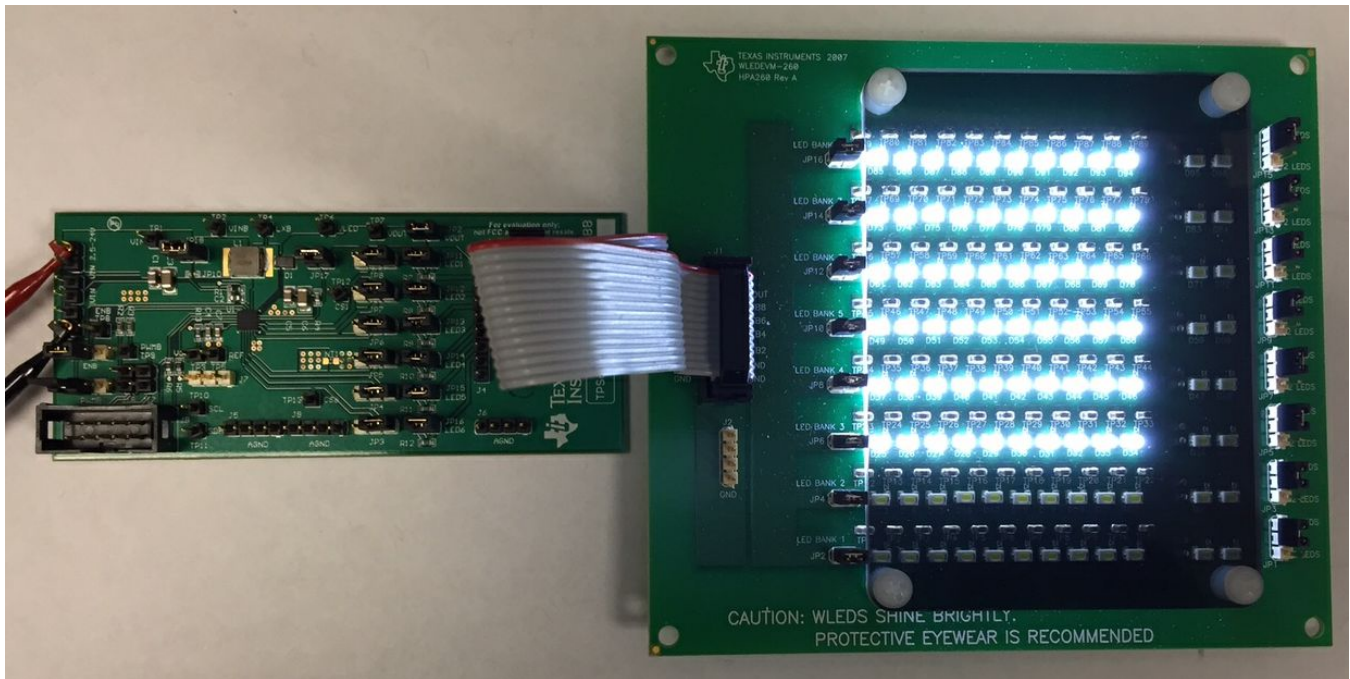

Figure 7. TPS61177A EVM Test Setup for Standalone Evaluation

The minimum procedure for turning on the LEDs with PWM only is as follows:

- Connect external power(VIN) and ground to the board.
- Recommend connecting 12 V to J1. (Any valid V_{IN} 2.7 V to 24 V : recommended boost conversion ratio less than 10).
- Connect ground to J2.
- Connect an external PWM generator with levels 1.8 V or higher (but lower than VINB) with freq between 0.1 kHz and 25 kHz to middle pin of JP9 or simply connect a jumper connector to JP9 to high position (100% PWMB input)
- Check if EN input is at high position of JP1
- Turn on the external supplies.

2.4 Instructions for Evaluation With Software

The TPS61177A evaluation kit includes an I2C-compatible program and USB2ANY board that can help exercise the part in a simple way. Contained in this document is a description of how to use the USB2ANY board with the evaluation board and the interface software. [Figure 8](#) shows the picture of the TPS61177AEVM setup for the evaluation with software.

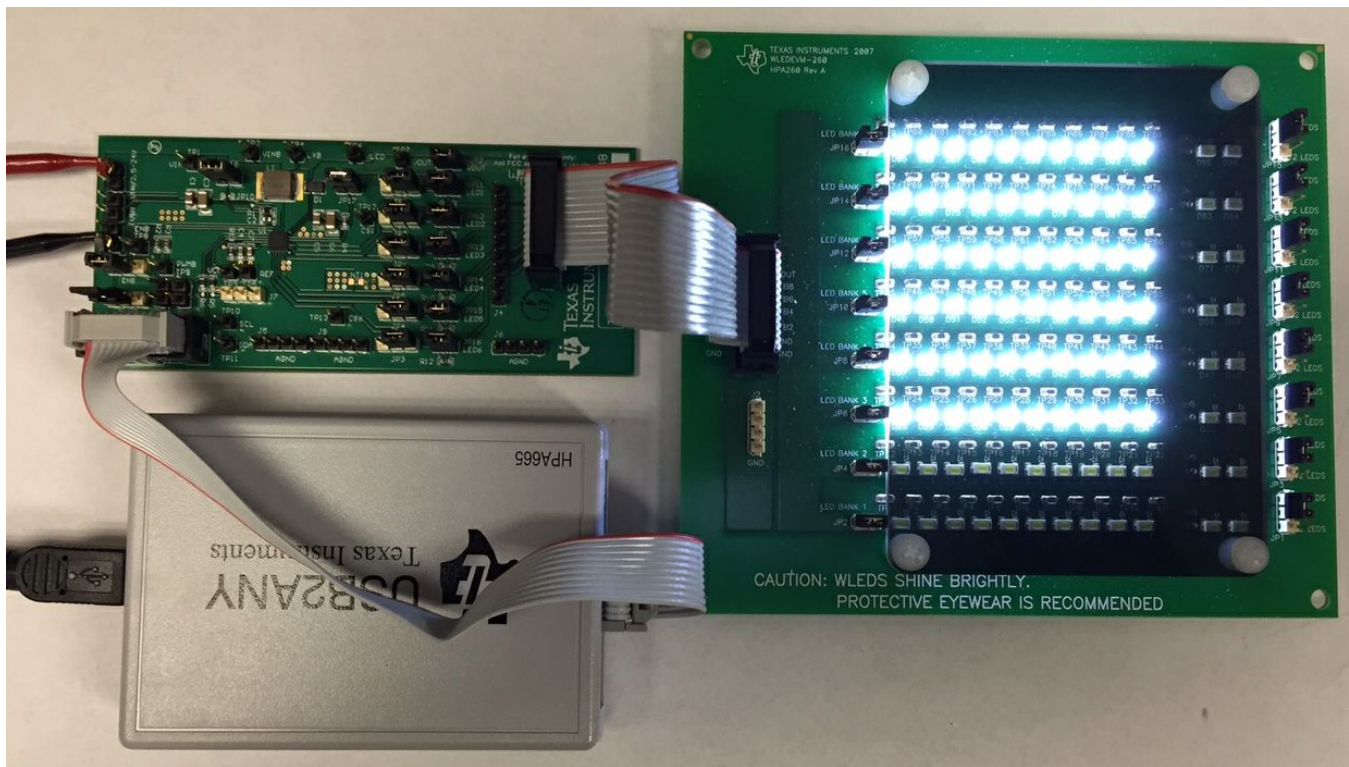

Figure 8. TPS61177A EVM Test Setup With USB2ANY Connected for Software Control

The USB2ANY Board can be connected to the TPS61177AEVM via J8 connector. The USB2ANY Board provides all of the control signals for the simple interface. Power to the part must be provided externally. A standard USB cable must be connected to the USB2ANY board from a PC. The default jumper connection of JP1 (EN) and JP9 (PWM) can be removed to use software control to enable and light up the board. J17 and J18 should be connected for software control of EN and PWM. PWM signal from USB2ANY is just on (100%) /off (0%) signal for simple bring-up test for the board.

3 TPS61177AEVM Component Placement

Figure 9 shows the top PCB layer of the TPS61177A EVM.

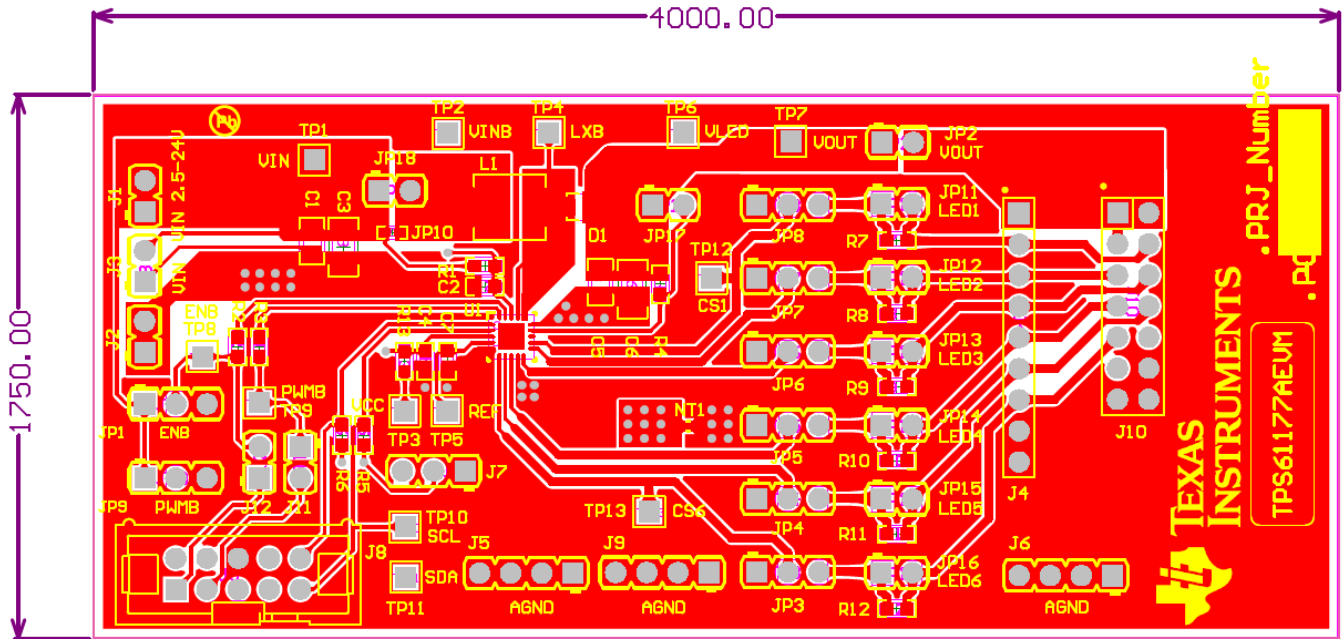

Figure 9. TPS61177AEVM Component Placement (Layout)

4 Schematic

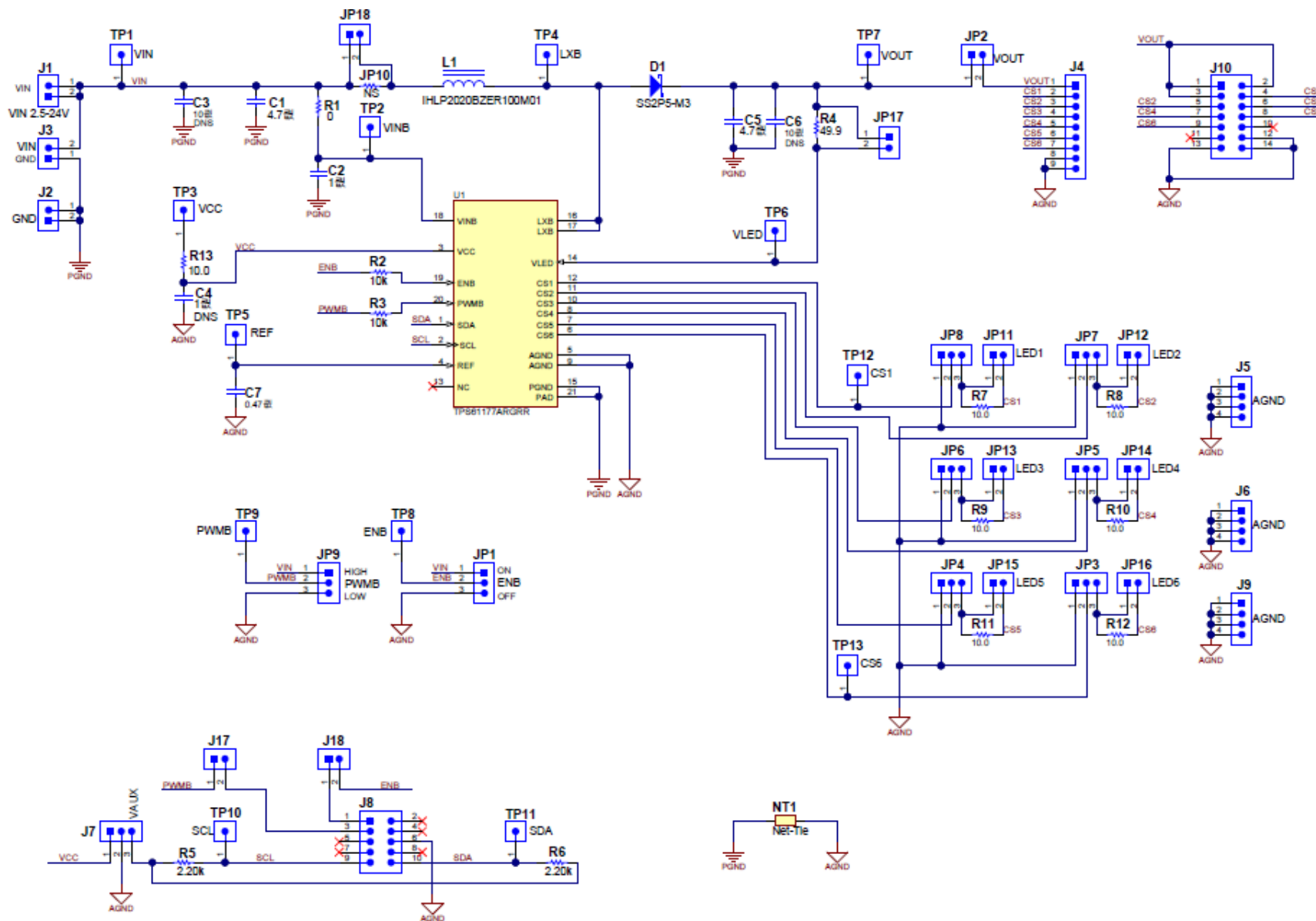

Figure 10. TPS61177AEVM Schematic

5 TPS61177AEVM Bill of Materials

FOOTPRINT	COMMENT	PART NUMBER	DESIGNATOR	DESCRIPTION	QTY
0805_HV	C2012X5R1H475K125AB	C2012X5R1H475K125AB	C1, C5	CAP, CERM, 4.7 μ F, 50 V, +/- 10%, X5R, 0801	2
0603	GMK107BJ105KA-T	GMK107BJ105KA-T	C2	CAP, CERM, 1 μ F, 35 V, +/- 10%, X5R, 0608	1
1206	GMK316AB7106KL	GMK316AB7106KL	C3, C6	CAP, CERM, 10 μ F, 35 V, +/- 10%, X7R, 1200	2
0603	GRM185R60J105KE26D	GRM185R60J105KE26D	C4	CAP, CERM, 1 μ F, 6.3 V, +/- 10%, X5R, 0600	1
0603	GRM188R71E474KA12D	GRM188R71E474KA12D	C7	CAP, CERM, 0.47 μ F, 25 V, +/- 10%, X7R, 0607	1
DO-220AA	SS2P5-M3	SS2P5-M3	D1	Diode, Schottky, 50 V, 2 A, DO-220AA	1
WURTH_61300211121	VIN 2.5-24V	TSW-102-07-G-S	J1	Header, 100mil, 2x1, Gold, TH	1
WURTH_61300211121	GND	TSW-102-07-G-S	J2	Header, 100mil, 2x1, Gold, TH	1
WURTH_61300211121	VIN	TSW-102-07-G-S	J3	Header, 100mil, 2x1, Gold, TH	1
Samtec_TSW-109-07-G-S	TSW-109-07-G-S	TSW-109-07-G-S	J4	Header, 100mil, 9x1, Gold, TH	1
WURTH_61300411121	AGND	TSW-104-07-G-S	J5, J6, J9	Header, 100mil, 4x1, Gold, TH	3
WURTH_61300311121	VAUX	HTSW-103-07-G-S	J7	Header, 100mil, 3x1, Gold, TH	1
CONN_2510-6002	N2510-6002-RB	N2510-6002-RB	J8	Header (shrouded), 100mil, 5x2, High-Temperature, Gold, TH	1
TSW-107-07-G-D	TSW-107-07-G-D	TSW-107-07-G-D	J10	Header, 100mil, 7x2, Gold, TH	1
WURTH_61300211121	TSW-102-07-G-S	TSW-102-07-G-S	J17, J18, JP17, JP18	Header, 100mil, 2x1, Gold, TH	4
WURTH_61300311121	ENB	HTSW-103-07-G-S	JP1	Header, 100mil, 3x1, Gold, TH	1
WURTH_61300211121	VOUT	TSW-102-07-G-S	JP2	Header, 100mil, 2x1, Gold, TH	1
WURTH_61300311121	HTSW-103-07-G-S	HTSW-103-07-G-S	JP3, JP4, JP5, JP6, JP7, JP8	Header, 100mil, 3x1, Gold, TH	6
WURTH_61300311121	PWMB	HTSW-103-07-G-S	JP9	Header, 100mil, 3x1, Gold, TH	1
0402	MCR01MZPJ000	MCR01MZPJ000	JP10	RES, 0, 5%, 0.063 W, 0402	1
WURTH_61300211121	LED1	TSW-102-07-G-S	JP11	Header, 100mil, 2x1, Gold, TH	1
WURTH_61300211121	LED2	TSW-102-07-G-S	JP12	Header, 100mil, 2x1, Gold, TH	1
WURTH_61300211121	LED3	TSW-102-07-G-S	JP13	Header, 100mil, 2x1, Gold, TH	1
WURTH_61300211121	LED4	TSW-102-07-G-S	JP14	Header, 100mil, 2x1, Gold, TH	1
WURTH_61300211121	LED5	TSW-102-07-G-S	JP15	Header, 100mil, 2x1, Gold, TH	1
WURTH_61300211121	LED6	TSW-102-07-G-S	JP16	Header, 100mil, 2x1, Gold, TH	1
IHLP-2020BZ	IHLP2020BZER100M01	IHLP2020BZER100M01	L1	Inductor, Shielded Drum Core, Powdered Iron, 10 μ H, 2.3 A, 0.184 Ω , SM	
NetTie_0603	Net-Tie	Net-Tie	NT1	Single point connection between nets.	1
0603	RC0603JR-070RL	RC0603JR-070RL	R1	RES, 0, 5%, 0.1 W, 0603	1
0603	CRCW060310K0JNEA	CRCW060310K0JNEA	R2, R3	RES, 10 k, 5%, 0.1 W, 0603	2
0603	RC0603FR-0749R9L	RC0603FR-0749R9L	R4	RES, 49.9, 1%, 0.1 W, 0603	1
0603	RC0603FR-072K2L	RC0603FR-072K2L	R5, R6	RES, 2.20 k, 1%, 0.1 W, 0603	2
0603	TNPW060310R0BEEA	TNPW060310R0BEEA	R7, R8, R9, R10, R11, R12	RES, 10.0, 0.1%, 0.1 W, 0603	6
0603	RC0603FR-0710RL	RC0603FR-0710RL	R13	RES, 10.0, 1%, 0.1 W, 0603	1
2SN-BK-G	2SN-BK-G	2SN-BK-G	SH-JP1, SH-JP3, SH-JP4, SH-JP5, SH-JP6, SH-JP7, SH-JP8, SH-JP9, SH-JP11, SH-JP12, SH-JP13, SH-JP14, SH-JP15, SH-JP16	Shunt, 2mm, Gold plated, Black	14
TSW-101-07-G-S	VIN	TSW-101-07-G-S	TP1	Header, 100mil, 1pos, Gold, TH	1
TSW-101-07-G-S	VINB	TSW-101-07-G-S	TP2	Header, 100mil, 1pos, Gold, TH	1
TSW-101-07-G-S	VCC	TSW-101-07-G-S	TP3	Header, 100mil, 1pos, Gold, TH	1
TSW-101-07-G-S	LXB	TSW-101-07-G-S	TP4	Header, 100mil, 1pos, Gold, TH	1
TSW-101-07-G-S	REF	TSW-101-07-G-S	TP5	Header, 100mil, 1pos, Gold, TH	1
TSW-101-07-G-S	VLED	TSW-101-07-G-S	TP6	Header, 100mil, 1pos, Gold, TH	1
TSW-101-07-G-S	VOUT	TSW-101-07-G-S	TP7	Header, 100mil, 1pos, Gold, TH	1
TSW-101-07-G-S	ENB	TSW-101-07-G-S	TP8	Header, 100mil, 1pos, Gold, TH	1
TSW-101-07-G-S	PWMB	TSW-101-07-G-S	TP9	Header, 100mil, 1pos, Gold, TH	1
TSW-101-07-G-S	SCL	TSW-101-07-G-S	TP10	Header, 100mil, 1pos, Gold, TH	1
TSW-101-07-G-S	SDA	TSW-101-07-G-S	TP11	Header, 100mil, 1pos, Gold, TH	1
TSW-101-07-G-S	CS1	TSW-101-07-G-S	TP12	Header, 100mil, 1pos, Gold, TH	1
TSW-101-07-G-S	CS6	TSW-101-07-G-S	TP13	Header, 100mil, 1pos, Gold, TH	1
Label_650x200	Size: 0.65 in. x 0.20 in.	THT-14-423-10	TPS61177AEVM	Thermal Transfer Printable Labels, 0.650 inches W x 0.200 inches H - 10,000 per roll	1
RGR0020A	TPS61177ARGRR	TPS61177ARGRR	U1	WLED Driver for Notebooks with PWM Interface and Mixed Dimming Mode, RGR0020A	1

6 TPS61177A Usage and Programming

The TPS61177A white LED driver can be programmed to support optimal application configuration for boost and LED driver control by register control. The boost converter can operate at 4 switching frequencies. Options can be set for slew rate control. The dimming can be done with a full PWM output, linear current control, or an adaptive combination of the two for the both power savings and good dimming quality. Shutdown for current limit can be also set to protect the circuit.

6.1 In-Circuit Operation

The TPS61177A white LED driver can be controlled during operation with I2C register accesses and PWM input signal. I2C register access can be used for boost and LED driver control, and PWM input can be used to adjust output dimming level of LED driver. Default EEPROM settings can be loaded to internal registers at power up and these registers can be programmed for application conditions and burned in EEPROM by simple I2C sequence.

6.2 ENABLE

The EN pin controls enabling and shutdown of the TPS61177A. A zero value on this pin holds the device in shutdown with minimum current consumption. Register access is not available during shutdown. Boost will not switch until valid PWM input higher than 0% is applied.

6.3 Boost Converter Configuration

The TPS61177A boost converter configuration is determined by the size of the LED array to be driven. Additionally, component constraints will affect operating frequency selection. A calculation method is described in datasheet for selecting the boost operating point and external components along with the desired frequency of operation.

6.3.1 Setting the Boost Switching Frequency

The desired frequency of operation is programmed in the FREQ bits of the A3h register. The default value of FREQ bits is 01b setting 600kHz.

6.3.2 Setting the Boost Voltage

The boost voltage can be adaptively set by the TPS61177A to control the LED headroom in real time which provides the most efficient operation. Boost maximum voltage is 39 V which can support up to 11 to 13 LEDs.

6.3.3 Setting the Boost Switch Slew Rate

The boost switch slew rate can be programmed in the SR bits of the A4h register. The slew rate control can be used for optimization of EMI caused by boost or system efficiency

6.4 LED Driver Configuration

The LED driver can control the power to the LEDs using PWM dimming, pure current control, or an adaptive combination of the two. See the *Adaptive Dimming Control* and *Brightness Control* sections of the data sheet for descriptions.

6.4.1 Setting the Maximum LED Current

The desired maximum LED current is set in the CS bits of A1h. The CS value in A1h can be used for finer adjustments of the maximum current. The default value of CS bits is 101b setting 20 mA.

6.4.2 PWM Output Frequency

PWM output freq on direct PWM mode and mixed dimming mode is determined by input PWM frequency.

6.4.3 Dimming Mode Settings

The TPS61177A has 3 different types of LED dimming mode.

1. Direct PWM mode bypasses PWM input duty and freq to dimming output with same duty and freq. In this case, large output load can switch potentially causing instability of the system such as power fluctuation and audible noise. This mode is not recommended for generic applications.
2. Analog mode changes brightness value from PWM input into constant current value to dimming output. System is more stable than direct PWM mode as there is no huge load transition condition.
3. Analog and PWM Mixed mode includes the advantages of both PWM and analog mode. Input PWM duty is calculated to generate constant analog dimming output from 100% to 25% brightness. Analog to PWM mode transition happens at 25% brightness. The duty of output PWM dimming signal will be 4x of input PWM duty below 25% as max current value will be only quarter of 100% brightness.

6.5 Support for Fault Conditions

6.5.1 Thermal Shutdown

The TPS61177A will shut down the LED outputs and the boost if the temperature exceeds 150°C. The device will exit thermal shutdown when the temperature drops below 135°C.

6.5.2 Undervoltage Lockout

The TPS61177A will not start up until the VINB voltage is higher than the UVLO threshold which is preset by EEPROM register data. During normal operation, if the VINB drops below UVLO with 200-mV hysteresis, the TPS61177A immediately shuts down. There are 5 different UVLO levels from 2.25 V to 4 V.

6.5.3 Undervoltage Lockout

The TPS61177A will not start up until the VINB voltage is higher than the UVLO threshold which is preset by EEPROM register data. During normal operation, if the VINB drops below UVLO with 200-mV hysteresis, the TPS61177A immediately shuts down. There are 5 different UVLO levels from 2.25 V to 4 V.

6.5.4 Overvoltage Protection

The TPS61177A integrates output OVP which is fixed at 39.5 V typically. Once the VLED pin detects the voltage higher than 39.5 V, the boost switching regulator stops switching until the voltage of VLED pin drop below 39.5 V with 500-mV hysteresis.

6.5.5 Undervoltage Lockout

The TPS61177A has a pulse-by-pulse overcurrent limit of 1.8 A (minimum). The PWM switch turns off when the inductor current reaches this current threshold. This protection can be disabled by EEPROM register control (ILIM).

6.6 ID Register

The device slave register of TPS61177A is 58h in 8-bit (7bit slave address + R/W bit) or 2Ch in 7-bit without R/W bit.

6.7 EEPROM Default Values

Refer to TPS61177A data sheet ([SNVSA76](#)) for detailed descriptions.

6.8 Instructions for Programming EEPROM

Once TPS61177A register settings are finished to have optimal values for the application, internal EEPROM values can be written with the programmed register settings, so they can be loaded to register at next power up. Writing 80h to register addr FFh will write EEPROM with updated values or check “WED bit” checkbox of the GUI.

7 Related Documentation From Texas Instruments

See the TPS61177A data sheet ([SNVSA76](#)) for more information.

IMPORTANT NOTICE

Texas Instruments Incorporated and its subsidiaries (TI) reserve the right to make corrections, enhancements, improvements and other changes to its semiconductor products and services per JESD46, latest issue, and to discontinue any product or service per JESD48, latest issue. Buyers should obtain the latest relevant information before placing orders and should verify that such information is current and complete. All semiconductor products (also referred to herein as "components") are sold subject to TI's terms and conditions of sale supplied at the time of order acknowledgment.

TI warrants performance of its components to the specifications applicable at the time of sale, in accordance with the warranty in TI's terms and conditions of sale of semiconductor products. Testing and other quality control techniques are used to the extent TI deems necessary to support this warranty. Except where mandated by applicable law, testing of all parameters of each component is not necessarily performed.

TI assumes no liability for applications assistance or the design of Buyers' products. Buyers are responsible for their products and applications using TI components. To minimize the risks associated with Buyers' products and applications, Buyers should provide adequate design and operating safeguards.

TI does not warrant or represent that any license, either express or implied, is granted under any patent right, copyright, mask work right, or other intellectual property right relating to any combination, machine, or process in which TI components or services are used. Information published by TI regarding third-party products or services does not constitute a license to use such products or services or a warranty or endorsement thereof. Use of such information may require a license from a third party under the patents or other intellectual property of the third party, or a license from TI under the patents or other intellectual property of TI.

Reproduction of significant portions of TI information in TI data books or data sheets is permissible only if reproduction is without alteration and is accompanied by all associated warranties, conditions, limitations, and notices. TI is not responsible or liable for such altered documentation. Information of third parties may be subject to additional restrictions.

Resale of TI components or services with statements different from or beyond the parameters stated by TI for that component or service voids all express and any implied warranties for the associated TI component or service and is an unfair and deceptive business practice. TI is not responsible or liable for any such statements.

Buyer acknowledges and agrees that it is solely responsible for compliance with all legal, regulatory and safety-related requirements concerning its products, and any use of TI components in its applications, notwithstanding any applications-related information or support that may be provided by TI. Buyer represents and agrees that it has all the necessary expertise to create and implement safeguards which anticipate dangerous consequences of failures, monitor failures and their consequences, lessen the likelihood of failures that might cause harm and take appropriate remedial actions. Buyer will fully indemnify TI and its representatives against any damages arising out of the use of any TI components in safety-critical applications.

In some cases, TI components may be promoted specifically to facilitate safety-related applications. With such components, TI's goal is to help enable customers to design and create their own end-product solutions that meet applicable functional safety standards and requirements. Nonetheless, such components are subject to these terms.

No TI components are authorized for use in FDA Class III (or similar life-critical medical equipment) unless authorized officers of the parties have executed a special agreement specifically governing such use.

Only those TI components which TI has specifically designated as military grade or "enhanced plastic" are designed and intended for use in military/aerospace applications or environments. Buyer acknowledges and agrees that any military or aerospace use of TI components which have **not** been so designated is solely at the Buyer's risk, and that Buyer is solely responsible for compliance with all legal and regulatory requirements in connection with such use.

TI has specifically designated certain components as meeting ISO/TS16949 requirements, mainly for automotive use. In any case of use of non-designated products, TI will not be responsible for any failure to meet ISO/TS16949.

Products

Audio	www.ti.com/audio
Amplifiers	amplifier.ti.com
Data Converters	dataconverter.ti.com
DLP® Products	www.dlp.com
DSP	dsp.ti.com
Clocks and Timers	www.ti.com/clocks
Interface	interface.ti.com
Logic	logic.ti.com
Power Mgmt	power.ti.com
Microcontrollers	microcontroller.ti.com
RFID	www.ti-rfid.com
OMAP Applications Processors	www.ti.com/omap
Wireless Connectivity	www.ti.com/wirelessconnectivity

Applications

Automotive and Transportation	www.ti.com/automotive
Communications and Telecom	www.ti.com/communications
Computers and Peripherals	www.ti.com/computers
Consumer Electronics	www.ti.com/consumer-apps
Energy and Lighting	www.ti.com/energy
Industrial	www.ti.com/industrial
Medical	www.ti.com/medical
Security	www.ti.com/security
Space, Avionics and Defense	www.ti.com/space-avionics-defense
Video and Imaging	www.ti.com/video

TI E2E Community

e2e.ti.com