



Tango 36

3 Port MiMo dual band WiFi ceiling mounted Antenna



Key Features

- Dual Frequency WiFi 2.4 and 5GHz
- MiMo - 3 antennas covering all 3 planes
- IEEE 802.11ac ready

General Description

The Tango 36 antenna is a 3 antenna MiMo WiFi antenna for both 2.4 and 5GHz bands, housed in a weather resistant, bolt through, dome for ceiling mounting.

The three antennas are set in three planes maximising multi-path signal reception and minimising signal fade due to multi-path interference.

Alternative connectors and cable lengths can be specified for volume orders.

Additional Considerations

- Robust weather resistant design
- Multi-path signal reception/transmission

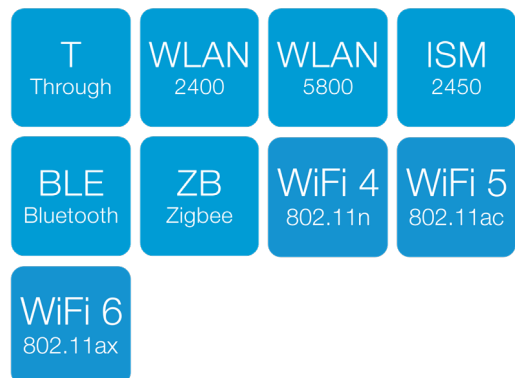



Tango 36

3 Port MiMo dual band WiFi ceiling mounted Antenna

Electrical Specifications

Impedance:	50 Ohm
VSWR:	≤1.7
Gain:	2.4GHz: 2 - 6dBi 5GHz: 3 - 8dBi
Frequency Range:	2.4 - 2.5GHz / 5.1 - 5.975GHz
Beam Width:	H:360° / E:45°
Max power:	10W
Polarization:	Vertical

Mechanical Specifications

Operating Temperature:	-30 - +60°C
Dimensions:	L90 Ø x H40.5mm
Cable:	Low Loss PRO100 x 3
Connector:	3x SMA Male Reverse Polarity
Material Radome:	ABS

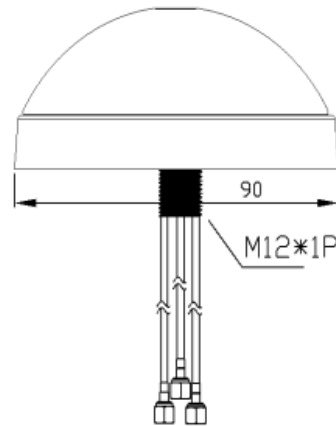

VSWR - Antenna 1 - Vertical

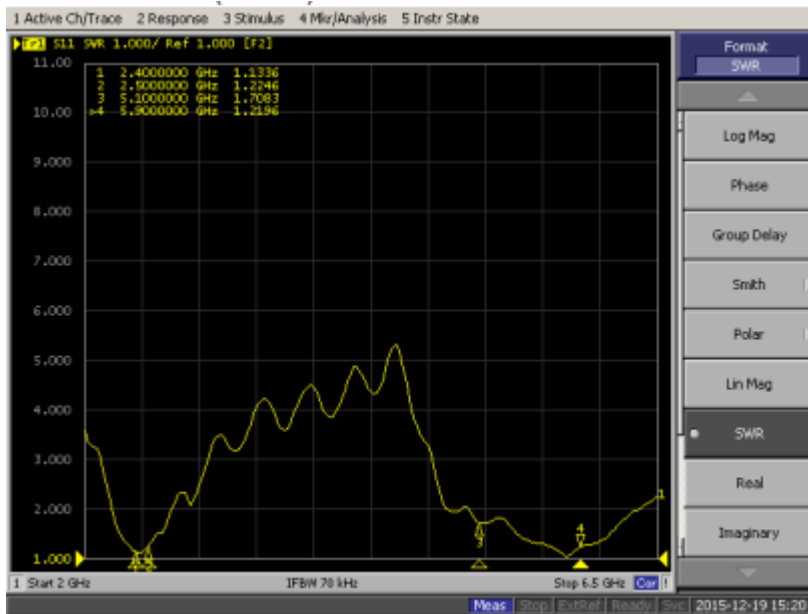



Tango 36

3 Port MiMo dual band WiFi ceiling mounted Antenna

Return Loss - Antenna 1 - Vertical

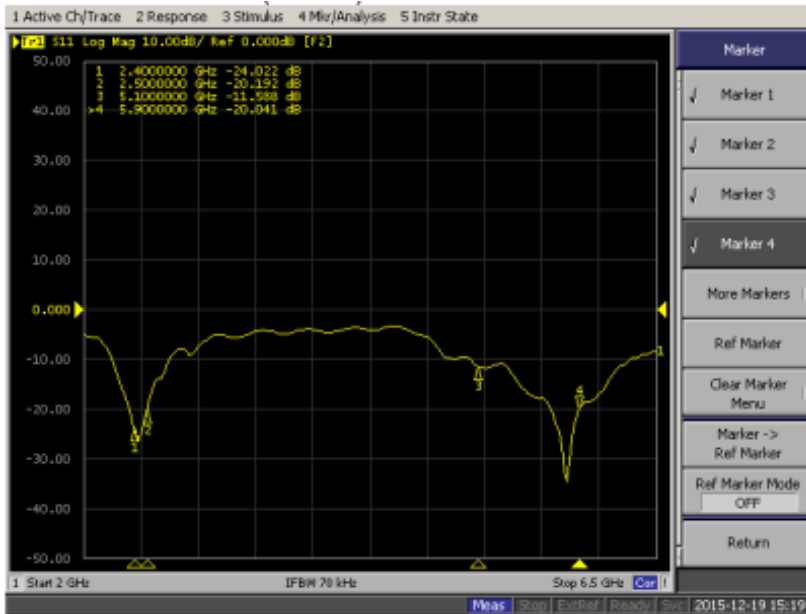

VSWR - Antenna 2 - Horizontal - 90°

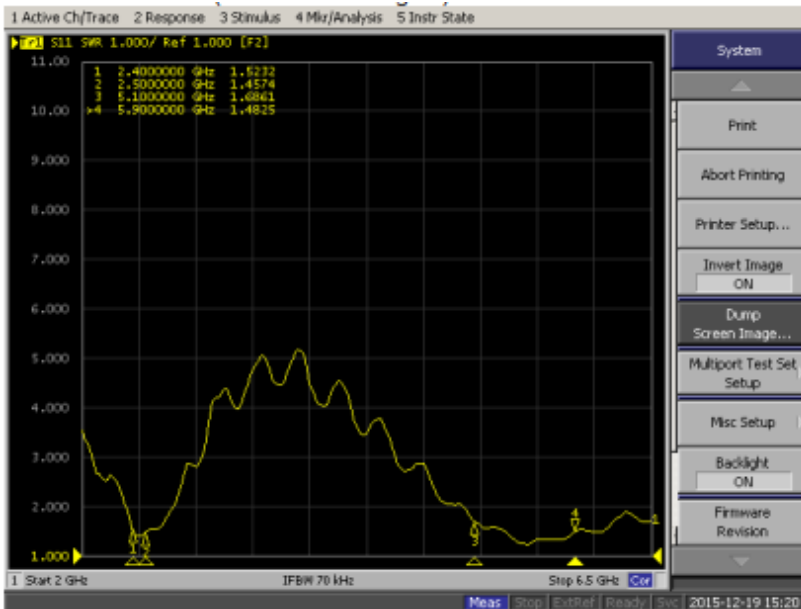



Tango 36

3 Port MiMo dual band WiFi ceiling mounted Antenna

Return Loss - Antenna 2 - Horizontal - 90°

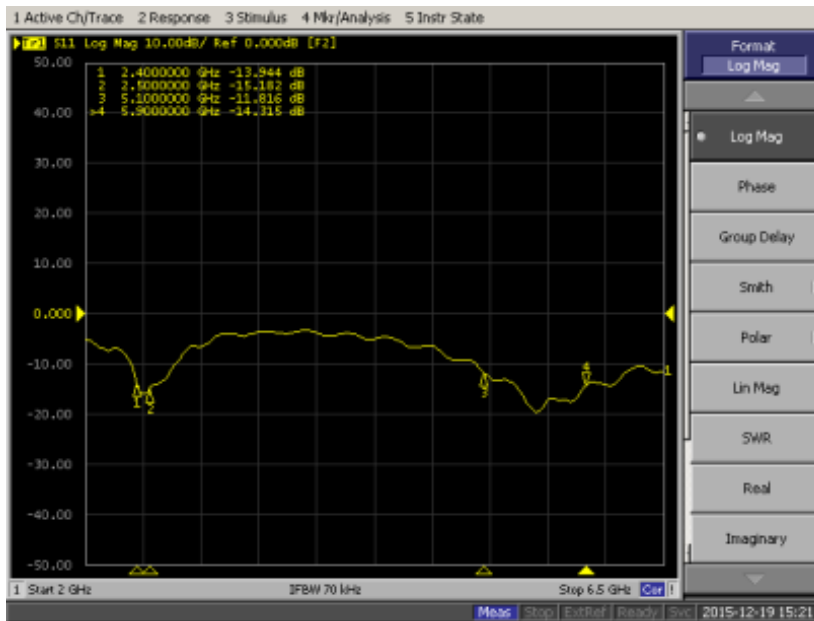

VSWR - Antenna 3 - Horizontal - 0°

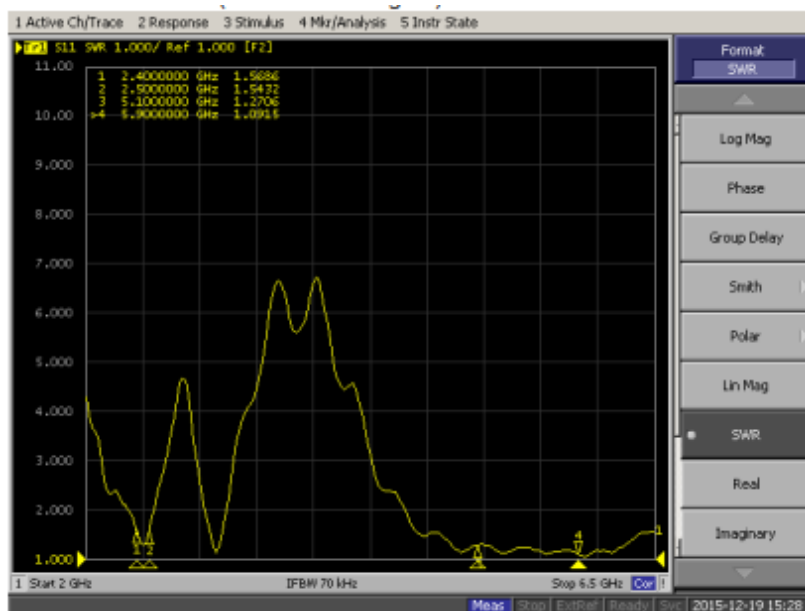



Tango 36

3 Port MiMo dual band WiFi ceiling mounted Antenna

Return Loss - Antenna 3 - Horizontal - 0°

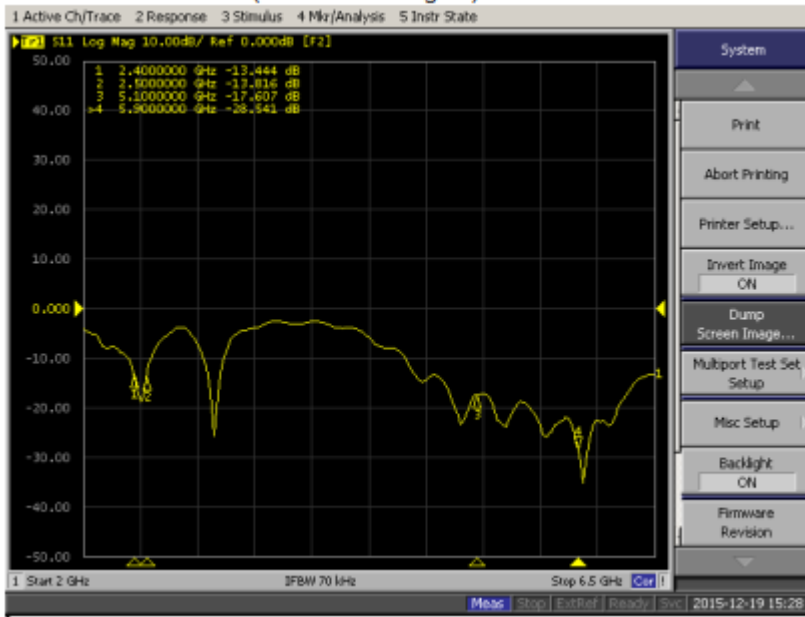

Radiation Patterns

2.4 - 2.5GHz Antenna 1 - Vertical

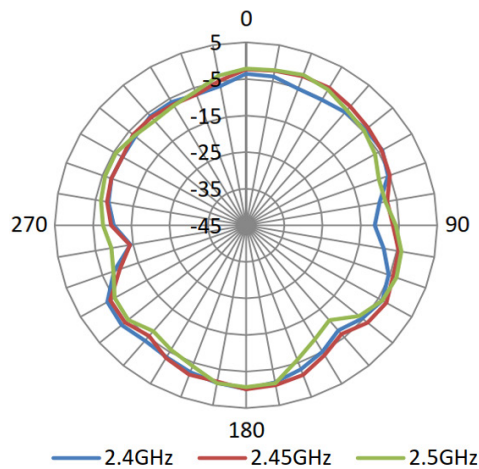
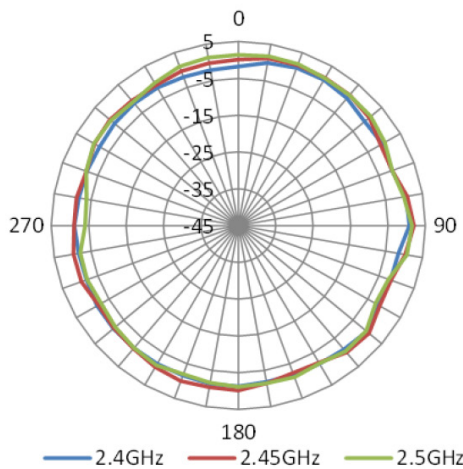



Tango 36

3 Port MiMo dual band WiFi ceiling mounted Antenna

2.4 - 2.5GHz Antenna 2 - Horizontal - 90°

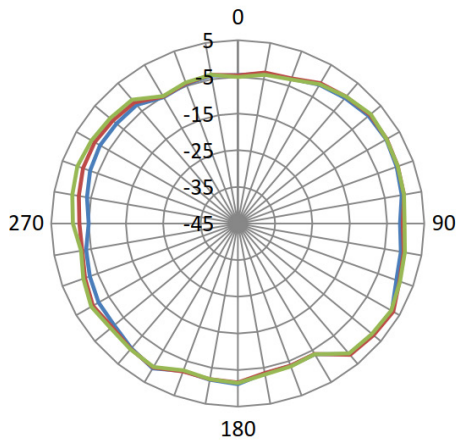

— 2.4GHz — 2.45GHz — 2.5GHz

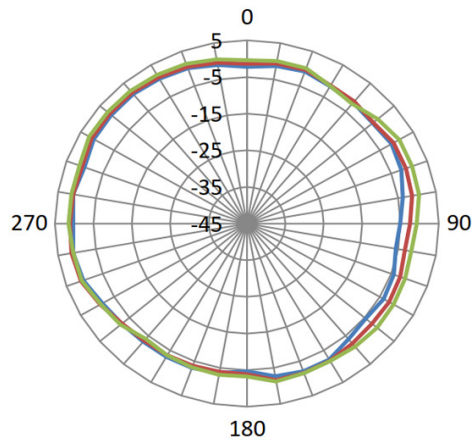

— 2.4GHz — 2.45GHz — 2.5GHz

2.4 - 2.5GHz Antenna 3 - Horizontal - 0°

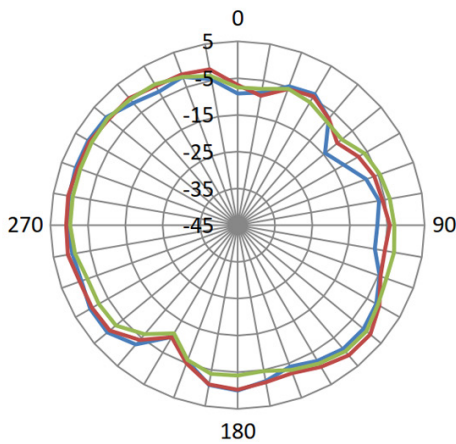

— 2.4GHz — 2.45GHz — 2.5GHz

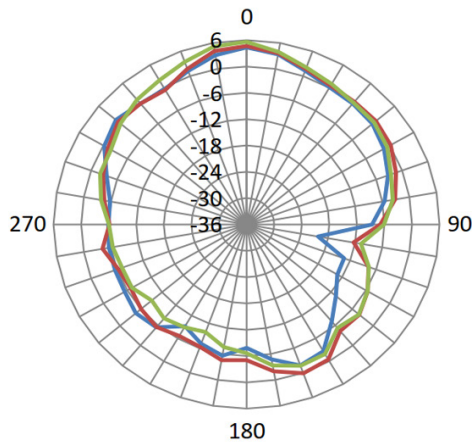

— 2.4GHz — 2.45GHz — 2.5GHz



Tango 36

3 Port MiMo dual band WiFi ceiling mounted Antenna

5.1 - 5.9GHz Antenna 1 - Vertical

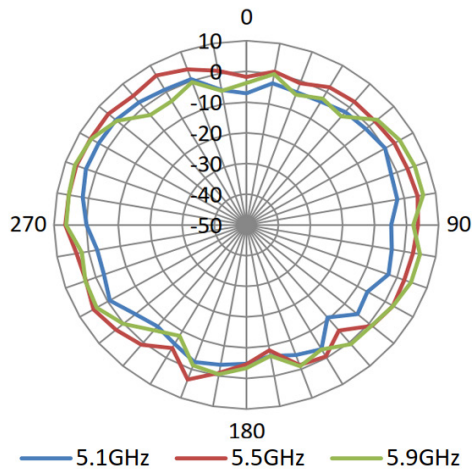
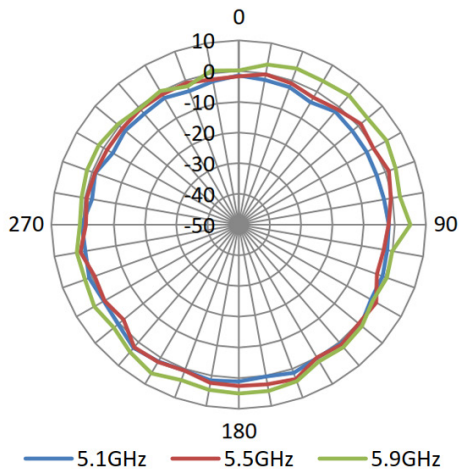

5.1 - 5.9GHz Antenna 2 - Horizontal - 90°

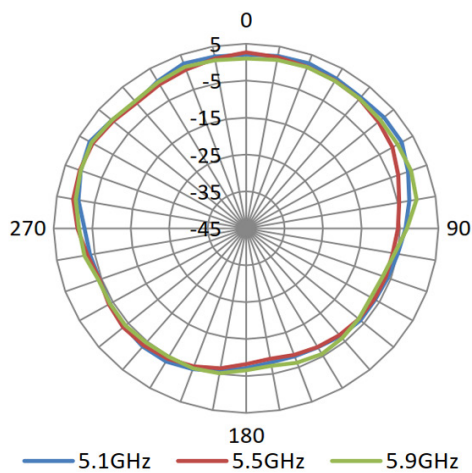
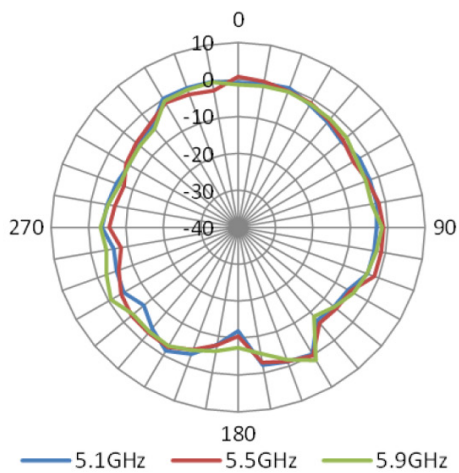



Tango 36

3 Port MiMo dual band WiFi ceiling mounted Antenna

5.1 - 5.9GHz Antenna 3 - Horizontal - 0°

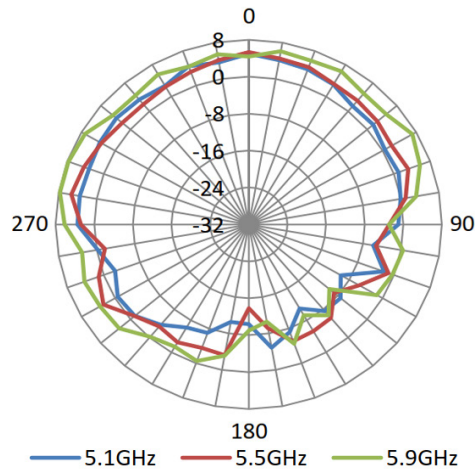
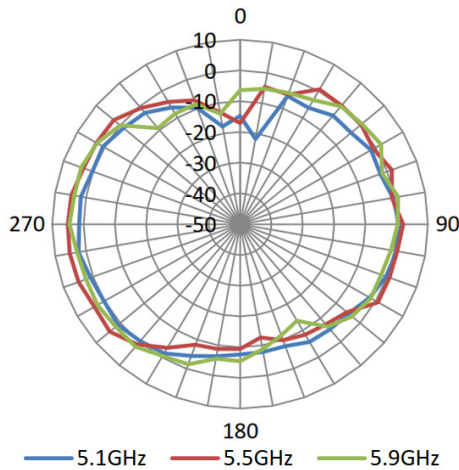

Ordering Details

Part Number	Description
TANGO36/1.5M/SMAM/RP/S/29	3 Port MiMo dual band WiFi ceiling mounted Antenna