

GlobTek, Inc. www.globtek.com 186 Veterans Drive, Northvale, NJ 07647 Tel. (201) 784-1000 Fax (201) 784-0111	Drawing Title: GT-86121-1105-W2E, ICT/ITE Power Supply, Efficiency Level: USA DOE Level VI / Eco-design Directive 2009/125/EC, (EU) 2019/1782, Case Color/Style: GlobTek Black, Wall Plug-in, Regulated Switchmode AC-DC Power Supply AC Adaptor, Input Rating: 100-240V- , 50/60Hz, Euro Plug Fixed , Output Rating: 11W, 5.0V@2.1A, Output Configuration: 1500 mm, 20/2 Cond, UL 2468, Micro USB type B without resistor, Ferrite: None, GlobTek Black, GT Cord # C46596, Pin Out: Pin 1: +V, Pin 2-4: N/C, Pin 5: Com, Blades/Input Cord: (Order Separately), Approvals: WEEE; Morocco; EAC; LPS 62368; FCC; Ukraine; CB 62368; RoHS; LPS 60950; Level VI; Double Insulation; China RoHS; CE; Conforms to 62368-1;	
	Model No. GT-86121-1105-W2E	
	Part No./Ordering No. WR9MA2100MICB-F(R6B)	Rev A

In Addition to GlobTek Inc.'s renewed ISO9001:2015 - Quality Management System Certification, GlobTek Inc. is now certified to:

ISO13485:2016 - Medical Devices Quality Management System Certification

ISO14001:2015 - Environmental Management System Certification

ISO Certificates are available online at <https://www.globtek.com/iso-certificates/>

The acceptance of this specification and use of the product described in this document indicates the acceptance and binding of the customer to Globtek TERMS AND CONDITIONS (attached to the end of this document), which supersede all other agreements, terms, and conditions (<https://en.globtek.com/terms-and-conditions/>).

The purchaser of this product (Customer) agrees that it is their sole responsibility to determine suitability/fitness of the product described in this specification for their application and to take precautions for protection against any hazards attendant to the handling and use of the product.

Footnote:

GlobTek Inc. will not be liable for the safety and performance of these power supplies/battery packs if unauthorized access and repair occurs. End user should consult applicable UL, CSA or EN standards for proper installation instruction.

Limitation of Use:

GlobTek products are intended for use with commercial, medical, and/or industrial equipment only. GlobTek product are not authorized for use as mission critical components in life support hazardous environment, nuclear or aircraft applications without prior written approval from the CEO of GlobTek Inc.

Contents of this document are subject to change without prior notice.

### Customer Approval of Specification:

Please approve, sign and send back to GlobTek so we can complete order processing.

A delay in receipt of this form will delay delivery schedule.

Company Name: _____	Customer P/N: _____
Quote Number: _____	Date: _____
Authorized Representative Name: _____	Authorized Representative Signature: _____

<b>GlobTek, Inc.</b> www.globtek.com 186 Veterans Drive, Northvale, NJ 07647 Tel. (201) 784-1000 Fax (201) 784-0111	Drawing Title: GT-86121-1105-W2E, ICT/ITE Power Supply, Efficiency Level: USA DOE Level VI / Eco-design Directive 2009/125/EC, (EU) 2019/1782, Case Color/Style: GlobTek Black, Wall Plug-in, Regulated Switchmode AC-DC Power Supply AC Adaptor, Input Rating: 100-240V- , 50/60Hz, Euro Plug Fixed , Output Rating: 11W, 5.0V@2.1A, Output Configuration: 1500 mm, 20/2 Cond, UL 2468, Micro USB type B without resistor, Ferrite: None, GlobTek Black, GT Cord # C46596, Pin Out: Pin 1: +V, Pin 2-4: N/C, Pin 5: Com, Blades/Input Cord: (Order Separately), Approvals: WEEE; Morocco; EAC; LPS 62368; FCC; Ukraine; CB 62368; RoHS; LPS 60950; Level VI; Double Insulation; China RoHS; CE; Conforms to 62368-1;	
	Model No. GT-86121-1105-W2E	
	Part No./Ordering No. WR9MA2100MICB-F(R6B)	Rev A

## REVISION HISTORY

REV	DESCRIPTION	SUB	DATE	APPROVED
A	INITIAL RELEASE	DR	11/06/2019	QA

### POWER SUPPLY INFORMATION

TYPE	Wall Plug-in
TECHNOLOGY	Regulated Switchmode AC-DC Power Supply AC Adaptor
CASE COLOR	GlobTek Black
NAMEPLATE RATED INPUT	100-240V- , 50/60Hz, 0.5A
INPUT CONFIG	Euro Plug Fixed
WATTS	11.00
VOLTS OUT	5.0
CURRENT OUT (Amps)	2.1
BLADE/CORD INCLUDED	None (Order Separately)
BLADE/CORD INSTALLED	None :(Order Separately)
INGRESS PROTECTION	IPX0
GROUNDING CONFIGURATION	(F1) Class II / Double Insulated
EFFICIENCY LEVEL	USA DOE Level VI / Eco-design Directive 2009/125/EC, (EU) 2019/1782
OUTPUT CONFIGURATION	1500 mm, 20/2 Cond, UL 2468, Micro USB type B without resistor, Ferrite: None, GlobTek Black, GT Cord # C46596
OVERMOLDED	No
OUTPUT CONNECTOR GENDER	Male
CONNECTOR PIN OUT	Pin 1: +V, Pin 2-4: N/C, Pin 5: Com
LABEL SPECS	Standard GT,L-1186
SPECIAL BARCODE LABEL MATERIAL	No
PACK SPEC	Standard DT, Cellular packaging
USER MANUAL	

GlobTek, Inc. www.globtek.com 186 Veterans Drive, Northvale, NJ 07647 Tel. (201) 784-1000 Fax (201) 784-0111	Drawing Title: GT-86121-1105-W2E, ICT/ITE Power Supply, Efficiency Level: USA DOE Level VI / Eco-design Directive 2009/125/EC, (EU) 2019/1782, Case Color/Style: GlobTek Black, Wall Plug-in, Regulated Switchmode AC-DC Power Supply AC Adaptor, Input Rating: 100-240V- , 50/60Hz, Euro Plug Fixed , Output Rating: 11W, 5.0V@2.1A, Output Configuration: 1500 mm, 20/2 Cond, UL 2468, Micro USB type B without resistor, Ferrite: None, GlobTek Black, GT Cord # C46596, Pin Out: Pin 1: +V, Pin 2-4: N/C, Pin 5: Com, Blades/Input Cord: (Order Separately), Approvals: WEEE; Morocco; EAC; LPS 62368; FCC; Ukraine; CB 62368; RoHS; LPS 60950; Level VI; Double Insulation; China RoHS; CE; Conforms to 62368-1;	
	Model No. GT-86121-1105-W2E	
	Part No./Ordering No. WR9MA2100MICB-F(R6B)	Rev A

Notes/Modifications/Customizations (notes in this section supersede the values shown in the standard spec)

DIMENSIONS ARE IN MM UNLESS SPECIFIED OTHERWISE

GloTek, Inc. www.globtek.com 186 Veterans Drive, Northvale, NJ 07647 Tel. (201) 784-1000 Fax (201) 784-0111	Drawing Title: GT-86121-1105-W2E, ICT/ITE Power Supply, Efficiency Level: USA DOE Level VI / Eco-design Directive 2009/125/EC, (EU) 2019/1782, Case Color/Style: GlobTek Black, Wall Plug-in, Regulated Switchmode AC-DC Power Supply AC Adaptor, Input Rating: 100-240V- , 50/60Hz, Euro Plug Fixed , Output Rating: 11W, 5.0V@2.1A, Output Configuration: 1500 mm, 20/2 Cond, UL 2468, Micro USB type B without resistor, Ferrite: None, GlobTek Black, GT Cord # C46596, Pin Out: Pin 1: +V, Pin 2-4: N/C, Pin 5: Com, Blades/Input Cord: (Order Separately), Approvals: WEEE; Morocco; EAC; LPS 62368; FCC; Ukraine; CB 62368; RoHS; LPS 60950; Level VI; Double Insulation; China RoHS; CE; Conforms to 62368-1;	
	Model No. GT-86121-1105-W2E	
	Part No./Ordering No. WR9MA2100MICB-F(R6B)	Rev A

## ELECTRICAL SPECIFICATIONS

### ELECTRICAL SPECIFICATIONS:

01. Input Voltage: Specified 90-264 Vac, Nameplate rated: 100-240Vac
02. Input Frequency: Specified 47-63 Hz, Nameplate rated 50-60Hz
03. Output Regulation: +/- 5%
04. Ripple and Noise (Vp-p): 200 mVp-p maximum, At 20 MHz, and output parallel with 0.1uF & 47uF capacitors to ground. Temperature at 25 °C, and nominal input voltage
05. Efficiency: Compliant with Efficiency Level VI and ErP European Commission's Ecodesign Directive (2005/32/EC) / CoC Tier 2 Compliant
06. No Load Standby Power: <0.075W @ 230Vac
07. Turn-ON Delay: 3 Seconds maximum at nominal input voltage
08. Rise Time: 100mS maximum at nominal input voltage

### B) PROTECTION

01. Over-Voltage
02. Over current protection with auto-recovery function
03. Short Circuit: Short circuit protection is to be included in the construction of the adaptor. The adaptor is designed to withstand continuous current of a short circuit on the output. The adaptor will be short circuit tolerant for an indefinite period.

### C) SAFETY

01. Dielectric Withstand Voltage: 3000VAC 10mA 1minute or 4242VDC 10mA 1minute from primary to secondary
02. Leakage current: 0.25mA maximum, at nominal AC input voltage and frequency

### D) EMC

01. Emissions, per EN 55032, EN 61000-6-3, EN 61000-6-4
  - Conducted Emissions: Class B, FCC Part 15, Class B
  - Radiated Emissions: Class B, FCC Part 15, Class B
02. Line Frequency Harmonics EN61000-3-2, Class A
03. Voltage Fluctuations/Flicker EN61000-3-3
04. Immunity, per EN 55024, EN 61000-6-1, EN 61000-6-2
  - Static Discharge Immunity EN61000-4-2, 4kV Contact Discharge, 8kV air discharge
  - Radiated RF Immunity EN61000-4-3, 3V/m 80-1000MHz, 80% 1KHz AM.
  - EFT/Burst Immunity EN61000-4-4, 1kV/100kHz.
  - Line Surge Immunity EN61000-4-5, 1kV differential, 2kV common-mode
  - Conducted RF Immunity EN61000-4-6, 3Vrms, 80% 1KHz AM
  - Power Frequency Magnetic Field Immunity EN61000-4-8, 1A/m
  - Voltage Dip Immunity EN61000-4-11, Criteria

### E) OTHER:

01. MTBF: 200,000 Hours @ 25°C ambient temperature
02. Operating Temperature: 0°C to 50°C ambient temperature (RFP7139)
03. Humidity: 5% to 90% relative humidity
04. Storage Temperature: -20°C to 60°C
05. Cooling: natural convection cooling
06. ROHS 2: Complies with EU 2011/65/EU and China SJ/T 11363-2006

### F) ENCLOSURE

#### PROPRIETARY INFORMATION

PROPRIETARY OF GLOBTEK, INC. ANY REPRODUCTION, DISCLOSURE OR USE OF THIS DRAWING, IN WHOLE OR IN PART, IS HEREBY PROHIBITED EXCEPT AS SPECIFIED IN WRITING BY GLOBTEK, INC. © GlobTek, Inc. 2019 - 2023

GlobTek, Inc. www.globtek.com 186 Veterans Drive, Northvale, NJ 07647 Tel. (201) 784-1000 Fax (201) 784-0111	Drawing Title: GT-86121-1105-W2E, ICT/ITE Power Supply, Efficiency Level: USA DOE Level VI / Eco-design Directive 2009/125/EC, (EU) 2019/1782, Case Color/Style: GlobTek Black, Wall Plug-in, Regulated Switchmode AC-DC Power Supply AC Adaptor, Input Rating: 100-240V- , 50/60Hz, Euro Plug Fixed , Output Rating: 11W, 5.0V@2.1A, Output Configuration: 1500 mm, 20/2 Cond, UL 2468, Micro USB type B without resistor, Ferrite: None, GlobTek Black, GT Cord # C46596, Pin Out: Pin 1: +V, Pin 2-4: N/C, Pin 5: Com, Blades/Input Cord: (Order Separately), Approvals: WEEE; Morocco; EAC; LPS 62368; FCC; Ukraine; CB 62368; RoHS; LPS 60950; Level VI; Double Insulation; China RoHS; CE; Conforms to 62368-1;	
	Model No. GT-86121-1105-W2E	
	Part No./Ordering No. WR9MA2100MICB-F(R6B)	Rev A

- 01. Housing: High impact plastic, 94V0 polycarbonate, non-vented
- 02. Markings: Label and/or Pad Printed and/or Molded in the case

TO ADDRESS SYSTEM-LEVEL EMI CONCERNS, FERRITE CHOKES/BEADS MAY BE ADDED/REVISED UPON REQUEST. A SAMPLE KIT OF GLOBTEK'S STANDARD FERRITES IS AVAILABLE UNDER GLOBTEK P/N: EMI-MITIGATION-KIT1

FOR ADDITIONAL INFORMATION, PLEASE READ OUR WHITE PAPER AT:

<https://en.globtek.com/technical-articles/ferrite-kit-radiated-emi-suppression-kit-for-globtek-power-supplies-cable-assemblies>

INGRESS PROTECTION: IPX0

GlobTek, Inc.  
 www.globtek.com  
 186 Veterans Drive,  
 Northvale, NJ 07647  
 Tel. (201) 784-1000  
 Fax (201) 784-0111

Drawing Title: GT-86121-1105-W2E, ICT/ITE Power Supply, Efficiency Level: USA DOE Level VI / Eco-design Directive 2009/125/EC, (EU) 2019/1782, Case Color/Style: GlobTek Black, Wall Plug-in, Regulated Switchmode AC-DC Power Supply AC Adaptor, Input Rating: 100-240V- , 50/60Hz, Euro Plug Fixed , Output Rating: 11W, 5.0V@2.1A, Output Configuration: 1500 mm, 20/2 Cond, UL 2468, Micro USB type B without resistor, Ferrite: None, GlobTek Black, GT Cord # C46596, Pin Out: Pin 1: +V, Pin 2-4: N/C, Pin 5: Com, Blades/Input Cord: (Order Separately), Approvals: WEEE; Morocco; EAC; LPS 62368; FCC; Ukraine; CB 62368; RoHS; LPS 60950; Level VI; Double Insulation; China RoHS; CE; Conforms to 62368-1;

Model No. GT-86121-1105-W2E

Part No./Ordering No. WR9MA2100MICB-F(R6B)

Rev A

3D File Download [https://www.globtek.com/file/dl/gt-86121-wwwv\\_v-w2e\\_asm.stp](https://www.globtek.com/file/dl/gt-86121-wwwv_v-w2e_asm.stp)

Mechanical drawing

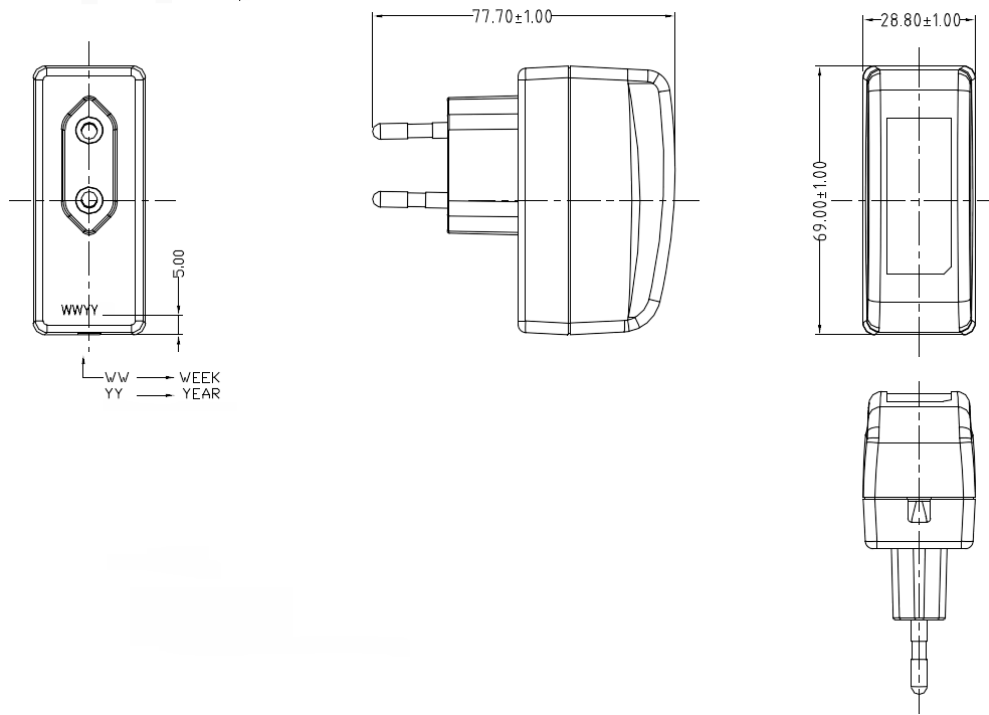

GlobTek, Inc.  
 www.globtek.com  
 186 Veterans Drive,  
 Northvale, NJ 07647  
 Tel. (201) 784-1000  
 Fax (201) 784-0111

Drawing Title: GT-86121-1105-W2E, ICT/ITE Power Supply, Efficiency Level: USA DOE Level VI / Eco-design Directive 2009/125/EC, (EU) 2019/1782, Case Color/Style: GlobTek Black, Wall Plug-in, Regulated Switchmode AC-DC Power Supply AC Adaptor, Input Rating: 100-240V- , 50/60Hz, Euro Plug Fixed , Output Rating: 11W, 5.0V@2.1A, Output Configuration: 1500 mm, 20/2 Cond, UL 2468, Micro USB type B without resistor, Ferrite: None, GlobTek Black, GT Cord # C46596, Pin Out: Pin 1: +V, Pin 2-4: N/C, Pin 5: Com, Blades/Input Cord: (Order Separately), Approvals: WEEE; Morocco; EAC; LPS 62368; FCC; Ukraine; CB 62368; RoHS; LPS 60950; Level VI; Double Insulation; China RoHS; CE; Conforms to 62368-1;

Model No. GT-86121-1105-W2E  
 Part No./Ordering No. WR9MA2100MICB-F(R6B) Rev A

DERATING CURVE

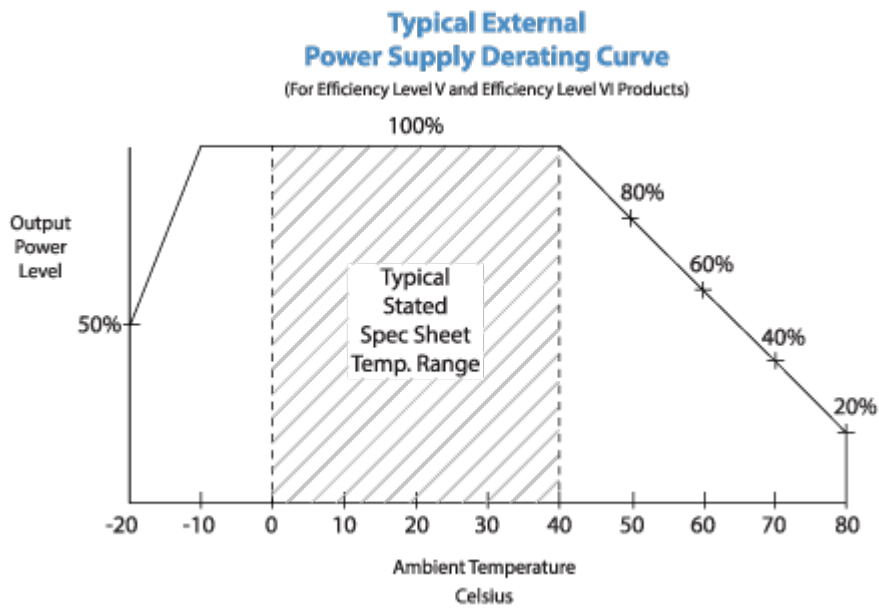

GlobTek, Inc.  
 www.globtek.com  
 186 Veterans Drive,  
 Northvale, NJ 07647  
 Tel. (201) 784-1000  
 Fax (201) 784-0111

Drawing Title: GT-86121-1105-W2E, ICT/ITE Power Supply, Efficiency Level: USA DOE Level VI / Eco-design Directive 2009/125/EC, (EU) 2019/1782, Case Color/Style: GlobTek Black, Wall Plug-in, Regulated Switchmode AC-DC Power Supply AC Adaptor, Input Rating: 100-240V- , 50/60Hz, Euro Plug Fixed , Output Rating: 11W, 5.0V@2.1A, Output Configuration: 1500 mm, 20/2 Cond, UL 2468, Micro USB type B without resistor, Ferrite: None, GlobTek Black, GT Cord # C46596, Pin Out: Pin 1: +V, Pin 2-4: N/C, Pin 5: Com, Blades/Input Cord: (Order Separately), Approvals: WEEE; Morocco; EAC; LPS 62368; FCC; Ukraine; CB 62368; RoHS; LPS 60950; Level VI; Double Insulation; China RoHS; CE; Conforms to 62368-1;

Model No. GT-86121-1105-W2E

Part No./Ordering No. WR9MA2100MICB-F(R6B)

Rev A

### INPUT CONFIGURATION

(F1) Class II / Double Insulated

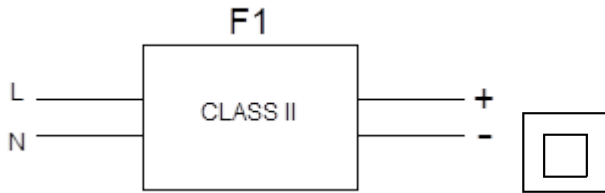

[Alternate grounding configurations](#) available upon request.

Blades/Cord Included:None:(Order Separately)

Blades/Cord Installed:None:(Order Separately)

European CEE 7/16 configuration:EN 50075 Europlug 2 PIN

The prongs of the Europlug are 19 mm long. They consist of a 9 mm long conductive tip of 4 mm diameter with a rounded ending, followed by a 10 mm long flexible insulated shaft of not more than 3.8 mm diameter. The two prongs are not exactly parallel and converge slightly; their centres are 19 mm apart at the tip and 18.6 mm apart at the base. The elasticity of the converging prongs provides sufficient contact force for the Europlug's current rating with a variety of socket-hole arrangements. The entire plug is 35.3 mm wide and 13.7 mm high, and must not exceed these dimensions within 18 mm behind its front plane (this allows for the recesses on many European socket types). The left and right side of the plug are formed by surfaces that are at 45° relative to the horizontal plan.

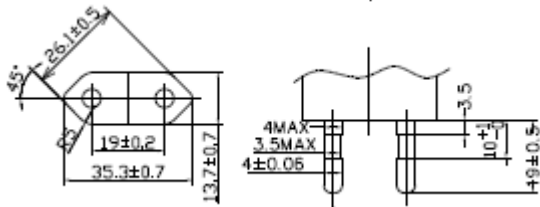



<b>GlobTek, Inc.</b> www.globtek.com 186 Veterans Drive, Northvale, NJ 07647 Tel. (201) 784-1000 Fax (201) 784-0111	Drawing Title: GT-86121-1105-W2E, ICT/ITE Power Supply, Efficiency Level: USA DOE Level VI / Eco-design Directive 2009/125/EC, (EU) 2019/1782, Case Color/Style: GlobTek Black, Wall Plug-in, Regulated Switchmode AC-DC Power Supply AC Adaptor, Input Rating: 100-240V- , 50/60Hz, Euro Plug Fixed , Output Rating: 11W, 5.0V@2.1A, Output Configuration: 1500 mm, 20/2 Cond, UL 2468, Micro USB type B without resistor, Ferrite: None, GlobTek Black, GT Cord # C46596, Pin Out: Pin 1: +V, Pin 2-4: N/C, Pin 5: Com, Blades/Input Cord: (Order Separately), Approvals: WEEE; Morocco; EAC; LPS 62368; FCC; Ukraine; CB 62368; RoHS; LPS 60950; Level VI; Double Insulation; China RoHS; CE; Conforms to 62368-1;	
	Model No. GT-86121-1105-W2E	
	Part No./Ordering No. WR9MA2100MICB-F(R6B)	Rev A

**OUTPUT CORD AND CONNECTOR: MICUSB/C46596**

ACTUAL CONNECTORS, OVERMOLDS, FERRITES MAY VARY SLIGHTLY FROM THE PICTURE BELOW

CABLE TYPE	UL 2468
CABLE LENGTH (mm)	1500
CABLE TOLERANCE (mm)	+150 -0
WIRE GAUGE (AWG)	20
CONDUCTORS	2
HANK DIMENSION (mm)	80mm +/-10
CABLE / CONNECTOR OVERMOLD COLOR	GlobTek Black
FERRITE TYPE AND DIMENSION	None
FERRITE NUMBER OF TURNS <a href="#">(Definition)</a>	N/A
FERRITE DIMENSION FROM STRAIN RELIEF	N/A
FERRITE DIMENSION FROM PLUG	N/A
PLUG TYPE	Micro USB type B without resistor
OUTPUT CONNECTOR GENDER	Male
OVERMOLDED	No
OVER MOLD ORIENTATION	Straight
CONNECTOR PIN OUT	Pin 1: +V, Pin 2-4: N/C, Pin 5: Com

**PINOUT:**

- PIN 1: +5V
- PIN 2: N/C
- PIN 3: N/C
- PIN 4: N/C
- PIN 5: GND

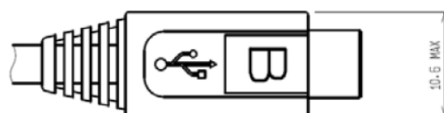
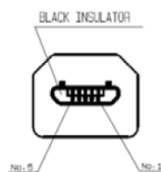

GlobTek, Inc. www.globtek.com 186 Veterans Drive, Northvale, NJ 07647 Tel. (201) 784-1000 Fax (201) 784-0111	Drawing Title: GT-86121-1105-W2E, ICT/ITE Power Supply, Efficiency Level: USA DOE Level VI / Eco-design Directive 2009/125/EC, (EU) 2019/1782, Case Color/Style: GlobTek Black, Wall Plug-in, Regulated Switchmode AC-DC Power Supply AC Adaptor, Input Rating: 100-240V- , 50/60Hz, Euro Plug Fixed , Output Rating: 11W, 5.0V@2.1A, Output Configuration: 1500 mm, 20/2 Cond, UL 2468, Micro USB type B without resistor, Ferrite: None, GlobTek Black, GT Cord # C46596, Pin Out: Pin 1: +V, Pin 2-4: N/C, Pin 5: Com, Blades/Input Cord: (Order Separately), Approvals: WEEE; Morocco; EAC; LPS 62368; FCC; Ukraine; CB 62368; RoHS; LPS 60950; Level VI; Double Insulation; China RoHS; CE; Conforms to 62368-1;	
	Model No. GT-86121-1105-W2E	
	Part No./Ordering No. WR9MA2100MICB-F(R6B)	Rev A

ADDITIONAL OUTPUT PLUG OPTIONS ARE AVAILABLE AT <https://www.globtek.com/connectors/>  
STANDARD PLUGS AND CONNECTORS CAN BE SEEN ONLINE AT <https://www.globtek.com/connectors/>  
CALCULATE VOLTAGE REGULATION/DROP WITH OUR ONLINE CALCULATOR: <https://en.globtek.com/output-cable-regulation-calculator/>

<p>GlobTek, Inc.  www.globtek.com  186 Veterans Drive,  Northvale, NJ 07647  Tel. (201) 784-1000  Fax (201) 784-0111</p>	<p>Drawing Title: GT-86121-1105-W2E, ICT/ITE Power Supply, Efficiency Level: USA DOE Level VI / Eco-design Directive 2009/125/EC, (EU) 2019/1782, Case Color/Style: GlobTek Black, Wall Plug-in, Regulated Switchmode AC-DC Power Supply AC Adaptor, Input Rating: 100-240V- , 50/60Hz, Euro Plug Fixed , Output Rating: 11W, 5.0V@2.1A, Output Configuration: 1500 mm, 20/2 Cond, UL 2468, Micro USB type B without resistor, Ferrite: None, GlobTek Black, GT Cord # C46596, Pin Out: Pin 1: +V, Pin 2-4: N/C, Pin 5: Com, Blades/Input Cord: (Order Separately), Approvals: WEEE; Morocco; EAC; LPS 62368; FCC; Ukraine; CB 62368; RoHS; LPS 60950; Level VI; Double Insulation; China RoHS; CE; Conforms to 62368-1;</p>
	<p>Model No. GT-86121-1105-W2E</p>
	<p>Part No./Ordering No. WR9MA2100MICB-F(R6B)</p>
	<p>Rev A</p>

**OUTPUT CONNECTOR HOOK UP**

TO ADDRESS SYSTEM-LEVEL EMI CONCERNS, FERRITE CHOKES/BEADS MAY BE ADDED/REVISED UPON REQUEST. A SAMPLE KIT OF GLOBTEK'S STANDARD FERRITES IS AVAILABLE UNDER GLOBTEK P/N: EMI-MITIGATION-KIT1

FOR ADDITIONAL INFORMATION, PLEASE READ OUR WHITE PAPER AT:

<https://en.globtek.com/technical-articles/ferrite-kit-radiated-emi-suppression-kit-for-globtek-power-supplies-cable-assemblies>

<b>GlobTek, Inc.</b> www.globtek.com 186 Veterans Drive, Northvale, NJ 07647 Tel. (201) 784-1000 Fax (201) 784-0111	Drawing Title: GT-86121-1105-W2E, ICT/ITE Power Supply, Efficiency Level: USA DOE Level VI / Eco-design Directive 2009/125/EC, (EU) 2019/1782, Case Color/Style: GlobTek Black, Wall Plug-in, Regulated Switchmode AC-DC Power Supply AC Adaptor, Input Rating: 100-240V- , 50/60Hz, Euro Plug Fixed , Output Rating: 11W, 5.0V@2.1A, Output Configuration: 1500 mm, 20/2 Cond, UL 2468, Micro USB type B without resistor, Ferrite: None, GlobTek Black, GT Cord # C46596, Pin Out: Pin 1: +V, Pin 2-4: N/C, Pin 5: Com, Blades/Input Cord: (Order Separately), Approvals: WEEE; Morocco; EAC; LPS 62368; FCC; Ukraine; CB 62368; RoHS; LPS 60950; Level VI; Double Insulation; China RoHS; CE; Conforms to 62368-1;	
	Model No. GT-86121-1105-W2E	
	Part No./Ordering No. WR9MA2100MICB-F(R6B)	Rev A

**LABEL:L-1186**

LABEL P/N	Standard GT
MATERIAL	Flat Thermal Transfer, Imprintable, Polyester Label and/or Pad Printed and/or Molded, and/or Laser Engraved in the case
BACKGROUND COLOR	Black if housing is Black, White or Silver if housing is White or Gray.
TEXT COLOR	White or Silver if label is Black Background for Black housing. Black if label is White or Silver background and Housing is White or Gray.
LABEL WIDTH (mm)	39.7
LABEL HEIGHT (mm)	16.2
SPECIAL BARCODE LABEL MATERIAL	No

Below is the minimum information which will appear on the label. NOTE: in the logo area additional/actual positioning of symbols and text is subjected to change as per agency updates/requirements or additional model approvals become available.  
 Regulatory certifications/label markings may be in logo area on the label or molded into the case housing outside the label area.  
 Information will be shown via label and/or pad printed and/or molded and/or laser engraved in the case. \* Date code markings at GlobTek option

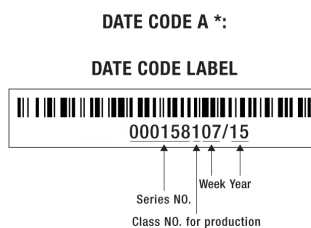

or  
**DATE CODE B \***  
 WWYY  
 WW = WEEK  
 YY = YEAR

A=ICT/ITE Power Supply  
 B=P/N: (料号) WR9MA2100MICB-F(R6B)  
 C=Model (型号) GT-86121-1105-W2E  
 D=Input (输入)100-240V- , 50/60Hz, 0.5A  
 E=Output (输出)5.0 V --- 2.1 A, 11.00W

<b>GlobTek, Inc.</b> www.globtek.com 186 Veterans Drive, Northvale, NJ 07647 Tel. (201) 784-1000 Fax (201) 784-0111	Drawing Title: GT-86121-1105-W2E, ICT/ITE Power Supply, Efficiency Level: USA DOE Level VI / Eco-design Directive 2009/125/EC, (EU) 2019/1782, Case Color/Style: GlobTek Black, Wall Plug-in, Regulated Switchmode AC-DC Power Supply AC Adaptor, Input Rating: 100-240V- , 50/60Hz, Euro Plug Fixed , Output Rating: 11W, 5.0V@2.1A, Output Configuration: 1500 mm, 20/2 Cond, UL 2468, Micro USB type B without resistor, Ferrite: None, GlobTek Black, GT Cord # C46596, Pin Out: Pin 1: +V, Pin 2-4: N/C, Pin 5: Com, Blades/Input Cord: (Order Separately), Approvals: WEEE; Morocco; EAC; LPS 62368; FCC; Ukraine; CB 62368; RoHS; LPS 60950; Level VI; Double Insulation; China RoHS; CE; Conforms to 62368-1;	
	Model No. GT-86121-1105-W2E	
	Part No./Ordering No. WR9MA2100MICB-F(R6B)	Rev A

AGENCY ONLINE DOCUMENTS	<a href="http://www.globtek.info/certs/GT-86121-WVVV-W2/">http://www.globtek.info/certs/GT-86121-WVVV-W2/</a>
CE EC-Declaration for Medical	<a href="#">Contact GlobTek for more information</a>
CE EC-Declaration for Industrial/Commercial/ITE	<a href="http://globtek.force.com/models/ec_declaration_product?id=01t3a000004e1un&amp;i=2">http://globtek.force.com/models/ec_declaration_product?id=01t3a000004e1un&amp;i=2</a>
CE EC-Declaration for Household	<a href="#">Contact GlobTek for more information</a>
UKCA-Declaration for Medical	<a href="#">Contact GlobTek for more information</a>
UKCA-Declaration for Industrial/Commercial/ITE	<a href="http://globtek.force.com/models/ukca_declaration_product?id=01t3a000004e1un&amp;i=2">http://globtek.force.com/models/ukca_declaration_product?id=01t3a000004e1un&amp;i=2</a>
UKCA-Declaration for Household	<a href="#">Contact GlobTek for more information</a>
Morocco SDoC Declaration	<a href="https://globtek.secure.force.com/models/Morocco_SDoC_Declaration?id=a0Oa000000PSQ1tEAH">https://globtek.secure.force.com/models/Morocco_SDoC_Declaration?id=a0Oa000000PSQ1tEAH</a>
RoHS/RoHS3 Declaration	<a href="https://www.globtek.com/pdf/rohs_cert/01t3a000004e1unAAA">https://www.globtek.com/pdf/rohs_cert/01t3a000004e1unAAA</a>
REACH Declaration	<a href="https://www.globtek.com/pdf/iso_certificates/REACH.pdf">https://www.globtek.com/pdf/iso_certificates/REACH.pdf</a>
Conflict Minerals Declaration	<a href="https://www.globtek.com/pdf/conflict-minerals.pdf">https://www.globtek.com/pdf/conflict-minerals.pdf</a>
Prop 65 Statement	<a href="https://en.globtek.com/prop-65-statement.pdf">https://en.globtek.com/prop-65-statement.pdf</a>

IPXY rating is based on 3rd party testing and customers should check suitability and test system level IPXY rating before ordering.

## Regulatory Certifications/Label Markings

Below follows a link to the latest regulatory certifications and marks for this specific product. National standards as well as certification schemes are constantly changing and so is the set of certification marks and symbols applicable to this product. Various standards, marks and symbols, and certificates are subject to change at any time without notice.

Additional standards or unique country certifications are available upon request. Please contact Globtek to request a quotation.

LATEST PRODUCT/MODEL CERTIFICATIONS:	<a href="https://www.globtek.com/datasheet/w71168">https://www.globtek.com/datasheet/w71168</a>
AGENCY ONLINE DOCUMENTS	<a href="http://www.globtek.info/certs/GT-86121-WVVV-W2/">http://www.globtek.info/certs/GT-86121-WVVV-W2/</a>



(F1) Class II / Double Insulated



Pin 1: +V, Pin 2-4: N/C, Pin 5: Com

<b>GlobTek, Inc.</b> www.globtek.com 186 Veterans Drive, Northvale, NJ 07647 Tel. (201) 784-1000 Fax (201) 784-0111	Drawing Title: GT-86121-1105-W2E, ICT/ITE Power Supply, Efficiency Level: USA DOE Level VI / Eco-design Directive 2009/125/EC, (EU) 2019/1782, Case Color/Style: GlobTek Black, Wall Plug-in, Regulated Switchmode AC-DC Power Supply AC Adaptor, Input Rating: 100-240V- , 50/60Hz, Euro Plug Fixed , Output Rating: 11W, 5.0V@2.1A, Output Configuration: 1500 mm, 20/2 Cond, UL 2468, Micro USB type B without resistor, Ferrite: None, GlobTek Black, GT Cord # C46596, Pin Out: Pin 1: +V, Pin 2-4: N/C, Pin 5: Com, Blades/Input Cord: (Order Separately), Approvals: WEEE; Morocco; EAC; LPS 62368; FCC; Ukraine; CB 62368; RoHS; LPS 60950; Level VI; Double Insulation; China RoHS; CE; Conforms to 62368-1;	
	Model No. GT-86121-1105-W2E	
	Part No./Ordering No. WR9MA2100MICB-F(R6B)	Rev A

## PACKAGING

Packing Spec P/N:	Standard DT, Cellular packaging
Box Qty	90
Gift Box Size (mm):	90*48*82
Gift Box Color:	White
Master Carton Size (mm):	470 x 310 x 278
Master Carton Cubic Volume (m³):	0.04
Master GW (Kg):	15.6 kg
BLADES INCLUDED:	None: (Order Separately)
BLADE/CORD INSTALLED:	None: (Order Separately)
USER MANUAL*:	
USER MANUAL WEB LINK:	

\* This specification sheet is considered the user manual for all applications. It is expected that the buyer of this product will use it to formulate their own user manual for their end product and a user manual specifically for the power adapter is not usually required. If a user manual is not specifically listed above then none will be provided with this unit.

If specific packaging is required, this section must specify all requirements and note "no exceptions". If this section does not specify packaging, it is subject to change without notice at GlobTek's discretion.

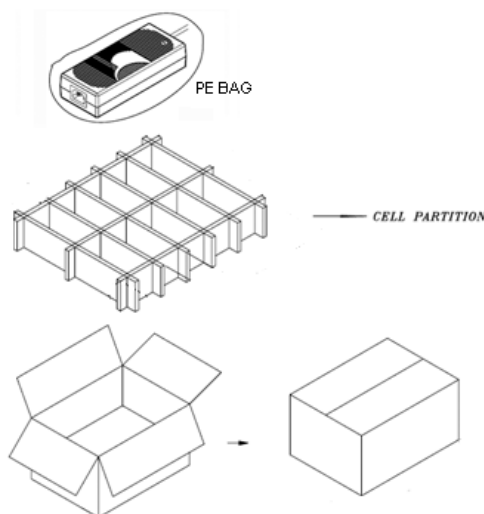

GlobTek, Inc. www.globtek.com 186 Veterans Drive, Northvale, NJ 07647 Tel. (201) 784-1000 Fax (201) 784-0111	Drawing Title: GT-86121-1105-W2E, ICT/ITE Power Supply, Efficiency Level: USA DOE Level VI / Eco-design Directive 2009/125/EC, (EU) 2019/1782, Case Color/Style: GlobTek Black, Wall Plug-in, Regulated Switchmode AC-DC Power Supply AC Adaptor, Input Rating: 100-240V- , 50/60Hz, Euro Plug Fixed , Output Rating: 11W, 5.0V@2.1A, Output Configuration: 1500 mm, 20/2 Cond, UL 2468, Micro USB type B without resistor, Ferrite: None, GlobTek Black, GT Cord # C46596, Pin Out: Pin 1: +V, Pin 2-4: N/C, Pin 5: Com, Blades/Input Cord: (Order Separately), Approvals: WEEE; Morocco; EAC; LPS 62368; FCC; Ukraine; CB 62368; RoHS; LPS 60950; Level VI; Double Insulation; China RoHS; CE; Conforms to 62368-1;	
	Model No. GT-86121-1105-W2E	
	Part No./Ordering No. WR9MA2100MICB-F(R6B)	Rev A

### INSTRUCTIONS TO THE OEM SYSTEMS ENGINEER

It is the responsibility of the OEM systems engineer to provide the end system user instructions and warnings for the use of this product in the end system.

If an input cord is required for this product, AC Mains voltage should be provided to the power supply by a power supply cord approved to the national standards of the country in which it will be used.

This product is not designed to be repaired. No serviceable parts inside. A blown internal fuse is an indication of catastrophic failure of circuit component(s). If a Failure Analysis is required for a failed power supply/battery charger, please return the damaged unit to GlobTek for an accurate determination of the root cause of the failure.

EMC Compliance of the complete OEM product, including the GlobTek power supply/battery charger needs to be verified by the OEM systems engineer.

### INSTRUCTION SHEET

N/A

<p>GlobTek, Inc.  www.globtek.com  186 Veterans Drive,  Northvale, NJ 07647  Tel. (201) 784-1000  Fax (201) 784-0111</p>	<p>Drawing Title: GT-86121-1105-W2E, ICT/ITE Power Supply, Efficiency Level: USA DOE Level VI / Eco-design Directive 2009/125/EC, (EU) 2019/1782, Case Color/Style: GlobTek Black, Wall Plug-in, Regulated Switchmode AC-DC Power Supply AC Adaptor, Input Rating: 100-240V- , 50/60Hz, Euro Plug Fixed , Output Rating: 11W, 5.0V@2.1A, Output Configuration: 1500 mm, 20/2 Cond, UL 2468, Micro USB type B without resistor, Ferrite: None, GlobTek Black, GT Cord # C46596, Pin Out: Pin 1: +V, Pin 2-4: N/C, Pin 5: Com, Blades/Input Cord: (Order Separately), Approvals: WEEE; Morocco; EAC; LPS 62368; FCC; Ukraine; CB 62368; RoHS; LPS 60950; Level VI; Double Insulation; China RoHS; CE; Conforms to 62368-1;</p>
	<p>Model No. GT-86121-1105-W2E</p>
	<p>Part No./Ordering No. WR9MA2100MICB-F(R6B) <span style="float: right;">Rev A</span></p>

