

Type BLR-708 Fuse Block 8 Pole – Regular Auto Blade



www.optifuse.com

(619) 593-5050

Specifications:

Fuse Type: Regular Auto Blade – APR, ANR Series

Max Current Rating: 15A per Circuit - 60A Max

Max Voltage: 32VDC

Material:

1. **Base:** Nylon 66 + 15% Fiber

2. **Terminals:** Brass, 0.250" [6.3mm] Quick Connect Terminals

3. **Sealer:** NBR

4. **Cover:** Polycarbonate (Transparent)

5. **Mounting Seal:** Nylon 66 + 15% Fiber

Mounting: Two (2) 5.4 mounting holes for #10 screws



Mechanical Dimensions: Inches [mm]

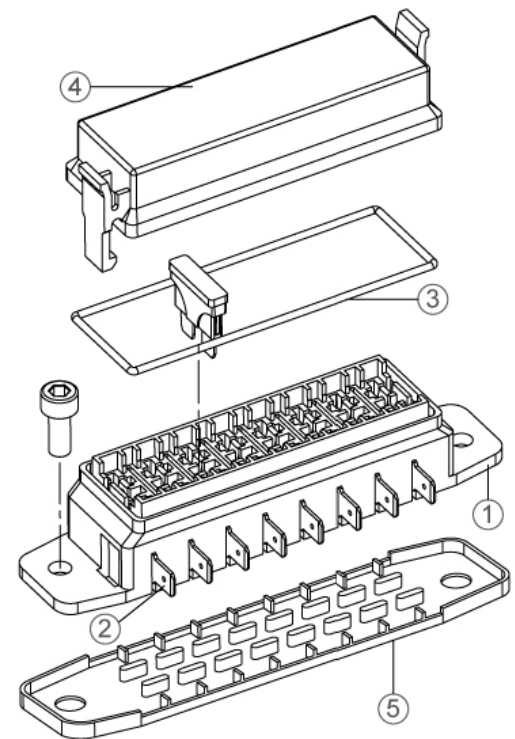
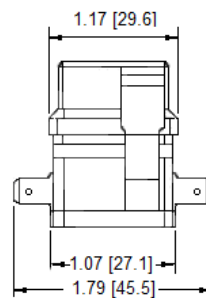
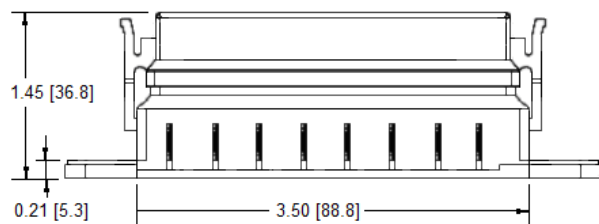
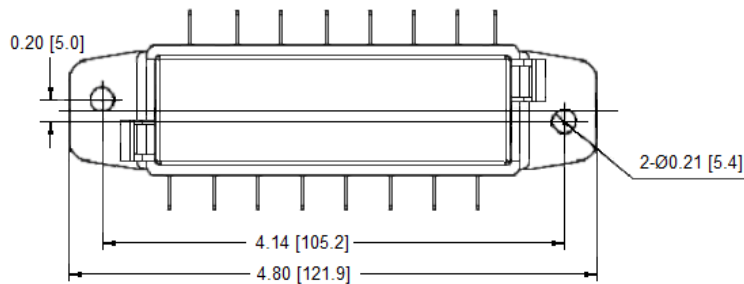

Warning:



-Operation beyond the specified maximum ratings or improper use may result in damage and possible electrical arcing and/or flame.

-Avoid contact of device with chemical solvent. Prolonged contact may damage the device performance.

Note: All specifications subject to change without notice.

Rev B 04/2018 - Page: 1/1
Code B01-01H