













Reversing contactor assembly for 3RA27 AC-3, 4 kW/400 V, 24 V DC 3-pole, Size S00 screw terminal electrical and mechanical interlock with voltage tap



product brand name	SIRIUS
product designation	Reversing contactor assembly
product type designation	3RA23
manufacturer's article number	
<ul style="list-style-type: none"> • 1 of the supplied contactor • 2 of the supplied contactor • of the supplied RH assembly kit 	3RT2016-1BB42-0CC0 3RT2016-1BB42 3RA2913-2AA2
General technical data	
size of contactor	S00
product extension auxiliary switch	Yes
shock resistance at rectangular impulse	
<ul style="list-style-type: none"> • at AC • at DC 	6,7g / 5 ms, 4,2g / 10 ms 6,7g / 5 ms, 4,2g / 10 ms
shock resistance with sine pulse	
<ul style="list-style-type: none"> • at AC • at DC 	10,5g / 5 ms, 6,6g / 10 ms 10,5g / 5 ms, 6,6g / 10 ms
mechanical service life (switching cycles)	
<ul style="list-style-type: none"> • of contactor typical • of the contactor with added auxiliary switch block typical 	10 000 000 10 000 000
reference code according to IEC 81346-2	Q
Substance Prohibitance (Date)	10/01/2009
Ambient conditions	
installation altitude at height above sea level maximum	2 000 m
ambient temperature	
<ul style="list-style-type: none"> • during operation • during storage 	-25 ... +60 °C -55 ... +80 °C
Main circuit	
number of poles for main current circuit	3
number of NO contacts for main contacts	3
number of NC contacts for main contacts	0
operating voltage at AC-3 rated value maximum	690 V
operational current at AC-3	
<ul style="list-style-type: none"> • at 400 V rated value • at 500 V rated value • at 690 V rated value 	9 A 7.7 A 6.7 A
operating power	
<ul style="list-style-type: none"> • at AC-3 — at 400 V rated value 	4 kW

— at 500 V rated value	4 kW
— at 690 V rated value	5.5 kW
● at AC-4 at 400 V rated value	4 kW
operating frequency at AC-3 maximum	750 1/h
Control circuit/ Control	
type of voltage of the control supply voltage	DC
control supply voltage 1	
● at DC rated value	24 V
closing power of magnet coil at DC	4 W
holding power of magnet coil at DC	4 W
Auxiliary circuit	
number of NC contacts for auxiliary contacts	
● per direction of rotation	1
number of NO contacts for auxiliary contacts	
● per direction of rotation	0
contact reliability of auxiliary contacts	< 1 error per 100 million operating cycles
UL/CSA ratings	
full-load current (FLA) for 3-phase AC motor	
● at 480 V rated value	7.6 A
● at 600 V rated value	9 A
yielded mechanical performance [hp] for 3-phase AC motor	
● at 200/208 V rated value	2 hp
● at 220/230 V rated value	3 hp
● at 460/480 V rated value	5 hp
● at 575/600 V rated value	7.5 hp
contact rating of auxiliary contacts according to UL	A600 / Q600
Short-circuit protection	
design of the fuse link	
● for short-circuit protection of the main circuit	
— with type of coordination 1 required	gG NH 3NA, DIAZED 5SB, NEOZED 5SE: 35 A
— with type of assignment 2 required	gG NH 3NA, DIAZED 5SB, NEOZED 5SE: 20 A
● for short-circuit protection of the auxiliary switch required	fuse gG: 10 A
Installation/ mounting/ dimensions	
mounting position	+/-180° rotation possible on vertical mounting surface; can be tilted forward and backward by +/- 22.5° on vertical mounting surface
fastening method	screw and snap-on mounting onto 35 mm standard mounting rail
height	68 mm
width	90 mm
depth	73 mm
required spacing	
● with side-by-side mounting	
— forwards	6 mm
— backwards	0 mm
— upwards	6 mm
— downwards	6 mm
— at the side	6 mm
● for grounded parts	
— forwards	6 mm
— backwards	0 mm
— upwards	6 mm
— at the side	6 mm
— downwards	6 mm
● for live parts	
— forwards	6 mm
— backwards	0 mm
— upwards	6 mm
— downwards	6 mm
— at the side	6 mm

Connections/ Terminals			
type of electrical connection <ul style="list-style-type: none"> • for main current circuit • for auxiliary and control circuit • at contactor for auxiliary contacts • of magnet coil 	screw-type terminals screw-type terminals Screw-type terminals Screw-type terminals		
type of connectable conductor cross-sections <ul style="list-style-type: none"> • for main contacts <ul style="list-style-type: none"> — solid — solid or stranded — finely stranded with core end processing • at AWG cables for main contacts 	2x (0.5 ... 1.5 mm ²), 2x (0.75 ... 2.5 mm ²), 2x 4 mm ² 2x (0,5 ... 1,5 mm ²), 2x (0,75 ... 2,5 mm ²), 2x (0,5 ... 4 mm ²) 2x (0.5 ... 1.5 mm ²), 2x (0.75 ... 2.5 mm ²) 2x (20 ... 16), 2x (18 ... 14)		
type of connectable conductor cross-sections <ul style="list-style-type: none"> • for auxiliary contacts <ul style="list-style-type: none"> — solid or stranded — finely stranded with core end processing • at AWG cables for auxiliary contacts 	2x (0.5 ... 1.5 mm ²), 2x (0.75 ... 2.5 mm ²) 2x (0,5 ... 1,5 mm ²), 2x (0,75 ... 2,5 mm ²) 2x (20 ... 16), 2x (18 ... 14)		
Safety related data			
B10 value with high demand rate according to SN 31920	1 000 000		
proportion of dangerous failures <ul style="list-style-type: none"> • with low demand rate according to SN 31920 • with high demand rate according to SN 31920 	40 % 75 %		
failure rate [FIT] with low demand rate according to SN 31920	100 FIT		
T1 value for proof test interval or service life according to IEC 61508	20 y		
protection class IP on the front according to IEC 60529	IP20		
touch protection on the front according to IEC 60529	finger-safe, for vertical contact from the front		
Communication/ Protocol			
product function bus communication	Yes		
protocol is supported AS-Interface protocol	No		
product function control circuit interface with IO link	No		
Certificates/ approvals			
General Product Approval	Declaration of Conformity		
 Confirmation    			
Test Certificates	Marine / Shipping		
Type Test Certificates/Test Report Special Test Certificate	   		
Marine / Shipping	other	Railway	Dangerous Good
  	Confirmation	Vibration and Shock	Transport Information
Further information			
Information- and Downloadcenter (Catalogs, Brochures,...) https://www.siemens.com/ic10			

Industry Mall (Online ordering system)

<https://mall.industry.siemens.com/mall/en/en/Catalog/product?mlfb=3RA2316-8XE30-1BB4>

Cax online generator

<http://support.automation.siemens.com/WW/CAXorder/default.aspx?lang=en&mlfb=3RA2316-8XE30-1BB4>

Service&Support (Manuals, Certificates, Characteristics, FAQs,...)

<https://support.industry.siemens.com/cs/ww/en/ps/3RA2316-8XE30-1BB4>

Image database (product images, 2D dimension drawings, 3D models, device circuit diagrams, EPLAN macros, ...)

http://www.automation.siemens.com/bilddb/cax_de.aspx?mlfb=3RA2316-8XE30-1BB4&lang=en

Characteristic: Tripping characteristics, I^t, Let-through current

<https://support.industry.siemens.com/cs/ww/en/ps/3RA2316-8XE30-1BB4/char>

Further characteristics (e.g. electrical endurance, switching frequency)

<http://www.automation.siemens.com/bilddb/index.aspx?view=Search&mlfb=3RA2316-8XE30-1BB4&objecttype=14&gridview=view1>

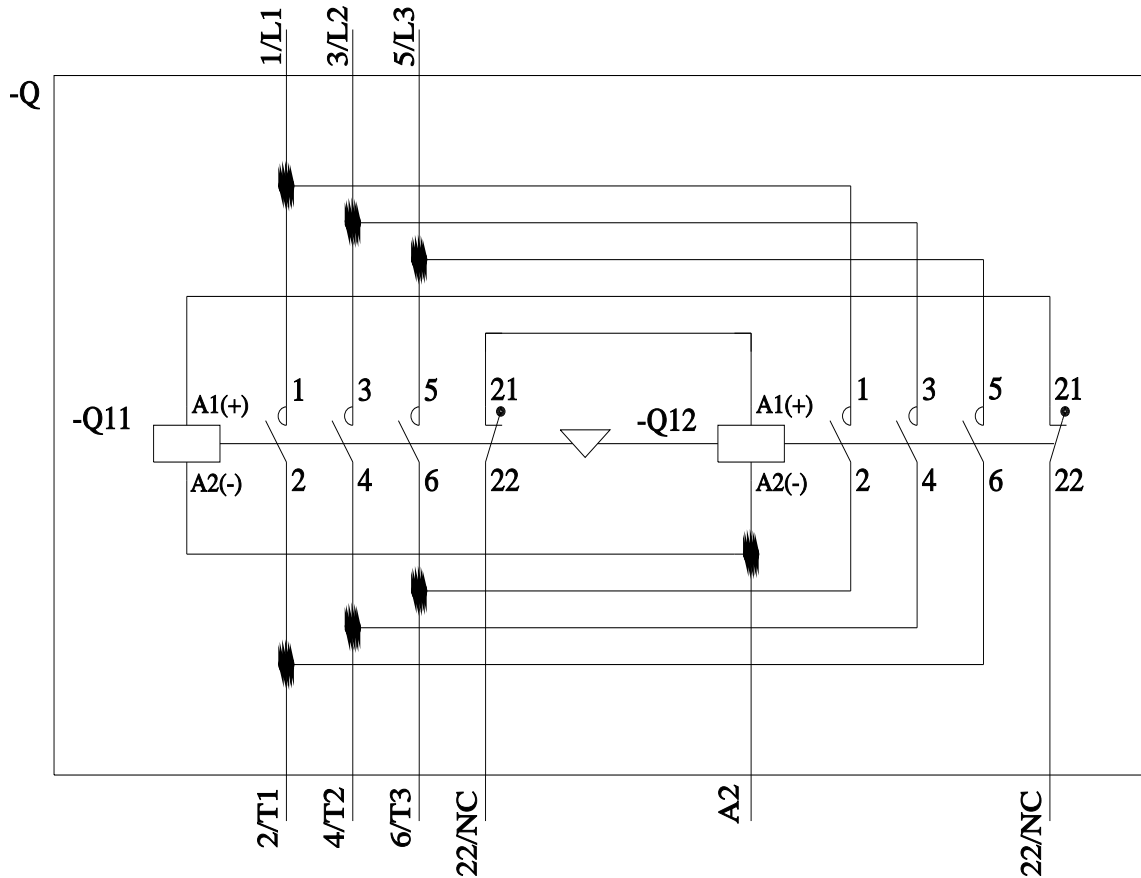

last modified:

2/8/2022