

## ALKALINE-MANGANESE DIOXIDE BATTERY

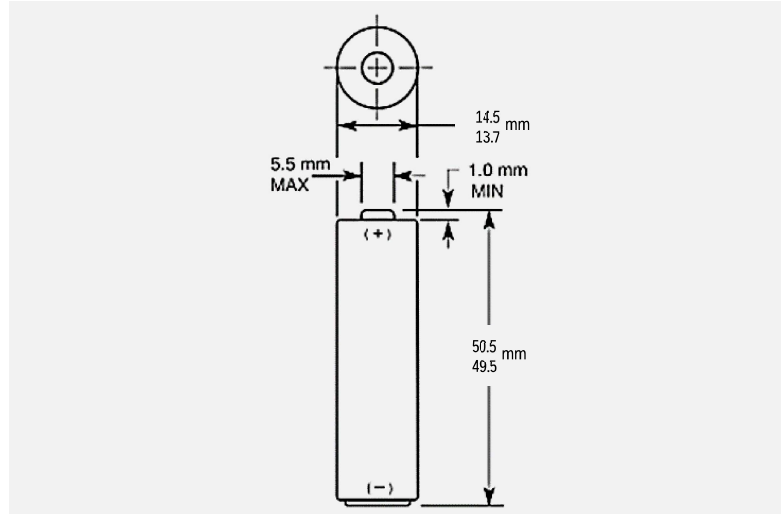

Size: AA (LR6) PX1500



Dimensions shown are IEC standards

### KEY FEATURES

- Reliable Performance
- Excellent resistance to corrosion
- Designed to meet all major quality, safety and environmental standards:
  - Safety: IEC 60086-5
  - ANSI C 18.1M, Part-2
  - EU Battery Directive
  - Quality: ISO 14001 and 9001, Duracell World Class Continuous Improvement Program

### TYPICAL APPLICATIONS

- Medical Devices
- Security Cameras
- Soap Dispensers
- Electronic Door Locks
- Window Blinds/Shades

### ELECTRICAL CHARACTERISTICS

- Nominal capacity (25 mA Cont., .8V cut-off) 3,112 mAh
- Typical Voltage (at + 20 °C) 1.5 V
- AC Impedance @ 1kHz 68 mΩ

### PHYSICAL CHARACTERISTICS

- Typical weight 24.3 g (0.9 oz)
- Typical volume 8.4 cm<sup>3</sup> (0.5 in<sup>3</sup>)
- Terminals Flat

### OPERATING & STORAGE CONDITIONS

- Operating temperature range -20°C to 54°C (-4°F to 130°F)
- Recommended Storage (storage area should be clean, cool, dry and ventilated) 5°C to 30°C (41°F to 86°F)

TYPICAL PERFORMANCE

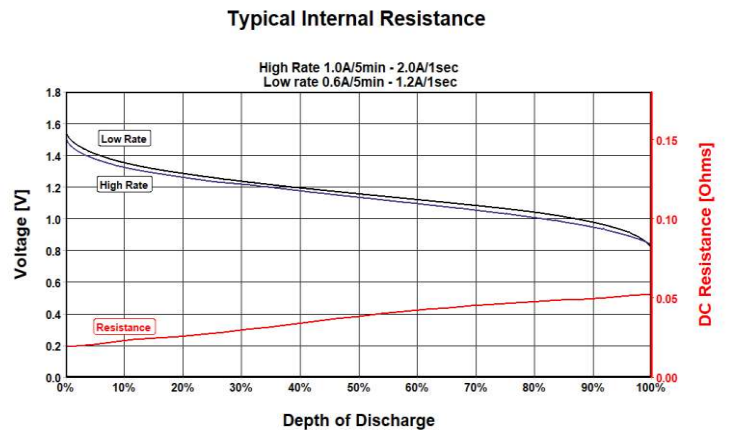
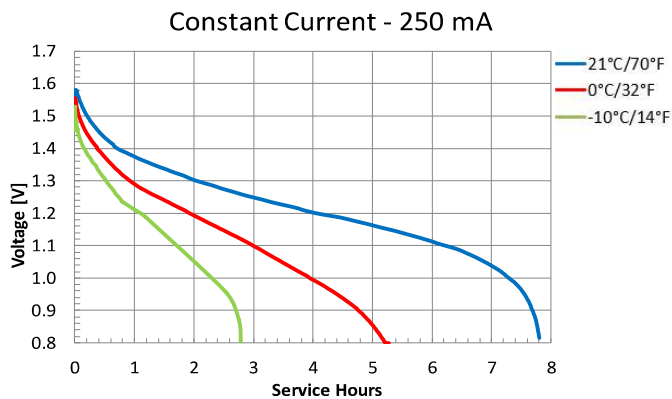
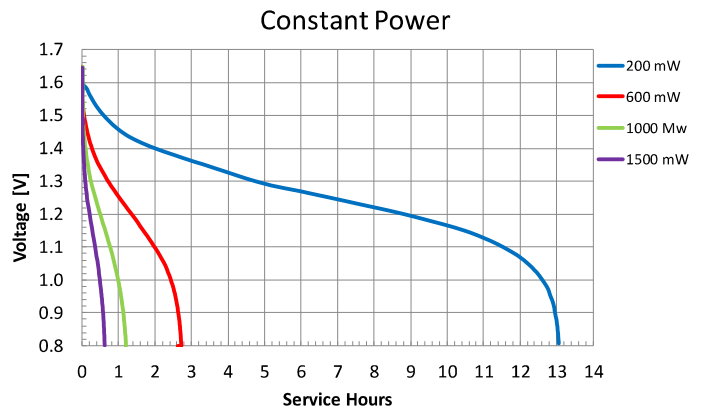
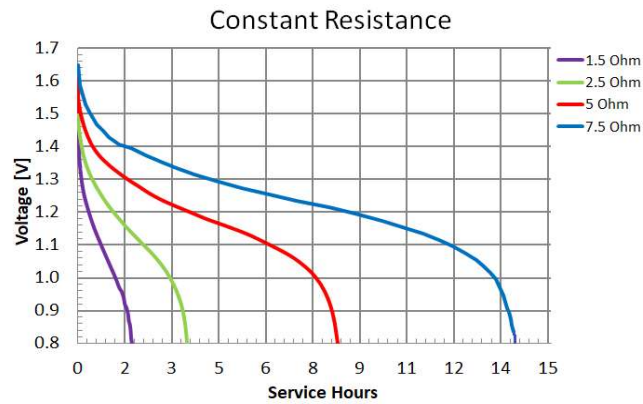
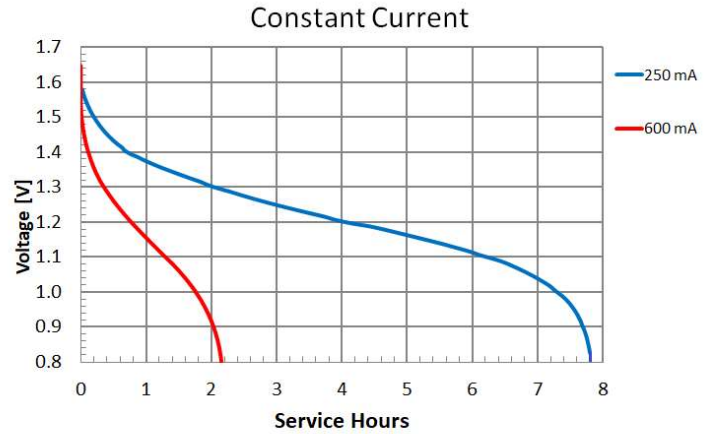
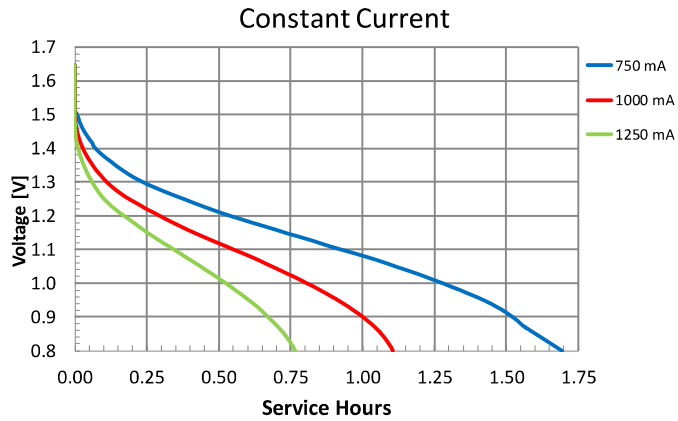

Delivered capacity is dependent on the applied load, operating temperature and cut-off voltage. Please refer to the charts and discharge data shown for examples of the energy/service life that the battery will provide for various load conditions.

This data is subject to change. Performance information is typical. Contact Duracell for the latest information.