

## 1200W / 1500W Modular power supply



Features	Benefits
• BF ready medical isolation (MOPP)	Eases design into systems (including BF)
• Low speed, low audible noise fans	Enhanced patient / user experience
• Up to 16 outputs	Eliminates need for additional supplies
• PMBus™ communication option	Remote monitoring and control
• 7 year warranty	Low cost of ownership

Input		
Output power	1200W	1500W
Input voltage	90-264Vac	150-264Vac
Frequency	47 - 63 Hz (440Hz with reduced PFC)	
Input fuses	25A / 250Vac HBC Fast acting (not user accessible) in both Live and Neutral lines (single fusing optional)	
Inrush current	<45A at 25°C and 264Vac (cold start)	
Leakage current	See 'How To Create A Product Description' for details	
Touch current	<100µA (with 4 or fewer modules). For other configurations, contact sales for details.	
Power factor	> 0.95 (at 230Vac, 100% load)	

Isolation		
Input to output / signals	Reinforced	2 x MOPPs (3rd edition 60601) 4kVac, 5.7kVdc type tested to 4kVac (equivalent to 5.7kVdc), production tested to 4.3kVdc.
Input to earth	Basic	1 x MOPP, 1.5kVac
Output / signals to earth	Basic	1 x MOPP, 1.5kVac
Output / signals to output / signals	Basic	200Vdc

### How To Create A Product Description

The extensive range of output modules and options make it possible to achieve almost any combination of Volts and Amps. You can create your own QM configuration online at <https://config.emea.tdk-lambda.com/>. This method checks your configuration and offers the optimum solution. Alternatively, you can do this manually by using the guide below.

- Calculate total output power to select the appropriate converter, then select required Cooling, Connection, Leakage Current and Controls/ Signals from the following table:

**Converter** **QM7** 7 slots wide (follow by 'H' for extended holdup, contact sales for details)

**Cooling** **F** Variable speed Forward air - standard  
**R** Reverse air (contact sales for details)  
**C** Customer air - no fan (contact sales for details)

**Input Connection** **S** Screw

**Input fuse** **D** Dual AC fuses  
**E** Single AC fuse in Live line (contact sales for details)

**Leakage Current** (max at 264Vac, 63Hz)  
 Must also add the leakage current from modules and options  
**L** 214µA  
**R** 77µA

**Standby / Signals**  
**blank** none  
**E5L** 5V / 250mA, Enable  
**E5H** 5V / 2A, 5V / 250mA, Enable  
**E12H** 12V / 1A, 5V / 250mA, Enable  
**T5L** 5V / 250mA, Inhibit  
**T5H** 5V / 2A, 5V / 250mA, Inhibit  
**T12H** 12V / 1A, 5V / 250mA, Inhibit  
**P5H** 5V / 2A, see PMBus™ app note  
 see specification page for details

**QM7** **F** **S** **D** **L** **T5H**

- Select Output Modules using the output voltages tables and the module specifications.
- Contact TDK-Lambda to validate configuration and issue a part number.

**Possible Outputs** - see individual module data for full specifications

Module name	Slots used	Output voltage range		Maximum Output Current	Maximum Output Power
DM (ch2)	1 of 2 outputs in single slot	2.8V	- 3.8V	10A	33W
SB	1 slot	3.3V	- 3.63V	37A	122W
DM (ch2)	1 of 2 outputs in single slot	4.25V	- 5.75V	10A	50W
SA	1	5V	- 5V	15A	75W
SB	1	5V	- 5.5V	30A	150W
SC	2	5V	- 5.5V	60A	300W
ZD	3	5V	- 5.3V	80A	400W
ZF	4	5V	- 5.3V	110A	550W
YC	2	6.6V	- 7.26V	37A	244W
YC	2	10V	- 11V	30A	300W
YF	4	10V	- 11V	60A	600W
DH (ch1 or ch2)	1 of 2 outputs in single slot	10.2V	- 13.8V	10A	120W
DM (ch1)	1 of 2 outputs in single slot	11.9V	- 16.1V	10A	120W
DM (ch2)	1 of 2 outputs in single slot	11.9V	- 16.1V	8.3A	100W
SA	1	12V	- 12V	12.5A	150W
SB	1	12V	- 13.2V	25A	300W
SC	2	12V	- 13.2V	50A	600W
ZD	3	12V	- 12.8V	65A	780W
ZF	4	12V	- 12.8V	90A	1080W
DH (ch1 or ch2)	1 of 2 outputs in single slot	12.75V	- 17.25V	8A	120W
SA	1	15V	- 15V	10A	150W
SB	1	15V	- 16.5V	20A	300W
ZC	2	15V	- 16V	36A	540W
SB	1	18V	- 19.8V	16.7A	300W
ZC	2	18V	- 19.2V	30A	540W
DH (ch1 or ch2)	1 of 2 outputs in single slot	20.4V	- 27.6V	5A	120W
YB	1	20.4V	- 27.6V	9.8A	200W
DM (ch1)	1 of 2 outputs in single slot	20.8V	- 28.2V	5A	120W
DM (ch2)	1 of 2 outputs in single slot	23.5V	- 24.5V	4.16A	100W
SA	1	24V	- 24V	6.25A	150W
SB	1	24V	- 26.4V	12.5A	300W
SC	2	24V	- 26.4V	25A	600W
ZD	3	24V	- 25.6V	30A	720W
YF	4	24V	- 26.4V	50A	1200W
DH (ch1 or ch2)	1 of 2 outputs in single slot	23.0V	- 31V	4.4A	120W
YB	1	27.6V	- 34.5V	7.25A	200W
SB	1	28V	- 30.8V	10.7A	300W
ZC	2	28V	- 30V	19.3A	540W
YC	2	30V	- 33V	20A	600W
SC	2	36V	- 39.6V	16.7A	600W
ZF	4	36V	- 38.4V	29A	1044W
YB	1	40.8V	- 55.2V	4.9A	200W
SB	1	48V	- 52.8V	6.25A	300W
SC	2	48V	- 52.8V	12.5A	600W
ZD	3	48V	- 51.2V	15A	720W
YF	4	48V	- 52.8V	25A	1200W
YB	1	55.2V	- 62V	3.62A	200W
YC	2	56V	- 61.6V	10.7A	600W
YF	4	72V	- 79.2V	16.7A	1200W
YC	2	96V	- 105.6V	6.25A	600W
YF	4	96V	- 105.6V	12.5A	1200W

Note. 'Maximum Output Current' and 'Maximum Output Power' above are the maximum available from the module. It is not possible to exceed the 'Output Power' of the unit given on the previous page.

Output Specification		
Turn on time	2s max	at 90Vac (150Vac for 1500W) and 100% rated output power
Efficiency	up to 91%	240Vac & above 50% rated power, configuration dependent
Hold up	20ms min 16ms min	at 1200W output power. 1 cycle ride-through option available, contact sales for details. at 1500W output power
Over temperature protection	Yes	converter protection shuts down all outputs (except standby supplies) and fan, auto restarts. Shutdown temperature varies according to ambient, output power and input voltage.

Environment	
Temperature	-20°C to 70°C operational, -40°C to 70°C storage.
Derating	50°C to 70°C derate total output power and each output current by 2.5% per °C Additionally, the 0.25A standby supply provided with the E5H, E12H, T5H and T12H options derates by 2.4% per °C from 25°C to 50°C when the unit is inhibited (fan not running)
Low temperature startup	-40°C
Humidity	5 - 95% RH non condensing
Shock	±3 x 30g shocks in each plane, total 18 shocks (11ms (+/-0.5msec), half sine) Conforms to EN60068-2-27, EN60068-2-47, IEC68-2-27, IEC68-2-47, JIS C0041-1987. Conforms to MIL-STD-810G, Method 516.6, Pro IV
Vibration	Single axis 10 - 500 Hz at 2g (sweep and endurance at resonance) in all 3 planes Conforms to EN60068-2-6, IEC68-2-6 Conforms to MIL-STD-810G, Method 514.6, Pro I
Altitude	5000 metres operational, 5000 metres storage/transportation
Pollution	Degree 2, Material group IIIb
IP Rating	IPX0

Emissions EN61000-6-3:2007, EN60601-1-2:2015 - see application notes for best installation practice		
Radiated electric field	EN55011, EN55032	(as per CISPR.11/32) Class B, FCC47 part 15 subpart B - 'L' leakage current variants (Units with 'R' type leakage current option achieve Class A)
Conducted emissions	EN55011, EN55032	(as per CISPR.11/32) Class B, FCC47 part 15 subpart B - 'L' leakage current variants (Units with 'R' type leakage current option achieve Class A)
Conducted harmonics	EN61000-3-2	Class A and Class C
Flicker	EN61000-3-3	Compliant - d <sub>max</sub> only

Immunity EN61000-6-2:2005, EN60601-1-2:2015 - see application notes for best installation practice				Criteria
Electrostatic discharge	EN61000-4-2	Level 4	F type cooling only	A
Electromagnetic field	EN61000-4-3	Level 3	Proximity fields, EN60601-1-2, Levels as defined in standard, Criteria A	A
Fast / burst transient	EN61000-4-4	Level 4	Tested at 5kHz and 100kHz	A
Surge immunity	EN61000-4-5	Level 3		A
Conducted RF immunity	EN61000-4-6	Level 3		A
Power frequency magnetic field	EN61000-4-8	Level 4		A
Voltage dips, variations, interruptions	EN61000-4-11	Class 3	Criteria B for 5s and 1 cycle interruptions	A
Voltage sags	Semi F-47	compliant	above 180Vac input	
Ring wave	EN61000-4-12	Level 3		A
	ANSI C62.41	3kV	30Ω Neutral Grounding (0.5µs-100kHz Ring Wave)	A
Voltage fluctuations	EN61000-4-14	Class 3	See EMC report for full details.	A

Approvals / Accreditations	
IEC/EN 62368-1, UL62368-1 / CSA 22.2 No 62368-1	File E135494
IEC/EN 60950-1, UL60950-1 / CSA 22.2 No 60950-1	File E135494
IEC/EN 60601-1, UL/CSA 60601-1, ANSI/AAMI ES60601-1, CAN/CSA-C22.2 No 60601-1	File E349607
IEC/EN 61010-1	Designed to meet
CE Mark (EN62368-1)	Low Voltage Directive (LVD), electromagnetic compatibility (EMC) and Restriction of Hazardous Substances (RoHS)
CB certificate and Report available on request	
Designed and manufactured under the control of ISO9001 and ISO13485 (including risk management).	

## Standby / Signals

Maximum power per channel	See table below
Available signals (Exx or Txx type)	PSU inhibit (Txx type) or enable (Exx type), AC Good
Available signals (Pxx type)	PMBus™ control of power supply fan speed and fail warning Serial number, date of manufacture, run time, on/off power cycles For further details, see the product range application notes, PMBus™ section
Additional Leakage Current (max at 264Vac, 63Hz)	xxL = 13.1µA, xxH = 15µA Must also add the leakage current from modules and selected filter option.

### Available Output Voltages (at PSU signal connector)

Option type	Standby 1			Standby 2			PSU on/off
	V	Max Current	Power	V	Max Current	Power	
E5L	5V	250mA	1.25W	not available			Enable
E5H	5V	250mA	1.25W	5V	2A	10W	Enable
E12H	5V	250mA	1.25W	12V	1A	12W	Enable
T5L	5V	250mA	1.25W	not available			Inhibit
T5H	5V	250mA	1.25W	5V	2A	10W	Inhibit
T12H	5V	250mA	1.25W	12V	1A	12W	Inhibit
P5H	5V	2A	10W	not available			see PMBus™ application note
P12H	12V	1A	12W	not available			see PMBus™ application note

Txx or Exx option		
Pin	5L	5H or 12H
1	Do not connect	Standby 2 +
2	Do not connect	Standby 2 -
3	Standby 1 +	Standby 1 +
4	Standby 1 -	Standby 1 -
5	PSU on/off+	PSU on/off+
6	PSU on/off-	PSU on/off-
7	AC fail Out	AC fail Out
8	AC fail Rtn	AC fail Rtn
9	Do not connect	
10	Do not connect	

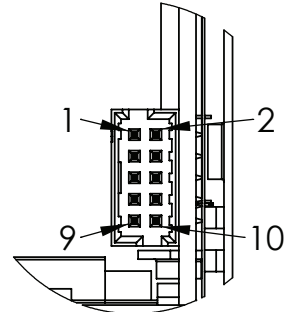

P5H or P12H option	
Pin	Option
1	Standby +
2	Standby -
3	Do not connect
4	Fan fail
5	Address 0
6	Address 1
7	Address 2
8	Address 3
9	SCL - Clock
10	SDA - Data
11	Control line in
12	GND

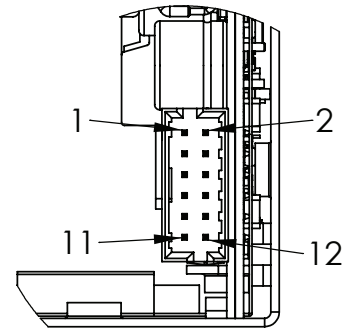

## Output Specification

	Standby 1	Standby 2
Rise time	<30ms	(with resistive load) to 90% of voltage, monotonic rise above 10%
Ripple and noise	<1%	pk-pk, using 20MHz bandwidth
Voltage setting accuracy	<3%	of set voltage
Remote sense	No	
Minimum load	0W	on any output
Temperature coefficient	0.02%	of rated voltage per °C
Load regulation	<1.5%	<1% for 0-100% load change
Line regulation	<0.1%	for 90-264Vac input change
Cross regulation	<0.4%	for 100% load change on any output
Transient deviation	<5%	of set voltage for 25-50% load change
Recovery	1ms	for recovery to 1% or 100mV of set voltage
Over voltage protection	Yes	Latching, output shuts down, cycle ac to reset
Over current protection	Constant Current	Auto recovers
Short circuit protection	Constant Current	Auto recovers

## DH Module - single slot width, 2 output channels

Maximum module power	200W	Total power from channel 1 + channel 2
Maximum power per channel	see table below	
Available signals	Module good, module inhibit	
Additional Leakage Current (max at 264Vac, 63Hz)	20.5µA	Must also add the leakage current from other modules, any standby supply and selected filter option.

### AVAILABLE OUTPUT VOLTAGES (at PSU output terminals)

Channel 1				Channel 2			
Adjustment Range (Volts)	Current	Output power	Max C load	Adjustment Range (Volts)	Current	Output power	Max C load
10.2 <sub>a</sub> - 13.8	10A	120W	1000µF/A	10.2 - 13.8	10A	120W	1000µF/A
				12.75 - 17.25	8A	120W	1000µF/A
				20.4 - 27.6	5A	120W	750µF/A
12.75 <sub>b</sub> - 17.25	8A	120W	1000µF/A	12.75 - 17.25	8A	120W	1000µF/A
				20.4 - 27.6	5A	120W	750µF/A
20.4 <sub>c</sub> - 27.6	5A	120W	750µF/A	20.4 - 27.6	5A	120W	750µF/A
23.0 <sub>d</sub> - 31	4.4A	120W	750µF/A	23.0 - 31	4.4A	120W	750µF/A

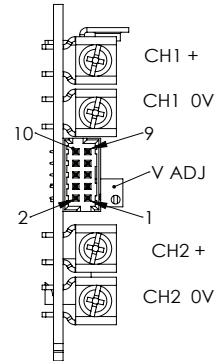

Pin	Connection
1	Do not connect
2	Do not connect
3	Module good collector
4	Module good emitter
5	Module inhibit anode
6	Module inhibit cathode
7	
8	Do not connect
9	Do not connect
10	Do not connect

Channel 1 and channel 2 of DH are both adjusted by single potentiometer. The V2 set =  $V2_{max} \times V1_{set} / V1_{max}$   
a, b, c, d - for output voltages below 10.8V(a), 13.5V(b), 21.6V(c) or 24.4V(d), a Minimum load of 1W must be applied to channel 1

### Output Specification

Rise time	<50ms	(with resistive load) to 90% of voltage, monotonic rise above 10%
Turn on overshoot	zero	at full load with resistive load.
Ripple and noise		pk-pk, using 20MHz bandwidth
0°C - 70°C	1.5%	
-20°C - 0°C	2.25%	
Voltage setting accuracy	<1%	of set voltage (3% for channel 2)
Remote sense	No	
Minimum load	0W	Except for notes a, b, c and d above.
Temperature coefficient	0.03%	of rated voltage per °C
Load regulation	<6%	for 5-100% load change
Line regulation	<0.1%	for 90-264Vac input change
Cross regulation	3%	for 5-100% load change on any output
Transient deviation	<4%	of set voltage for 50% load change (above 25% load)
Recovery	3ms	for recovery to 1% or 100mV of set voltage
Over voltage protection	Yes	Latching, module shuts down (both outputs), cycle ac to restart.
Module current protection	Hiccup	Protects channel 1 and channel 2, shuts down both outputs, auto-recovers when fault clears.
Short circuit protection	Yes	Indefinitely protected, see application notes for details
Over temperature protection	Yes	Module protection shuts down both outputs, cycle ac to restart. Shutdown temperature varies according to ambient, output power and input voltage.

### How To Create A Product Description

Choose your required channel 1 and channel 2 voltages (from the table above)  
For example, if you need 12V / 10A and 24V / 3A, you would choose **12/24DHS** as your required module.

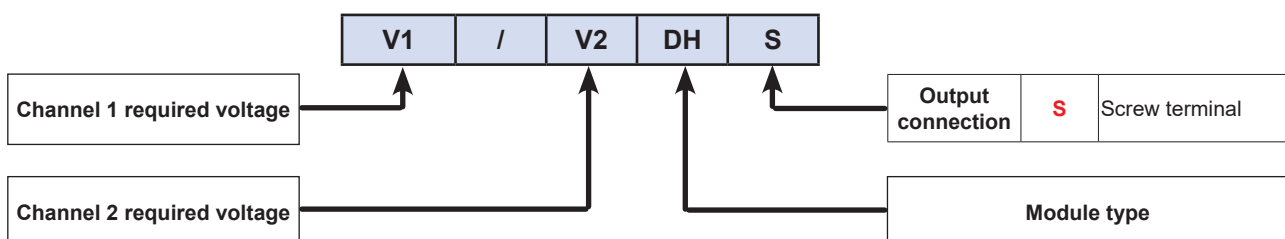

## DM Module - single slot width, 1 or 2 output channels

Maximum module power	200W	Total power from channel 1 + channel 2
Maximum power per channel	see table below	
Available signals	Remote sense (channels 1 & 2), channel 1 good, channel 2 good, Channel 2 inhibit, module inhibit	
Additional Leakage Current (max at 264Vac, 63Hz)	22.3µA	Must also add the leakage current from other modules, and standby supply and selected filter option.

### AVAILABLE OUTPUT VOLTAGES (at PSU output terminals)

Channel 1				Channel 2			
Adjustment Range (Volts)	Current	Output power	Max C load	Adjustment Range (Volts)	Current	Output power	Max C load
Channel 1 unused				2.8 - 3.8	10A	33W	500µF/A
				4.25 - 5.75	10A	50W	500µF/A
11.9 - 16.1	10A	120W	500µF/A	Channel 2 unused			
20.8 - 28.2	5A	120W	500µF/A				
				2.8 - 3.8	10A	33W	500µF/A
				4.25 - 5.75	10A	50W	500µF/A
				11.9 - 16.1	8.3A	100W	500µF/A
				23.5 - 24.5	4.16A	100W	500µF/A
				2.8 - 3.8	10A	33W	500µF/A
				4.25 - 5.75	10A	50W	500µF/A
				23.5 - 24.5	4.16A	100W	500µF/A

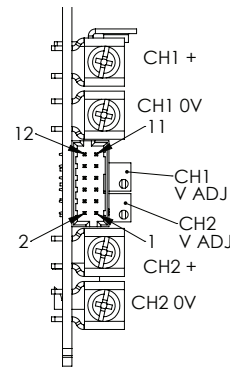

Pin	Connection
1	Ch2 sense +
2	Ch2 sense -
3	Ch2 inhibit anode
4	Ch2 inhibit cathode
5	Ch2 good collector
6	Ch2 good emitter
7	Ch1 good collector
8	Ch1 good emitter
9	Module inhibit anode
10	Module inhibit cathode
11	Ch1 sense +
12	Ch1 sense -

Output Specification	Ch1	Ch2	
Rise time	<20ms	<50ms	(with resistive load) to 90% of voltage, monotonic rise above 10%
Turn on overshoot	<5%	<5%	Load type dependent, no overshoot at full load with resistive load
Ripple and noise			pk-pk, using 20MHz bandwidth
0°C - 70°C	1.5%	75mV	1.5% for ch2 outputs >10V, 2% for outputs 11-17V
-20°C - 0°C	2.25%	75mV	2% for ch2 outputs >10V, 2.5% for outputs 11-17V
Voltage setting accuracy	<1%	<1%	of set voltage
Remote sense	Yes		0.5V (voltage at the output terminals must be within the specified adjustment range)
Minimum load		0W	Refer to application note for details.
Temperature coefficient	0.02%		of rated voltage per °C
Load regulation	max of 50mV or <1% of set voltage		for 0-100% load change
Line regulation	<0.1%		for 90-264Vac input change
Cross regulation	1.5%		for 100% load change on any output
Transient deviation	<4%	<5%	of set voltage for 50% load change (above 25% load). 250mV for outputs below 5V
Recovery	3ms	7ms	for recovery to 1% or 100mV of set voltage
Over voltage protection	Yes		Latching, module shuts down (both outputs), cycle ac to restart.
Over current protection	Hiccup	Constant current	Ch1 protection shuts down both outputs.
Short circuit protection	Hiccup	Constant current	Ch1 protection shuts down both outputs. Refer to application note for details.
Over temperature protection	Yes	Yes	Ch1 protection shuts down both outputs, cycle ac to restart. Ch2 protection shuts down ch2 only, auto recovers when fault clears. Shutdown temperature varies according to ambient, output power and input voltage.

## How To Create A Product Description

Choose your required channel 1 and channel 2 voltages (from the table above)

For example, if you need 12V / 10A and 3.3V / 10A, you would choose **12/3.3DM5** as your required module.

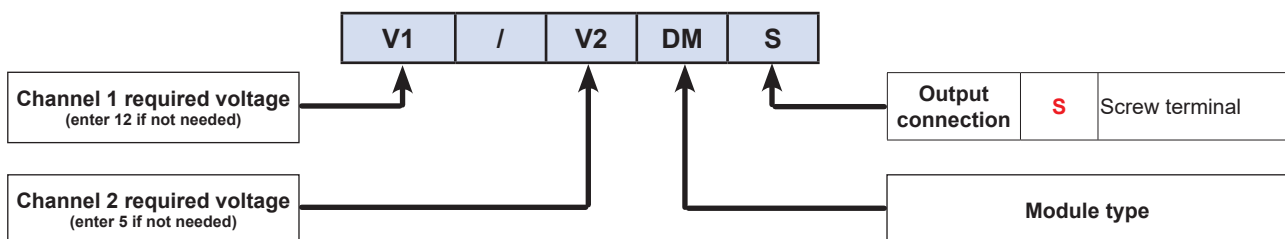

## SA Module - single slot width, 1 output channel

Maximum power per channel	see table below
Available signals	Remote sense (5V module only)
Additional Leakage Current (max at 264Vac, 63Hz)	14.6µA Must also add the leakage current from other modules, any standby supply and selected filter option.

### AVAILABLE OUTPUT VOLTAGES (at PSU output terminals)

Output voltage	Current	Output power	Maximum capacitive load
5V	15A	75W	1000µF/A
12V	12.5A	150W	1000µF/A
15V	10A	150W	1000µF/A
24V	6.25A	150W	750µF/A

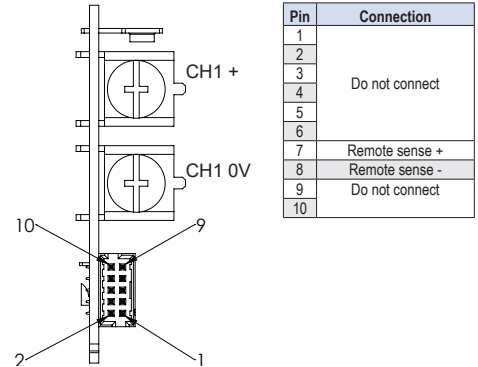

## Output Specification

Rise time	<75ms	(with resistive load) to 90% of voltage, monotonic rise above 10%
Turn on overshoot	<5% or 250mV	Load type dependent, no overshoot at full load with resistive load 6% for 12V output
Ripple and noise		pk-pk, using 20MHz bandwidth
0°C - 70°C, >5% load	1%	
-20°C - 0°C, >5% load	2%	
≤5% load	2%	
Voltage setting accuracy	<1%	of set voltage
Remote sense	Yes	On 5V module only
Minimum load	No	on any output
Temperature coefficient	<0.02%	of rated voltage per °C
Load regulation	<1%	for 0-100% load change
Line regulation	<0.2%	for 90-264Vac input change
Cross regulation	<0.2%	for 100% load change on any output
Transient deviation	<5% or 250mV	of set voltage for 50% load change (above 25% load)
Recovery	5ms	for recovery to 1% or 100mV of set voltage
Over voltage protection	Yes	Latching, module shuts down, cycle ac to restart
Over current protection	Hiccup	Auto recovers after removal of load
Short circuit protection	Yes	Indefinitely protected, see application notes for details
Over temperature protection	Yes	Module protection shuts down output, cycle ac to restart. Shutdown temperature varies according to ambient, output power and input voltage.

## How To Create A Product Description

Choose your required output voltage (from the table above)  
For example, if you need 15V / 10A, you would choose **15SASL** as your required module.

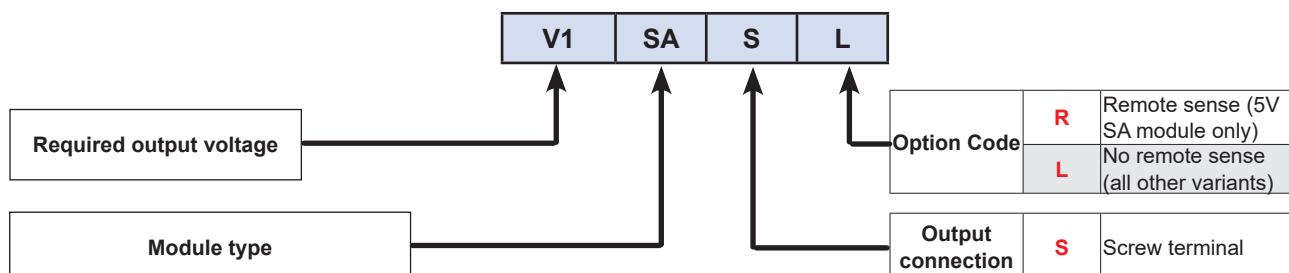

## SB Module - single slot width, 1 output channel

Maximum power per channel	see table below
Available signals	Remote sense, module good, module inhibit
Additional Leakage Current (max at 264Vac, 63Hz)	14.6µA Must also add the leakage current from other modules, any standby supply and selected filter option.

### AVAILABLE OUTPUT VOLTAGES (at PSU output terminals)

Adjustment Range (Volts)		Current	Output power	Max Capacitive Load
3.3	- 3.63	37A	122W	1000µF/A
5	- 5.5	30A	150W	1000µF/A
12	- 13.2	25A	300W	1000µF/A
15	- 16.5	20A	300W	1000µF/A
18	- 19.8	16.7A	300W	1000µF/A
24	- 26.4	12.5A	300W	750µF/A
28	- 30.8	10.7A	300W	500µF/A
48	- 52.8	6.25A	300W	250µF/A

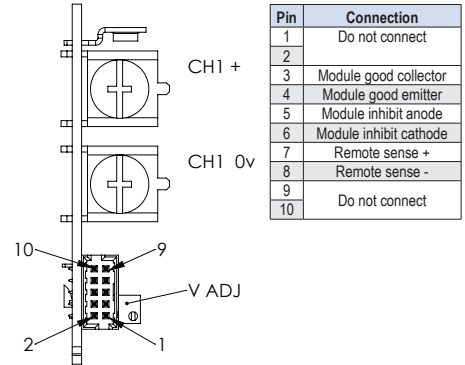

## Output Specification

Rise time	<75ms	(with resistive load) to 90% of voltage, monotonic rise above 10%
Turn on overshoot	<5%	Load type dependent
Ripple and noise	max of	pk-pk, using 20MHz bandwidth
0°C - 70°C, >5% load	1% or 50mV	
-20°C - 0°C, >5% load	2% or 100mV	
≤5% load	4%	
Voltage setting accuracy	<1%	of set voltage
Remote sense	Yes	0.5V (voltage at the output terminals must remain within the adjustment range specified above)
Minimum load	0W	
Temperature coefficient	0.016%	of rated voltage per °C
Load regulation	<1%	for 0-100% load change
Line regulation	<0.1%	for 90-264Vac input change
Cross regulation	0.1%	(5mV for outputs below 5V) for 100% load change on any output
Transient deviation	<5%	of set voltage for 50% load change (above 25% load) 250mV for outputs below 5V
Recovery	1ms	for recovery to 1% or 100mV of set voltage
Over voltage protection	Yes	Latching, module shuts down, cycle ac to restart.
Over current protection	Hiccup	Auto recovers after removal of load
Short circuit protection	Yes	Indefinitely protected, see application notes for details
Over temperature protection	Yes	Module protection shuts down output, cycle ac to restart. Shutdown temperature varies according to ambient, output power and input voltage.

## How To Create A Product Description

Choose your required output voltage (from the table above)  
For example, if you need 12.2V / 24.5A, you would choose **12.2SBS** as your required module.

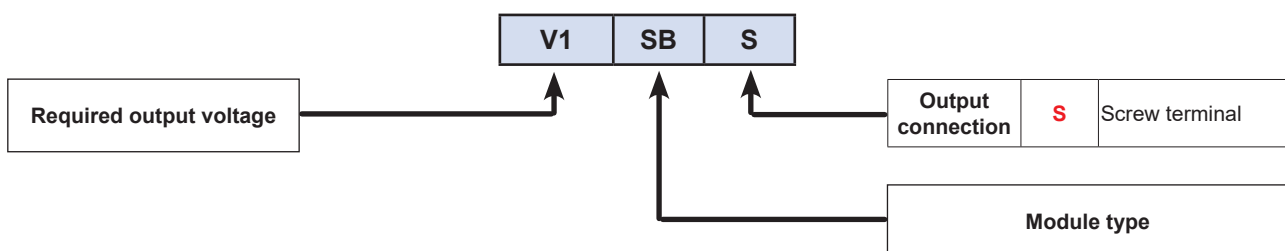



## SC Module - two slots width, 1 output channel

Maximum power per channel	see table below
Available signals	Remote sense, module good, module inhibit
Additional Leakage Current (max at 264Vac, 63Hz)	13.8µA Must also add the leakage current from other modules, any standby supply and selected filter option.

### AVAILABLE OUTPUT VOLTAGES (at PSU output terminals)

Adjustment Range (Volts)		Current	Output power	Maximum capacitive load
5	- 5.5	60A	300W	1000µF/A
12	- 13.2	50A	600W	1000µF/A
24	- 26.4	25A	600W	750µF/A
36	- 39.6	16.7A	600W	300µF/A
48	- 52.8	12.5A	600W	250µF/A

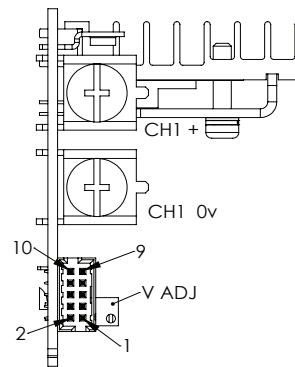

Pin	Connection
1	Do not connect
2	
3	Module good collector
4	Module good emitter
5	Module inhibit anode
6	Module inhibit cathode
7	Remote sense +
8	Remote sense -
9	Do not connect
10	

### Output Specification

Rise time	<75ms	(with resistive load) to 90% of voltage, monotonic rise above 10%
Turn on overshoot	<5%	Load type dependent
Ripple and noise	$V_{out} < 10V$	$V_{out} > 10V$ pk-pk, using 20MHz bandwidth
0°C - 70°C, >5% load	1.5%	1%
-20°C - 0°C, >5% load	3%	2%
≤5% load	4%	4%
Voltage setting accuracy	<1%	of set voltage
Remote sense	Yes	0.5V (voltage at the output terminals must remain within the adjustment range specified above)
Minimum load	0W	
Temperature coefficient	0.016%	of rated voltage per °C
Load regulation	<1%	for 0-100% load change
Line regulation	<0.1%	for 90-264Vac input change
Cross regulation	0.1%	for 100% load change on any output
Transient deviation	<5%	of set voltage for 50% load change (above 25% load)
Recovery	1ms	for recovery to 1% or 100mV of set voltage
Over voltage protection	Yes	Latching, module shuts down, cycle ac to restart.
Over current protection	Hiccup	Auto recovers after removal of load
Short circuit protection	Yes	Indefinitely protected, see application notes for details
Over temperature protection	Yes	Module protection shuts down output, cycle ac to restart. Shutdown temperature varies according to ambient, output power and input voltage.

### How To Create A Product Description

Choose your required output voltage (from the table above)  
For example, if you need 12.2V / 49A, you would choose **12.2SCS** as your required module.

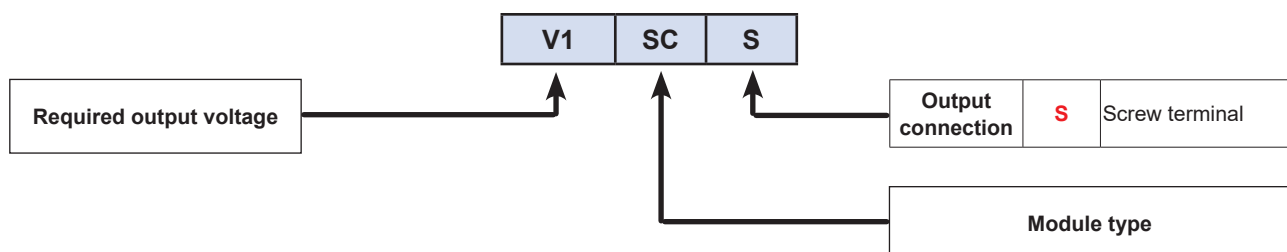

## YB Module - single slot width, 1 output channel

Maximum power per channel	see table below
Available signals	Module good, module inhibit
Additional Leakage Current (max at 264Vac, 63Hz)	20.5µA Must also add the leakage current from other modules, any standby supply and selected filter option.

### AVAILABLE OUTPUT VOLTAGES (at PSU output terminals)

Adjustment Range (Volts)		Current	Output power	Maximum capacitive load
20.4	- 27.6	9.8A	200W	500µF/A
27.6	- 34.5	7.25A	200W	500µF/A
40.8	- 55.2	4.9A	200W	375µF/A
55.2	- 62	3.62A	200W	375µF/A

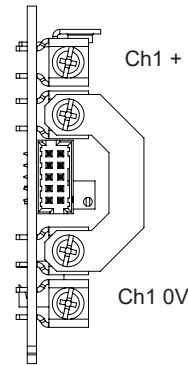

Pin	Connection
1	Do not connect
2	Do not connect
3	Module good collector
4	Module good emitter
5	Module inhibit anode
6	Module inhibit cathode
7	Do not connect
8	
9	
10	

## Output Specification

Rise time	<75ms	(with resistive load) to 90% of voltage, monotonic rise above 10%
Turn on overshoot	zero	at full load with resistive load. Load type dependent, <7% overshoot with capacitive load
Ripple and noise		pk-pk, using 20MHz bandwidth
0°C - 70°C	1.5%	
-20°C - 0°C	2.25%	
Voltage setting accuracy	<2%	of set voltage
Remote sense	No	
Minimum load	0W	
Temperature coefficient	0.03%	of rated voltage per °C
Load regulation	<6%	for 5-100% load change
Line regulation	<0.1%	for 90-264Vac input change
Cross regulation	<1%	for 100% load change on any output
Transient deviation	<8%	of set voltage for 50% load change (above 25% load)
Recovery	5ms	for recovery to 1% or 100mV of set voltage
Over voltage protection	Yes	Latching, module shuts down, cycle ac to restart.
Over current protection	Hiccup	Auto recovers
Short circuit protection	Yes	Indefinitely protected, see application notes for details
Over temperature protection	Yes	Module protection shuts down output, cycle ac to restart. Shutdown temperature varies according to ambient, output power and input voltage.

## How To Create A Product Description

Choose your required output voltage (from the table above)  
For example, if you need 41V / 4A, you would choose **41YBS** as your required module.

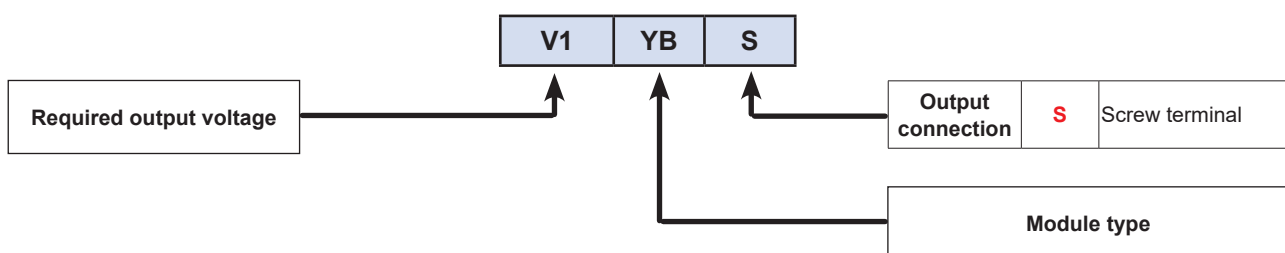

## YC Module - two slots width, 1 output channel

Maximum power per channel	see table below
Available signals	Module good, module inhibit
Additional Leakage Current (max at 264Vac, 63Hz)	29.2µA Must also add the leakage current from other modules, any standby supply and selected filter option.

### AVAILABLE OUTPUT VOLTAGES (at PSU output terminals)

Adjustment Range (Volts)	Current	Output Power	Max Capacitive Load
6.6 - 7.26	37A	244W	1000µF/A
10 - 11	30A	300W	1000µF/A
30 - 33	20A	600W	1000µF/A
56 - 61.6	10.7A	600W	350µF/A
96 - 105.6V	6.25A	600W	125µF/A

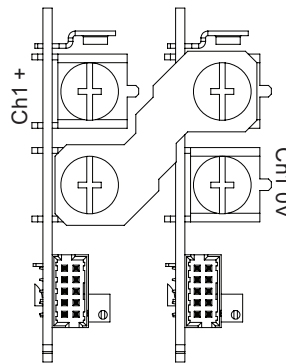

See application notes for signal connection details

### Output Specification

Rise time	<75ms	(with resistive load) to 90% of voltage, monotonic rise above 10%
Turn on overshoot	<5%	Load type dependent
Ripple and noise		pk-pk, using 20MHz bandwidth
0°C - 70°C, >5% load	1%	
-20°C - 0°C, >5% load	2%	
≤5% load	4%	
Voltage setting accuracy	<1%	of set voltage
Remote sense	Yes	0.5V (voltage at the output terminals must remain within the adjustment range specified above)
Minimum load	0W	
Temperature coefficient	0.016%	of rated voltage per °C
Load regulation	<1%	for 0-100% load change
Line regulation	<0.1%	for 90-264Vac input change
Cross regulation	0.1%	(10mV for outputs below 10V) for 100% load change on any output
Transient deviation	<5%	of set voltage for 50% load change (above 25% load)
Recovery	1ms	for recovery to 1% or 100mV of set voltage
Over voltage protection	Yes	Latching, module shuts down, cycle ac to restart.
Over current protection	Hiccup	Auto recovers
Short circuit protection	Yes	Indefinitely protected, see application notes for details
Over temperature protection	Yes	Module protection shuts down output, cycle ac to restart. Shutdown temperature varies according to ambient, output power and input voltage.

### How To Create A Product Description

Choose your required output voltage (from the table above)  
For example, if you need 58V / 10A, you would choose **58YCS** as your required module.

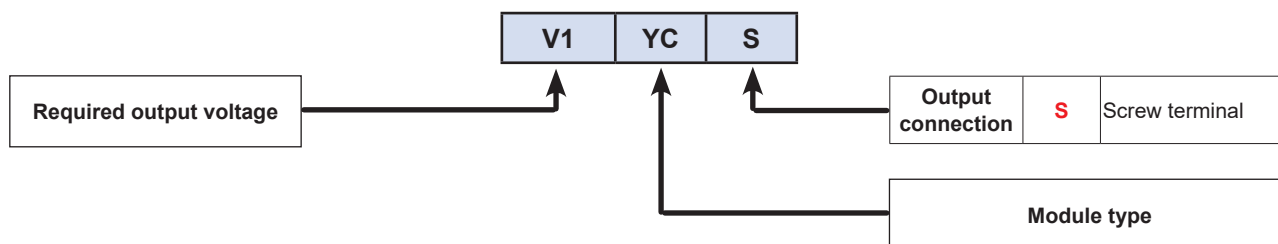

## YF Module - four slots width, 1 output channel

Maximum power per channel	see table below
Available signals	Module good, module inhibit
Additional Leakage Current (max at 264Vac, 63Hz)	27.6µA Must also add the leakage current from other modules, any standby supply and selected filter option.

### AVAILABLE OUTPUT VOLTAGES (at PSU output terminals)

Adjustment Range (Volts)		Current	Output power	Max Capacitive Load
10	- 11	60A	600W	1000µF/A
24	- 26.4	50A	1200W	650µF/A
48	- 52.8	25A	1200W	500µF/A
72	- 79.2	16.7A	1200W	150µF/A
96	- 105.6V	12.5A	1200W	125µF/A

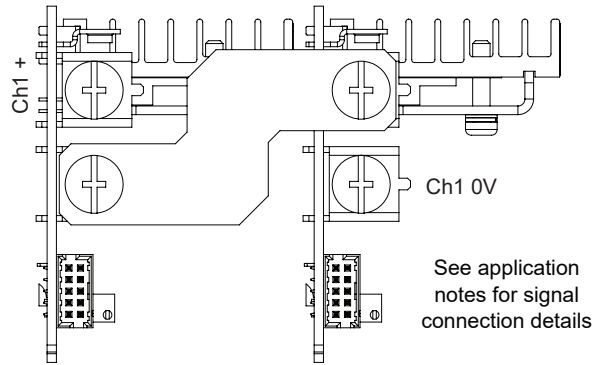

## Output Specification

Rise time	<75ms	(with resistive load) to 90% of voltage, monotonic rise above 10%
Turn on overshoot	<5%	Load type dependent
Ripple and noise	$V_{out} < 20V$	$V_{out} > 20V$ pk-pk, using 20MHz bandwidth
0°C - 70°C, >5% load	1.5%	1%
-20°C - 0°C, >5% load	3%	2%
≤5% load	4%	4%
Voltage setting accuracy	<1%	of set voltage
Remote sense	Yes	0.5V (voltage at the output terminals must remain within the adjustment range specified above)
Minimum load	0W	
Temperature coefficient	0.016%	of rated voltage per °C
Load regulation	<1%	for 0-100% load change
Line regulation	<0.1%	for 90-264Vac input change
Cross regulation	0.1%	for 100% load change on any output
Transient deviation	<5%	of set voltage for 50% load change (above 25% load)
Recovery	1ms	for recovery to 1% or 100mV of set voltage
Over voltage protection	Yes	Latching, module shuts down, cycle ac to restart.
Over current protection	Hiccup	Auto recovers
Short circuit protection	Yes	Indefinitely protected, see application notes for details
Over temperature protection	Yes	Module protection shuts down output, cycle ac to restart. Shutdown temperature varies according to ambient, output power and input voltage.

## How To Create A Product Description

Choose your required output voltage (from the table above)  
For example, if you need 48V / 25A, you would choose **48YFS** as your required module.

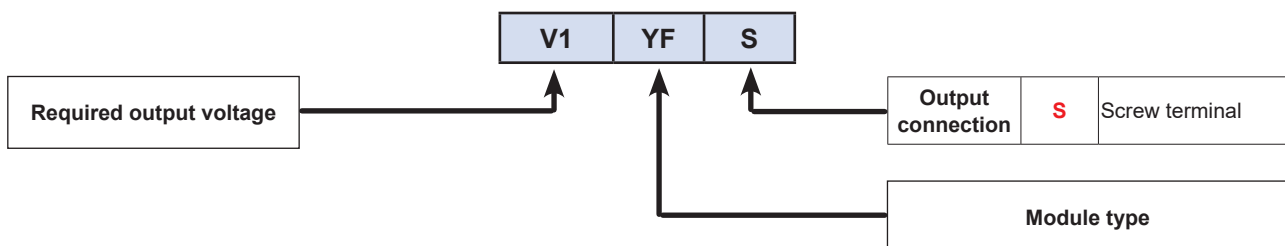

## ZC Module - two slots width, 1 output channel

Maximum power per channel	see table below
Available signals	Module good, module inhibit
Additional Leakage Current (max at 264Vac, 63Hz)	29.2µA Must also add the leakage current from other modules, any standby supply and selected filter option.

### AVAILABLE OUTPUT VOLTAGES (at PSU output terminals)

Adjustment Range (Volts)		Current	Output Power	Maximum capacitive load
15	- 16.0	36A	540W	1000µF/A
18	- 19.2	30A	540W	1000µF/A
28	- 30	19.3A	540W	500µF/A

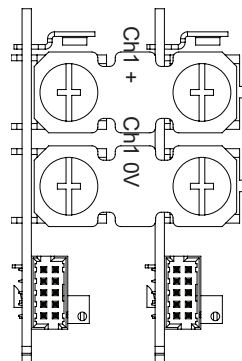

See application notes for signal connection details

### Output Specification

Rise time	<75ms	(with resistive load) to 90% of voltage, monotonic rise above 10%
Turn on overshoot	<5%	Load type dependent
Ripple and noise		pk-pk, using 20MHz bandwidth
0°C - 70°C, >5% load	1%	
-20°C - 0°C, >5% load	2%	
≤5% load	4%	
Voltage setting accuracy	<1%	of set voltage
Remote sense	Yes	0.5V (voltage at the output terminals must remain within the adjustment range specified above)
Minimum load	0W	
Temperature coefficient	0.016%	of rated voltage per °C
Load regulation	<3.5%	for 1-100% load change
Line regulation	<0.1%	for 90-264Vac input change
Cross regulation	0.1%	for 100% load change on any output
Transient deviation	<5%	of set voltage for 50% load change (above 25% load)
Recovery	30ms	for recovery to 1% or 100mV of set voltage
Over voltage protection	Yes	Latching, module shuts down, cycle ac to restart.
Over current protection	Hiccup	Auto recovers after removal of load
Short circuit protection	Yes	Indefinitely protected, see application notes for details
Over temperature protection	Yes	Module protection shuts down output, cycle ac to restart. Shutdown temperature varies according to ambient, output power and input voltage.

### How To Create A Product Description

Choose your required output voltage (from the table above)  
For example, if you need 15V / 36A, you would choose 15ZCS as your required module.

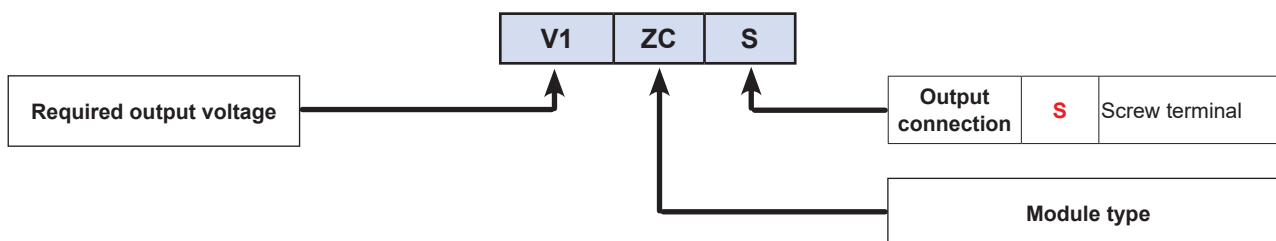

## ZD Module - three slots width, 1 output channel

Maximum power per channel	see table below
Available signals	Module good, module inhibit
Additional Leakage Current (max at 264Vac, 63Hz)	28.3µA Must also add the leakage current from other modules, any standby supply and selected filter option.

### AVAILABLE OUTPUT VOLTAGES (at PSU output terminals)

Adjustment Range (Volts) at PSU output terminal	Current	Output power	Maximum capacitive load
5 - 5.3	80A	400W	1000µF/A
12 - 12.8	65A	780W	1000µF/A
24 - 25.6	30A	720W	750µF/A
48 - 51.2	15A	720W	250µF/A

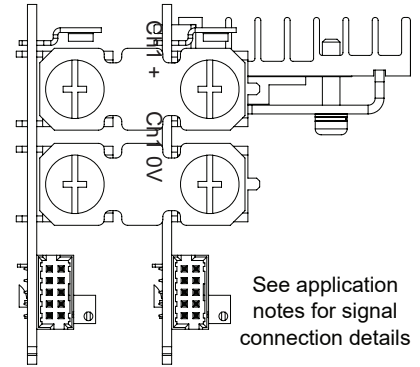

## Output Specification

Rise time	<75ms	(with resistive load) to 90% of voltage, monotonic rise above 10%
Turn on overshoot	<5%	Load type dependent
Ripple and noise	$V_{out} < 10V$	$V_{out} > 10V$ pk-pk, using 20MHz bandwidth
0°C - 70°C, >5% load	1.5%	1%
-20°C - 0°C, >5% load	3%	2%
≤5% load	4%	4%
Voltage setting accuracy	<1%	of set voltage
Remote sense	Yes	0.5V (voltage at the output terminals must remain within the adjustment range specified above)
Minimum load	0W	
Temperature coefficient	0.016%	of rated voltage per °C
Load regulation	<3.5%	for 1-100% load change (<2.5% for 5-5.3V output)
Line regulation	<0.1%	for 90-264Vac input change
Cross regulation	0.1%	for 100% load change on any output
Transient deviation	<5%	of set voltage for 50% load change (above 25% load)
Recovery	30ms	for recovery to 1% or 100mV of set voltage
Over voltage protection	Yes	Latching, module shuts down, cycle ac to restart.
Over current protection	Hiccup	Auto recovers after removal of load
Short circuit protection	Yes	Indefinitely protected, see application notes for details
Over temperature protection	Yes	Module protection shuts down output, cycle ac to restart. Shutdown temperature varies according to ambient, output power and input voltage.

## How To Create A Product Description

Choose your required output voltage (from the table above)  
 For example, if you need 48V / 16A, you would choose **48ZDS** as your required module.

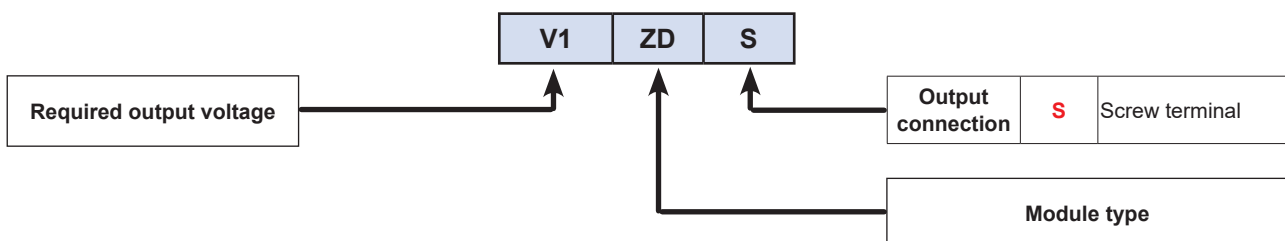

## ZF Module - four slots width, 1 output channel

Maximum power per channel	see table below
Available signals	Module good, module inhibit
Additional Leakage Current (max at 264Vac, 63Hz)	27.6µA Must also add the leakage current from other modules, any standby supply and selected filter option.

### AVAILABLE OUTPUT VOLTAGES (at PSU output terminals)

Adjustment Range (Volts)			Current	Output power	Maximum capacitive load
5	-	5.3	110A	550W	1000µF/A
12	-	12.8	90A	1080W	1000µF/A
36	-	38.4	29A	1044W	300µF/A

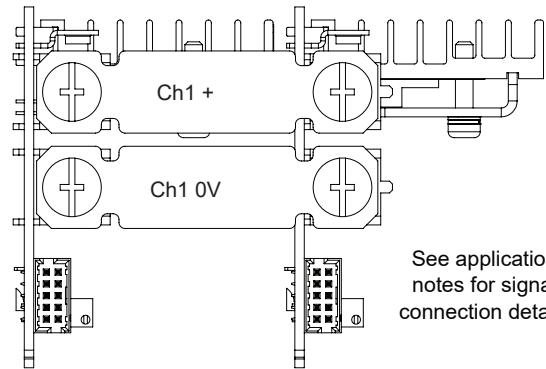

See application notes for signal connection details

## Output Specification

Rise time	<75ms	(with resistive load) to 90% of voltage, monotonic rise above 10%
Turn on overshoot	<5%	Load type dependent
Ripple and noise	$V_{out} < 10V$	$V_{out} > 10V$ pk-pk, using 20MHz bandwidth
0°C - 70°C, >5% load	1.5%	1%
-20°C - 0°C, >5% load	3%	2%
≤5% load	4%	4%
Voltage setting accuracy	<1%	of set voltage
Remote sense	Yes	0.5V (voltage at the output terminals must remain within the adjustment range specified above)
Minimum load	0W	
Temperature coefficient	0.016%	of rated voltage per °C
Load regulation	<3.5%	for 1-100% load change (<2.5% for 5-5.3V output)
Line regulation	<0.1%	for 90-264Vac input change
Cross regulation	0.1%	for 100% load change on any output
Transient deviation	<5%	of set voltage for 50% load change (above 25% load)
Recovery	30ms	for recovery to 1% or 100mV of set voltage
Over voltage protection	Yes	Latching, module shuts down, cycle ac to restart.
Over current protection	Hiccup	Auto recovers after removal of load
Short circuit protection	Yes	Indefinitely protected, see application notes for details
Over temperature protection	Yes	Module protection shuts down output, cycle ac to restart. Shutdown temperature varies according to ambient, output power and input voltage.

## How To Create A Product Description

Choose your required output voltage (from the table above)

For example, if you need 12V / 90A, you would choose **12ZFS** as your required module.

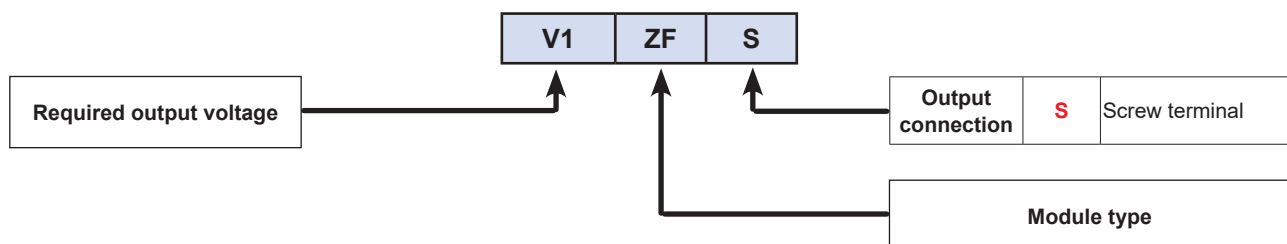

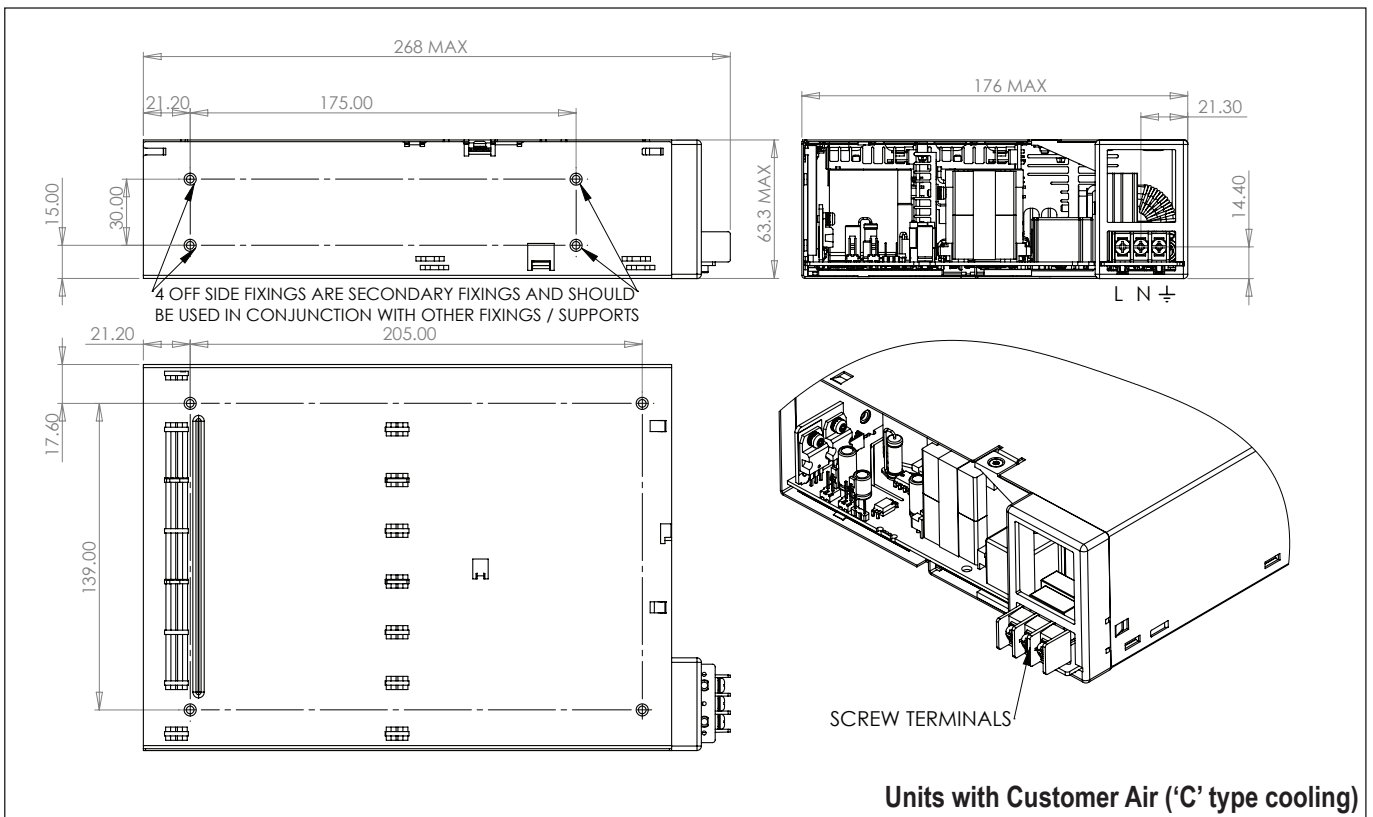
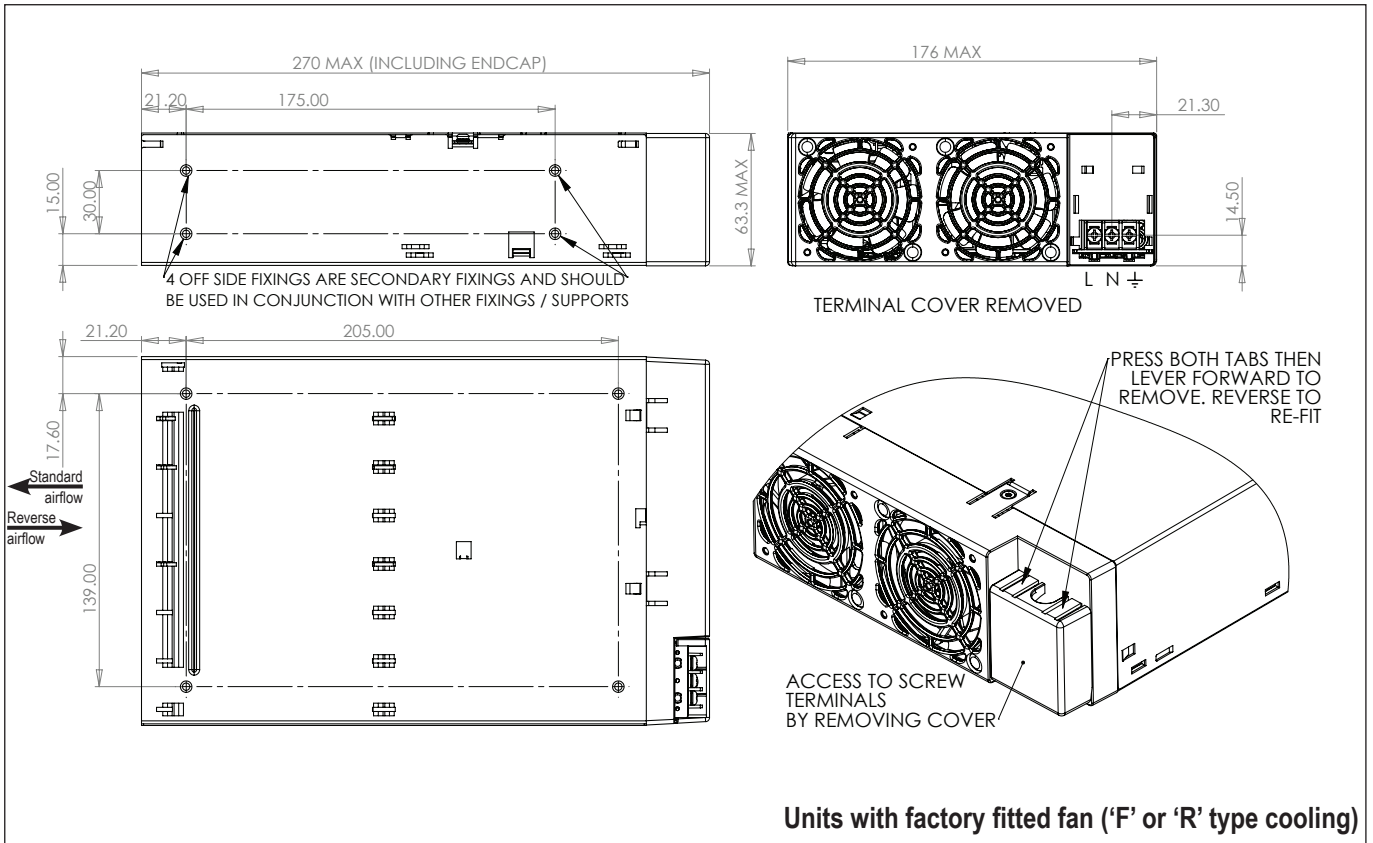

Customer fixings. 8 holes M4. Max thread penetration:- 4.5mm





## TDK-Lambda France SAS

Tel: +33 1 60 12 71 65  
france@fr.tdk-lambda.com  
www.emea.lambda.tdk.com/fr



## Italy Sales Office

Tel: +39 02 61 29 38 63  
info.italia@it.tdk-lambda.com  
www.emea.lambda.tdk.com/it



## Netherlands

info@nl.tdk-lambda.com  
www.emea.lambda.tdk.com/nl



## TDK-Lambda Germany GmbH

Tel: +49 7841 666 0  
info.germany@de.tdk-lambda.com  
www.emea.lambda.tdk.com/de



## Austria Sales Office

Tel: +43 2256 655 84  
info@at.tdk-lambda.com  
www.emea.lambda.tdk.com/at



## Switzerland Sales Office

Tel: +41 44 850 53 53  
info@ch.tdk-lambda.com  
www.emea.lambda.tdk.com/ch



## Nordic Sales Office

Tel: +45 8853 8086  
info@dk.tdk-lambda.com  
www.emea.lambda.tdk.com/dk

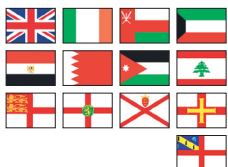

## TDK-Lambda UK Ltd.

Tel: +44 (0) 12 71 85 66 66  
powersolutions@uk.tdk-lambda.com  
www.emea.lambda.tdk.com/uk



## TDK-Lambda Ltd.

Tel: +9 723 902 4333  
info@tdk-lambda.co.il  
www.emea.lambda.tdk.com/il



## C.I.S.

### Commercial Support:

Tel: +7 (495) 665 2627

### Technical Support:

Tel: +7 (812) 658 0463

info@tdk-lambda.ru  
www.emea.lambda.tdk.com/ru



## TDK-Lambda Americas

Tel: +1 800-LAMBDA-4 or 1-800-526-2324  
powersolutions@us.tdk-lambda.com  
www.us.lambda.tdk.com



## TDK Electronics do Brasil Ltda

Tel: +55 11 3289-9599  
sales.br@tdk-electronics.tdk.com  
www.tdk-electronics.tdk.com/en



## TDK-Lambda Corporation

Tel: +81-3-6778-1113  
www.jp.lambda.tdk.com



## TDK-Lambda (China) Electronics Co. Ltd.

Tel: +86 21 6485-0777  
powersolutions@cn.tdk-lambda.com  
www.lambda.tdk.com.cn



## TDK-Lambda Singapore Pte Ltd.

Tel: +65 6251 7211  
tfs.mkt@sg.tdk-lambda.com  
www.sg.lambda.tdk.com



## TDK India Private Limited, Power Supply Division

Tel: +91 80 4039-0660  
mathew.philip@in.tdk-lambda.com  
www.sg.lambda.tdk.com

