



# MP4316

## 45V, 6A, Low $I_Q$ , Synchronous Step-Down Converter with Frequency Spread Spectrum

### DESCRIPTION

The MP4316 is a frequency-configurable, synchronous, step-down switching converter with integrated internal high-side and low-side power MOSFETs (HS-FET and LS-FET, respectively). It can achieve up to 6A of highly efficient, continuous output current ( $I_{OUT}$ ) with current control mode for fast loop response.

The wide 3.3V to 45V input voltage ( $V_{IN}$ ) range accommodates a variety of step-down applications in an automotive input environment. The device's 1.7 $\mu$ A shutdown current ( $I_{SD}$ ) makes it ideal for battery-powered applications.

The MP4316 provides high power conversion efficiency across the entire load range. Advanced asynchronous modulation (AAM) mode achieves high efficiency under light-load conditions by scaling down the switching frequency ( $f_{SW}$ ) to reduce the switching and gate driver losses.

An open-drain power good (PG) signal indicates whether the output is between 95% and 105% of its nominal voltage. High duty cycle and low-dropout (LDO) mode enable the device to withstand automotive cold-crank conditions.

Full protection features include frequency foldback to prevent inductor current ( $I_L$ ) runaway during start-up, over-current protection (OCP) with hiccup mode, and thermal shutdown for reliable, fault-tolerant operation.

The MP4316 is available in a QFN-20 (4mmx4mm) package.

### FEATURES

- Wide 3.3V to 45V Operating Input ( $V_{IN}$ ) Voltage Range
- Up to 6A of Continuous Output Current ( $I_{OUT}$ )
- Low 1.7 $\mu$ A Shutdown Current ( $I_{SD}$ )
- 18 $\mu$ A Sleep Mode Quiescent Current ( $I_Q$ )
- Internal 48m $\Omega$  and 20m $\Omega$  Power MOSFETs
- 350kHz to 1000kHz Configurable Switching Frequency ( $f_{SW}$ ) for Car Battery Applications
- External SYNC Clock
- Out-of-Phase Synchronized Clock Output
- Frequency Spread Spectrum (FSS) for Low Electromagnetic Interference (EMI)
- Symmetric  $V_{IN}$  for Low EMI
- Power Good (PG) Output
- External Soft Start (SS)
- 100ns Minimum On Time ( $t_{ON\_MIN}$ )
- Selectable Advanced Asynchronous Modulation (AAM) Mode or Forced Continuous Conduction Mode (FCCM)
- Low-Dropout (LDO) Mode
- Over-Current Protection (OCP) with Hiccup Mode
- Available in a QFN-20 (4mmx4mm) Package
- Available in a Wettable Flank Package

### APPLICATIONS

- Radios
- Battery-Powered Systems
- General-Purpose Consumer Applications
- Industrial Power Systems

All MPS parts are lead-free, halogen-free, and adhere to the RoHS directive. For MPS green status, please visit the MPS website under Quality Assurance. "MPS", the MPS logo, and "Simple, Easy Solutions" are trademarks of Monolithic Power Systems, Inc. or its subsidiaries.

## TYPICAL APPLICATION

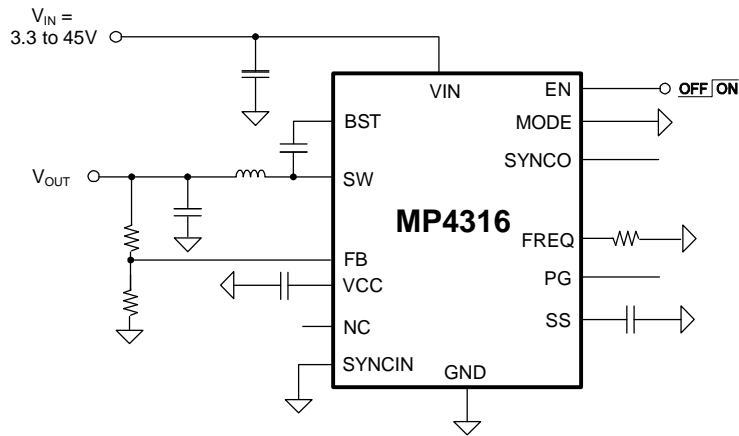

### Efficiency vs. Load Current

$V_{OUT} = 5V$ ,  $f_{sw} = 470kHz$ ,  $L = 4.7\mu H$ ,  
 $DCR = 15m\Omega$ , AAM

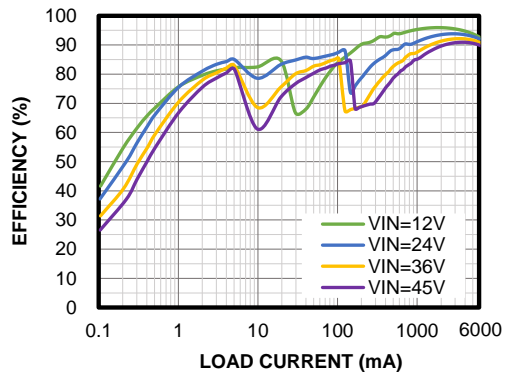

## ORDERING INFORMATION

Part Number*	Package	Top Marking	MSL Rating**
MP4316GRE***	QFN-20 (4mmx4mm)	See Below	1

\* For Tape & Reel, add suffix -Z (e.g. MP4316GRE-Z).

\*\* Moisture Sensitivity Level Rating

\*\*\* Wettable Flank

## TOP MARKING

MPSYWW

**MP4316**

**LLLLLL**

**E**

MPS: MPS prefix  
 Y: Year code  
 WW: Week code  
 MP4316: Part number  
 LLLLLL: Lot number  
 E: Wettable flank

## PACKAGE REFERENCE

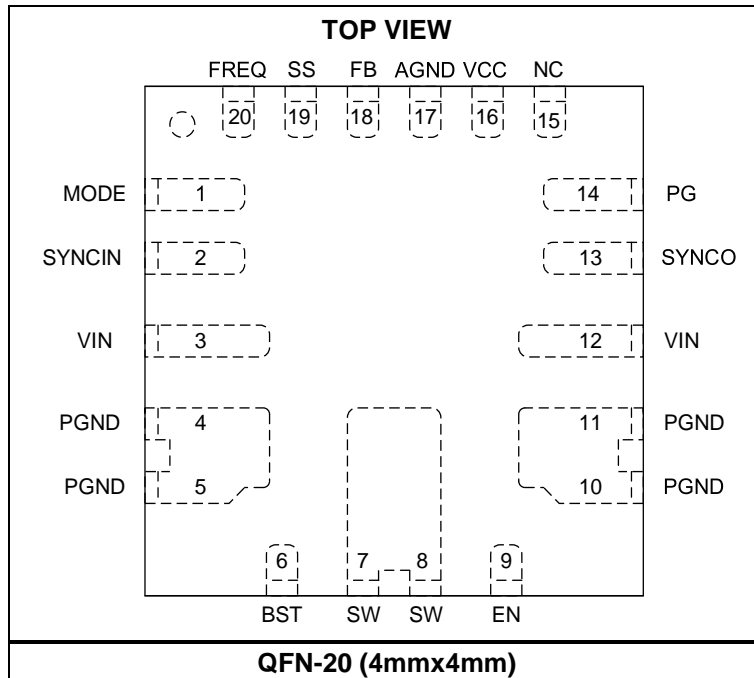

## PIN FUNCTIONS

Pin #	Name	Description
1	MODE	<b>Mode selection.</b> Pull the MODE pin high to make the converter operate in forced continuous conduction mode (FCCM). Pull MODE low to make the converter operate in advanced asynchronous modulation (AAM) mode. Do not float MODE.
2	SYNCIN	<b>Synchronous input.</b> Apply a 350kHz and 1000kHz clock signal to the SYNCIN pin to synchronize the internal oscillator frequency to the external clock. SYNCIN has an internal high impedance (Hi-Z). If using SYNCIN, ensure that the external SYNC clock has an adequate pull-up and pull-down resistance. If the external clock's pull-down resistance is not sufficient, or if SYNCIN enters a Hi-Z state, place a $\leq 51k\Omega$ resistor between the SYNCIN pin and AGND. Do not float SYNCIN.
3, 12	VIN	<b>Input supply.</b> The VIN pin powers the internal circuitry and the high-side MOSFET (HS-FET) connected to the SW pin. To minimize switching spikes at the input, connect a decoupling capacitor between the VIN pin and PGND. Place this capacitor close to VIN.
4, 5, 10, 11	PGND	<b>Power ground.</b>
6	BST	<b>Bootstrap.</b> The BST pin is the positive power supply for the HS-FET. Connect a bypass capacitor between the BST and SW pins. For more information, see the Selecting the External Bootstrap (BST) Diode and Resistor section on page 32.
7, 8	SW	<b>Switch output.</b> The SW pin is the output of the internal power MOSFETs.
9	EN	<b>Enable.</b> Pull the EN pin above 1V to turn the converter on; pull EN below 0.85V to turn it off.
13	SYNCO	<b>Synchronous output.</b> The SYNCO pin outputs a clock that is 180° out-of-phase with the internal oscillator. SYNCO can also output a signal opposite of the clock applied at the SYNCIN pin. Float SYNCO if not used.
14	PG	<b>Power good indicator.</b> The PG pin is an open-drain output. Connect PG to a power source via a pull-up resistor. If the output voltage ( $V_{OUT}$ ) is between 95% and 105% of the nominal voltage, PG is pulled high. If $V_{OUT}$ exceeds 106.5% or drops below 93% of the nominal voltage, PG is pulled low.
15	NC	<b>Not connected.</b> Float the NC pin if not used.
16	VCC	<b>Bias supply.</b> The VCC pin supplies 4.9V to the internal control circuit and gate drivers. Connect a decoupling capacitor from VCC to AGND. Place this capacitor close to VCC. For information, see the Selecting the VCC Capacitor ( $C_{VCC}$ ) section on page 32.
17	AGND	<b>Analog ground.</b>
18	FB	<b>Feedback input.</b> To set $V_{OUT}$ , connect the FB pin to the center of the external resistor divider connected between the output and AGND. The feedback (FB) voltage ( $V_{FB}$ ) is about 0.815V. Place the resistor divider as close to FB as possible. Keep vias away from the FB traces.
19	SS	<b>Soft-start input.</b> Place a capacitor between the SS pin and AGND to set the soft-start time ( $t_{SS}$ ). During start-up, SS provides 13 $\mu$ A to the soft-start capacitor ( $C_{SS}$ ). As the SS voltage ( $V_{SS}$ ) increases, $V_{FB}$ increases to limit the input inrush current during start-up.
20	FREQ	<b>Switching frequency setting.</b> Connect a resistor from the FREQ pin to AGND to set the switching frequency ( $f_{SW}$ ). For more information, see the $f_{SW}$ vs. $R_{FREQ}$ curves on page 15.

**ABSOLUTE MAXIMUM RATINGS** <sup>(1)</sup>

VIN, EN .....	-0.3V to +50V
SW .....	-0.3V to VIN_MAX + 0.3V
BST .....	VSW + 5.5V
All other pins.....	-0.3V to +5.5V
Continuous power dissipation (TA = 25°C) <sup>(2) (5)</sup>	
QFN-20 (4mmx4mm).....	5.4W
Operating junction temperature.....	150°C
Lead temperature .....	260°C
Storage temperature.....	-65°C to +150°C

**ESD Ratings**

Human body model (HBM) .....	±2kV
Charged device model (CDM).....	±750V

**Recommended Operating Conditions**

Input voltage (VIN) .....	3.3V to 45V
Output voltage (VOUT).....	0.815V to 0.95 x VIN
Operating junction temp (TJ) .....	-40°C to +125°C <sup>(3)</sup>

<b>Thermal Resistance</b>	<b>θJA</b>	<b>θJC</b>
QFN-20 (4mmx4mm)		
JESD51-7 <sup>(4)</sup> .....	44.....	9.....°C/W
EVQ4316-R-00A <sup>(5)</sup> .....	23.....	2.5.....°C/W

**Notes:**

- 1) Exceeding these ratings may damage the device.
- 2) The maximum allowable power dissipation is a function of the maximum junction temperature TJ (MAX), the junction-to-ambient thermal resistance θJA, and the ambient temperature TA. The maximum allowable continuous power dissipation at any ambient temperature is calculated by PD (MAX) = (TJ (MAX) - TA) / θJA. Exceeding the maximum allowable power dissipation can cause excessive die temperature, and the converter may go into thermal shutdown. Internal thermal shutdown circuitry protects the device from permanent damage.
- 3) An operating junction temperature above 125°C may be supported. Contact MPS for details.
- 4) Measured on JESD51-7, 4-layer PCB. The values given in this table are only valid for comparison with other packages and cannot be used for design purposes. These values were calculated in accordance with JESD51-7, and simulated on a specified JEDEC board. They do not represent the performance obtained in an actual application.
- 5) Measured on an MPS standard evaluation board (9cmx9cm), thick 2oz copper, 4-layer PCB.

## ELECTRICAL CHARACTERISTICS

$V_{IN} = 12V$ ,  $V_{EN} = 2V$ ,  $T_J = -40^{\circ}C$  to  $+125^{\circ}C$  <sup>(6)</sup>, typical values are at  $T_J = 25^{\circ}C$ , unless otherwise noted.

Parameter	Symbol	Condition	Min	Typ	Max	Units
$V_{IN}$ under-voltage lockout (UVLO) rising threshold	$V_{IN\_UVLO\_RISING}$		2.8	3	3.2	V
$V_{IN}$ UVLO falling threshold	$V_{IN\_UVLO\_FALLING}$		2.5	2.7	2.9	V
$V_{IN}$ UVLO hysteresis	$V_{IN\_UVLO\_HYS}$			280		mV
VCC voltage	$V_{CC}$	$I_{VCC} = 0A$	4.6	4.9	5.2	V
VCC voltage regulation		$I_{VCC} = 30mA$		1	4	%
VCC current limit	$I_{LIMIT\_VCC}$	$V_{CC} = 4V$	100			mA
Quiescent current during sleep mode	$I_{SLEEP}$	$V_{FB} = 0.85V$ , sleep mode, no load		18	26	$\mu A$
Quiescent current <sup>(7)</sup>	$I_Q$	MODE is low, advanced asynchronous modulation (AAM) mode, no load, switching, $R_{FB\_PU} = 1M\Omega$ , $R_{FB\_PD} = 324k\Omega$		20		$\mu A$
		MODE is high, forced continuous conduction mode (FCCM), switching, no load, $f_{SW} = 2MHz$		40		mA
		MODE is high, FCCM, no load, switching, $f_{SW} = 470kHz$		9.5		mA
Shutdown current	$I_{SD}$	$V_{EN} = 0V$		1.7	3.5	$\mu A$
Feedback (FB) voltage	$V_{FB}$	$V_{IN} = 3.3V$ to $45V$ , $T_J = 25^{\circ}C$	0.807	0.815	0.823	V
		$V_{IN} = 3.3V$ to $45V$	0.799	0.815	0.831	V
FB current	$I_{FB}$	$V_{FB} = 0.85V$	-50	0	+50	nA
Switching frequency	$f_{SW}$	$R_{FREQ} = 62k\Omega$	420	470	520	kHz
		$R_{FREQ} = 26.1k\Omega$	820	1000	1180	
Minimum on time <sup>(7)</sup>	$t_{ON\_MIN}$			100		ns
Minimum off time <sup>(7)</sup>	$t_{OFF\_MIN}$			80		ns
SYNCIN voltage rising threshold	$V_{SYNC\_RISING}$		1.8			V
SYNCIN voltage falling threshold	$V_{SYNC\_FALLING}$				0.4	V
SYNCIN clock range	$f_{SYNC}$	External clock	350		1000	kHz
SYNCO high voltage	$V_{SYNCO\_HIGH}$	$I_{SYNCO} = -1mA$	3.3	4.5		V
SYNCO low voltage	$V_{SYNCO\_LOW}$	$I_{SYNCO} = 1mA$			0.4	V
SYNCO phase shift		Tested under SYNCIN		180		Deg
High-side MOSFET (HS-FET) peak current limit	$I_{LIMIT\_PEAK}$	30% duty cycle	10	13	16	A
Low-side MOSFET (LS-FET) valley current limit	$I_{LIMIT\_VALLEY}$		8	10	12	A
Zero-current detection (ZCD) current	$I_{ZCD}$	AAM mode	-0.15	0.1	+0.35	A
LS reverse current limit	$I_{LIMIT\_REVERSE}$	FCCM	2	4.5	7	A
Switch leakage current	$I_{SW\_LKG}$			0.01	1	$\mu A$
HS-FET on resistance	$R_{DS(ON)\_HS}$	$V_{BST} - V_{SW} = 5V$		48	80	m $\Omega$
LS-FET on resistance	$R_{DS(ON)\_LS}$	$V_{CC} = 5V$		20	40	m $\Omega$
Soft-start current	$I_{SS}$	$V_{SS} = 0V$	8	13	19	$\mu A$
EN rising threshold	$V_{EN\_RISING}$		0.8	1	1.2	V
EN falling threshold	$V_{EN\_FALLING}$		0.65	0.85	1.05	V
EN hysteresis	$V_{EN\_HYS}$			190		mV
MODE rising threshold	$V_{MODE\_RISING}$		1.8			V
MODE falling threshold	$V_{MODE\_FALLING}$				0.4	V

**ELECTRICAL CHARACTERISTICS (continued)**
 $V_{IN} = 12V$ ,  $V_{EN} = 2V$ ,  $T_J = -40^{\circ}C$  to  $+125^{\circ}C$  <sup>(6)</sup>, typical values are at  $T_J = 25^{\circ}C$ , unless otherwise noted.

Parameter	Symbol	Condition	Min	Typ	Max	Units
PG rising threshold	$V_{PG\_RISING}$	$V_{FB}$ rising, $V_{FB} / V_{REF}$	92	95	98	% of $V_{REF}$
		$V_{FB}$ falling, $V_{FB} / V_{REF}$	102	105	108	
PG falling threshold	$V_{PG\_FALLING}$	$V_{FB}$ falling, $V_{FB} / V_{REF}$	90.5	93.5	96.5	
		$V_{FB}$ rising, $V_{FB} / V_{REF}$	103.5	106.5	109.5	
PG output low voltage	$V_{PG\_LOW}$	$I_{SINK} = 1mA$		0.1	0.3	V
PG rising delay	$t_{PG\_DELAY\_RISING}$			35		$\mu s$
PG falling delay	$t_{PG\_DELAY\_FALLING}$			35		$\mu s$
Thermal shutdown <sup>(7)</sup>	$T_{SD}$			170		$^{\circ}C$
Thermal shutdown hysteresis <sup>(7)</sup>	$T_{SD\_HYS}$			20		$^{\circ}C$

**Notes:**

- 6) Guaranteed by over-temperature correlation. Not tested in production.  
 7) Derived from bench characterization. Not tested in production.

## TYPICAL CHARACTERISTICS

$V_{IN} = 12V$ ,  $T_J = -40^{\circ}C$  to  $+125^{\circ}C$ , unless otherwise noted.

Quiescent Current vs. Temperature

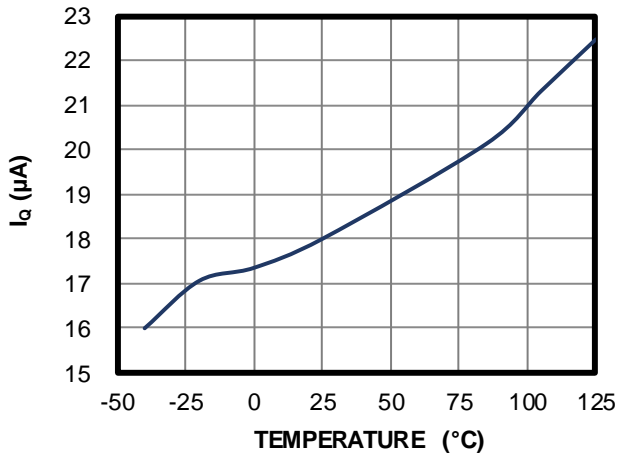

Feedback Voltage vs. Temperature

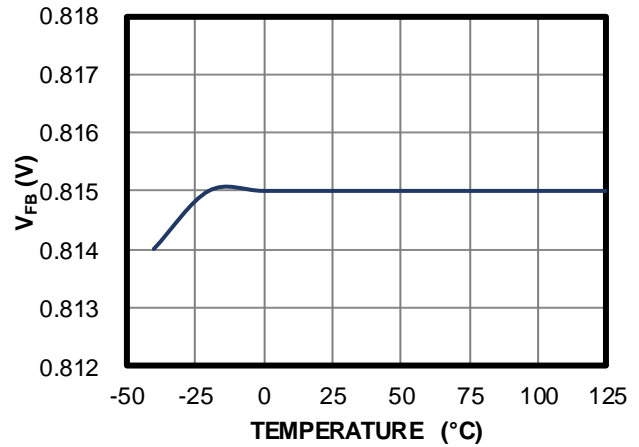

Current Limit vs. Temperature

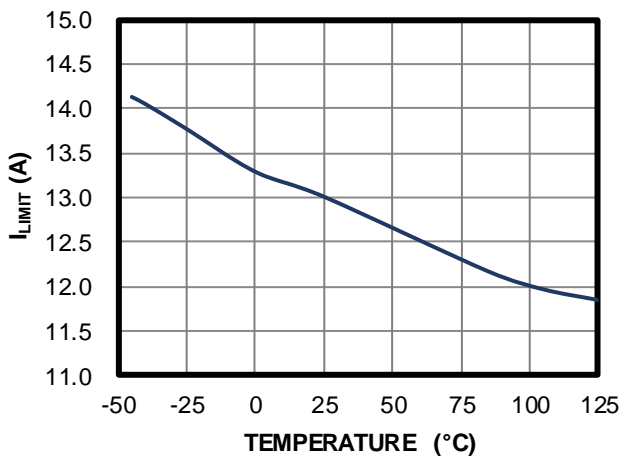

Valley Current Limit vs. Temperature

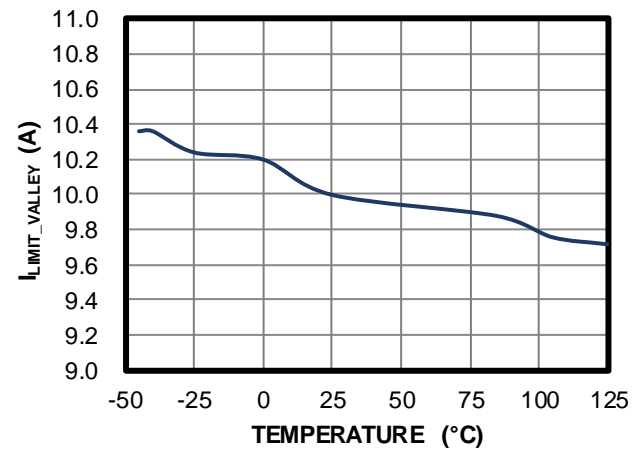

Reverse Current Limit vs. Temperature

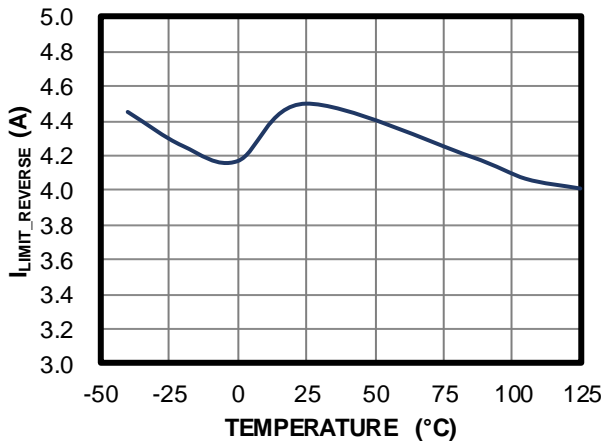

$V_{IN}$  UVLO Threshold vs. Temperature

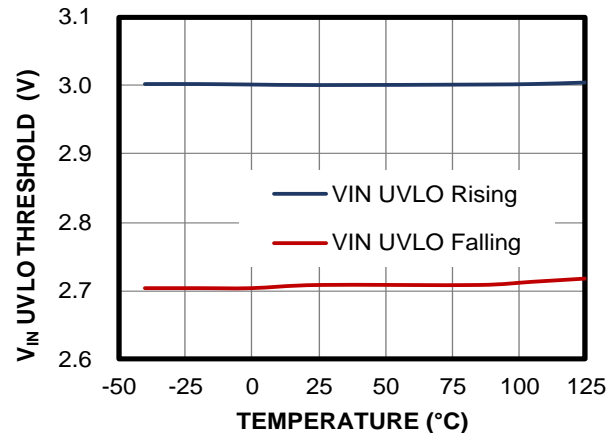

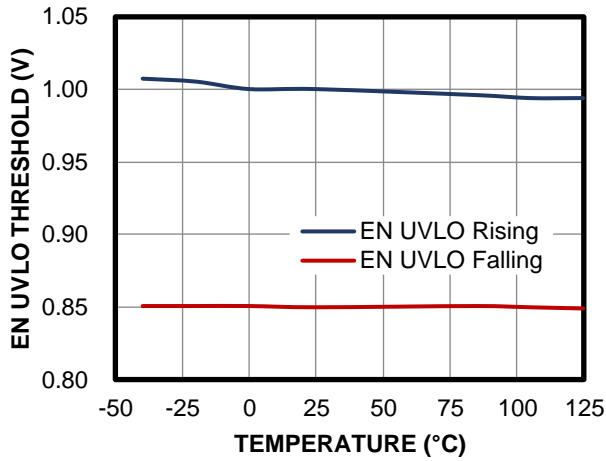
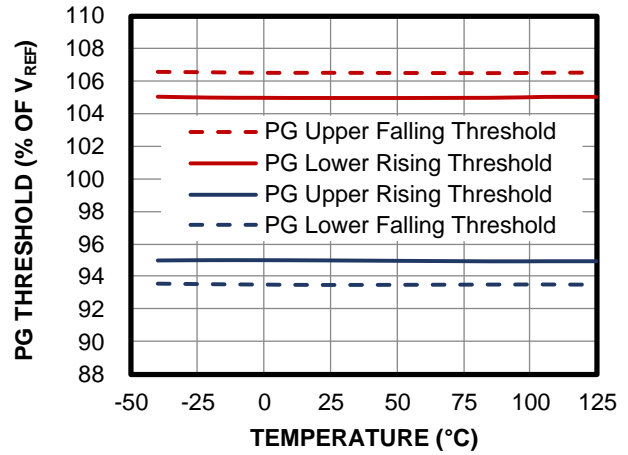
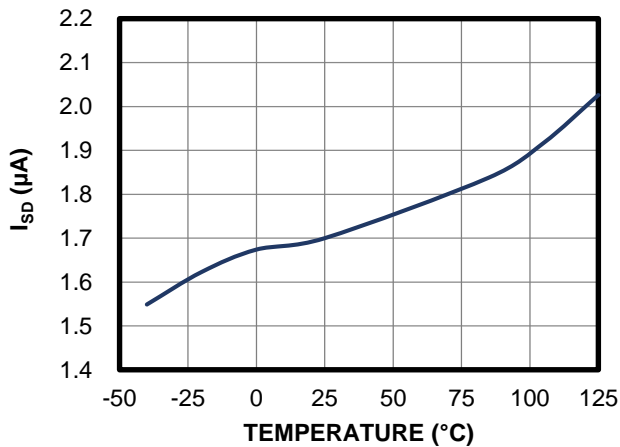
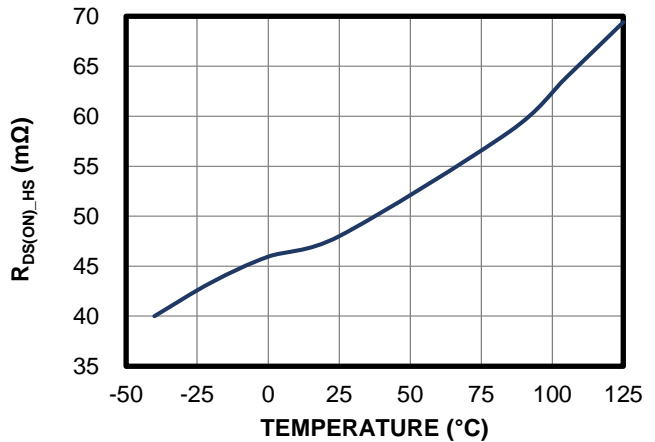
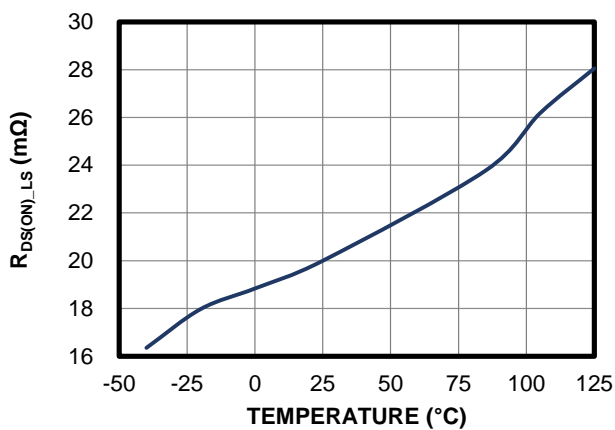
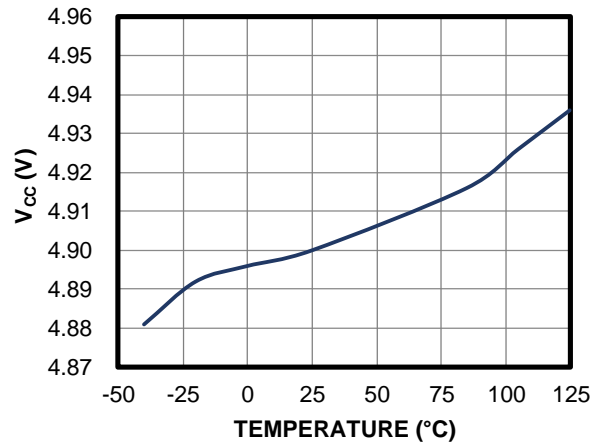

**TYPICAL CHARACTERISTICS (continued)**
 $V_{IN} = 12V$ ,  $T_J = -40^{\circ}C$  to  $+125^{\circ}C$ , unless otherwise noted.

**EN UVLO Threshold vs. Temperature**

**PG Threshold vs. Temperature**

**Shutdown Current vs. Temperature**

**HS-FET On Resistance vs. Temperature**

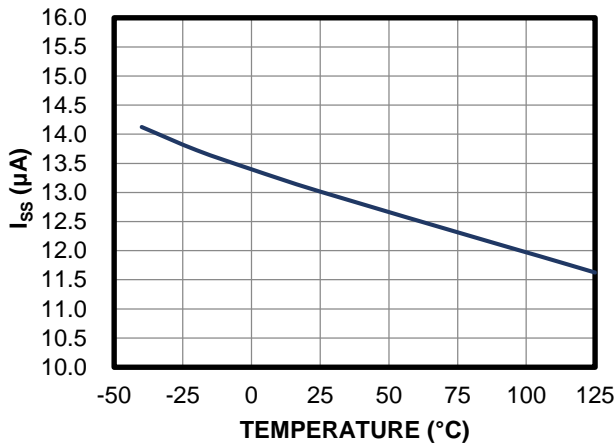
**LS-FET On Resistance vs. Temperature**

 **$V_{CC}$  vs. Temperature**

## TYPICAL CHARACTERISTICS (continued)

$V_{IN} = 12V$ ,  $T_J = -40^{\circ}C$  to  $+125^{\circ}C$ , unless otherwise noted.

**Soft-Start Current vs. Temperature**



**Zero-Current Detection vs. Temperature**

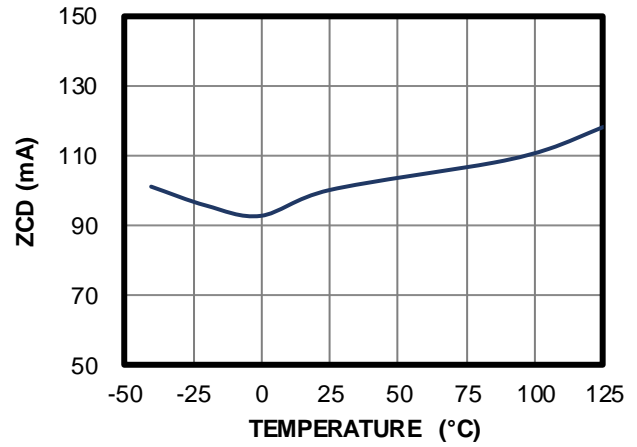

**Switching Frequency vs. Temperature**

$R_{FREQ} = 62k\Omega$

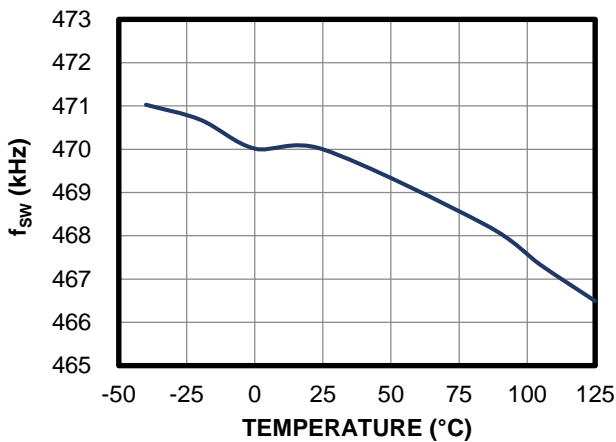

## TYPICAL PERFORMANCE CHARACTERISTICS

$V_{IN} = 12V$ ,  $V_{OUT} = 3.3V$ ,  $L = 4.7\mu H$  <sup>(8)</sup>,  $f_{sw} = 470kHz$ , AAM mode,  $T_A = 25^\circ C$ , unless otherwise noted.

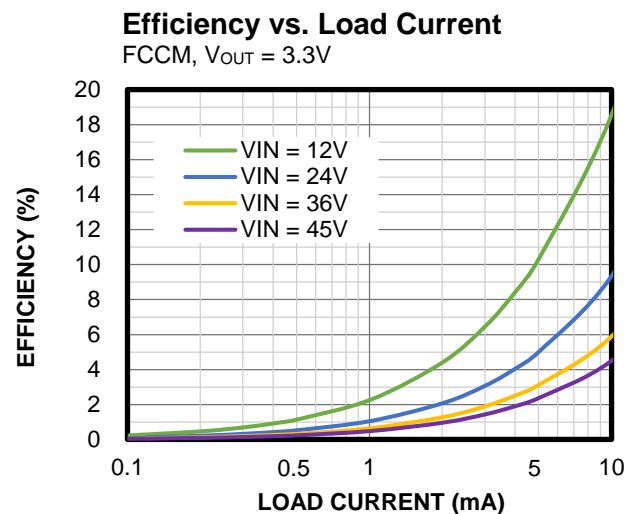
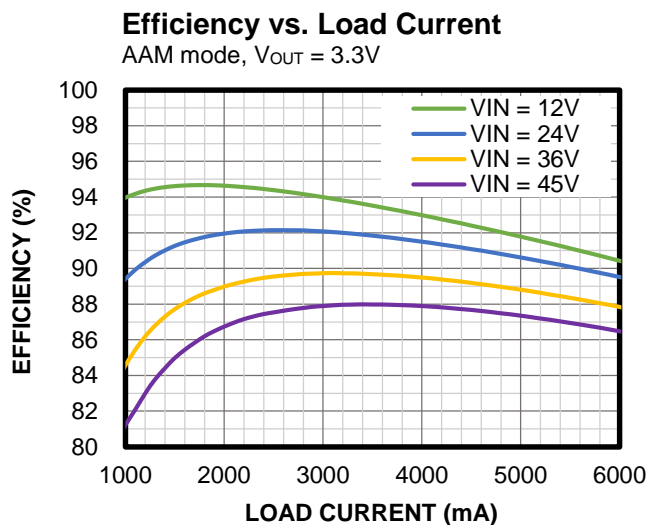
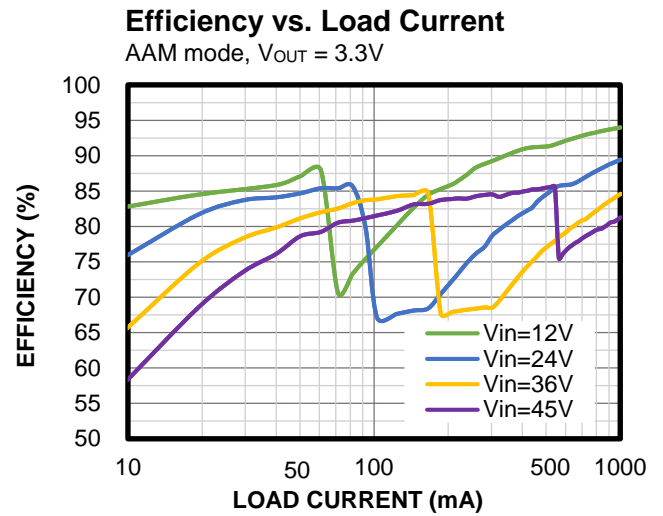
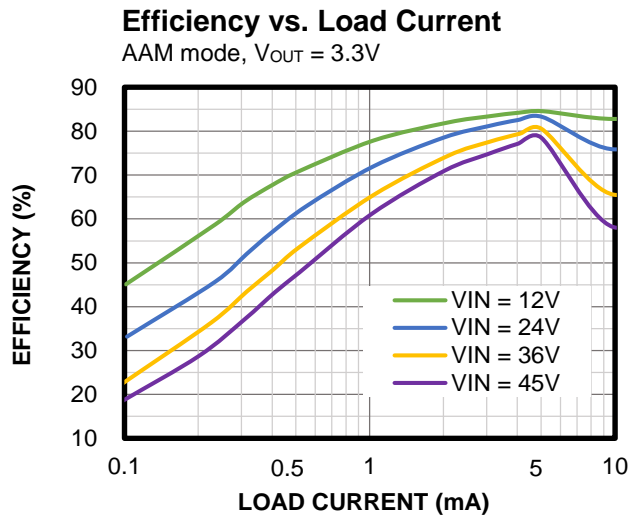
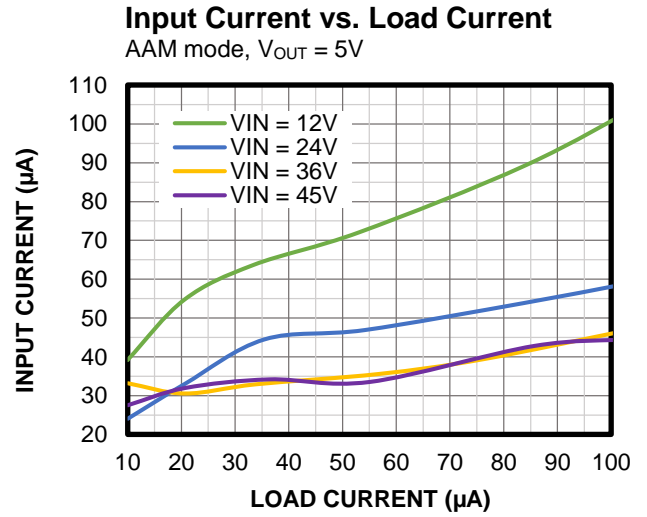
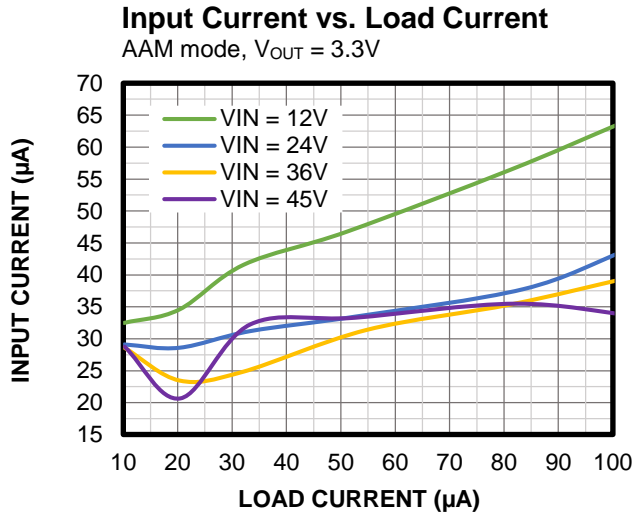

## TYPICAL PERFORMANCE CHARACTERISTICS

$V_{IN} = 12V$ ,  $V_{OUT} = 3.3V$ ,  $L = 4.7\mu H$  <sup>(8)</sup>,  $f_{sw} = 470kHz$ , AAM mode,  $T_A = 25^\circ C$ , unless otherwise noted.

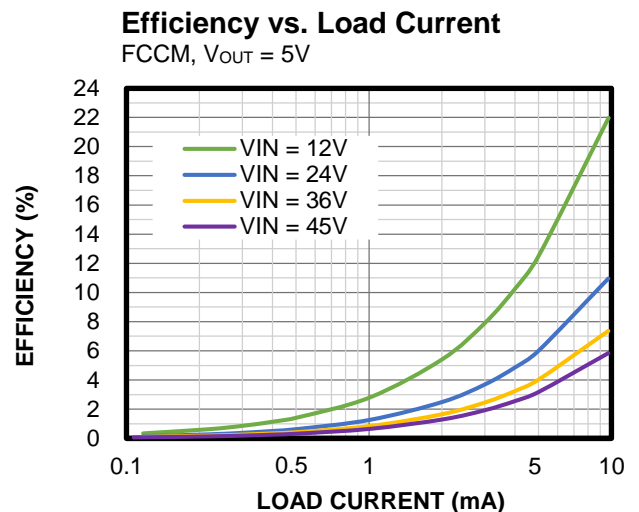
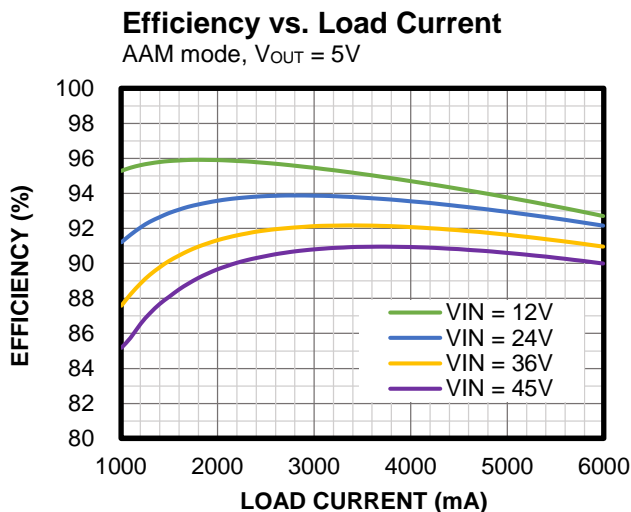
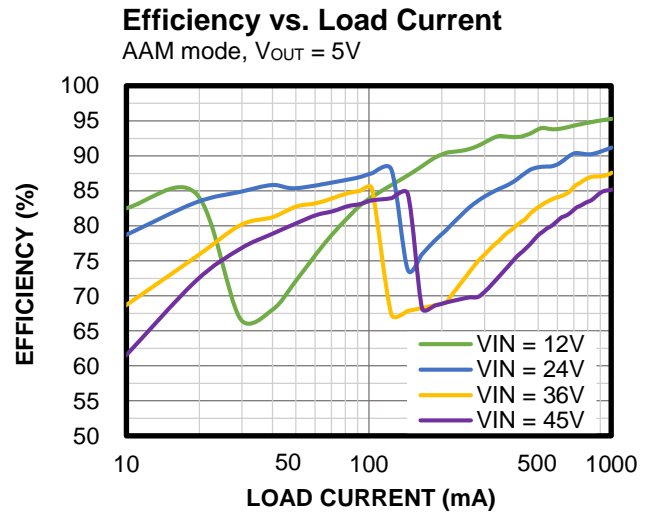
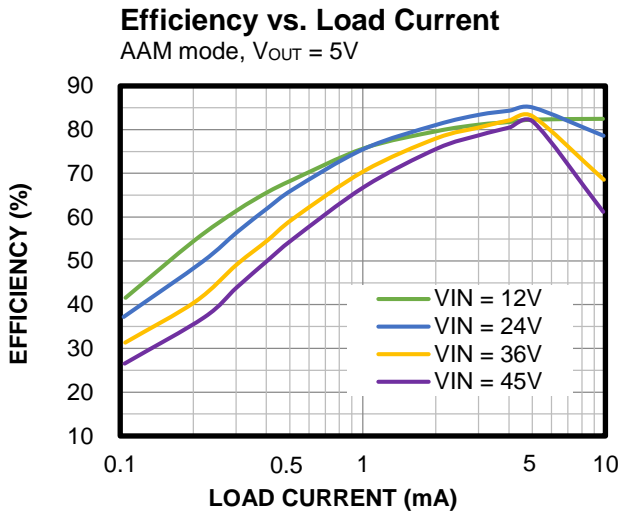
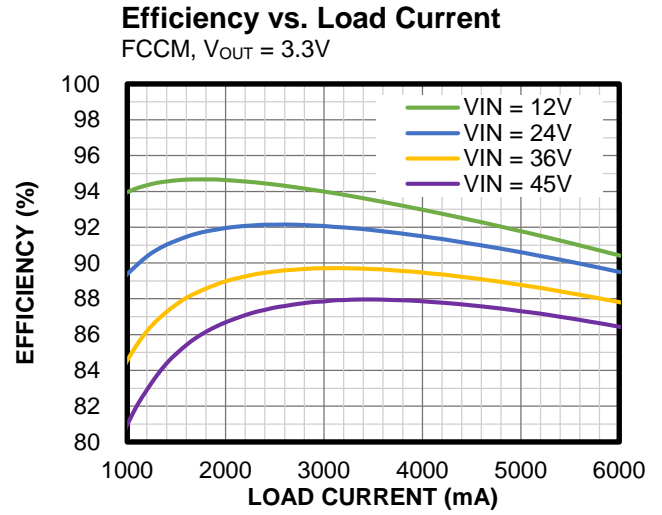
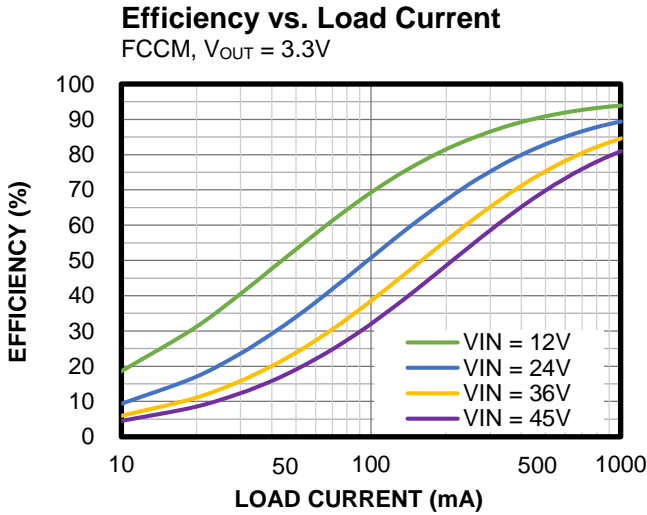

## TYPICAL PERFORMANCE CHARACTERISTICS

$V_{IN} = 12V$ ,  $V_{OUT} = 3.3V$ ,  $L = 4.7\mu H$  <sup>(8)</sup>,  $f_{sw} = 470kHz$ , AAM mode,  $T_A = 25^\circ C$ , unless otherwise noted.

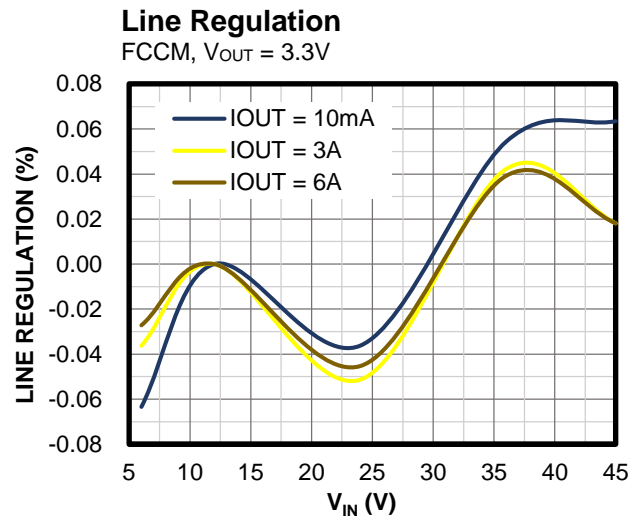
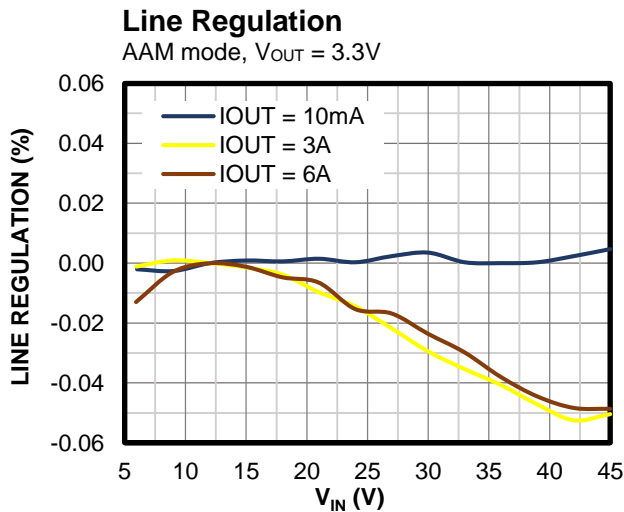
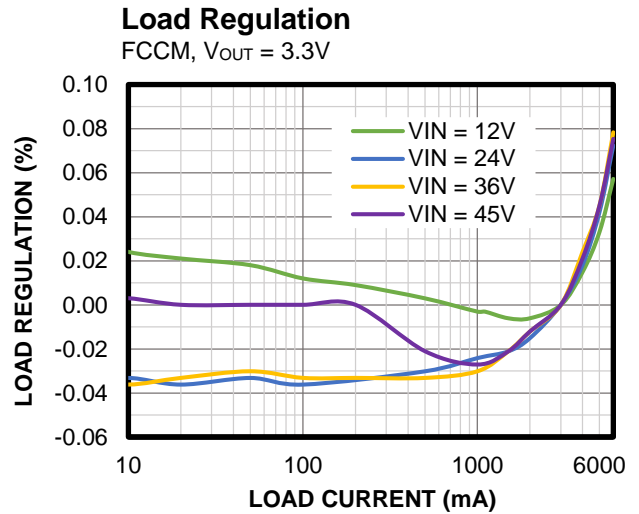
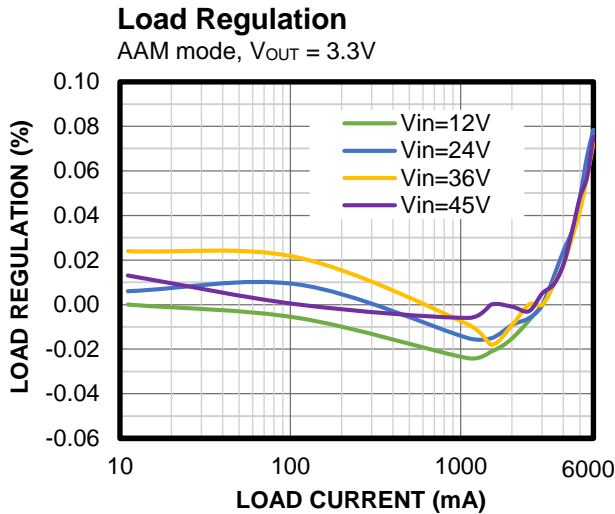
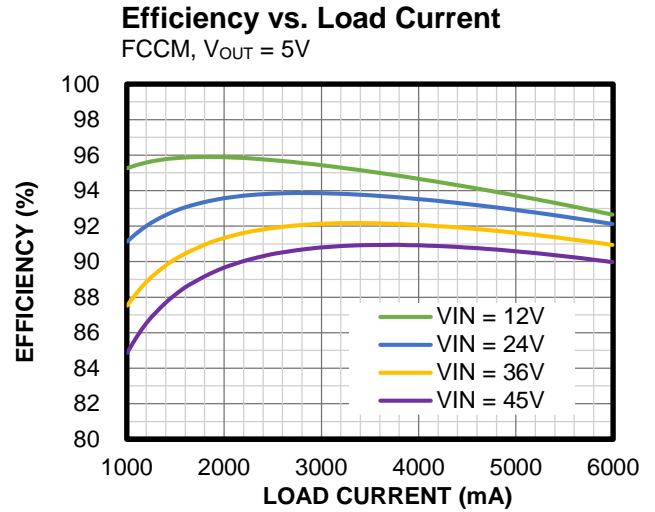
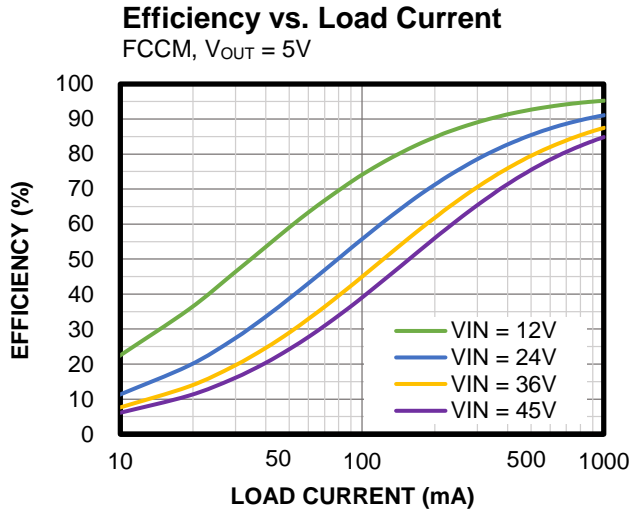

**TYPICAL PERFORMANCE CHARACTERISTICS (continued)**
 $V_{IN} = 12V$ ,  $V_{OUT} = 3.3V$ ,  $L = 4.7\mu H$  <sup>(8)</sup>,  $f_{sw} = 470kHz$ , AAM mode,  $T_A = 25^\circ C$ , unless otherwise noted.

**Load Regulation**

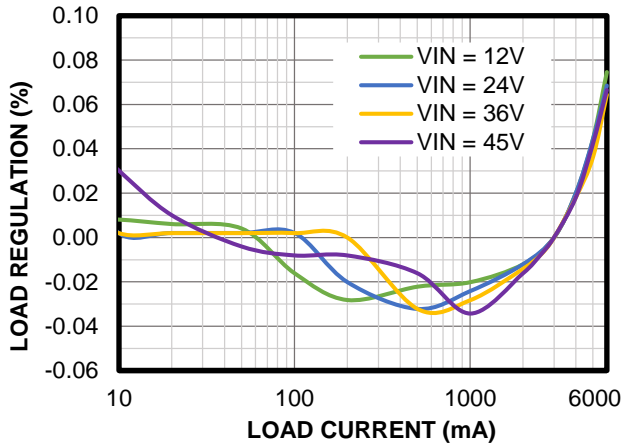
 AAM mode,  $V_{OUT} = 5V$ 

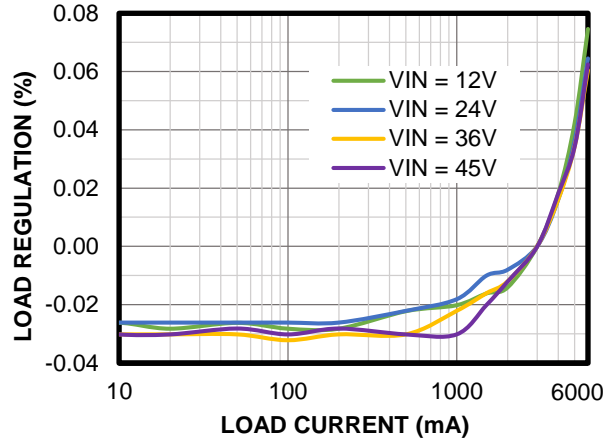
**Load Regulation**

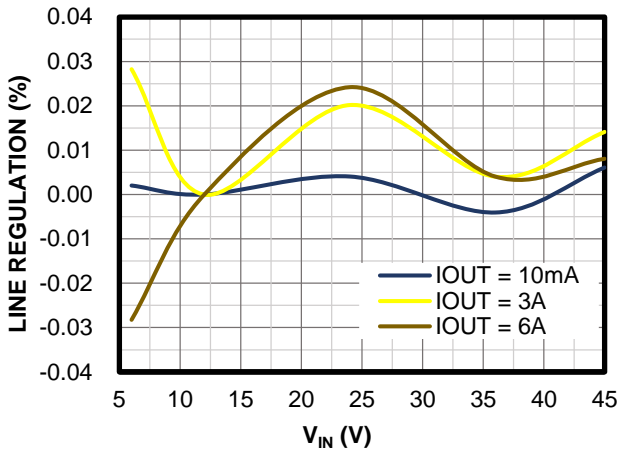
 FCCM,  $V_{OUT} = 5V$ 

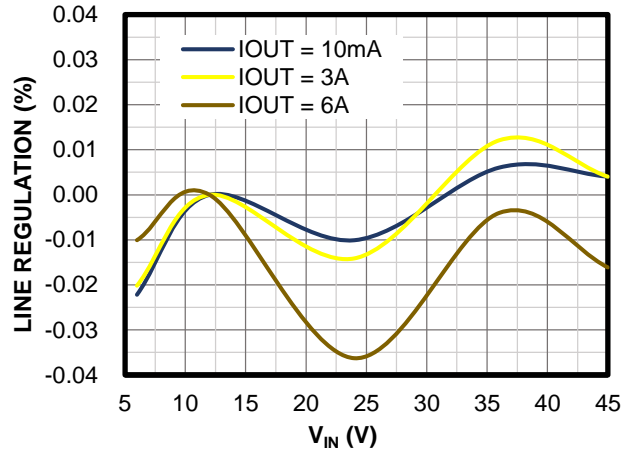
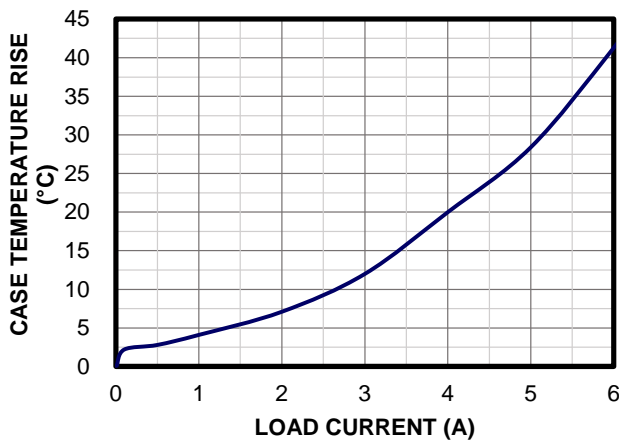
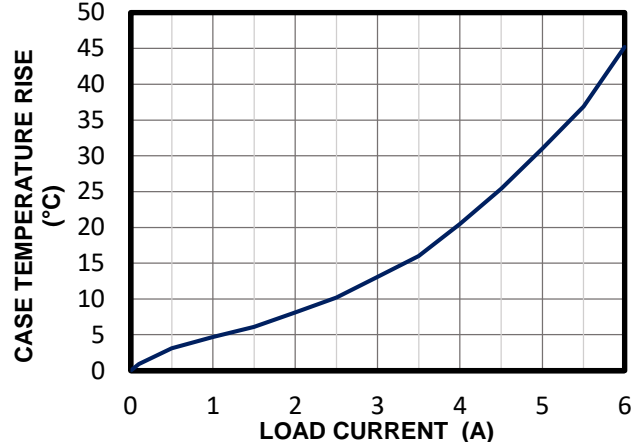
**Line Regulation**

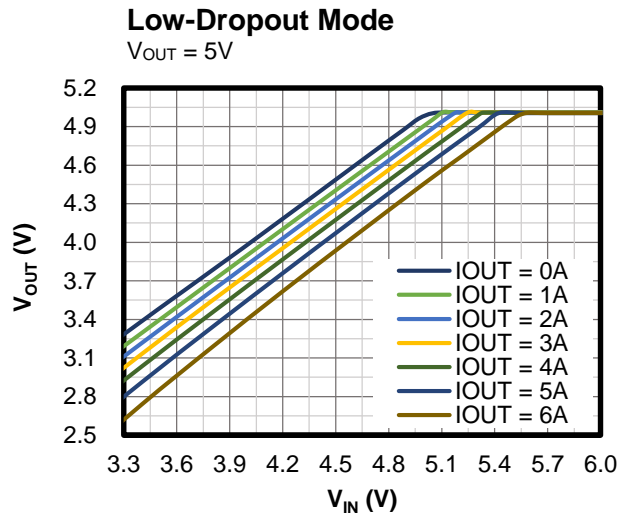
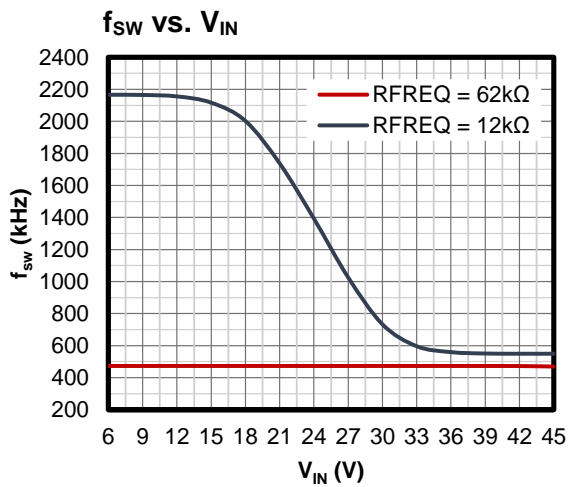
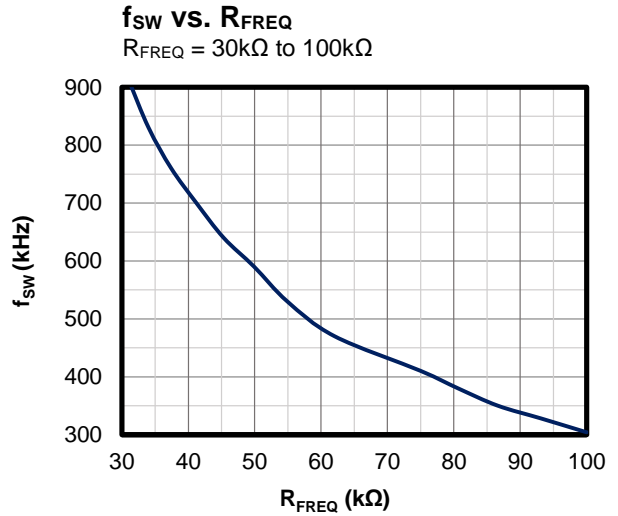
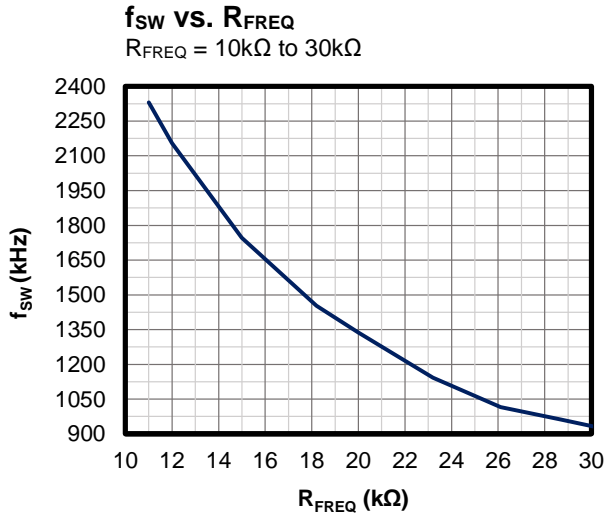
 AAM mode,  $V_{OUT} = 5V$ 

**Line Regulation**

 FCCM,  $V_{OUT} = 5V$ 

**Case Temperature Rise**
 $V_{OUT} = 3.3V$ 

**Case Temperature Rise**
 $V_{OUT} = 5V$ 

**TYPICAL PERFORMANCE CHARACTERISTICS (continued)**
 $V_{IN} = 12V$ ,  $V_{OUT} = 3.3V$ ,  $L = 4.7\mu H$  <sup>(8)</sup>,  $f_{sw} = 470kHz$ , AAM mode,  $T_A = 25^\circ C$ , unless otherwise noted.

## TYPICAL PERFORMANCE CHARACTERISTICS *(continued)*

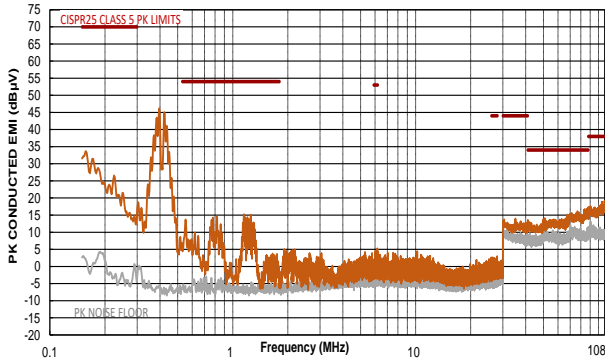
$V_{IN} = 12V$ ,  $V_{OUT} = 5V$ ,  $I_{OUT} = 6A$ ,  $L = 4.7\mu H$  <sup>(8)</sup>,  $f_{SW} = 410kHz$ ,  $T_A = 25^\circ C$ , unless otherwise noted. <sup>(9)</sup>

**CISPR25 Class 5 Peak Conducted Emissions**  
150kHz to 108MHz



**CISPR25 Class 5 Average Conducted Emissions**  
150kHz to 108MHz

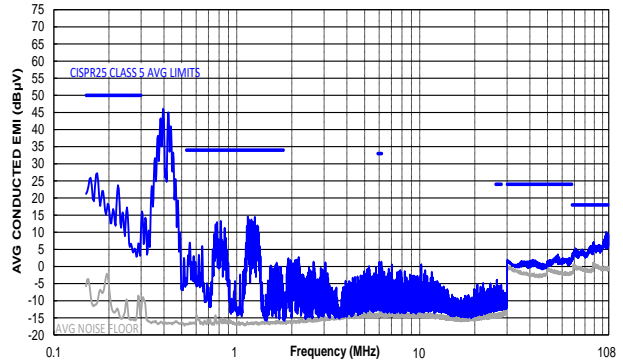

**CISPR25 Class 5 Peak Radiated Emissions**  
150kHz to 30MHz

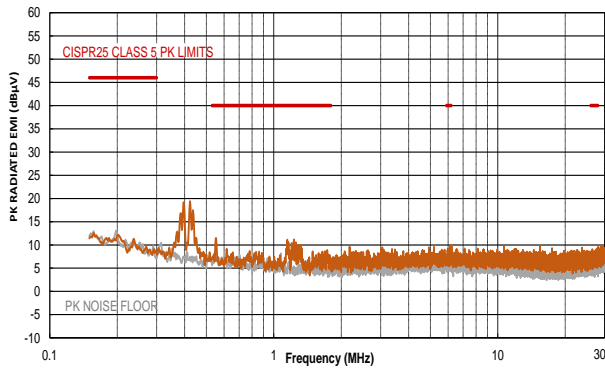

**CISPR25 Class 5 Average Radiated Emissions**  
150kHz to 30MHz

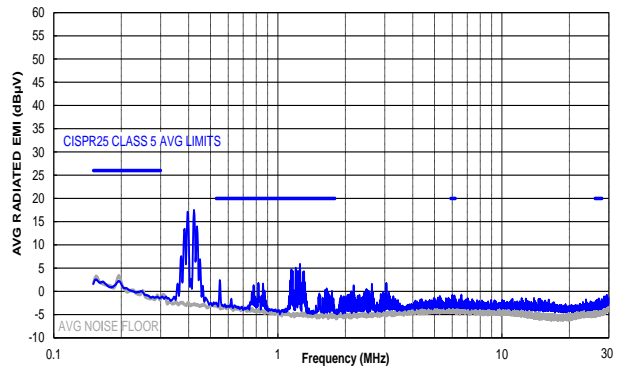

**CISPR25 Class 5 Peak Radiated Emissions**  
Horizontal, 30MHz to 1GHz

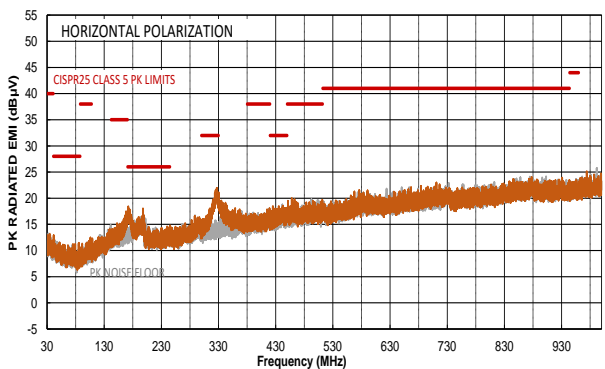

**CISPR25 Class 5 Average Radiated Emissions**  
Horizontal, 30MHz to 1GHz

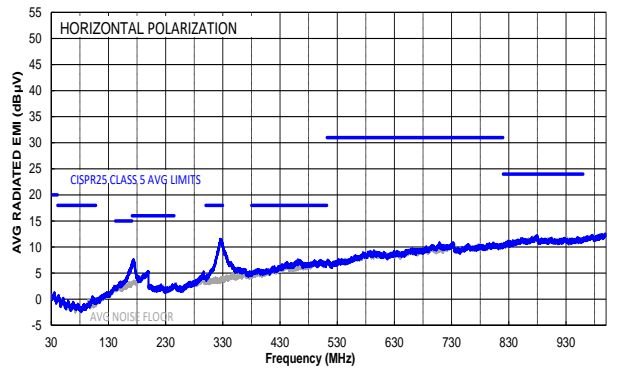



## TYPICAL PERFORMANCE CHARACTERISTICS *(continued)*

$V_{IN} = 12V$ ,  $V_{OUT} = 5V$ ,  $I_{OUT} = 6A$ ,  $L = 4.7\mu H$ <sup>(8)</sup>,  $f_{SW} = 410kHz$ ,  $T_A = 25^\circ C$ , unless otherwise noted.<sup>(9)</sup>

### CISPR25 Class 5 Peak Radiated Emissions

Vertical, 30MHz to 1GHz

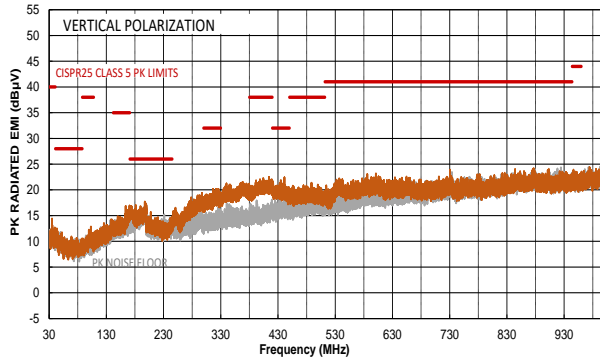

### CISPR25 Class 5 Average Radiated Emissions

Vertical, 30MHz to 1GHz

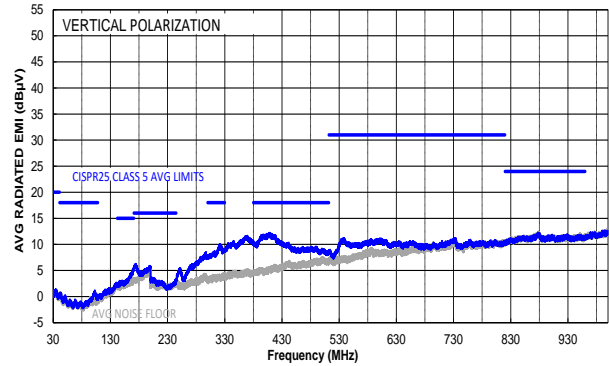

#### Notes:

- 8) Inductor part number: XAL6060-472MEC (DCR = 15mΩ).
- 9) The EMC test results are based on Figure 11 on page 35.

**TYPICAL PERFORMANCE CHARACTERISTICS (continued)**
 $V_{IN} = 12V$ ,  $V_{OUT} = 3.3V$ ,  $L = 4.7\mu H$ ,  $f_{sw} = 470kHz$ , AAM,  $T_A = 25^\circ C$ , unless otherwise noted.

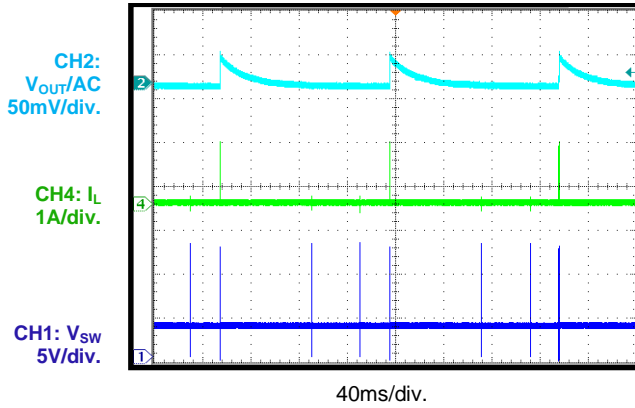
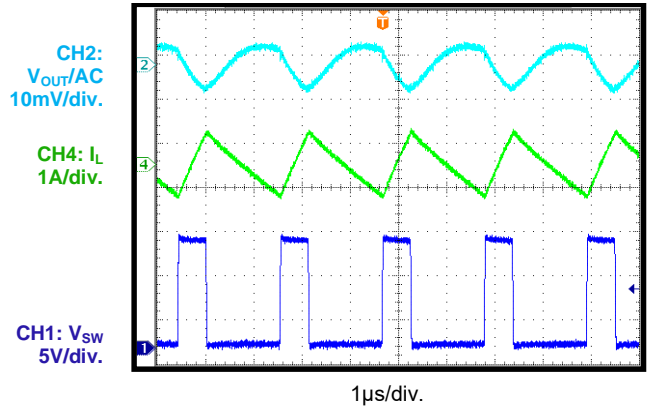
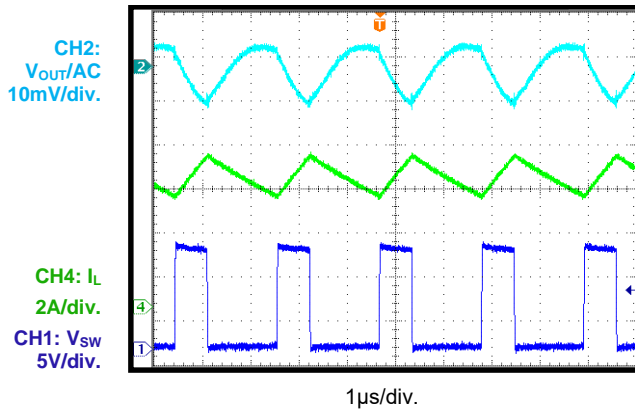
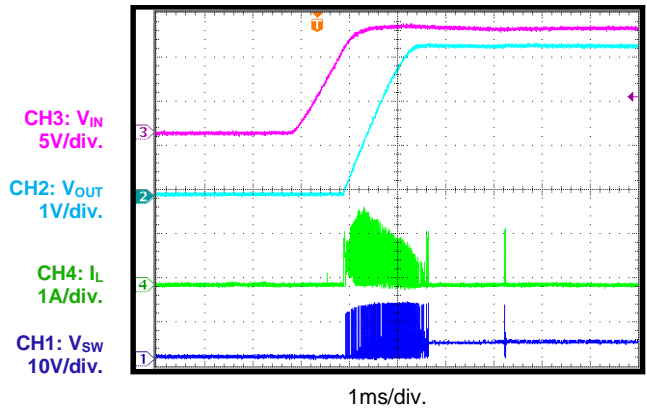
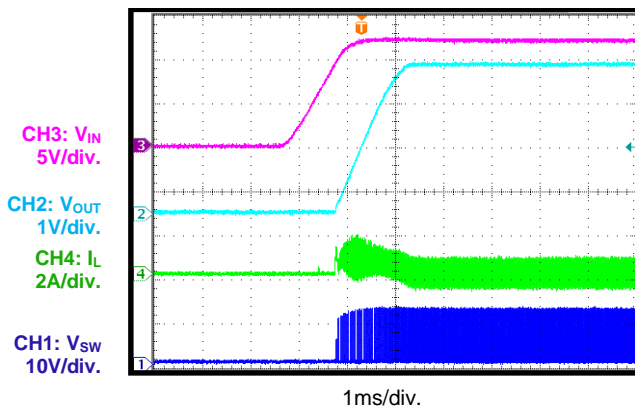
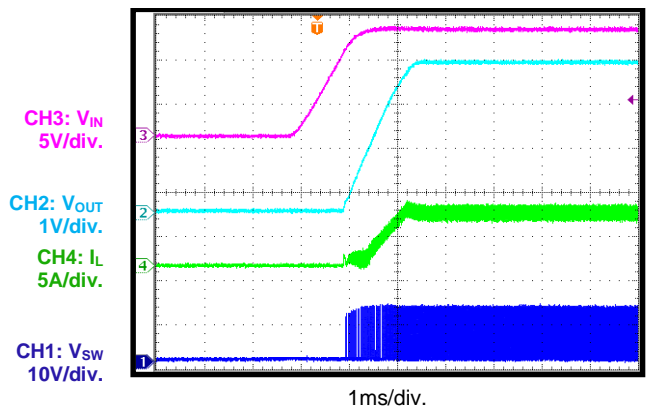
**Steady State**
 $I_{OUT} = 0A$ , AAM mode

**Steady State**
 $I_{OUT} = 0A$ , FCCM

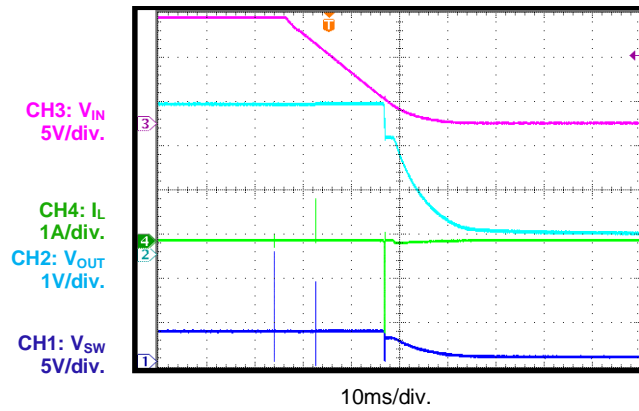
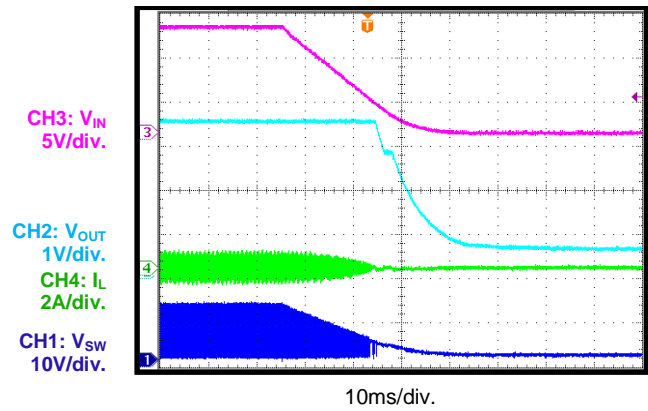
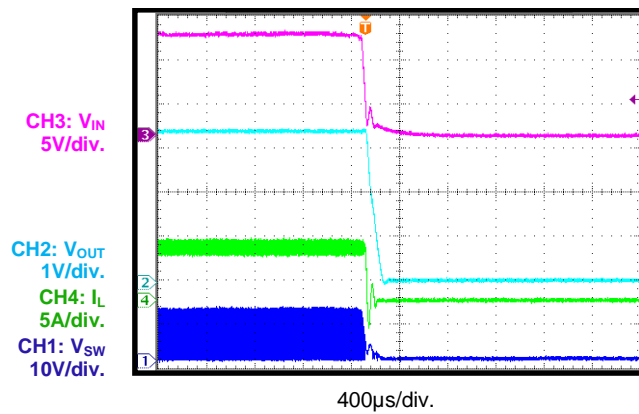
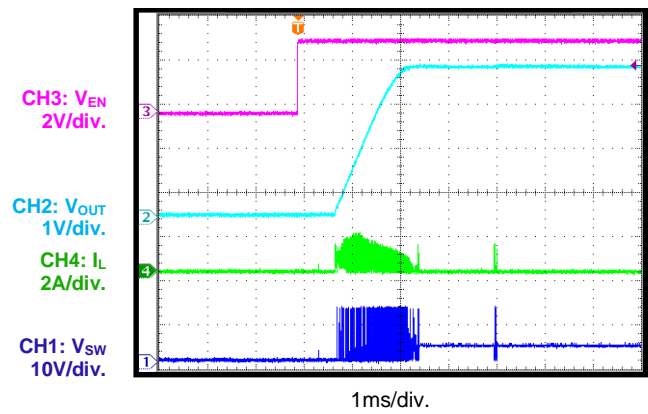
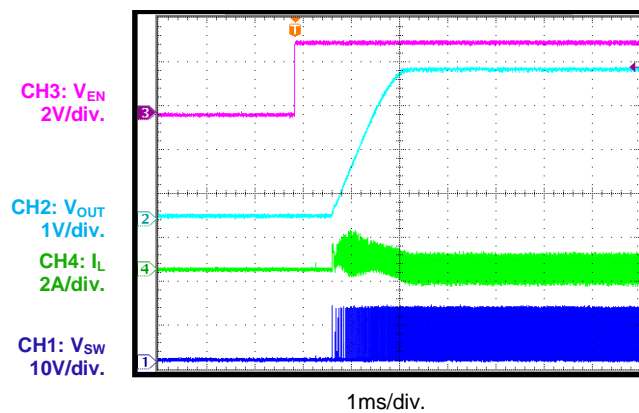
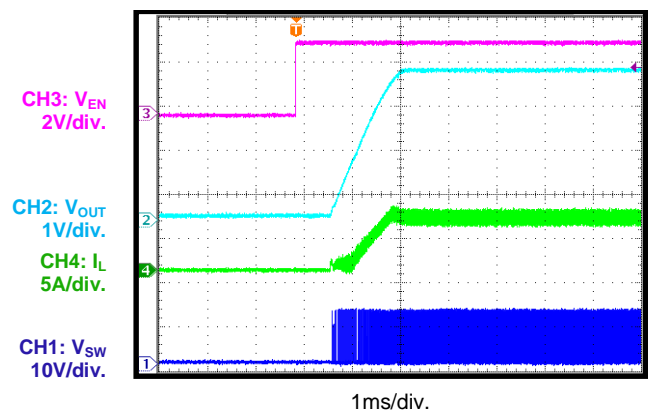
**Steady State**
 $I_{OUT} = 6A$ 

**Start-Up through VIN**
 $I_{OUT} = 0A$ , AAM mode

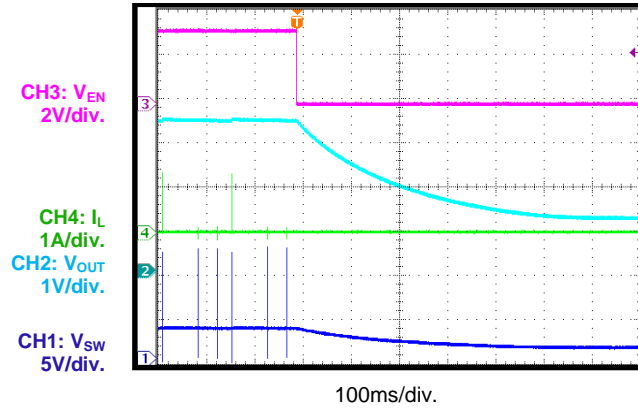
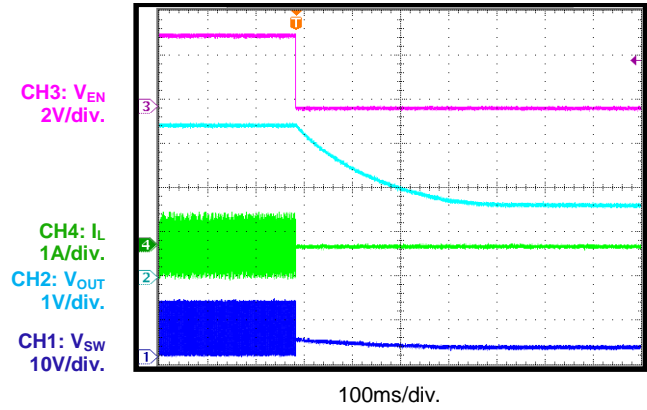
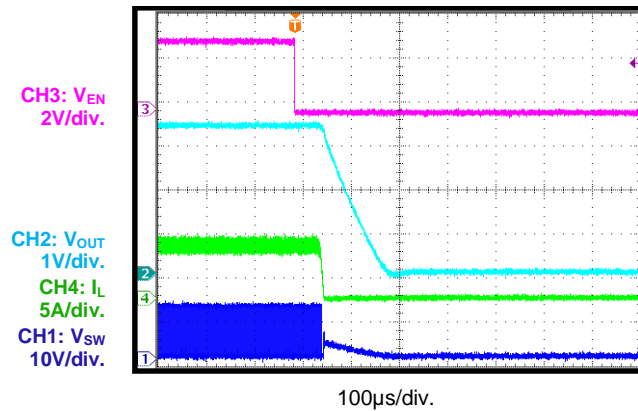
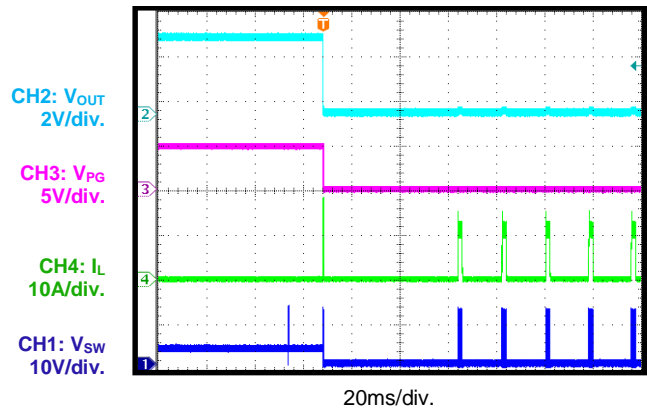
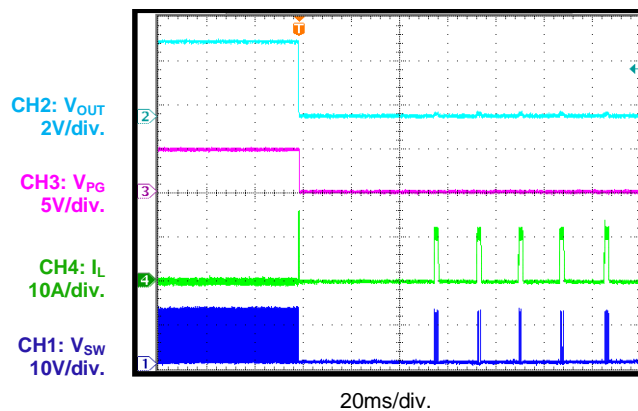
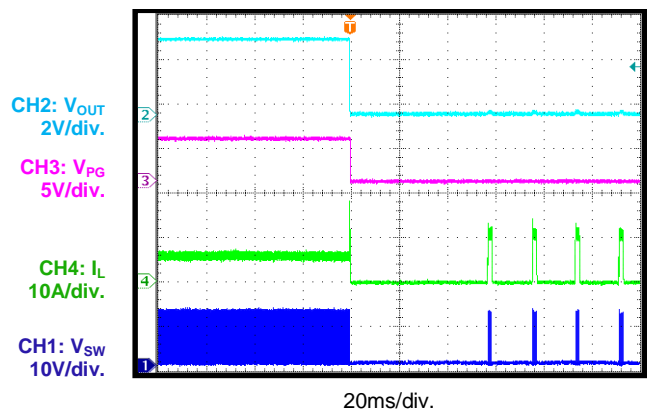
**Start-Up through VIN**
 $I_{OUT} = 0A$ , FCCM

**Start-Up through VIN**
 $I_{OUT} = 6A$ 

**TYPICAL PERFORMANCE CHARACTERISTICS (continued)**
 $V_{IN} = 12V$ ,  $V_{OUT} = 3.3V$ ,  $L = 4.7\mu H$ ,  $f_{sw} = 470kHz$ , AAM,  $T_A = 25^\circ C$ , unless otherwise noted.

**Shutdown through VIN**
 $I_{OUT} = 0A$ , AAM mode

**Shutdown through VIN**
 $I_{OUT} = 0A$ , FCCM

**Shutdown through VIN**
 $I_{OUT} = 6A$ 

**Start-Up through EN**
 $I_{OUT} = 0A$ , AAM mode

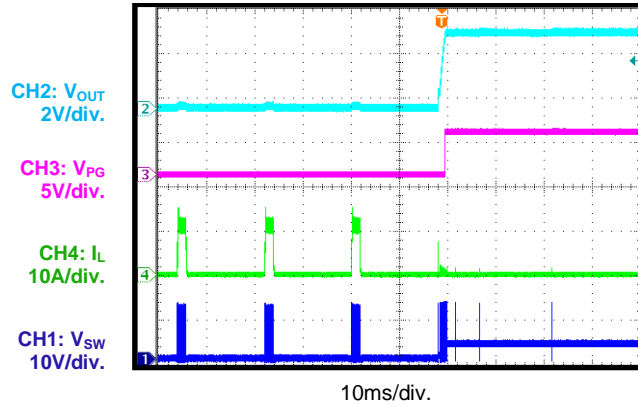
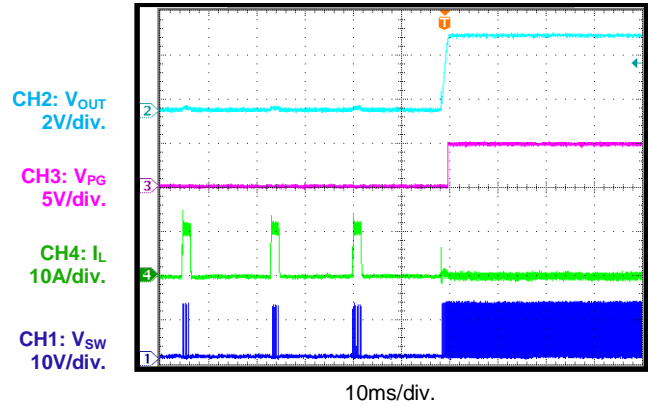
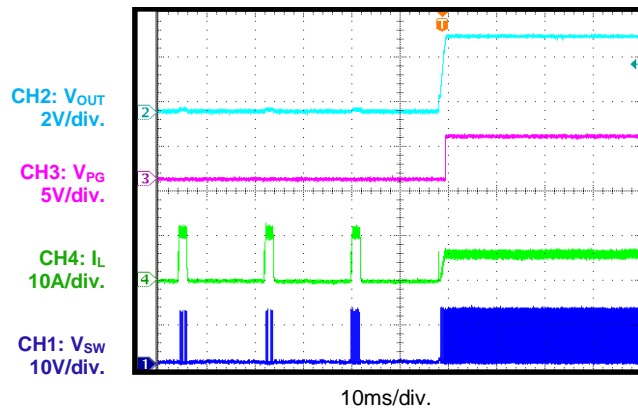
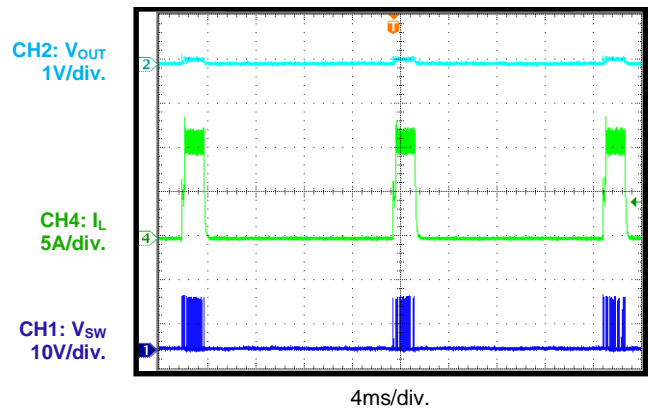
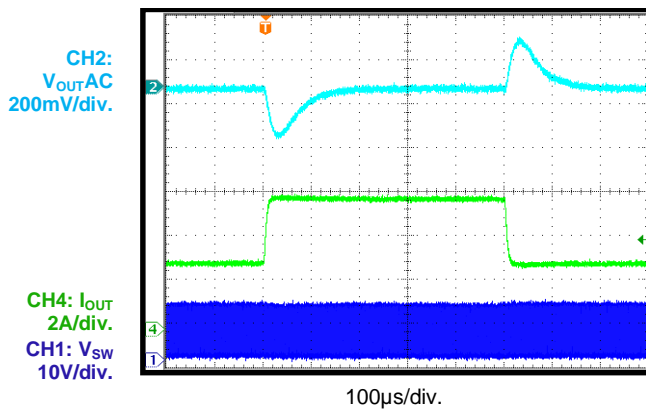
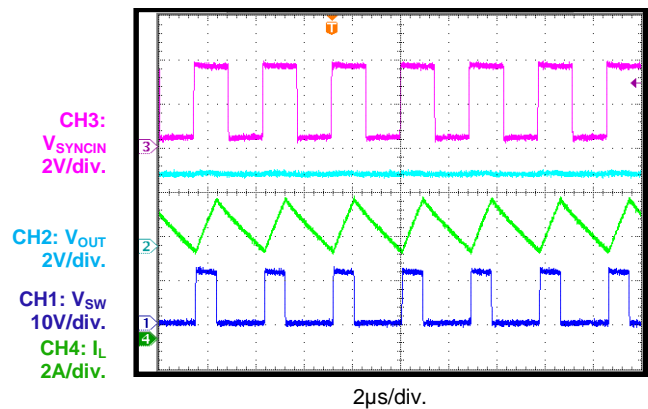
**Start-Up through EN**
 $I_{OUT} = 0A$ , FCCM

**Start-Up through EN**
 $I_{OUT} = 6A$ 

**TYPICAL PERFORMANCE CHARACTERISTICS (continued)**
 $V_{IN} = 12V$ ,  $V_{OUT} = 3.3V$ ,  $L = 4.7\mu H$ ,  $f_{sw} = 470kHz$ , AAM mode,  $T_A = 25^\circ C$ , unless otherwise noted.

**Shutdown through EN**
 $I_{OUT} = 0A$ , AAM mode

**Shutdown through EN**
 $I_{OUT} = 0A$ , FCCM

**Shutdown through EN**
 $I_{OUT} = 6A$ 

**SCP Entry**
 $I_{OUT} = 0A$ , AAM mode

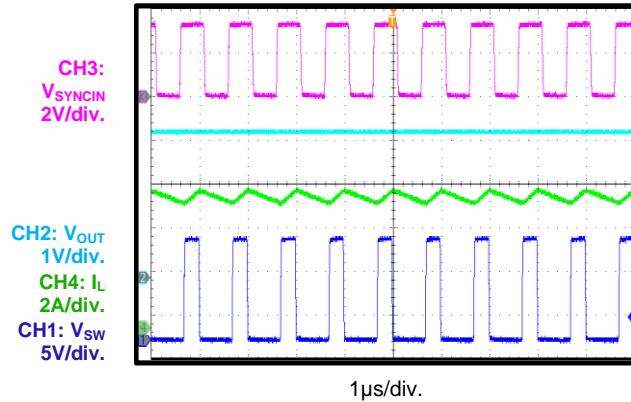
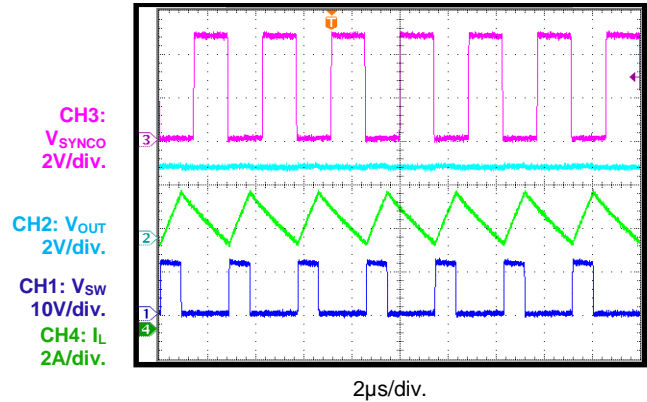
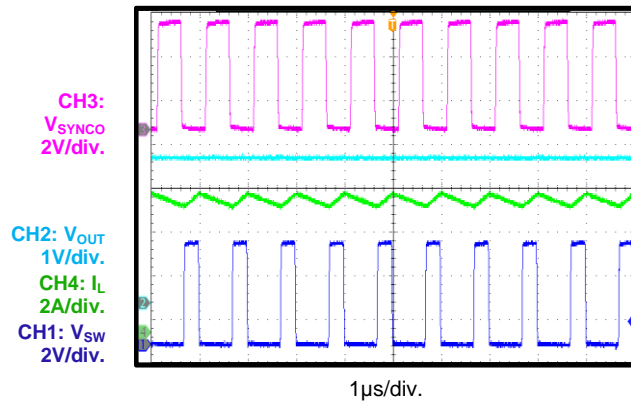
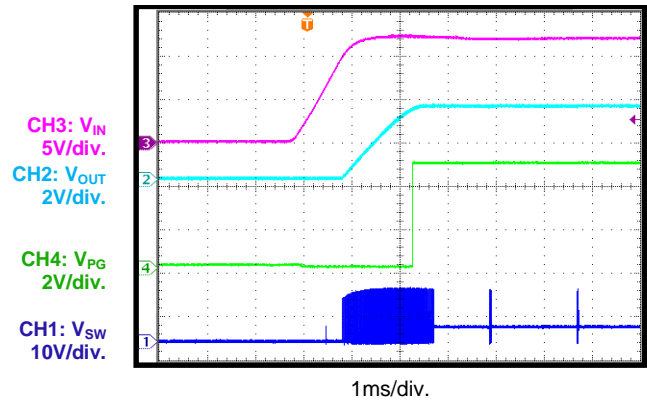
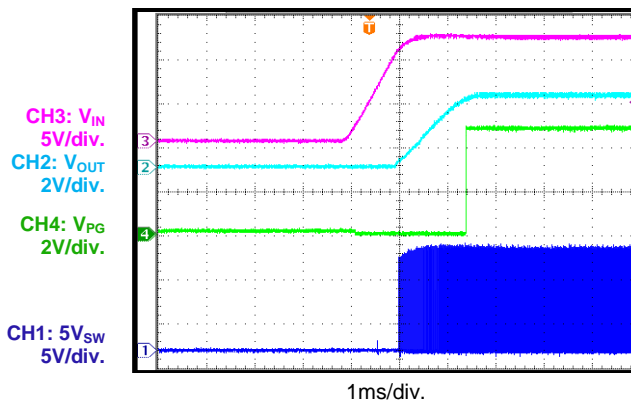
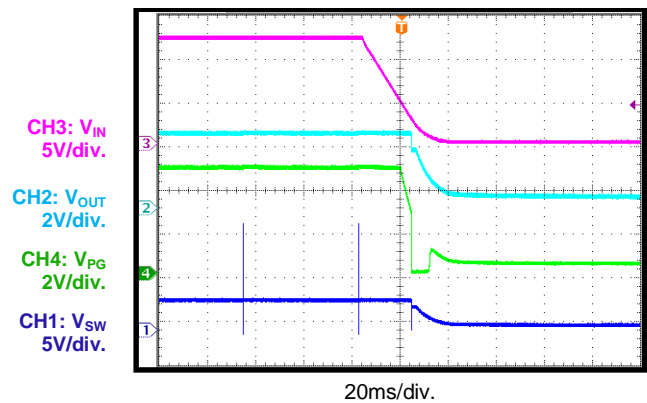
**SCP Entry**
 $I_{OUT} = 0A$ , FCCM

**SCP Entry**
 $I_{OUT} = 6A$ 

**TYPICAL PERFORMANCE CHARACTERISTICS (continued)**
 $V_{IN} = 12V$ ,  $V_{OUT} = 3.3V$ ,  $L = 4.7\mu H$ ,  $f_{sw} = 470kHz$ , AAM,  $T_A = 25^\circ C$ , unless otherwise noted.

**SCP Recovery**
 $I_{OUT} = 0A$ , AAM mode

**SCP Recovery**
 $I_{OUT} = 0A$ , FCCM

**SCP Recovery**
 $I_{OUT} = 6A$ 

**SCP Steady State**

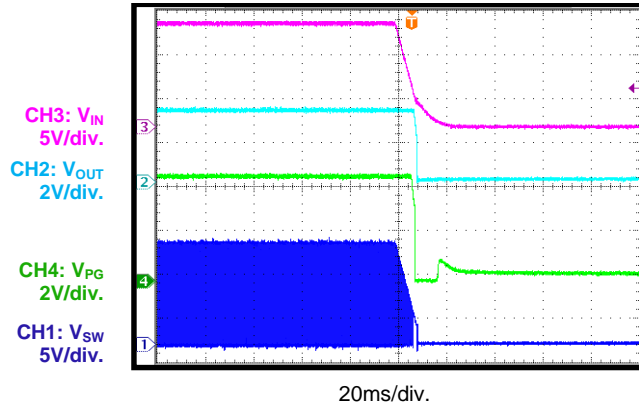
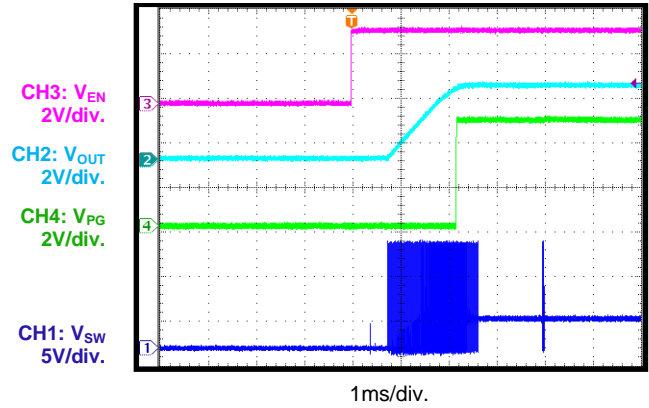
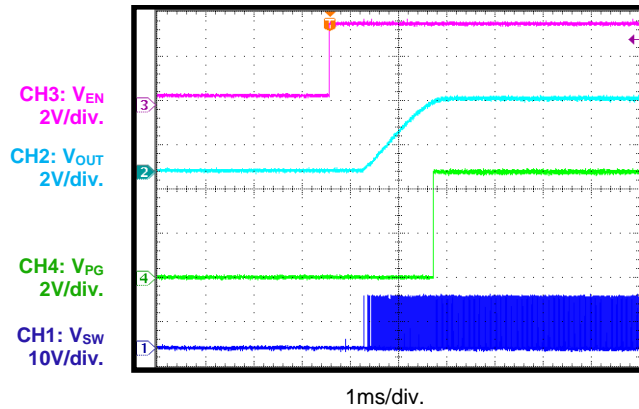
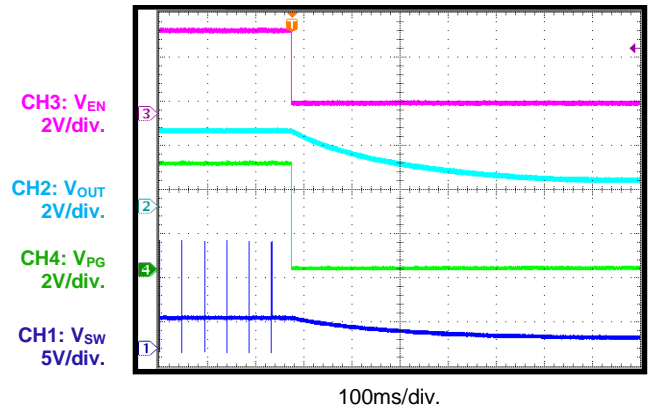
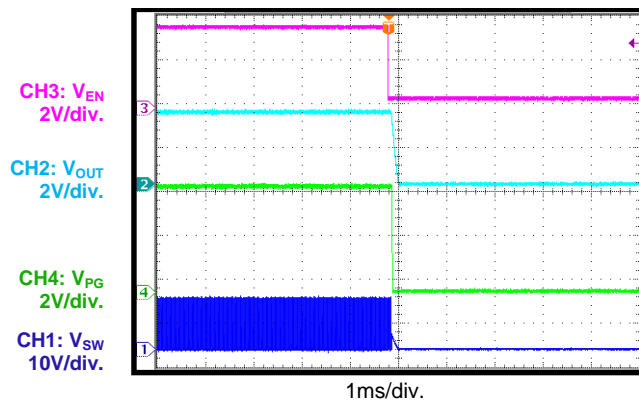
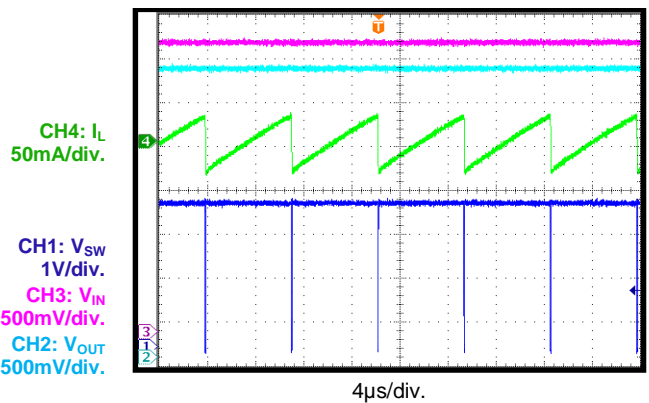
**Load Transient**
 $I_{OUT} = 3A$  to  $6A$ ,  $1.6A/\mu s$ 

**SYNCIN Operation**
 $I_{OUT} = 6A$ ,  $f_{SYNC} = 350kHz$ 

**TYPICAL PERFORMANCE CHARACTERISTICS (continued)**
 $V_{IN} = 12V$ ,  $V_{OUT} = 3.3V$ ,  $L = 4.7\mu H$ ,  $f_{sw} = 470kHz$ , AAM,  $T_A = 25^\circ C$ , unless otherwise noted.

**SYNCIN Operation**
 $I_{OUT} = 6A$ ,  $f_{SYNC} = 1000kHz$ 

**SYNCO Operation**
 $I_{OUT} = 6A$ ,  $f_{SYNC} = 350kHz$ 

**SYNCO Operation**
 $I_{OUT} = 6A$ ,  $f_{SYNC} = 1000kHz$ 

**PG Start-Up through VIN**
 $I_{OUT} = 0A$ 

**PG Start-Up through VIN**
 $I_{OUT} = 6A$ 

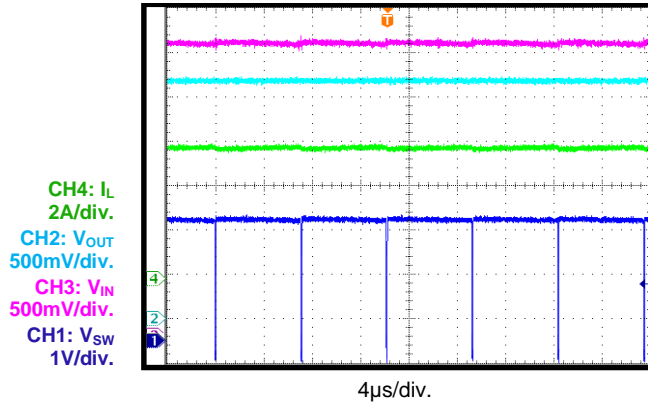
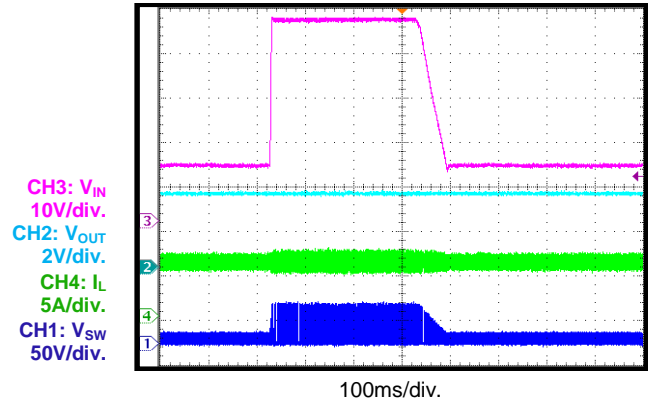
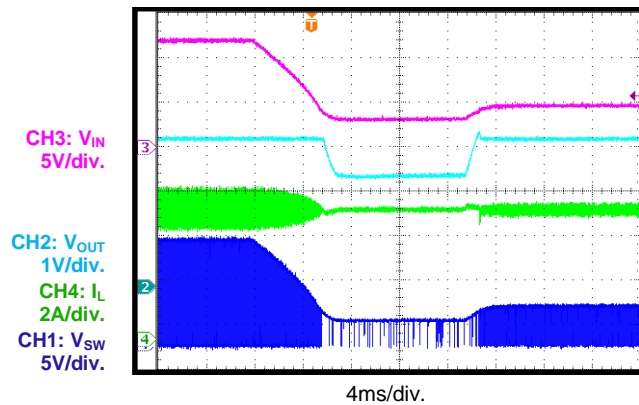
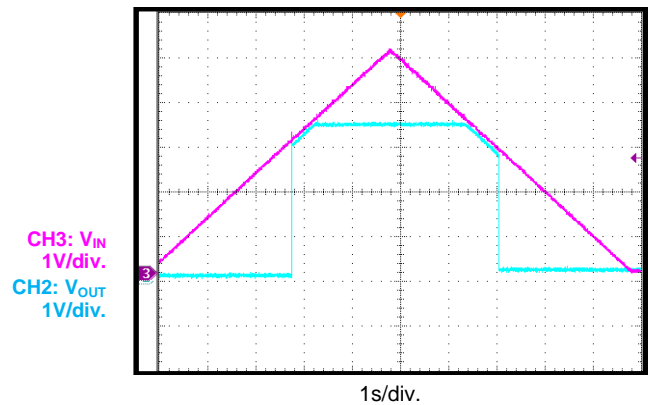
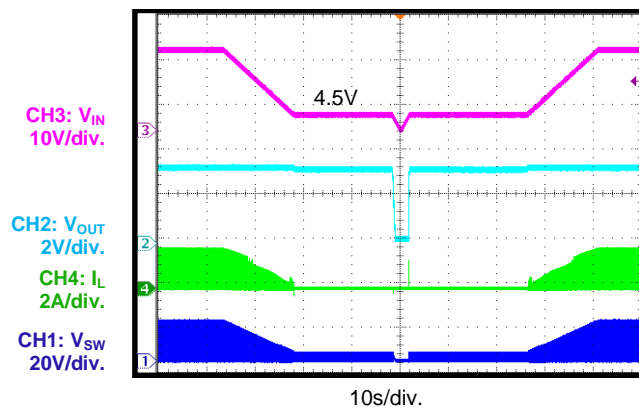
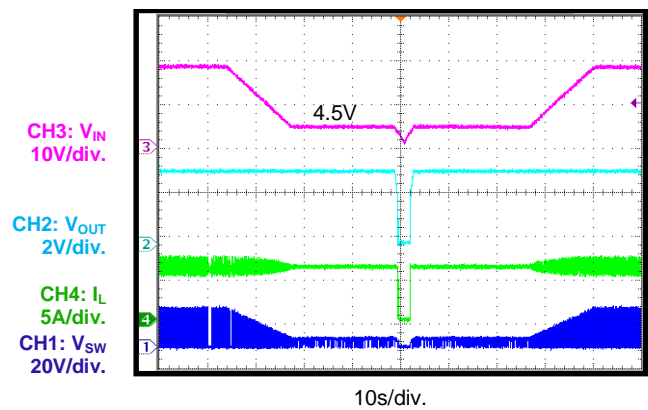
**PG Shutdown through VIN**
 $I_{OUT} = 0A$ 

**TYPICAL PERFORMANCE CHARACTERISTICS (continued)**
 $V_{IN} = 12V$ ,  $V_{OUT} = 3.3V$ ,  $L = 4.7\mu H$ ,  $f_{sw} = 470kHz$ , AAM mode,  $T_A = 25^\circ C$ , unless otherwise noted.

**PG Shutdown through VIN**
 $I_{OUT} = 6A$ 

**PG Start-Up through EN**
 $I_{OUT} = 0A$ 

**PG Start-Up through EN**
 $I_{OUT} = 6A$ 

**PG Shutdown through EN**
 $I_{OUT} = 0A$ 

**PG Shutdown through EN**
 $I_{OUT} = 6A$ 

**LDO Operation**
 $V_{IN} = 3.3V$ ,  $V_{OUT} = 3.3V$ ,  $I_{OUT} = 0A$ 



**TYPICAL PERFORMANCE CHARACTERISTICS (continued)**
 $V_{IN} = 12V$ ,  $V_{OUT} = 3.3V$ ,  $L = 4.7\mu H$ ,  $f_{sw} = 470kHz$ , AAM mode,  $T_A = 25^\circ C$ , unless otherwise noted.

**LDO Operation**
 $V_{IN} = 3.3V$ ,  $V_{OUT} = 3.3V$ ,  $I_{OUT} = 6A$ 

**Load Dump**
 $V_{IN} = 12V$  to  $36V$ ,  $I_{OUT} = 6A$ 

**Cold Crank**
 $V_{IN} = 12V$  to  $3.3V$  to  $5V$ ,  $I_{OUT} = 6A$ 

 **$V_{IN}$  Ramps Up and Down**
 $I_{OUT} = 0.1A$ 

 **$V_{IN}$  Ramps Down and Up**
 $I_{OUT} = 1mA$ 

 **$V_{IN}$  Ramps Down and Up**
 $I_{OUT} = 6A$ 



## FUNCTIONAL BLOCK DIAGRAM

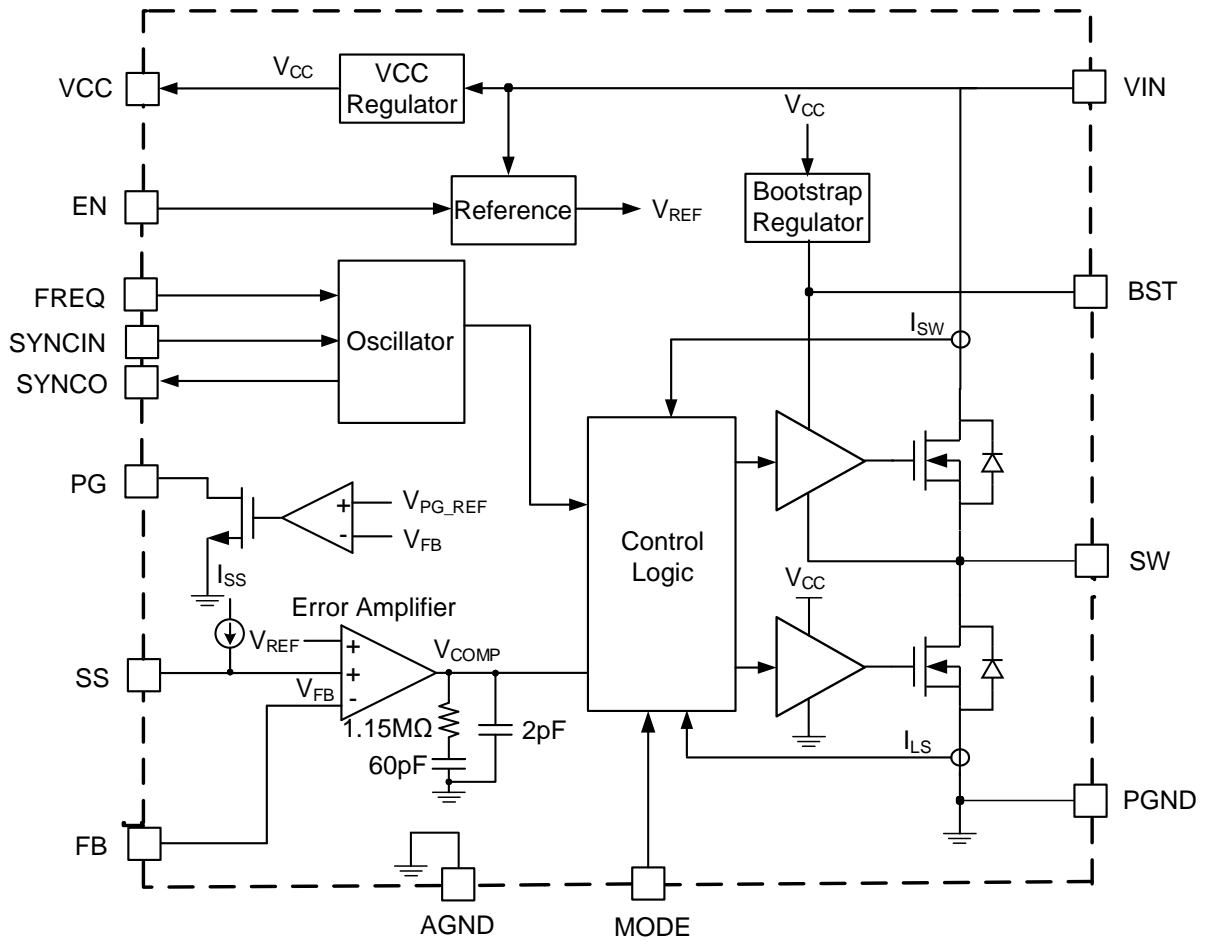

Figure 1: Functional Block Diagram

## TIMING SEQUENCE

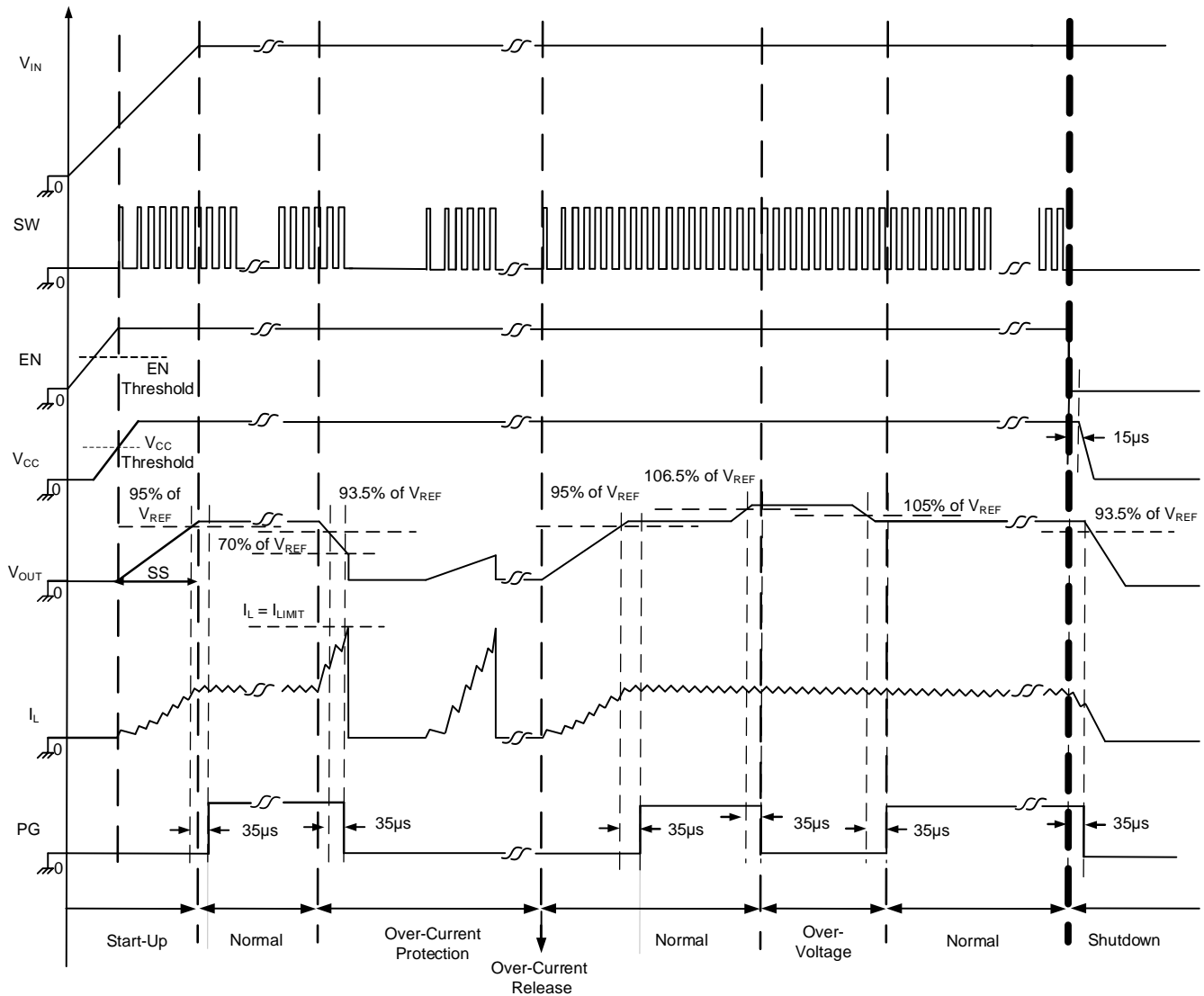

Figure 2: Timing Sequence

## OPERATION

The MP4316 is a synchronous, step-down switching converter with integrated internal power MOSFETs. It can achieve up to 6A of highly efficient, continuous output current ( $I_{OUT}$ ) with current control mode for fast loop response.

The device features a wide 3.3V to 45V input voltage ( $V_{IN}$ ) range, configurable switching frequency ( $f_{SW}$ ), external soft start (SS), and a precise current limit. Its low 1.7 $\mu$ A shutdown current ( $I_{SD}$ ) makes it well-suited for battery-powered applications.

### Pulse-Width Modulation (PWM) Control

At moderate to high output currents, the MP4316 operates with a fixed frequency in peak current control mode to regulate the output voltage ( $V_{OUT}$ ). A pulse-width modulation (PWM) cycle is initiated by the internal clock. At the rising edge of the clock, the high-side power MOSFET (HS-FET) turns on and remains on until its current reaches the value set by the internal comparator voltage ( $V_{COMP}$ ). The HS-FET remains on for a minimum of 100ns.

If the HS-FET is off, the low-side MOSFET (LS-FET) turns on and remains on until the next PWM cycle starts. The LS-FET remains on for a minimum of 80ns before the next cycle starts.

If the HS-FET current does not reach  $V_{COMP}$  within one PWM cycle, the HS-FET remains on to avoid shutting down the device. The HS-FET turns off after about 10 $\mu$ s, even if it has not reached  $V_{COMP}$ .

### Light-Load Operation

The MP4316 has a mode selection pin (MODE) that selects the IC's operation mode at light loads. Under light-load conditions, the MP4316 can operate in either forced continuous conduction mode (FCCM) or advanced asynchronous modulation (AAM) mode.

If MODE is pulled above 1.8V, then the MP4316 operates in FCCM. In FCCM, the device operates with a fixed frequency from no load to full loads. Advantages of FCCM include the controllable fixed frequency and lower  $V_{OUT}$  ripple under light-load conditions.

If MODE is pulled below 0.4V, then the MP4316 operates in AAM mode. AAM mode optimizes

efficiency under light-load and no-load conditions.

If AAM mode is enabled, then the MP4316 enters asynchronous operation as the inductor current ( $I_L$ ) approaches 0A (see Figure 3). If the load decreases further or if there is no load,  $V_{COMP}$  drops to its set value, and the device enters AAM mode.

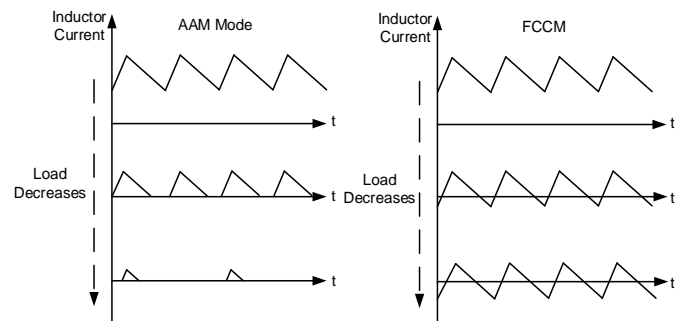

Figure 3: AAM and FCCM

In AAM mode, the internal clock resets once  $V_{COMP}$  reaches its set value. The crossover time is used as a benchmark for the next clock. If the load increases and  $V_{COMP}$  exceeds its set value, then the device operates in discontinuous conduction mode (DCM) or FCCM, which have a constant  $f_{SW}$ .

### Error Amplifier (EA)

The error amplifier (EA) compares the feedback (FB) voltage ( $V_{FB}$ ) to the internal reference voltage ( $V_{REF}$ ) (typically 0.815V), and outputs a current that is proportional to the difference between the voltages. This  $I_{OUT}$  charges the compensation network to set  $V_{COMP}$ , which controls the power MOSFET's current.

During normal operation, the minimum  $V_{COMP}$  is 0.9V, and the maximum is 2V. If the IC shuts down,  $V_{COMP}$  is pulled down to AGND internally.

### Internal Regulator (VCC)

The 4.9V internal regulator (VCC) powers most of the internal circuitry. The regulator uses the  $V_{IN}$  pin as its input and operates across the entire  $V_{IN}$  range. If  $V_{IN}$  exceeds 4.9V, then VCC is in full regulation. If  $V_{IN}$  drops below 4.9V, then VCC's output degrades.

### Bootstrap (BST) Charging

The internal bootstrap (BST) regulator charges

and regulates the BST capacitor ( $C_{BST}$ ) to about 5V. If the difference between the BST and SW pin voltages ( $V_{BST} - V_{SW}$ ) drops below 5V, then a P-channel MOSFET pass transistor connected between the VCC and BST pins turns on to charge  $C_{BST}$ . The external circuit should provide enough voltage headroom to facilitate the charging. If the HS-FET turns on,  $V_{BST}$  exceeds the VCC voltage ( $V_{CC}$ ), and  $C_{BST}$  cannot be charged.

During high duty cycles, there is less time to charge  $C_{BST}$ . This means that  $C_{BST}$  may not be charged sufficiently. If the external circuit has an insufficient voltage or not enough time to charge  $C_{BST}$ , an additional external circuit is required to ensure that  $V_{BST}$  remains in its normal operation range.

### Low-Dropout (LDO) Mode and Refreshing the Bootstrap Capacitor ( $C_{BST}$ )

To improve dropout, the MP4316 is designed to operate at almost 100% duty cycle when  $V_{BST} - V_{SW}$  exceeds 2.5V. If  $V_{BST} - V_{SW}$  drops below 2.5V, then under-voltage lockout (UVLO) turns off the HS-FET. This allows the LS-FET to conduct and refresh the charge on  $C_{BST}$ . In DCM or pulse-skip mode (PSM), the LS-FET turns on to refresh  $V_{BST}$ .

Since the supply current sourced from  $C_{BST}$  is low, the HS-FET can remain on for more than the required switching cycles to refresh  $C_{BST}$ . As a result, the converter has a high effective duty cycle.

The converter's effective duty cycle during dropout is determined by the voltage drops across the HS-FET, the LS-FET, the inductor resistance, the low-side diode, and the PCB resistance.

### Enable (EN) Control

Enable (EN) is a digital control pin that turns the converter on and off.

### Enabling the IC via an External High or Low Logic Signal

Pull EN below 0.85V to turn the converter off; pull EN above 1V to turn it on.

### Configurable $V_{IN}$ Under-Voltage Lockout (UVLO) Protection

If  $V_{IN}$  exceeds the UVLO rising threshold, then the IC can be enabled and disabled via the EN

pin. With an internal current source, a configurable  $V_{IN}$  UVLO threshold and hysteresis can be generated. The EN voltage ( $V_{EN}$ ) can be set via resistor dividers ( $R_{EN1} + R_{EN2}$ ) (see Figure 4).

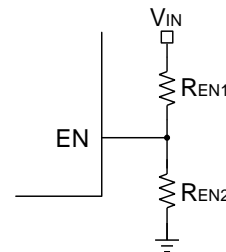

**Figure 4: Enable Divider Circuit**

### Configurable Switching Frequency ( $f_{SW}$ ) and Frequency Foldback

The MP4316's  $f_{SW}$  can be configured via an external resistor ( $R_{FREQ}$ ) connected from the FREQ pin to AGND, or by a logic-level SYNC signal.

See the  $f_{SW}$  vs.  $R_{FREQ}$  curves on page 15 to select  $R_{FREQ}$  and set  $f_{SW}$ . If  $f_{SW}$  is set high, it may fold back at high input voltages to avoid triggering a minimum on time ( $t_{ON\_MIN}$ ) that would force the output out of regulation.

Set the  $f_{SW}$  between 350kHz and 1000kHz for car battery applications. Table 1 lists the recommended  $R_{FREQ}$  values for common switching frequencies. High frequencies can be used in applications that do not require a critical  $f_{SW}$  limit or that have a low, stable  $V_{IN}$ .

**Table 1:  $R_{FREQ}$  vs.  $f_{SW}$**

$R_{FREQ}$ (k $\Omega$ )	$f_{SW}$ (kHz)
86.6	350
80.6	380
75	410
62	470
59	500
54.9	530
49.9	590
45.3	640
41.2	700
37.4	760
34	830
30.9	910
28.7	960
26.1	1000

### Frequency Spread Spectrum (FSS)

The MP4316 employs a 12kHz modulation frequency and a fixed 128-step triangular profile to spread the internal  $f_{SW}$  across a 20% ( $\pm 10\%$ ) window (see Figure 5). The steps are fixed and independent of the set  $f_{SW}$ . This optimizes the frequency spread spectrum (FSS) performance.

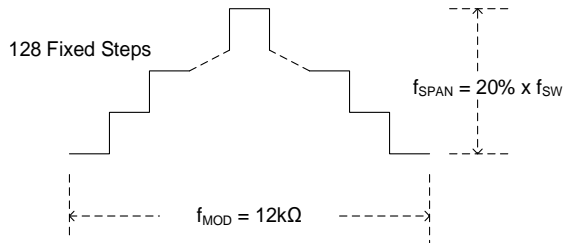

**Figure 5: Frequency Spread Spectrum**

Side bands are created by modulating  $f_{SW}$  via the triangle modulation waveform. This reduces the fundamental  $f_{SW}$  emission power and harmonics, which reduces noise caused by peak electromagnetic interference (EMI).

### Soft Start (SS)

The MP4316 employs SS to prevent  $V_{OUT}$  from overshooting during start-up.

Once a SS is initiated, an internal current source charges the external soft-start capacitor ( $C_{SS}$ ). If the soft-start voltage ( $V_{SS}$ ) drops below  $V_{REF}$ , then  $V_{SS}$  overrides  $V_{REF}$  and the EA uses  $V_{SS}$  as the reference. If  $V_{SS}$  exceeds  $V_{REF}$ , then the EA uses  $V_{REF}$  as the reference.

The soft-start capacitance ( $C_{SS}$ ) can be calculated with Equation (1):

$$C_{SS}(\text{nF}) = \frac{t_{SS}(\text{ms}) \times I_{SS}(\mu\text{A})}{V_{REF}(\text{V})} = 13.5 \times t_{SS}(\text{ms}) \quad (1)$$

The SS pin can be used for tracking and sequencing.

### Pre-Biased Start-Up

If  $V_{FB}$  exceeds  $V_{SS} - 150\text{mV}$  during start-up, then the output has a pre-biased voltage. With a pre-biased voltage, the HS-FET and LS-FET do not turn on until  $V_{SS}$  exceeds  $V_{FB}$ .

### Thermal Shutdown

Thermal shutdown prevents the IC from operating at exceedingly high temperatures. If the die temperature exceeds the thermal shutdown threshold (about  $170^\circ\text{C}$ ), then the device shuts down. Once the temperature drops

below about  $150^\circ\text{C}$ , the device initiates a SS and resumes normal operation.

### Current Comparator and Current Limit

The MOSFET currents are sensed via a current-sense MOSFET. This current is fed to the high-speed current comparator for current mode control. The current comparator uses this sensed current as one of its inputs.

If the HS-FET turns on, the comparator is blanked until the end of the turn-on period to mitigate noise. The comparator compares the MOSFET current to the set  $V_{COMP}$  value. If the sensed current exceeds  $V_{COMP}$ , the comparator outputs low to turn off the HS-FET. The internal MOSFET maximum current is limited internally cycle by cycle.

### Output Over-Voltage Protection (OVP) with Hiccup Mode

If an output short to ground occurs,  $V_{OUT}$  may drop below 70% of its nominal output voltage. If this occurs, the MP4316 shuts down to discharge  $C_{SS}$ . Once  $C_{SS}$  is discharged, the device initiates a SS to resume normal operation. This process is repeated until the fault condition is removed.

### Start-Up and Shutdown

If both  $V_{IN}$  and  $V_{EN}$  exceed their respective thresholds, the MP4316 starts up. The reference block starts up first to generate a stable  $V_{REF}$  and currents. Then the internal regulator starts up to provide a stable supply for the remaining circuitries.

While the internal supply rail is up, an internal timer turns the HS-FET and LS-FET off for about  $50\mu\text{s}$  to blank any start-up glitches. Once the soft-start block is enabled, the device outputs low to ensure that the remaining circuitry is ready before slowly ramping up.

Three events can shut down the IC:  $V_{EN}$  going low,  $V_{IN}$  going low, and thermal shutdown. Once shutdown is initiated, the signaling path is blocked to avoid triggering any faults. Then  $V_{COMP}$  and the internal supply rail are pulled down. The floating driver is not subject to this shutdown command, but its charging path is disabled.

### Power Good (PG) Output

The power good (PG) pin is an open-drain output. If using the PG pin, connect it to a power source via a pull-up resistor. If  $V_{OUT}$  is between 95% and 105% of the nominal voltage, PG is pulled high. If  $V_{OUT}$  exceeds 106.5% or drops below 93.5% of the nominal voltage, PG is pulled low.

### SYNCIN and SYNCO

$f_{SW}$  can be synchronized to the rising edge of the SYNCIN clock. It is recommended that the SYNCIN frequency ( $f_{SYNCIN}$ ) be between 350kHz and 1000kHz. SYNCIN's off time ( $t_{OFF}$ ) should be shorter than the internal oscillator period; otherwise, the internal clock may turn on the HS-FET before the rising edge of SYNCIN.

There is no SYNCIN pulse width limit; however,

there is always parasitic capacitance on the pad. If the pulse width is too short, then a clear rising and falling edge may not be achieved due to the parasitic capacitance. It is recommended to set the pulse width above 100ns.

If using SYNCIN in AAM mode, pull SYNCIN below 0.4V or float SYNCIN before start-up. Then add the external SYNCIN clock. Connect a 10k $\Omega$  to 51k $\Omega$  resistor between SYNCIN and AGND to avoid floating SYNCIN.

The SYNCO pin provides a default 180° phase-shifted clock for the internal oscillator. If there is no external SYNCIN clock, SYNCO can provide a 180° phase-shifted clock that is compared to the internal clock.



## APPLICATION INFORMATION

### Setting the Output Voltage

The external resistor divider connected to the FB pin sets  $V_{OUT}$  (see Figure 6).

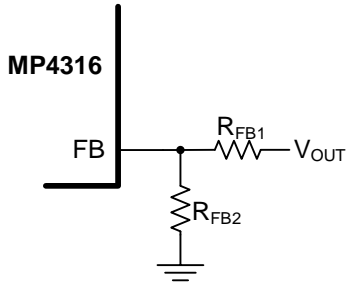

**Figure 6: Feedback Network**

The feedback resistor ( $R_{FB2}$ ) can be calculated with Equation (2):

$$R_{FB2} = \frac{R_{FB1}}{\frac{V_{OUT}}{0.815V} - 1} \quad (2)$$

Table 2 lists the recommended feedback resistor values for common output voltages.

**Table 2: Recommended Resistor Values for Common Output Voltages**

$V_{OUT}$ (V)	$R_{FB1}$ (k $\Omega$ )	$R_{FB2}$ (k $\Omega$ )
3.3	100 (1%)	32.4 (1%)
5	100 (1%)	19.6 (1%)

### Selecting the Input Capacitor ( $C_{IN}$ )

The step-down converter has a discontinuous input current, and requires a capacitor to supply AC current to the converter while maintaining the DC  $V_{IN}$ . For the best performance, use low-ESR capacitors. Ceramic capacitors with X5R or X7R dielectrics are highly recommended due to their low ESR and small temperature coefficients.

For most applications, a 4.7 $\mu$ F to 10 $\mu$ F capacitor is sufficient. It is strongly recommended to use another low-value capacitor (0.1 $\mu$ F) with a small package size (0603) to absorb high-frequency noise. Place the smaller capacitor as close to the  $V_{IN}$  pin and PGND as possible.

Since the input capacitor ( $C_{IN}$ ) absorbs the input switching current, it requires an adequate ripple current rating. The RMS current in  $C_{IN}$  ( $I_{CIN}$ ) can be estimated with Equation (3):

$$I_{CIN} = I_{LOAD} \times \sqrt{\frac{V_{OUT}}{V_{IN}} \times \left(1 - \frac{V_{OUT}}{V_{IN}}\right)} \quad (3)$$

The worst-case condition occurs at  $V_{IN} = 2 \times V_{OUT}$ , which can be calculated with Equation (4):

$$I_{CIN} = \frac{I_{LOAD}}{2} \quad (4)$$

For simplification, choose a  $C_{IN}$  with an RMS current rating greater than half of the maximum load current ( $I_{LOAD\_MAX}$ ).

$C_{IN}$  can be electrolytic, tantalum, or ceramic. If using electrolytic or tantalum capacitors, place a small, high-quality ceramic capacitor (0.1 $\mu$ F) as close to the device as possible.

The input capacitance determines the input voltage ripple of the converter. If using ceramic capacitors, ensure that  $C_{IN}$  meets the system design's input voltage ripple ( $\Delta V_{IN}$ ) requirement.  $C_{IN}$  should have enough capacitance to provide a sufficient charge to prevent an excessive voltage ripple at the input. The input voltage ripple ( $\Delta V_{IN}$ ) caused by the capacitance can be estimated with Equation (5):

$$\Delta V_{IN} = \frac{I_{LOAD}}{f_{SW} \times C_{IN}} \times \frac{V_{OUT}}{V_{IN}} \times \left(1 - \frac{V_{OUT}}{V_{IN}}\right) \quad (5)$$

### Selecting the Output Capacitor ( $C_{OUT}$ )

The output capacitor ( $C_{OUT}$ ) maintains the DC  $V_{OUT}$ . Use ceramic, tantalum, or low-ESR electrolytic capacitors. Ceramic capacitors with low ESR are recommended for their small size and low output voltage ripple. The output voltage ripple ( $\Delta V_{OUT}$ ) can be calculated with Equation (6):

$$\Delta V_{OUT} = \frac{V_{OUT}}{f_{SW} \times L} \times \left(1 - \frac{V_{OUT}}{V_{IN}}\right) \times \left(R_{ESR} + \frac{1}{8 \times f_{SW} \times C_{OUT}}\right) \quad (6)$$

Where  $L$  is the inductance, and  $R_{ESR}$  is the equivalent series resistance of  $C_{OUT}$ .

For ceramic capacitors, the capacitance dominates the impedance at  $f_{SW}$  and causes the majority of  $\Delta V_{OUT}$ . For simplification,  $\Delta V_{OUT}$  can be estimated with Equation (7):

$$\Delta V_{OUT} = \frac{V_{OUT}}{8 \times f_{SW}^2 \times L \times C_{OUT}} \times \left(1 - \frac{V_{OUT}}{V_{IN}}\right) \quad (7)$$

For tantalum or electrolytic capacitors, the ESR dominates the impedance at  $f_{SW}$ .

For simplification,  $\Delta V_{OUT}$  can be calculated with Equation (8):

$$\Delta V_{OUT} = \frac{V_{OUT}}{f_{SW} \times L} \times \left(1 - \frac{V_{OUT}}{V_{IN}}\right) \times R_{ESR} \quad (8)$$

The characteristics of  $C_{OUT}$  also affect the stability of the regulation system. The MP4316 can be optimized for a wide range of capacitances and ESR values.

### Selecting the Inductor

For most applications, a 1 $\mu$ H to 10 $\mu$ H inductor with a DC current rating of at least 25% greater than  $I_{LOAD\_MAX}$  is recommended. For higher efficiency, choose an inductor with a lower DC resistance. A larger-value inductor offers less ripple current and a lower  $\Delta V_{OUT}$ ; however, a larger-value inductor also has a larger physical size, higher series resistance, and lower saturation current. A good rule to determine the inductance is to allow the inductor ripple current ( $\Delta I_L$ ) to be approximately 30% of  $I_{LOAD\_MAX}$ . The inductance can be estimated with Equation (9):

$$L = \frac{V_{OUT}}{f_{SW} \times \Delta I_L} \times \left(1 - \frac{V_{OUT}}{V_{IN}}\right) \quad (9)$$

Choose  $\Delta I_L$  to be about 30% of  $I_{LOAD\_MAX}$ . The maximum inductor peak current ( $I_{LP}$ ) can be calculated with Equation (10):

$$I_{LP} = I_{LOAD} + \frac{V_{OUT}}{2 \times f_{SW} \times L} \times \left(1 - \frac{V_{OUT}}{V_{IN}}\right) \quad (10)$$

### Setting $V_{IN}$ Under-Voltage Lockout (UVLO)

The MP4316 has an internal, fixed UVLO threshold. The rising threshold is 3V, and the falling threshold is about 2.7V. For applications that require a higher UVLO, place an external resistor divider between the  $V_{IN}$  and EN pins to raise the UVLO threshold (see Figure 7).

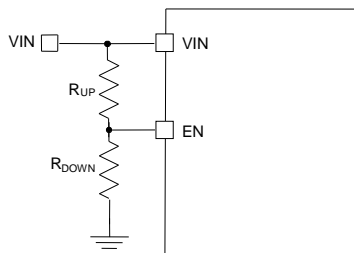

**Figure 7: Setting the UVLO Threshold via the EN Resistor Divider**

The UVLO rising threshold ( $V_{IN\_UVLO\_RISING}$ ) can be calculated with Equation (11):

$$V_{IN\_UVLO\_RISING} = \left(1 + \frac{R_{UP}}{R_{DOWN}}\right) \times V_{EN\_RISING} \quad (11)$$

Where  $V_{EN\_RISING}$  is 1V.

The UVLO falling threshold ( $V_{IN\_UVLO\_FALLING}$ ) can be calculated with Equation (12):

$$V_{IN\_UVLO\_FALLING} = \left(1 + \frac{R_{UP}}{R_{DOWN}}\right) \times V_{EN\_FALLING} \quad (12)$$

Where  $V_{EN\_FALLING}$  is 0.85V.

### Selecting the External Bootstrap (BST) Diode and Resistor

An external BST diode can enhance the BST regulator's efficiency during high duty cycles. A 2.5V to 5V power supply can be used to power the external BST diode. It is recommended to use  $V_{CC}$  or  $V_{OUT}$  as the power supply (see Figure 8).

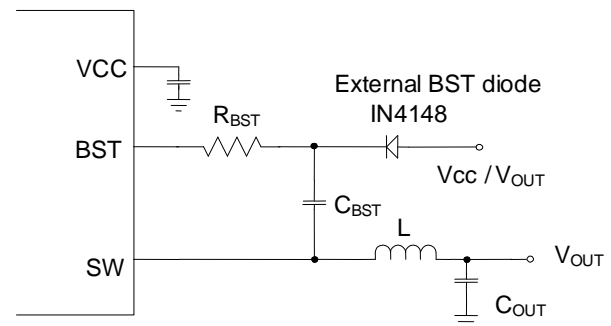

**Figure 8: Optional External BST Diode for Enhanced Efficiency**

It is recommended to use an IN4148 external BST diode. 1 $\mu$ F. A resistor ( $R_{BST}$ ) in series with  $C_{BST}$  can reduce  $V_{SW}$  rising slew rate and voltage spikes. This improves EMI performance and reduces voltage stress at a high  $V_{IN}$ . A higher resistance is better for SW spike reduction, but can compromise efficiency. To make a tradeoff between EMI and efficiency, it is recommended to keep  $R_{BST}$  below 20 $\Omega$ . The recommended  $C_{BST}$  value is 0.1 $\mu$ F to 1 $\mu$ F.

### Selecting the VCC Capacitor ( $C_{VCC}$ )

The VCC capacitor ( $C_{VCC}$ ) should have a capacitance of 10 times the boost capacitor's capacitance.  $C_{VCC}$  should not exceed 68 $\mu$ F.



**PCB Layout Guidelines** <sup>(10)</sup>

Efficient PCB layout is critical for stable operation. It is recommended to use a 4-layer layout to improve thermal performance. For the best results, refer to Figure 9 and follow the guidelines below:

1. Place the symmetric input capacitors as close to VIN and PGND as possible.
2. Connect a large copper plane directly to PGND.
3. If the bottom PCB layer is the ground plane, place multiple vias near PGND.
4. Use short, direct, and wide traces for the high-current paths connected to VIN and PGND.
5. Place  $C_{IN}$  as close to the VIN and PGND pins as possible to minimize high-frequency noise. It is recommended that  $C_{IN}$  be a ceramic bypass capacitor in a small 0603 package.
6. Keep the connection between  $C_{IN}$  and VIN as short and wide as possible.
7. Place  $C_{VCC}$  as close to VCC and AGND as possible.
8. Route the SW and BST traces away from sensitive analog areas, such as FB.
9. Keep the FB trace as short as wide as possible by placing the FB resistors close to the IC.
10. Use multiple vias to connect the power planes and the internal layers.

**Note:**

10) The recommended PCB layout is based on Figure 10 on page 34.

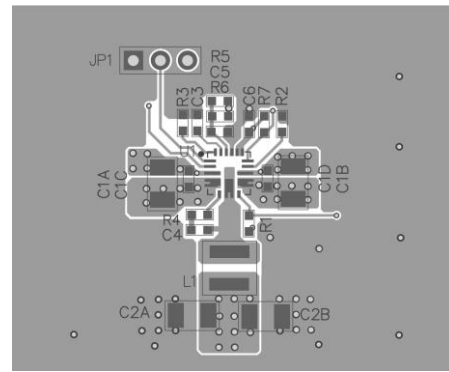
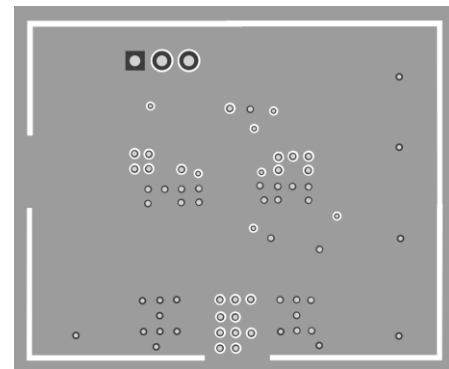
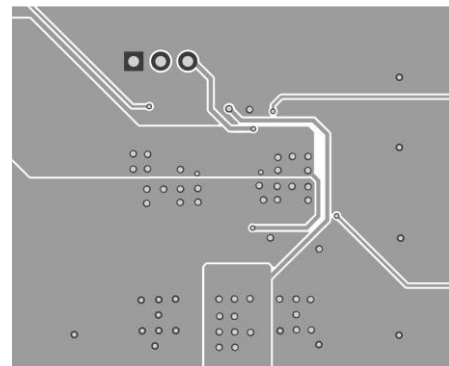
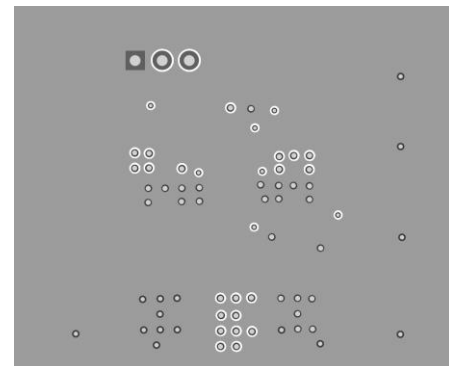

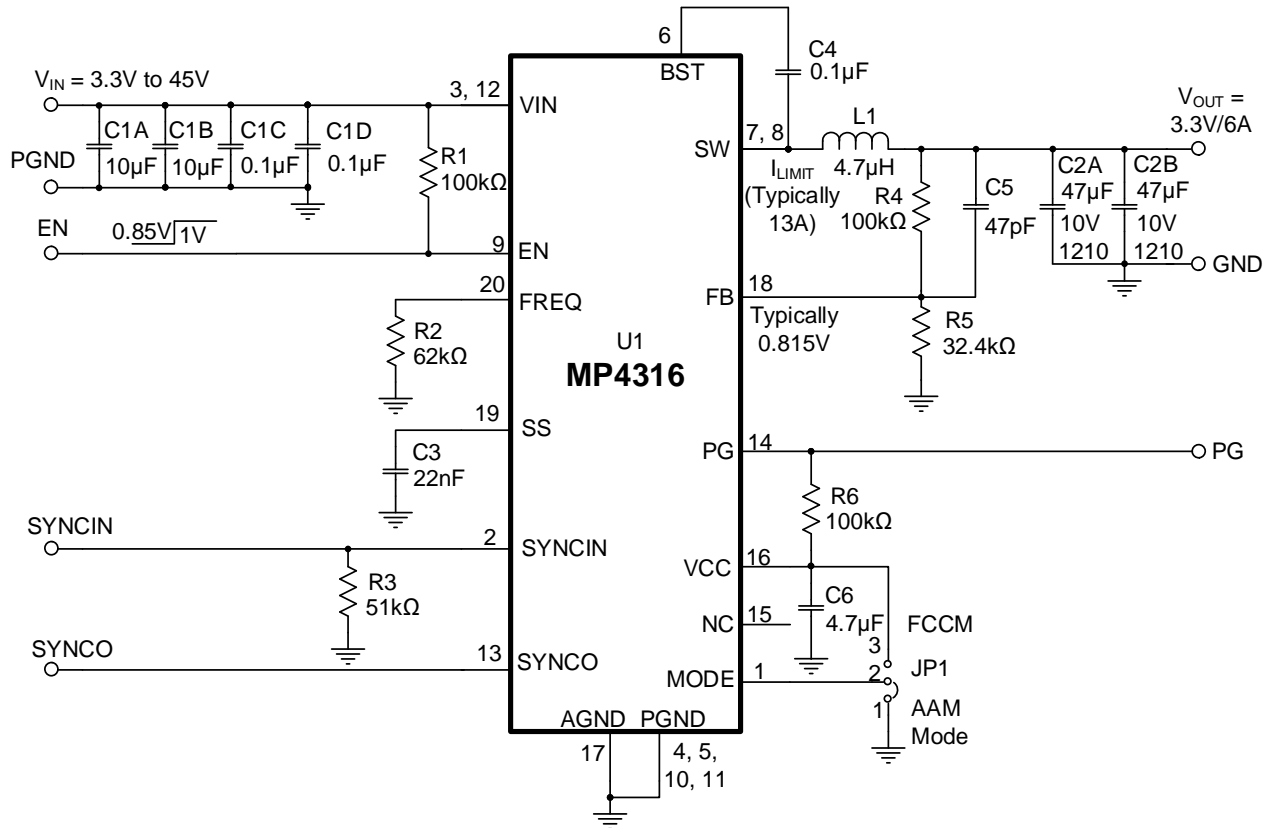
**Top Layer**

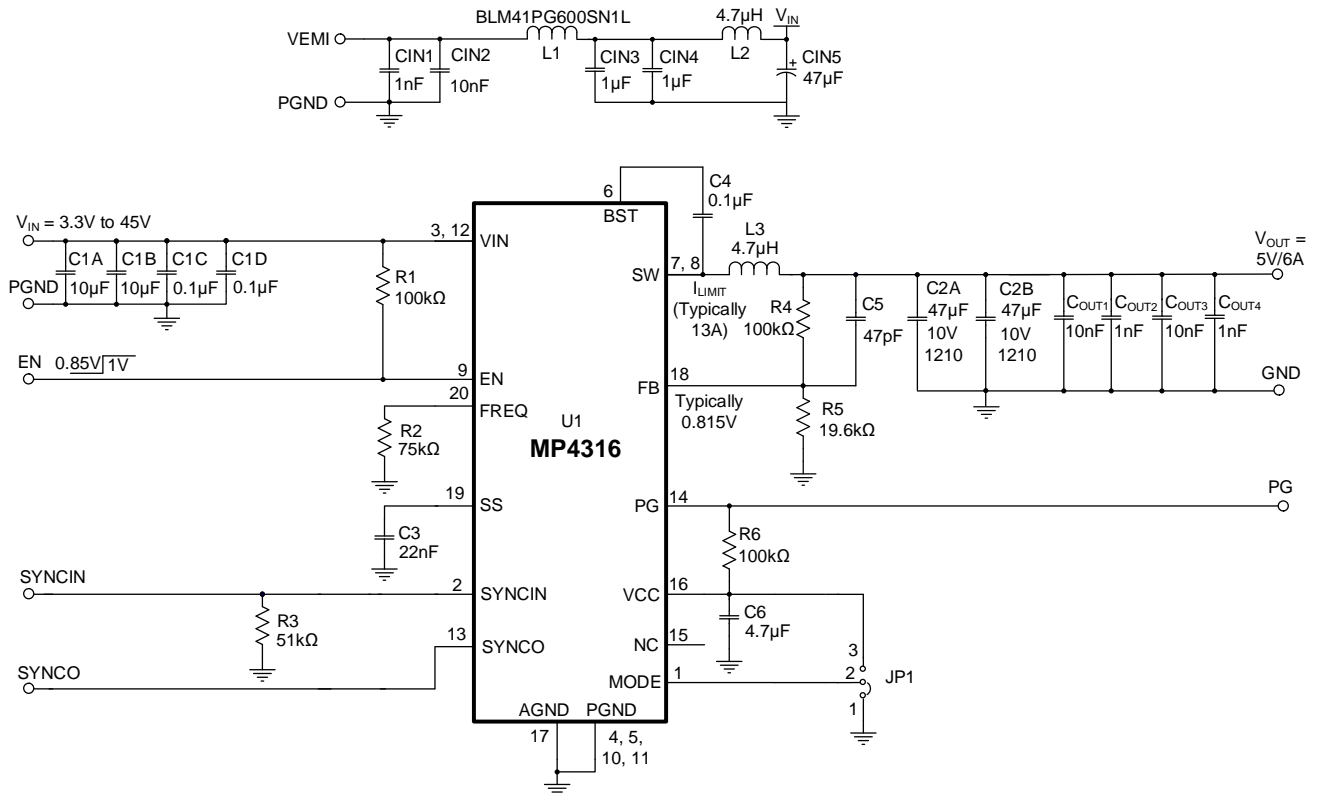
**Mid-Layer 1**

**Mid-Layer 2**

**Bottom Layer**
**Figure 9: Recommended PCB Layout**

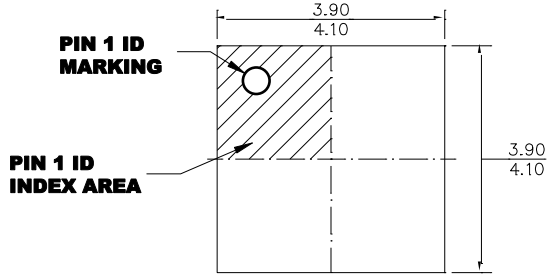
**TYPICAL APPLICATION CIRCUITS**

**Figure 10: Typical Application Circuit ( $V_{OUT} = 3.3V$ ,  $f_{SW} = 470kHz$ )**

**TYPICAL APPLICATION CIRCUITS (continued)**

**Figure 11: Typical Application Circuit ( $V_{OUT} = 5V$ ,  $f_{sw} = 410kHz$ , with EMI Filters)**

# PACKAGE INFORMATION

## QFN-20 (4mmx4mm) Wettable Flank

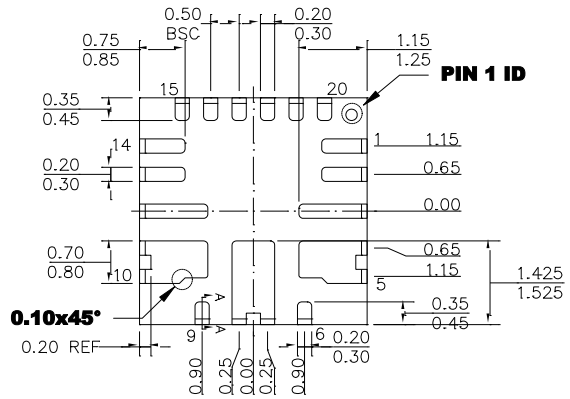

**TOP VIEW**



**BOTTOM VIEW**

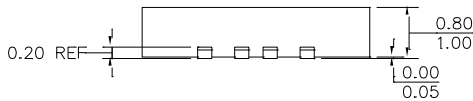

**SIDE VIEW**

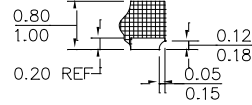

**SECTION A-A**

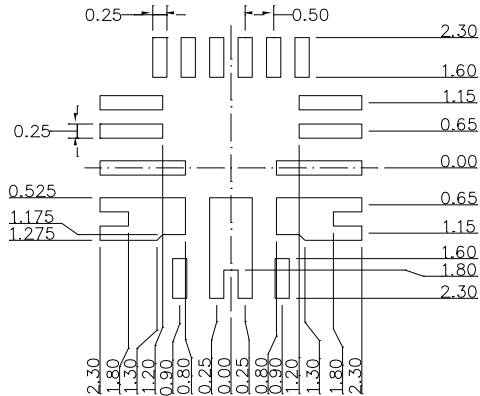

**RECOMMENDED LAND PATTERN**

**NOTE:**

- 1) THE LEAD SIDE IS WETTABLE.
- 2) ALL DIMENSIONS ARE IN MILLIMETERS.
- 3) LEAD COPLANARITY SHALL BE 0.08 MILLIMETERS MAX.
- 4) JEDEC REFERENCE IS MO-220.
- 5) DRAWING IS NOT TO SCALE.

### CARRIER INFORMATION

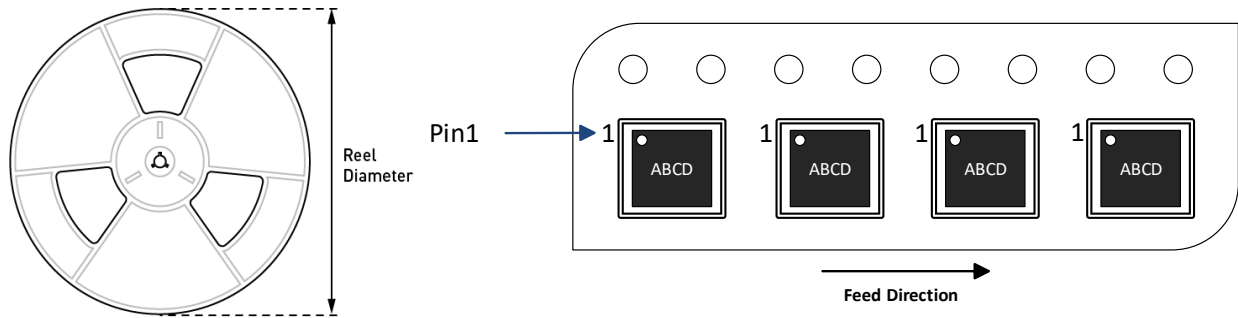

Part Number	Package Description	Quantity/ Reel	Quantity/ Tube <sup>(13)</sup>	Reel Diameter	Carrier Tape Width	Carrier Tape Pitch
MP4316GRE-Z	QFN-20 (4mmx4mm)	5000	N/A	13in	12mm	8mm

**Note:**

11) N/A means “not applicable.” Contact MPS for 500 pieces of tape and reel prototype quantities. The order code for a 500-piece partial reel is “-P”. The tape and reel dimensions are the same as the full reel.

## REVISION HISTORY

Revision #	Revision Date	Description	Pages Updated
1.0	9/22/2021	Initial Release	-

**Notice:** The information in this document is subject to change without notice. Please contact MPS for current specifications. Users should warrant and guarantee that third-party Intellectual Property rights are not infringed upon when integrating MPS products into any application. MPS will not assume any legal responsibility for any said applications.