

ALISE-70-W

~36° wide beam

SPECIFICATION:

Dimensions	Ø 70.0 mm
Height	42 mm
ROHS compliant	yes ⓘ

MATERIALS:

Component	Type	Material	Colour	Finish	Coating
ALISE-70-W	Reflector	Aluminium	metal		Anodized







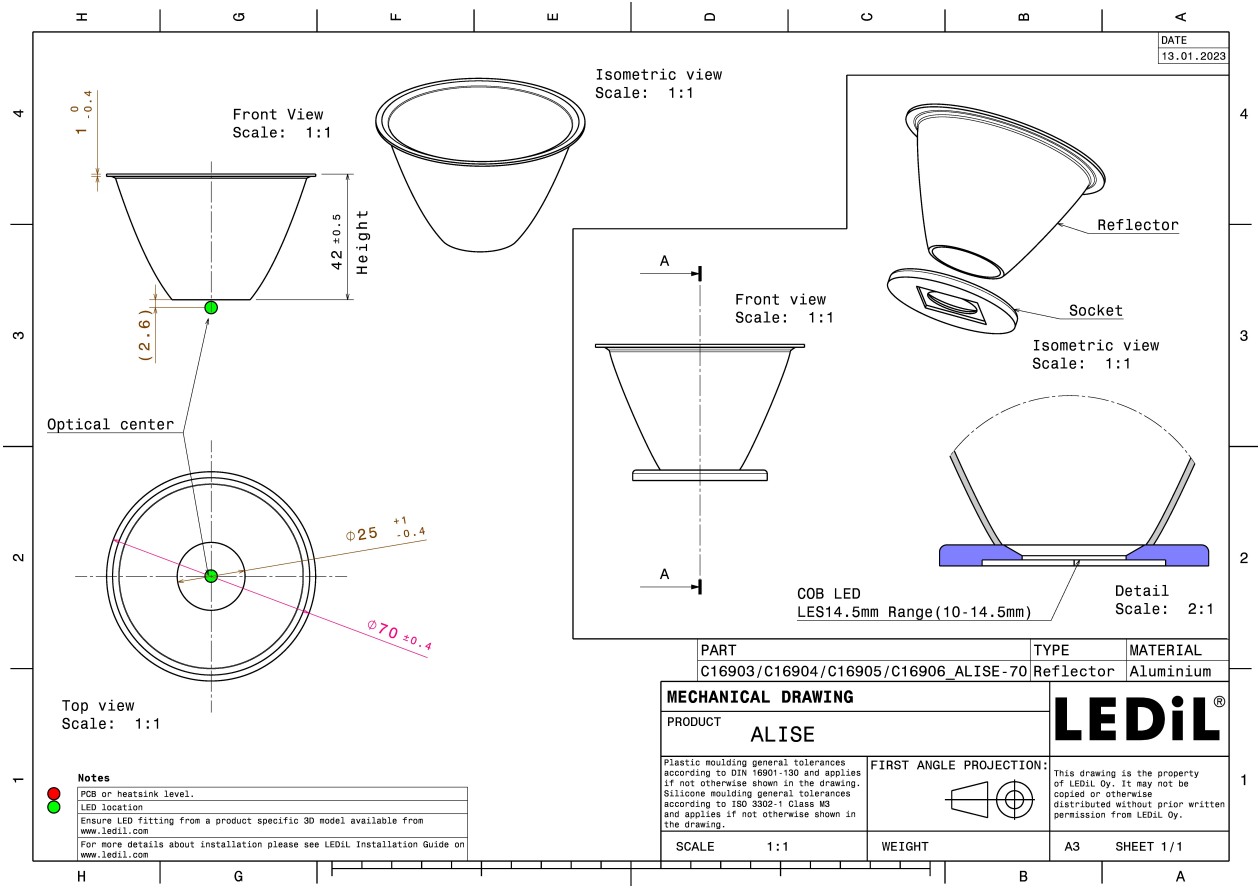



ORDERING INFORMATION:

Component	Qty in box	MOQ	MPQ	Box weight (kg)
C16905_ALISE-70-W » Box size: 410 x 335 x 200 mm	500	100	25	8.6

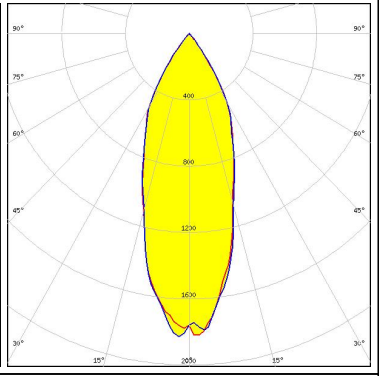

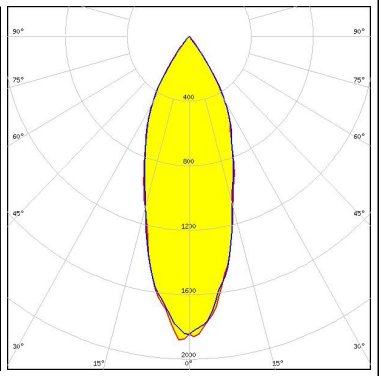
See also our general installation guide: www.ledil.com/installation_guide

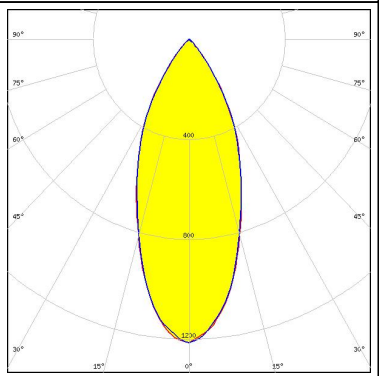
OPTICAL RESULTS (SIMULATED):

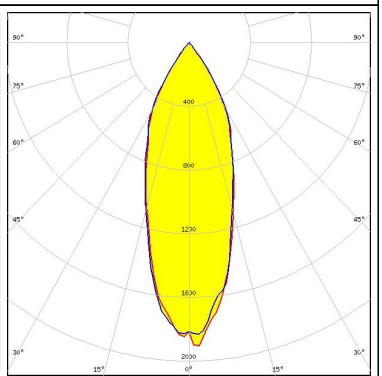
<p></p> <p>LED V13 Gen7 FWHM / FWTM 37.0° / 72.0° Efficiency 92 % Peak intensity 1.9 cd/lm LEDs/each optic 1 Light colour White Required components:</p>		
<p>CITIZEN</p> <p>LED CLL03x/CLU03x FWHM / FWTM 36.0° / 72.0° Efficiency 91 % Peak intensity 1.9 cd/lm LEDs/each optic 1 Light colour White Required components:</p>		
<p>CITIZEN</p> <p>LED CLL03x/CLU03x FWHM / FWTM 42.0° / 78.0° Efficiency 74 % Peak intensity 1.2 cd/lm LEDs/each optic 1 Light colour White Required components: C17098_ALISE-70-DL</p>		
<p></p> <p>LED LUXEON CoB 1204/1205 FWHM / FWTM 36.0° / 72.0° Efficiency 92 % Peak intensity 1.9 cd/lm LEDs/each optic 1 Light colour White Required components:</p>		

OPTICAL RESULTS (SIMULATED):

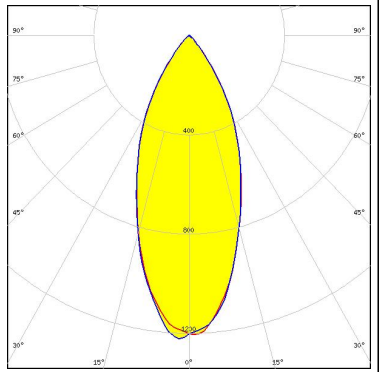
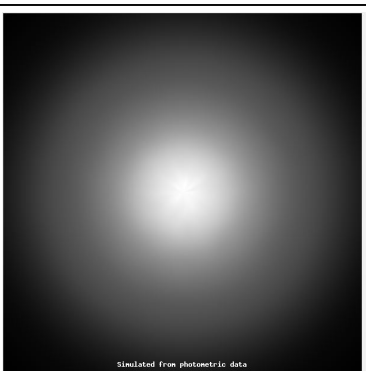
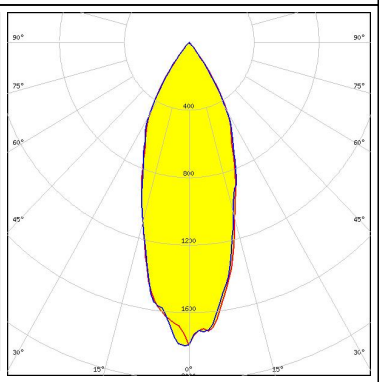
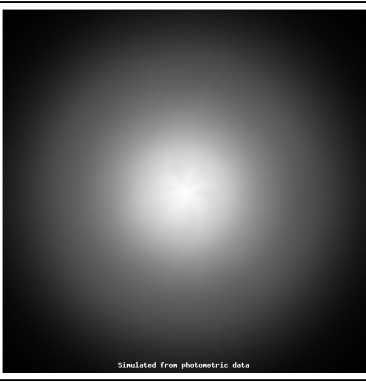
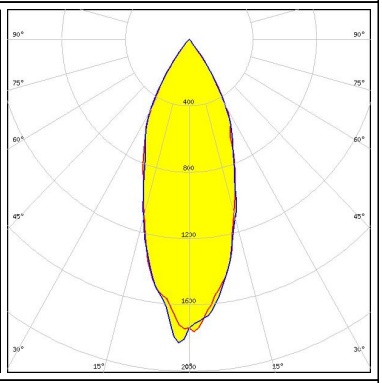
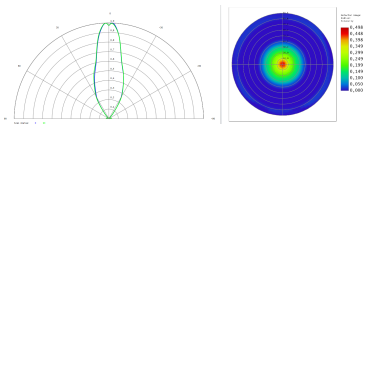
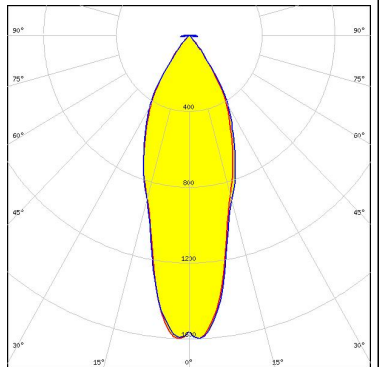
<p>LUMILEDS</p> <p>LED: LUXEON CoB 1208 FWHM / FWTM: 42.0° / 78.0° Efficiency: 74 % Peak intensity: 1.2 cd/lm LEDs/each optic: 1 Light colour: White Required components: C17098_ALISE-70-DL</p>		
<p>LUMILEDS</p> <p>LED: LUXEON CoB 1208 FWHM / FWTM: 38.0° / 72.0° Efficiency: 91 % Peak intensity: 1.9 cd/lm LEDs/each optic: 1 Light colour: White Required components:</p>		
<p>SAMSUNG</p> <p>LED: LC016D / LC019D / LC026D / LC033D FWHM / FWTM: 38.0° / 74.0° Efficiency: 91 % Peak intensity: 1.8 cd/lm LEDs/each optic: 1 Light colour: White Required components:</p>		
<p>SEOUL SEMICONDUCTOR</p> <p>LED: WICOP DY9560-27 FWHM / FWTM: 36.0° / 74.0° Efficiency: 88 % LEDs/each optic: 24 Light colour: UV-C Required components:</p> <p>The UVC LED result tolerance is ±10 %</p>		

OPTICAL RESULTS (SIMULATED):

TRIDONIC

LED SLE G7 LES21
FWHM / FWTM 46.0° / 80.0°
Efficiency 93 %
Peak intensity 1.5 cd/lm
LEDs/each optic 1
Light colour White
Required components:

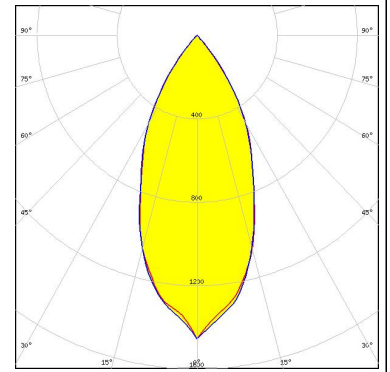

TRIDONIC

LED SLE G7 LES21 H
FWHM / FWTM 44.0° / 76.0°
Efficiency 89 %
Peak intensity 1.5 cd/lm
LEDs/each optic 1
Light colour White
Required components:

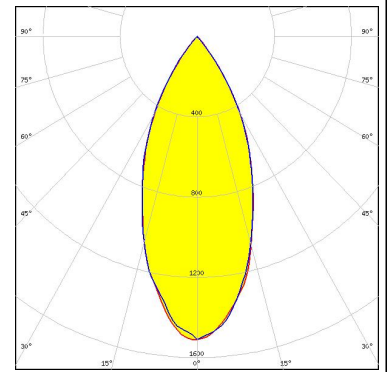

GENERAL INFORMATION:

NOTE: The typical beam angle will be changed by different color, chip size and chip position tolerance. The typical total beam angle is the full angle measured where the luminous intensity is half of the peak value.

Due to use of high power COB's with this product, special attention to proper thermal design is highly recommended. LEDiL has no liability for direct, indirect or consecutive damages arising from the LEDiL products being used outside of the recommended temperature range.

MATERIALS:

As part of our continuous research and improvement processes, and to ensure the best possible quality and availability of our products, LEDiL reserves the right to change material grades without notice.

PRODUCT DATA USER AGREEMENT AND DISCLAIMER:

The measured data in the provided downloadable LEDiL Product Datasheets and Mechanical 2D-Drawings is rounded and provided as reference for planning. LEDiL Oy's optical specifications have been verified by conducting performance testing of the products in accordance with the company's quality system. The reported data are averaged results of multiple measurements with typical variation. LEDiL Oy reserves the right to without prior notification make changes and improvements to its products.

LEDiL Oy assumes neither warranty, nor guarantee nor any other liability of any kind for the contents and correctness of the provided data. The provided data has been generated with highest diligence but the provided data may in reality not represent the complete possible variation range of all intrinsic parameters. Therefore, in certain cases a deviation from the provided data could occur.

LEDiL Oy reserves the right to undertake technical changes of its products without further notification which could lead to changes in the provided data. LEDiL Oy assumes no liability of any kind for the possible deviation from any provided data or any other damage resulting from the usage of the provided data.

The user agrees to this disclaimer and user agreement with the download or usage of the provided files.

LEDiL Oy

Joensuunkatu 13
FI-24240 SALO
Finland

LEDiL Inc.

228 West Page Street
Suite D
Sycamore IL 60178
USA

Ledil Optics Technology (Shenzhen) Co., Ltd.

405 , Block B
Casic Motor Building
Shenzhen 518057
P.R.CHINA

Local sales and technical support

[www.ledil.com/
where_to_buy](http://www.ledil.com/where_to_buy)

Shipping locations

Salo, Finland
Hong Kong, China

Distribution Partners

[www.ledil.com/
where_to_buy](http://www.ledil.com/where_to_buy)