

har-modular P module male str with guide



Image is for illustration purposes only. Please refer to product description.

Part number	02 53 900 0006
Specification	har-modular P module male str with guide
HARTING eCatalogue	https://b2b.harting.com/02539000006

Identification

Category	Connectors
Series	har-modular®
Identification	P module P spacer
Element	Male connector
Description of the contact	Straight

Version

Width of the module	5.08 mm
Connection type	Mezzanine
PCB fixing	With guiding

Technical characteristics

Insulation resistance	$>10^{11} \Omega$
Limiting temperature	-55 ... +125 °C
Mating cycles	≥ 500
Isolation group	I ($600 \leq CTI$)
Hot plugging	No
Moisture Sensitivity Level (MSL)	1 acc. to ECA/IPC/JEDEC J-STD-020D

Material properties

Material	Polyamide (PA)
Colour	Black



Pushing Performance
Since 1945

Material properties

Material flammability class acc. to UL 94	V-0
RoHS	compliant
ELV status	compliant
China RoHS	e
REACH Annex XVII substances	Not contained
REACH ANNEX XIV substances	Not contained
REACH SVHC substances	Not contained
California Proposition 65 substances	Not contained
Fire protection on railway vehicles	EN 45545-2 (2020-08)
Requirement set with Hazard Levels	R22 (HL 1-3) R23 (HL 1-3)

Specifications and approvals

UL / CSA	UL 1977 ECBT2.E102079 CSA-C22.2 No. 182.3 ECBT8.E102079
Railway classification	F1/I2 acc. to NFF 16-101/102

Commercial data

Packaging size	20
Net weight	0.8 g
Country of origin	Romania
European customs tariff number	85389099
GTIN	5713140197763
eCl@ss	27460201 PCB connector (board connector)

Mating conditions

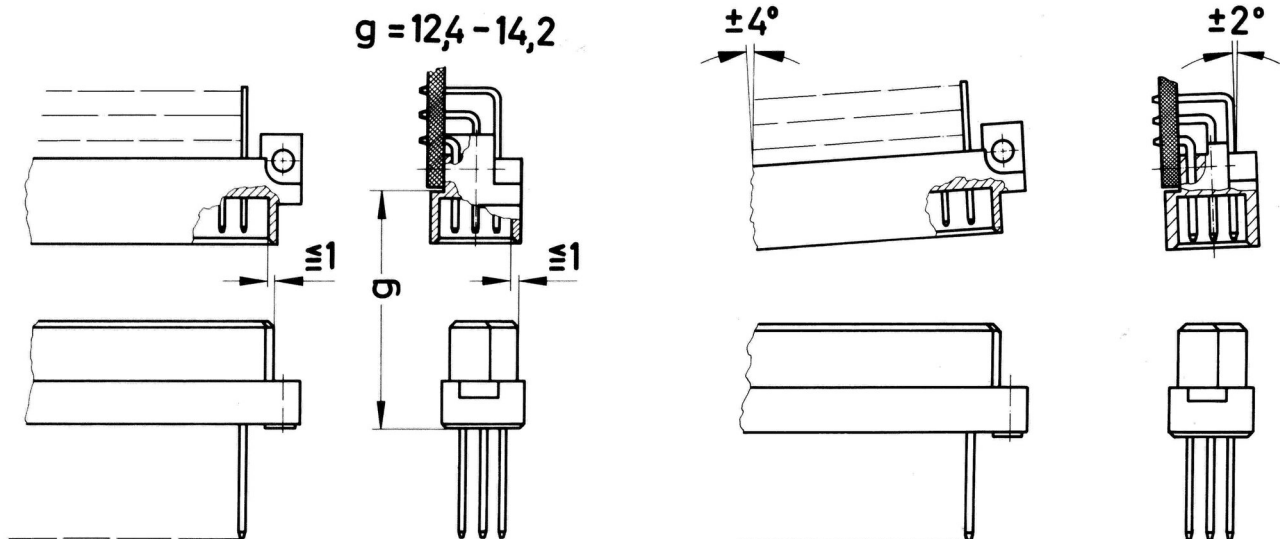

To ensure reliable connections and prevent unnecessary damage, please refer to the application data diagrams. These recommendations are set out in IEC 60603-2. The connectors should not be coupled and decoupled under electrical load.