

## LF412JAN Low Offset, Low Drift Dual JFET Input Operational Amplifier

 Check for Samples: [LF412JAN](#)

### FEATURES

- **Input Offset Voltage Drift: 30  $\mu\text{V}/^\circ\text{C}$  (Max)**
- **Low Input Bias Current: 50 pA (Typ)**
- **Wide Gain Bandwidth: 3 MHz (Typ)**
- **High Slew Rate: 7V/ $\mu\text{s}$  (Min)**
- **High Input Impedance:  $10^{12}\Omega$**
- **Low Total Harmonic Distortion <0.02%**
- **Low 1/f Noise Corner: 50 Hz**
- **Fast Settling Time to 0.01%: 2  $\mu\text{s}$**
- **Low Input Noise Current: 0.01 Pa/ $\sqrt{\text{Hz}}$  (Typ)**

### DESCRIPTION

This device is a low cost, high speed, JFET input operational amplifier with very low input offset voltage and ensured input offset voltage drift. It requires low supply current yet maintains a large gain bandwidth product and fast slew rate. In addition, well matched high voltage JFET input devices provide very low input bias and offset currents. The LF412 dual is pin compatible with the LM1558, allowing designers to immediately upgrade the overall performance of existing designs.

This amplifier may be used in applications such as high speed integrators, fast D/A converters, sample and hold circuits and many other circuits requiring low input offset voltage and drift, low input bias current, high input impedance, high slew rate and wide bandwidth.

### Connection Diagram

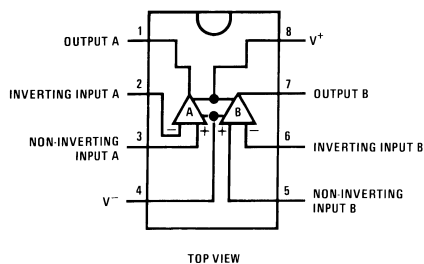

**Figure 1. Dual-In-Line Package**  
See Package Number NAB0008A

### Simplified Schematic

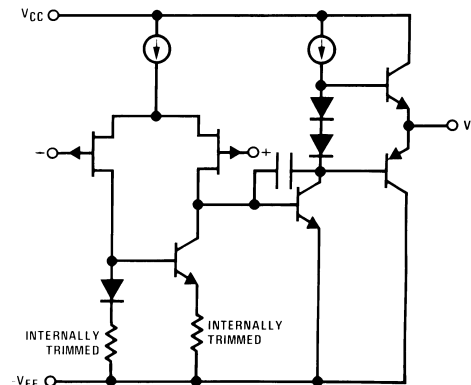

**Figure 2. 1/2 Dual**



Please be aware that an important notice concerning availability, standard warranty, and use in critical applications of Texas Instruments semiconductor products and disclaimers thereto appears at the end of this data sheet.

BI-FET II is a trademark of Texas Instruments.

All other trademarks are the property of their respective owners.

Detailed Schematic

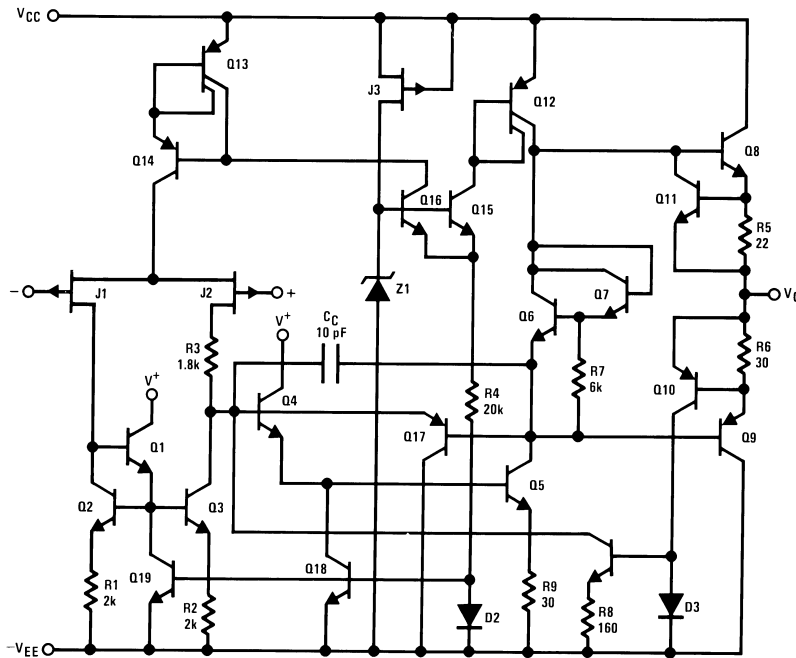

These devices have limited built-in ESD protection. The leads should be shorted together or the device placed in conductive foam during storage or handling to prevent electrostatic damage to the MOS gates.

Absolute Maximum Ratings<sup>(1)</sup>

Supply Voltage			±18V
Differential Input Voltage			±30V
Input voltage Range <sup>(2)</sup>			±15V
Output Short Circuit Duration <sup>(3)</sup>			Continuous
Power Dissipation <sup>(4)</sup>	CDIP Package		800mW
T <sub>Jmax</sub>			175°C
Thermal Resistance	θ <sub>JA</sub>	CDIP Package (Still Air)	122°C/W
		CDIP Package (500 LF/Min Air Flow)	66°C/W
	θ <sub>JC</sub>	CDIP Package	15°C/W
Supply voltage Range			±5V to ±15V
Operating Temperature Range			-55°C ≤ T <sub>A</sub> ≤ 125°C
Storage Temperature Range			-65°C ≤ T <sub>A</sub> ≤ 150°C
Lead Temperature Soldering (10 Sec)			260°C
ESD Tolerance <sup>(5)</sup>			1,700V

- (1) Absolute Maximum Ratings indicate limits beyond which damage to the device may occur. Operating Ratings indicate conditions for which the device is functional, but do not ensure specific performance limits. For ensured specifications and test conditions, see the Electrical Characteristics. The ensured specifications apply only for the test conditions listed. Some performance characteristics may degrade when the device is not operated under the listed test conditions.
- (2) Unless otherwise specified the absolute maximum negative input voltage is equal to the negative power supply voltage.
- (3) Any of the amplifier outputs can be shorted to ground indefinitely, however, more than one should not be simultaneously shorted as the maximum junction temperature will be exceeded.
- (4) The maximum power dissipation must be derated at elevated temperatures and is dictated by T<sub>Jmax</sub> (maximum junction temperature), θ<sub>JA</sub> (package junction to ambient thermal resistance), and T<sub>A</sub> (ambient temperature). The maximum allowable power dissipation at any temperature is P<sub>Dmax</sub> = (T<sub>Jmax</sub> - T<sub>A</sub>)/θ<sub>JA</sub> or the number given in the Absolute Maximum Ratings, whichever is lower.
- (5) Human body model, 1.5 kΩ in series with 100 pF.

**Quality Conformance Inspection**
**Table 1. Mil-Std-883, Method 5005 - Group A**

Subgroup	Description	Temp (°C)
1	Static tests at	+25
2	Static tests at	+125
3	Static tests at	-55
4	Dynamic tests at	+25
5	Dynamic tests at	+125
6	Dynamic tests at	-55
7	Functional tests at	+25
8A	Functional tests at	+125
8B	Functional tests at	-55
9	Switching tests at	+25
10	Switching tests at	+125
11	Switching tests at	-55
12	Settling time at	+25
13	Settling time at	+125
14	Settling time at	-55

## Electrical Characteristics DC Parameters

The following conditions apply, unless otherwise specified.  $\pm V_{CC} = \pm 15V$ ,  $V_{CM} = 0V$

Symbol	Parameter	Conditions	Notes	Min	Max	Unit	Sub-group
$V_{IO}$	Input Offset Voltage	$+V_{CC} = 26V, -V_{CC} = -4V,$ $V_{CM} = -11V$		-5.0	5.0	mV	1
				-7.0	7.0	mV	2, 3
		$+V_{CC} = 4V, -V_{CC} = -26V,$ $V_{CM} = 11V$		-5.0	5.0	mV	1
				-7.0	7.0	mV	2, 3
		$\pm V_{CC} = \pm 5V$		-5.0	5.0	mV	1
				-7.0	7.0	mV	2, 3
$\pm I_{IB}$	Input Bias Current	$+V_{CC} = 26V, -V_{CC} = -4V,$ $V_{CM} = -11V$		-0.4	0.2	nA	1
				-10	50	nA	2
		$+V_{CC} = 4V, -V_{CC} = -26V,$ $V_{CM} = 11V$		-0.2	0.2	nA	1
				-10	50	nA	2
		$+V_{CC} = 4V, -V_{CC} = -26V,$ $V_{CM} = 11V$		-0.2	1.2	nA	1
				-10	70	nA	2
$I_{IO}$	Input Offset Current			-0.1	0.1	nA	1
				-20	20	nA	2
+PSRR	Power Supply Rejection Ratio	$+V_{CC} = 20V$ to $10V, -V_{CC} = -15V$		80		dB	1, 2, 3
-PSRR	Power Supply Rejection Ratio	$+V_{CC} = 15V, -V_{CC} = -20V$ to $-10V$		80		dB	1, 2, 3
CMRR	Input Voltage Common Mode Rejection	$V_{CM} = -11V$ to $+11V$		80		dB	1, 2, 3
+ $I_{OS}$	Output Short Circuit Current	$t \leq 25mS$		-80		mA	1, 2, 3
- $I_{OS}$	Output Short Circuit Current	$t \leq 25mS$			80	mA	1, 2, 3
$I_{CC}$	Supply Current				7.0	mA	1, 2
					8.0	mA	3
$\Delta V_{IO} / \Delta T$	Input Offset Voltage	$25^{\circ}C \leq T_A \leq +125^{\circ}C$	See <sup>(1)</sup>	-30	30	$\mu V/^{\circ}C$	2
		$-55^{\circ}C \leq T_A \leq 25^{\circ}C$		-30	30	$\mu V/^{\circ}C$	3
+ $V_{OP}$	Output Voltage Swing	$R_L = 10K\Omega$		12		V	4, 5, 6
		$R_L = 2K\Omega$		10		V	4, 5, 6
- $V_{OP}$	Output Voltage Swing	$R_L = 10K\Omega$			-12	V	4, 5, 6
		$R_L = 2K\Omega$			-10	V	4, 5, 6
- $A_{VS}$	Open Loop Voltage Gain	$R_L = 2K\Omega, V_O = -10V$	See <sup>(2)</sup>	50		V/mV	4
				25		V/mV	5, 6
+ $A_{VS}$	Open Loop Voltage Gain	$R_L = 2K\Omega, V_O = 10V$	See <sup>(2)</sup>	50		V/mV	4
				25		V/mV	5, 6
$A_{VS}$	Open Loop Voltage Gain	$R_L = 10K\Omega, V_O = \pm 2V,$ $\pm V_{CC} = \pm 5V$	See <sup>(2)</sup>	20		V/mV	4, 5, 6

(1) Calculated parameter.

(2) Datalog reading in  $K = V/mV$ .

### Electrical Characteristics AC Parameters

The following conditions apply, unless otherwise specified.  $\pm V_{CC} = \pm 15V$ ,  $V_{CM} = 0V$

Symbol	Parameter	Conditions	Notes	Min	Max	Unit	Sub-group
TR <sub>TR</sub>	Transient Response Rise Time	$A_V = 1$ , $V_I = 50mV$ , $C_L = 100pF$ , $R_L = 2K\Omega$	See <sup>(1)</sup>		200	nS	7, 8A, 8B
TR <sub>OS</sub>	Transient Response Overshoot	$A_V = 1$ , $V_I = 50mV$ , $C_L = 100pF$ , $R_L = 2K\Omega$	See <sup>(1)</sup>		40	%	7, 8A, 8B
SR+	Slew Rate	$V_I = -5V$ to $+5V$		7.0		V/ $\mu$ S	7
				5.0		V/ $\mu$ S	8A, 8B
SR-	Slew Rate	$V_I = +5V$ to $-5V$		7.0		V/ $\mu$ S	7
				5.0		V/ $\mu$ S	8A, 8B
NI <sub>BB</sub>	Noise Broadband	BW = 10Hz to 15KHz, $R_S = 0\Omega$	See <sup>(2)</sup>		15	$\mu$ V <sub>RMS</sub>	7
NI <sub>PC</sub>	Noise Popcorn	BW = 10Hz to 15KHz, $R_S = 100K\Omega$	See <sup>(2)</sup>		80	$\mu$ V <sub>PK</sub>	7
CS	Channel Separation	$R_L = 2K\Omega$ , $V_I = \pm 10V$	See <sup>(2)</sup>	80		dB	7
$\pm t_S$	Settling Time	$A_V = 1$	See <sup>(1)</sup>		1500	nS	12

(1) Bench test.

(2) Test on either A360, AC or bench test.

### Electrical Characteristics DC Drift Parameters

The following conditions apply, unless otherwise specified.  $\pm V_{CC} = \pm 15V$ ,  $V_{CM} = 0V$

Delta calculations are performed at group B5, only.

Symbol	Parameter	Conditions	Notes	Min	Max	Unit	Sub-group
$V_{IO}$	Input Offset Voltage			-1.0	1.0	mV	1
$\pm I_{IB}$	Input Bias Current			-0.1	0.1	nA	1

### Typical Connection

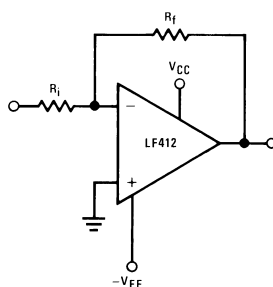

Typical Performance Characteristics

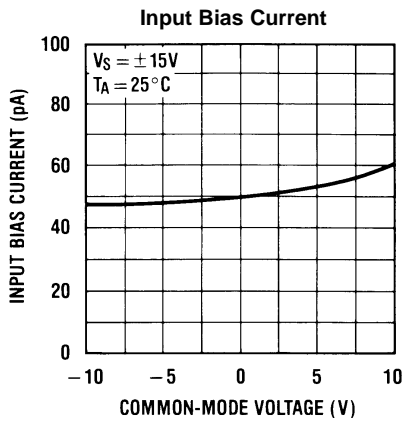

Figure 3.

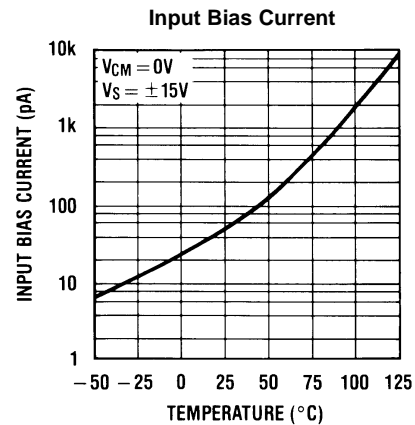

Figure 4.

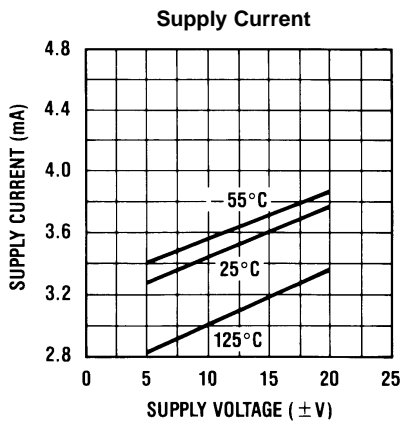

Figure 5.

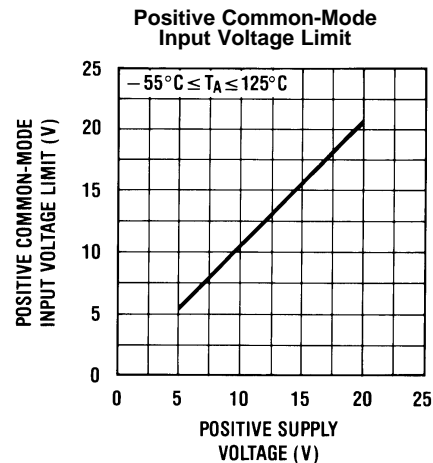

Figure 6.

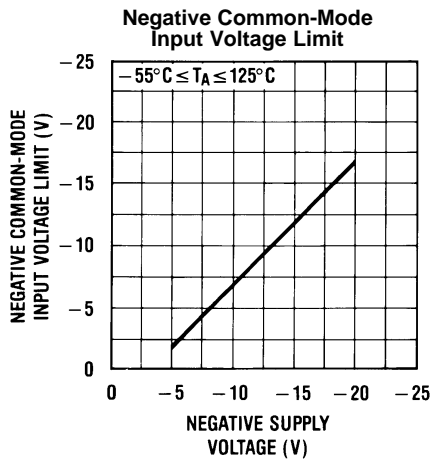

Figure 7.

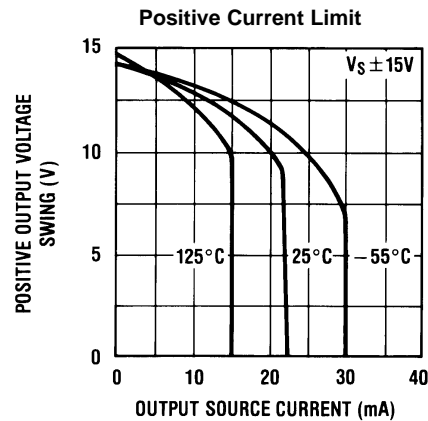

Figure 8.

Typical Performance Characteristics (continued)

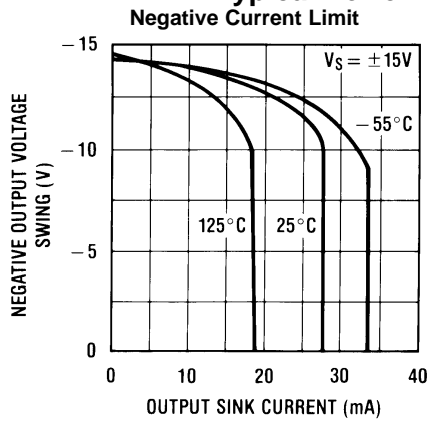

Figure 9.

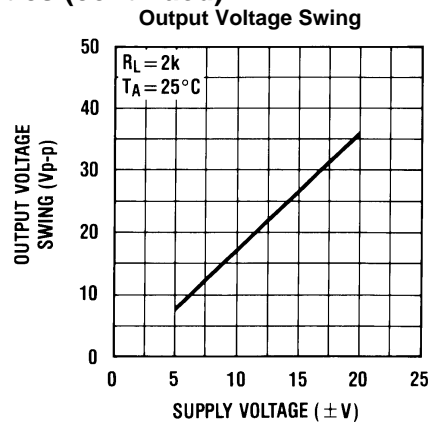

Figure 10.

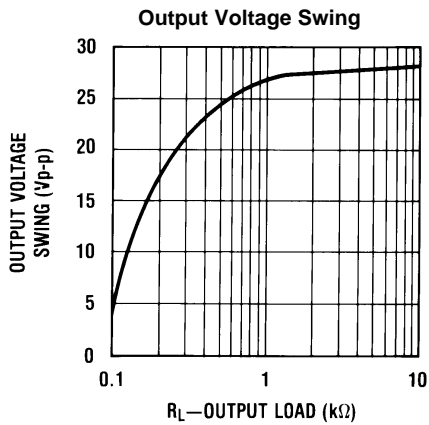

Figure 11.

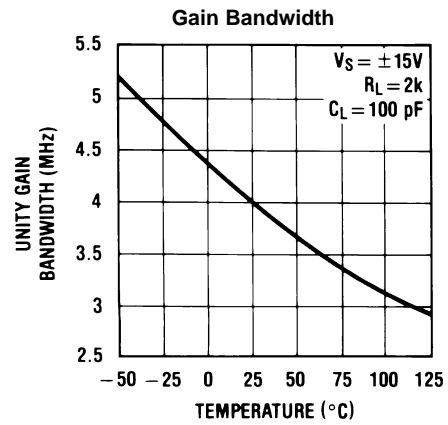

Figure 12.

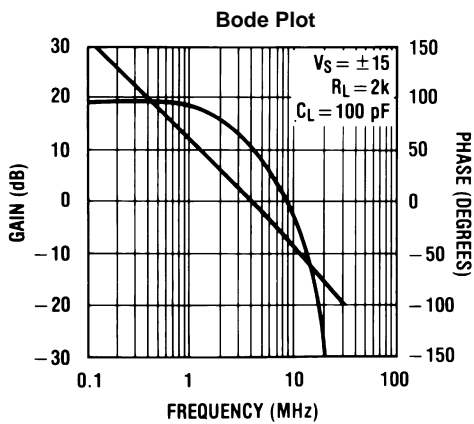

Figure 13.

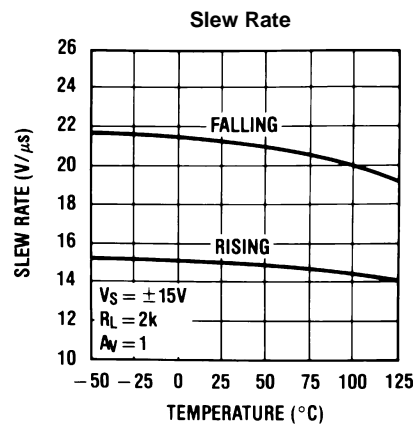

Figure 14.

Typical Performance Characteristics (continued)

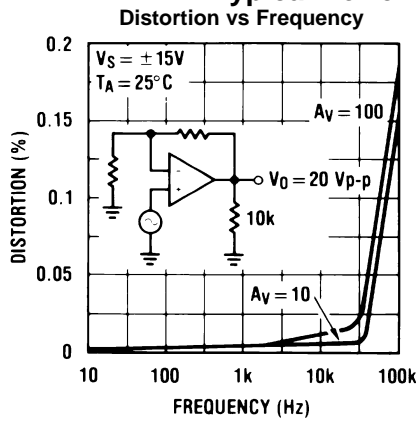

Figure 15.

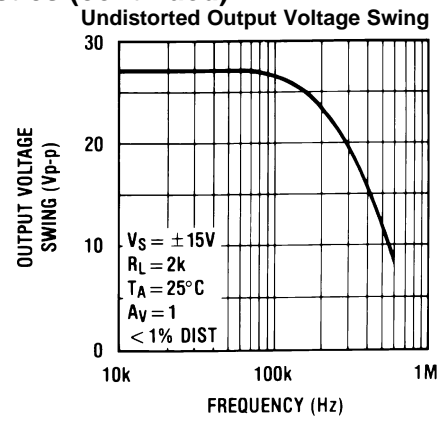

Figure 16.

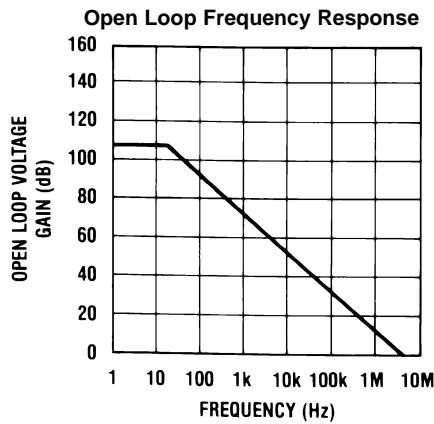

Figure 17.

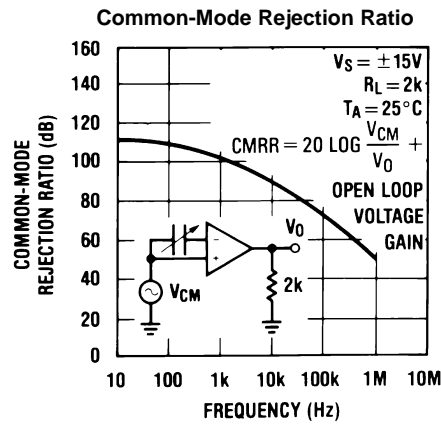

Figure 18.

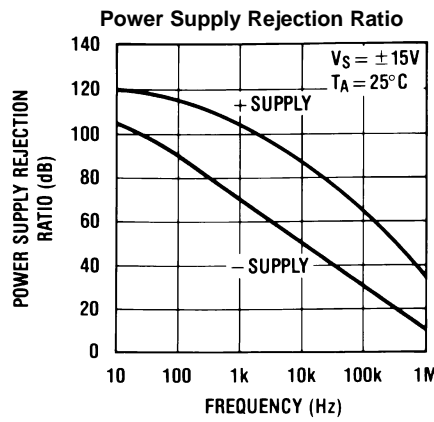

Figure 19.

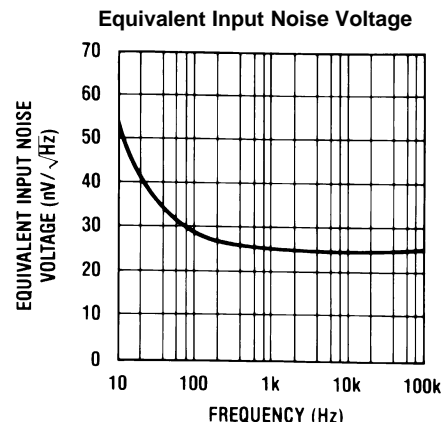

Figure 20.



Typical Performance Characteristics (continued)

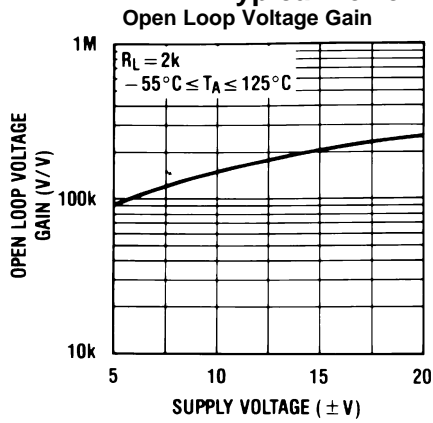

Figure 21.

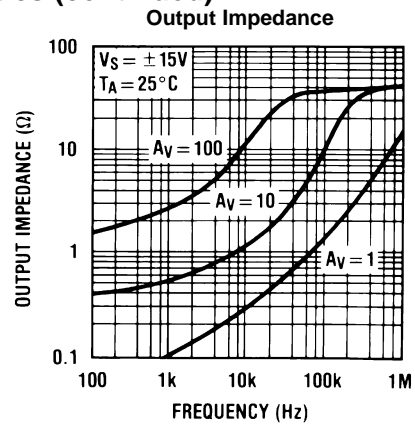

Figure 22.

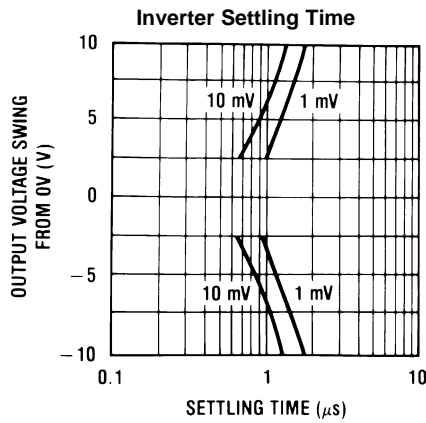
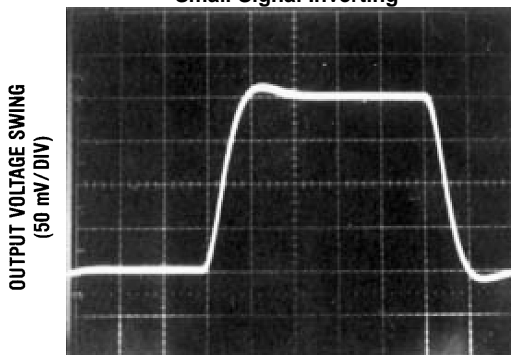

Figure 23.

### Pulse Response

$R_L=2\text{ k}\Omega$ ,  $C_L=10\text{ pF}$

Small Signal Inverting



TIME (0.2  $\mu\text{s}$  / DIV)

Figure 24.

Small Signal Non-Inverting

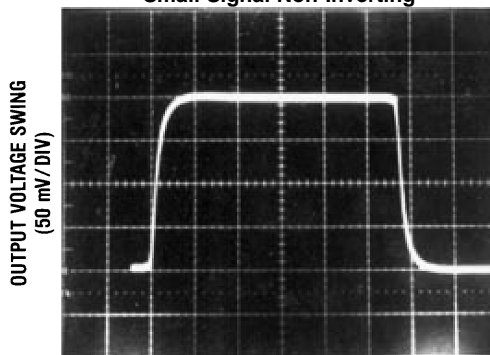

TIME (0.2  $\mu\text{s}$  / DIV)

Figure 25.

Large Signal Inverting

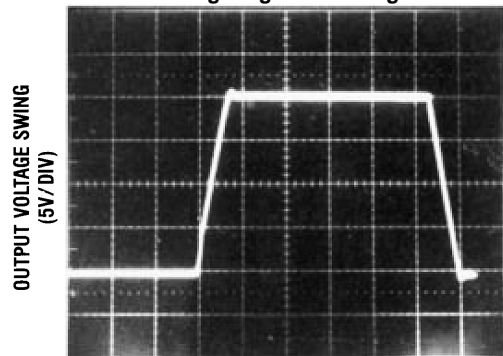

TIME (2  $\mu\text{s}$  / DIV)

Figure 26.

Large Signal Non-Inverting

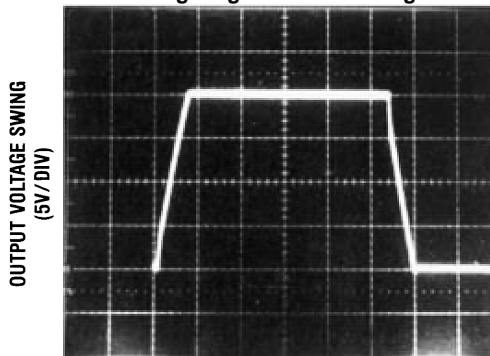

TIME (2  $\mu\text{s}$  / DIV)

Figure 27.

Current Limit ( $R_L=100\Omega$ )

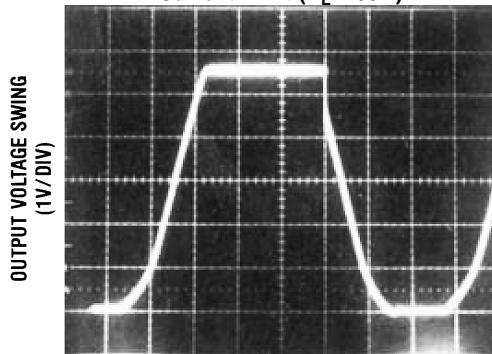

TIME (5  $\mu\text{s}$  / DIV)

Figure 28.

## APPLICATION HINTS

The LF412 JFET input dual op amp is internally trimmed ( BI-FET II™) providing very low input offset voltages and specified input offset voltage drift. These JFETs have large reverse breakdown voltages from gate to source and drain eliminating the need for clamps across the inputs. Therefore, large differential input voltages can easily be accommodated without a large increase in input current. The maximum differential input voltage is independent of the supply voltages. However, neither of the input voltages should be allowed to exceed the negative supply as this will cause large currents to flow which can result in a destroyed unit.

Exceeding the negative common-mode limit on either input will cause a reversal of the phase to the output and force the amplifier output to the corresponding high or low state.

Exceeding the negative common-mode limit on both inputs will force the amplifier output to a high state. In neither case does a latch occur since raising the input back within the common-mode range again puts the input stage and thus the amplifier in a normal operating mode.

Exceeding the positive common-mode limit on a single input will not change the phase of the output, however, if both inputs exceed the limit, the output of the amplifier may be forced to a high state.

The amplifiers will operate with a common-mode input voltage equal to the positive supply; however, the gain bandwidth and slew rate may be decreased in this condition. When the negative common-mode voltage swings to within 3V of the negative supply, an increase in input offset voltage may occur.

Each amplifier is individually biased by a zener reference which allows normal circuit operation on  $\pm 6.0\text{V}$  power supplies. Supply voltages less than these may result in lower gain bandwidth and slew rate.

The amplifiers will drive a 2 k $\Omega$  load resistance to  $\pm 10\text{V}$  over the full temperature range. If the amplifier is forced to drive heavier load currents, however, an increase in input offset voltage may occur on the negative voltage swing and finally reach an active current limit on both positive and negative swings.

Precautions should be taken to ensure that the power supply for the integrated circuit never becomes reversed in polarity or that the unit is not inadvertently installed backwards in a socket as an unlimited current surge through the resulting forward diode within the IC could cause fusing of the internal conductors and result in a destroyed unit.

As with most amplifiers, care should be taken with lead dress, component placement and supply decoupling in order to ensure stability. For example, resistors from the output to an input should be placed with the body close to the input to minimize “pick-up” and maximize the frequency of the feedback pole by minimizing the capacitance from the input to ground.

A feedback pole is created when the feedback around any amplifier is resistive. The parallel resistance and capacitance from the input of the device (usually the inverting input) to AC ground set the frequency of the pole. In many instances the frequency of this pole is much greater than the expected 3 dB frequency of the closed loop gain and consequently there is negligible effect on stability margin. However, if the feedback pole is less than approximately 6 times the expected 3 dB frequency a lead capacitor should be placed from the output to the input of the op amp. The value of the added capacitor should be such that the RC time constant of this capacitor and the resistance it parallels is greater than or equal to the original feedback pole time constant.

Typical Application

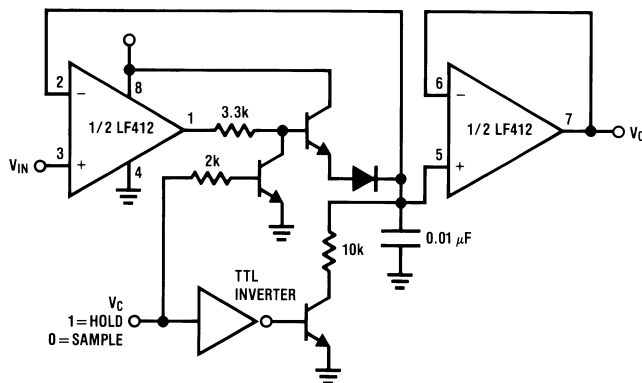

Figure 29. Single Supply Sample and Hold

**REVISION HISTORY**

<b>Date Released</b>	<b>Revision</b>	<b>Section</b>	<b>Changes</b>
12/08/2010	A	New Release to Corporate format	1 MDS datasheet converted into Corporate datasheet format. MJLF412-X Rev 0C1 will be archived.
3/27/2013	A	All Sections	Changed layout of National Data Sheet to TI format

**PACKAGING INFORMATION**

Orderable Device	Status (1)	Package Type	Package Drawing	Pins	Package Qty	Eco Plan (2)	Lead/Ball Finish (6)	MSL Peak Temp (3)	Op Temp (°C)	Device Marking (4/5)	Samples
JL412BPA	OBSOLETE	CDIP	NAB	8		TBD	Call TI	Call TI	-55 to 125	JL412BPA Q JM38510/ 11905BPA ACO 11905BPA >T	

(1) The marketing status values are defined as follows:

**ACTIVE:** Product device recommended for new designs.

**LIFEBUY:** TI has announced that the device will be discontinued, and a lifetime-buy period is in effect.

**NRND:** Not recommended for new designs. Device is in production to support existing customers, but TI does not recommend using this part in a new design.

**PREVIEW:** Device has been announced but is not in production. Samples may or may not be available.

**OBSOLETE:** TI has discontinued the production of the device.

(2) Eco Plan - The planned eco-friendly classification: Pb-Free (RoHS), Pb-Free (RoHS Exempt), or Green (RoHS & no Sb/Br) - please check <http://www.ti.com/productcontent> for the latest availability information and additional product content details.

**TBD:** The Pb-Free/Green conversion plan has not been defined.

**Pb-Free (RoHS):** TI's terms "Lead-Free" or "Pb-Free" mean semiconductor products that are compatible with the current RoHS requirements for all 6 substances, including the requirement that lead not exceed 0.1% by weight in homogeneous materials. Where designed to be soldered at high temperatures, TI Pb-Free products are suitable for use in specified lead-free processes.

**Pb-Free (RoHS Exempt):** This component has a RoHS exemption for either 1) lead-based flip-chip solder bumps used between the die and package, or 2) lead-based die adhesive used between the die and leadframe. The component is otherwise considered Pb-Free (RoHS compatible) as defined above.

**Green (RoHS & no Sb/Br):** TI defines "Green" to mean Pb-Free (RoHS compatible), and free of Bromine (Br) and Antimony (Sb) based flame retardants (Br or Sb do not exceed 0.1% by weight in homogeneous material)

(3) MSL, Peak Temp. - The Moisture Sensitivity Level rating according to the JEDEC industry standard classifications, and peak solder temperature.

(4) There may be additional marking, which relates to the logo, the lot trace code information, or the environmental category on the device.

(5) Multiple Device Markings will be inside parentheses. Only one Device Marking contained in parentheses and separated by a "~" will appear on a device. If a line is indented then it is a continuation of the previous line and the two combined represent the entire Device Marking for that device.

(6) Lead/Ball Finish - Orderable Devices may have multiple material finish options. Finish options are separated by a vertical ruled line. Lead/Ball Finish values may wrap to two lines if the finish value exceeds the maximum column width.

**Important Information and Disclaimer:**The information provided on this page represents TI's knowledge and belief as of the date that it is provided. TI bases its knowledge and belief on information provided by third parties, and makes no representation or warranty as to the accuracy of such information. Efforts are underway to better integrate information from third parties. TI has taken and continues to take reasonable steps to provide representative and accurate information but may not have conducted destructive testing or chemical analysis on incoming materials and chemicals. TI and TI suppliers consider certain information to be proprietary, and thus CAS numbers and other limited information may not be available for release.

In no event shall TI's liability arising out of such information exceed the total purchase price of the TI part(s) at issue in this document sold by TI to Customer on an annual basis.

NAB0008A



CONTROLLING DIMENSION IS INCH  
VALUES IN [ ] ARE MILLIMETERS



J08A (Rev M)



## IMPORTANT NOTICE

Texas Instruments Incorporated and its subsidiaries (TI) reserve the right to make corrections, enhancements, improvements and other changes to its semiconductor products and services per JESD46, latest issue, and to discontinue any product or service per JESD48, latest issue. Buyers should obtain the latest relevant information before placing orders and should verify that such information is current and complete. All semiconductor products (also referred to herein as "components") are sold subject to TI's terms and conditions of sale supplied at the time of order acknowledgment.

TI warrants performance of its components to the specifications applicable at the time of sale, in accordance with the warranty in TI's terms and conditions of sale of semiconductor products. Testing and other quality control techniques are used to the extent TI deems necessary to support this warranty. Except where mandated by applicable law, testing of all parameters of each component is not necessarily performed.

TI assumes no liability for applications assistance or the design of Buyers' products. Buyers are responsible for their products and applications using TI components. To minimize the risks associated with Buyers' products and applications, Buyers should provide adequate design and operating safeguards.

TI does not warrant or represent that any license, either express or implied, is granted under any patent right, copyright, mask work right, or other intellectual property right relating to any combination, machine, or process in which TI components or services are used. Information published by TI regarding third-party products or services does not constitute a license to use such products or services or a warranty or endorsement thereof. Use of such information may require a license from a third party under the patents or other intellectual property of the third party, or a license from TI under the patents or other intellectual property of TI.

Reproduction of significant portions of TI information in TI data books or data sheets is permissible only if reproduction is without alteration and is accompanied by all associated warranties, conditions, limitations, and notices. TI is not responsible or liable for such altered documentation. Information of third parties may be subject to additional restrictions.

Resale of TI components or services with statements different from or beyond the parameters stated by TI for that component or service voids all express and any implied warranties for the associated TI component or service and is an unfair and deceptive business practice. TI is not responsible or liable for any such statements.

Buyer acknowledges and agrees that it is solely responsible for compliance with all legal, regulatory and safety-related requirements concerning its products, and any use of TI components in its applications, notwithstanding any applications-related information or support that may be provided by TI. Buyer represents and agrees that it has all the necessary expertise to create and implement safeguards which anticipate dangerous consequences of failures, monitor failures and their consequences, lessen the likelihood of failures that might cause harm and take appropriate remedial actions. Buyer will fully indemnify TI and its representatives against any damages arising out of the use of any TI components in safety-critical applications.

In some cases, TI components may be promoted specifically to facilitate safety-related applications. With such components, TI's goal is to help enable customers to design and create their own end-product solutions that meet applicable functional safety standards and requirements. Nonetheless, such components are subject to these terms.

No TI components are authorized for use in FDA Class III (or similar life-critical medical equipment) unless authorized officers of the parties have executed a special agreement specifically governing such use.

Only those TI components which TI has specifically designated as military grade or "enhanced plastic" are designed and intended for use in military/aerospace applications or environments. Buyer acknowledges and agrees that any military or aerospace use of TI components which have **not** been so designated is solely at the Buyer's risk, and that Buyer is solely responsible for compliance with all legal and regulatory requirements in connection with such use.

TI has specifically designated certain components as meeting ISO/TS16949 requirements, mainly for automotive use. In any case of use of non-designated products, TI will not be responsible for any failure to meet ISO/TS16949.

### Products

Audio	<a href="http://www.ti.com/audio">www.ti.com/audio</a>
Amplifiers	<a href="http://amplifier.ti.com">amplifier.ti.com</a>
Data Converters	<a href="http://dataconverter.ti.com">dataconverter.ti.com</a>
DLP® Products	<a href="http://www.dlp.com">www.dlp.com</a>
DSP	<a href="http://dsp.ti.com">dsp.ti.com</a>
Clocks and Timers	<a href="http://www.ti.com/clocks">www.ti.com/clocks</a>
Interface	<a href="http://interface.ti.com">interface.ti.com</a>
Logic	<a href="http://logic.ti.com">logic.ti.com</a>
Power Mgmt	<a href="http://power.ti.com">power.ti.com</a>
Microcontrollers	<a href="http://microcontroller.ti.com">microcontroller.ti.com</a>
RFID	<a href="http://www.ti-rfid.com">www.ti-rfid.com</a>
OMAP Applications Processors	<a href="http://www.ti.com/omap">www.ti.com/omap</a>
Wireless Connectivity	<a href="http://www.ti.com/wirelessconnectivity">www.ti.com/wirelessconnectivity</a>

### Applications

Automotive and Transportation	<a href="http://www.ti.com/automotive">www.ti.com/automotive</a>
Communications and Telecom	<a href="http://www.ti.com/communications">www.ti.com/communications</a>
Computers and Peripherals	<a href="http://www.ti.com/computers">www.ti.com/computers</a>
Consumer Electronics	<a href="http://www.ti.com/consumer-apps">www.ti.com/consumer-apps</a>
Energy and Lighting	<a href="http://www.ti.com/energy">www.ti.com/energy</a>
Industrial	<a href="http://www.ti.com/industrial">www.ti.com/industrial</a>
Medical	<a href="http://www.ti.com/medical">www.ti.com/medical</a>
Security	<a href="http://www.ti.com/security">www.ti.com/security</a>
Space, Avionics and Defense	<a href="http://www.ti.com/space-avionics-defense">www.ti.com/space-avionics-defense</a>
Video and Imaging	<a href="http://www.ti.com/video">www.ti.com/video</a>

### TI E2E Community

[e2e.ti.com](http://e2e.ti.com)