

# AFE4400 and AFE4490 Development Guide

---



---



---

This user's guide describes the characteristics, operation, and use of the AFE44x0SPO2EVM demonstration kit. This demonstration kit is an evaluation module (EVM) for the AFE4400 and AFE4490 family of devices. The family of devices are fully-integrated AFE, ideally suited for pulse oximeter applications. The EVM is intended for prototyping and evaluation. This user's guide includes a complete circuit description, schematic diagram, and bill of materials.

The following related documents are available through the Texas Instruments website at [www.ti.com](http://www.ti.com).

Device	Literature Number
AFE4400	<a href="#">SBAS601</a>
AFE4490	<a href="#">SBAS602</a>

## Contents

1	AFE44x0SPO2EVM Overview .....	2
	1.1 Important Disclaimer Information .....	2
2	Overview .....	3
	2.1 Introduction .....	3
	2.2 AFE44x0SPO2EVM Kit Contents.....	3
	2.3 Features Supported in this Version .....	3
3	Software Installation .....	4
	3.1 Minimum Requirements.....	4
	3.2 Installing the Software (PC Application) .....	5
	3.3 Installing the USB Drivers .....	8
4	Running the Software.....	15
	4.1 Overview of the Features .....	15
5	AFE44x0SPO2EVM Hardware .....	27
	5.1 Power Supply .....	29
	5.2 Clock .....	29
	5.3 Accessing AFE44x0 Digital Signals.....	30
	5.4 Analog Inputs .....	30
	5.5 USB Interface .....	30
	5.6 On-Board Key Interface .....	30
	5.7 Visual Indication .....	31
6	USB-Based Firmware Upgrade .....	31
7	GUI Update .....	33
8	Connector Interface .....	34
	8.1 DB9 Pulse Oximeter Connector .....	34
	8.2 Mini USB Connector .....	34
9	Quick Start Guide .....	36
10	AFE44x0SPO2EVM FAQs .....	37
	10.1 EVM Communicating With the PC Application .....	37
	10.2 ADC_RDY Signal.....	37
	10.3 Check TXP and TXM Waveforms.....	38
	10.4 Using an External ADC (Bypass ADC Mode) (Available Only for AFE4490 Device) .....	39
	10.5 Diagnostics.....	39
	10.6 Automation of Register Read and Write Operations.....	39
	10.7 Optimum Viewing Experience on Windows 7 OS.....	40

10.8	Windows 8 Support for Device GUIs .....	40
10.9	COM Port.....	46
11	Bill of Materials .....	47
12	PCB Layouts and Schematics.....	50
12.1	AFE44x0SPO2EVM PCB Layouts .....	50
12.2	AFE44x0SPO2EVM Schematics .....	55

### List of Tables

1	Save Tab Control Descriptions .....	27
2	Test Points for Measuring Voltages on the AFE4490SPO2EVM .....	29
3	Test Points for Measuring Voltages on the AFE4400SPO2EVM .....	29
4	AFE44x0 Digital Signals.....	30
5	AFE44x0SPO2EVM Switches .....	30
6	DB9-Based Pulse Oximeter Connector Pinouts.....	34
7	USB Mini Connector Pinouts .....	35
8	Troubleshoot and Links.....	46
9	AFE44x0SPO2EVM Bill of Materials .....	47

## 1 AFE44x0SPO2EVM Overview

### 1.1 Important Disclaimer Information

#### CAUTION

The AFE44x0SPO2EVM is intended for feasibility and evaluation testing only in laboratory and development environments. This product is not for diagnostic use. This product is not for use with a defibrillator.

Only use the AFE44x0SPO2EVM under the following conditions:

- The AFE44x0SPO2EVM demonstration kit is intended only for electrical evaluation of the features of the AFE44x0 devices in a laboratory, simulation, or development environment.
- The AFE44x0SPO2EVM demonstration kit is not intended for direct interface with a patient, or patient diagnostics.
- The AFE44x0SPO2EVM demonstration kit is intended for development purposes ONLY. It is not intended to be used as all or part of an end-equipment application.
- The AFE44x0SPO2EVM demonstration kit should be used only by qualified engineers and technicians who are familiar with the risks associated with handling electrical and mechanical components, systems, and subsystems.
- The user is responsible for the safety of themselves, fellow employees and contractors, and coworkers when using or handling the AFE44x0SPO2EVM. Furthermore, the user is fully responsible for the contact interface between the human body and electronics; consequently, the user is responsible for preventing electrical hazards such as shock, electrostatic discharge, and electrical overstress of electric circuit components.

Pentium, Celeron are registered trademarks of Intel Corporation.  
Windows is a trademark of Microsoft Corporation.  
Microsoft is a registered trademark of Microsoft Corporation.  
National Instruments is a trademark of National Instruments Corporation.

## 2 Overview

### 2.1 Introduction

**NOTE:** From this point on, unless otherwise noted, AFE44x0 refers to AFE4400- and AFE4490-based demonstration kits.

The EVM is intended for evaluating AFE4400 and AFE4490 devices. The family of devices consist of a low-noise receive channel, the LED transmit section, and diagnostics for sensor and LED fault detection. The AFE44x0 has a highly configurable timing controller, enabling complete control of the device's timing characteristics. The device also has an integrated oscillator working off from two clock sources: either an external crystal or the clock from an external host processor to ease clocking requirements and provide a low-jitter clock to the AFE44x0. The device communicates to the external host processor using the serial peripheral interface (SPI). The purpose of the EVM is to expedite evaluation and system development activities related to AFE44x0 devices. The AFE4490SPO2EVM demonstration kit is shown in [Figure 1](#).

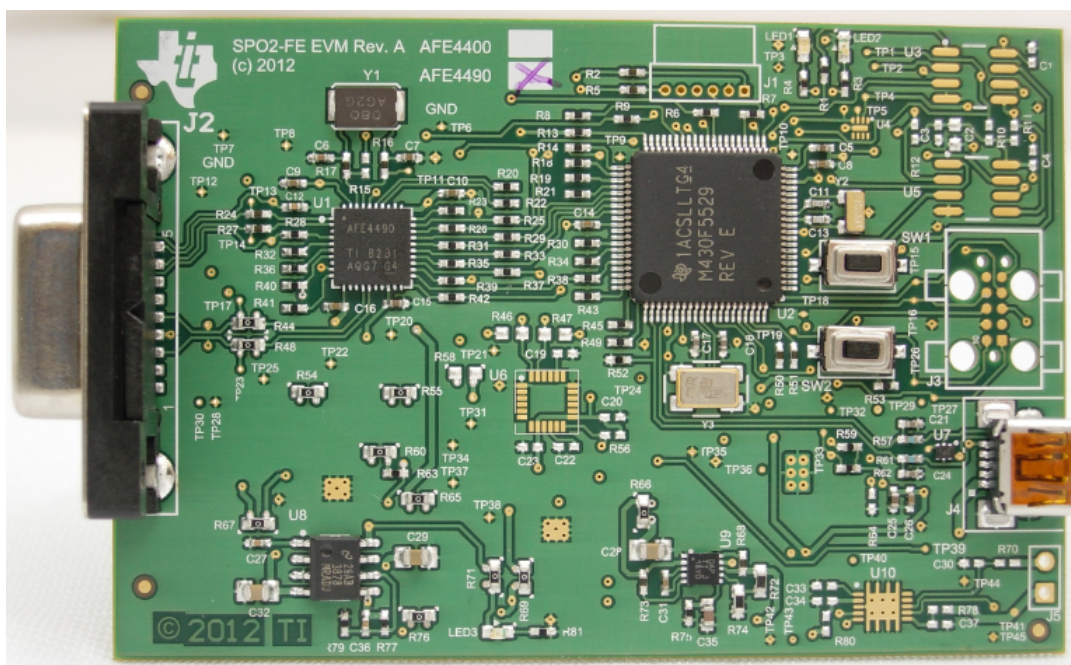

**Figure 1. AFE4490SPO2EVM Demonstration Kit**

The board can be assembled with either of these devices. Check the TI website for the [AFE4400SPO2EVM](#) and [AFE4490SPO2EVM](#) demonstration kits. The MSP430 firmware and PC application are designed to automatically detect and configure to the installed part.

Throughout the document, the term demonstration kit is synonymous with AFE44x0SPO2EVM.

### 2.2 AFE44x0SPO2EVM Kit Contents

- AFE44x0SPO2EVM Demonstration Kit
- USB-to-mini USB cable
- DB9 pulse oximeter cable

### 2.3 Features Supported in this Version

1. DB9 pulse oximeter sensor cable support
2. Acquire data at up to 3000 Hz in evaluation mode
3. USB-based power and PC application connectivity

4. Access to all AFE44x0 registers through an easy-to-use GUI
5. Built-in time domain, histogram, FFT, and related analysis on the PC application
6. USB-based firmware upgrade option

### 3 Software Installation

The latest AFE44x0SPO2EVM PC application software (GUI) is available from the TI website, [AFE4400SPO2EVM GUI](#) and [AFE4490SPO2EVM GUI](#). Download the zipped file to a temporary directory on the PC.

#### 3.1 Minimum Requirements

Before installing the software, verify that your PC meets the minimum requirements outlined in this section.

##### 3.1.1 Required Setup for AFE44x0SPO2EVM Demo Software

- IBM PC-compatible computer
- Pentium® III/ Celeron® 866 MHz or equivalent processor
- Minimum 256 MB of RAM (512 MB or greater recommended)
- Hard disk drive with at least 200 MB free space
- Microsoft® Windows™ XP SP2, Windows 7, or Windows 8 operating system
- 1280 × 1024 or greater display screen resolution

### 3.2 Installing the Software (PC Application)

Before installing the software, make sure the AFE44x0SPO2EVM is NOT connected to the PC. If using a machine with Windows 7 or Windows 8 OS, TI recommends having administrator rights to avoid problems during installation. Unzip the installer file, and then find and double click *setup.exe* to install the software. Unless otherwise specified during the install process, the software installs at the following location:

- On a Windows XP machine
  - C:\Program Files\Texas Instruments\AFE44x0SPO2EVM GUI
- On a Windows 7 or Windows 8 machine
  - C:\Program Files(x86)\Texas Instruments\AFE44x0SPO2EVM GUI

It creates a program menu item, AFE44x0SPO2EVM GUI under *Programs*→*Texas Instruments*→*AFE44x0SPO2EVM GUI* to execute the software. The following steps ensure proper installation of the PC application.

Click *setup.exe* and follow the prompts to continue with the installation process.

Select the destination directory and click the **Next** button.

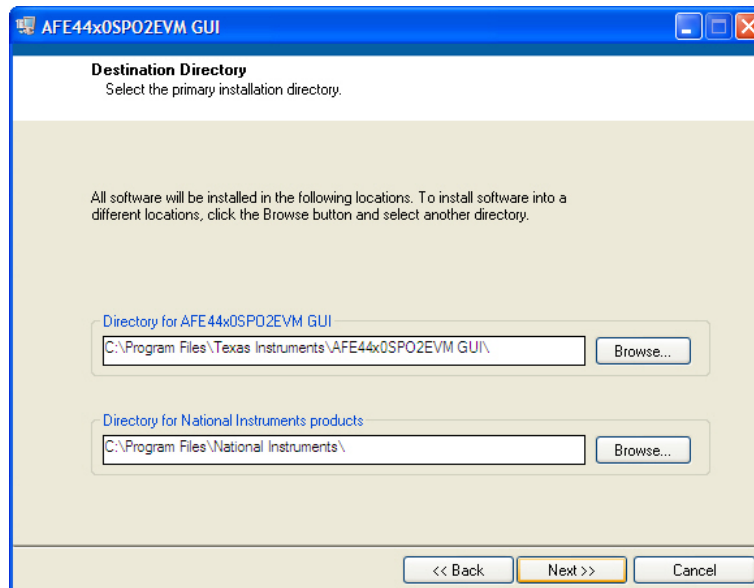

**Figure 2. PC Application Installation – Screen 1**

Accept the Texas Instruments end-user license agreement (EULA) and click the **Next** button.



**Figure 3. PC Application Installation – Screen 2**

Accept the National Instruments™ software license agreement and click the **Next** button.

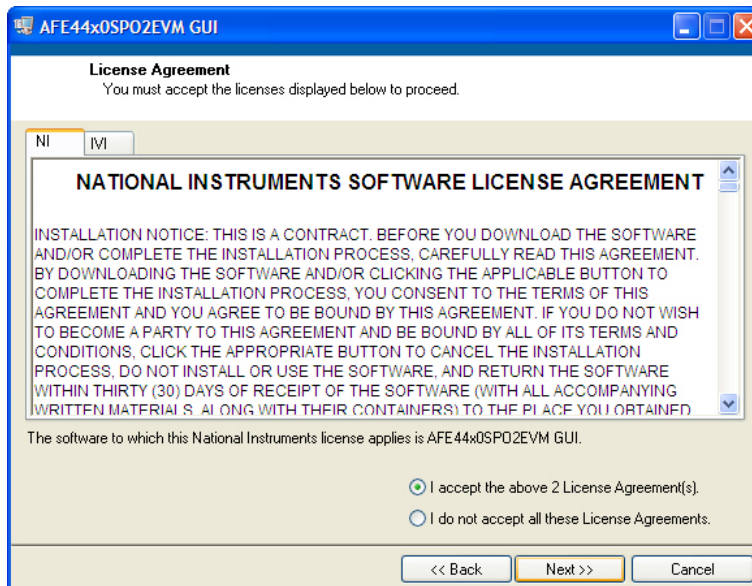

**Figure 4. PC Application Installation – Screen 3**

Click the **Next** button to begin the installation.

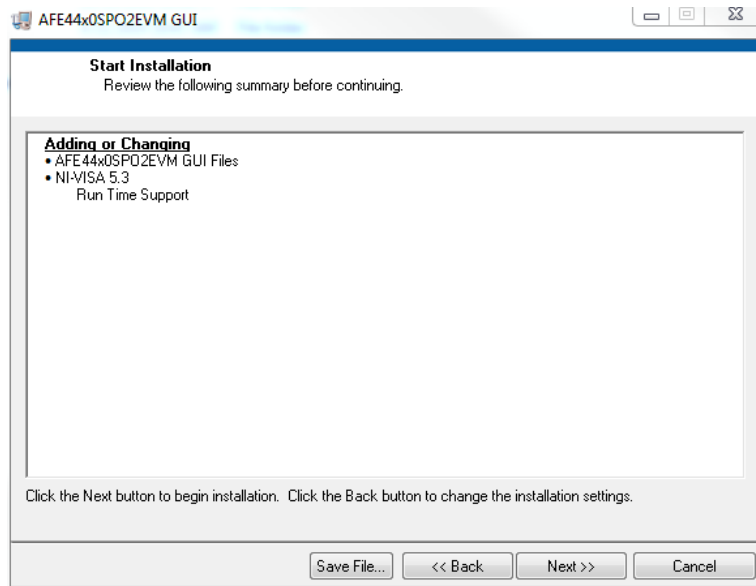

**Figure 5. PC Application Installation – Screen 4**

The application software is now installed. After the installation is complete, click the Next button to continue with the installation of Python v2.7.

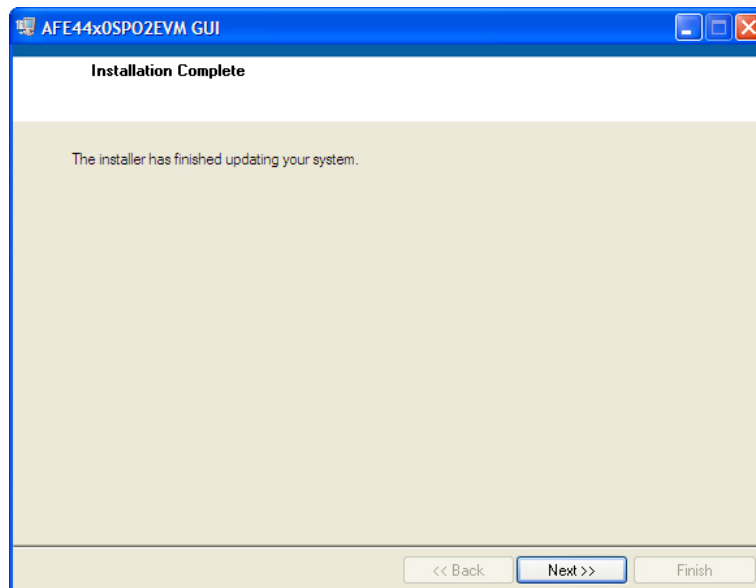

**Figure 6. PC Application Installation – Screen 5**

After the Python v2.7 is installed, click OK. The PC application is now ready to use.

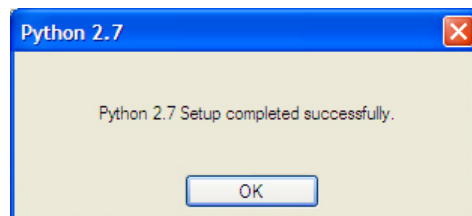

**Figure 7. Python Installation**

### 3.3 Installing the USB Drivers

The communication interface between the AFE44x0SPO2EVM board and PC is through the USB, using the CDC profile. A one-time installation of the USB driver is required for the communication between the AFE44x0SPO2EVM and PC application.

**NOTE:** For Windows 8, signed driver enforcement may have to be disabled. [Section 3.3.1](#) explains how to do this.

Following these steps ensures proper installation of the USB drivers:

1. Plug in the USB-to-mini USB cable to J4 of AFE44x0SPO2EVM and the other end to the USB port on the PC.
2. Win XP OS starts up the *New Hardware Wizard* to enable the user to install the USB driver for the new hardware. The Windows 7 or Windows 8 OS attempts to find the driver for the *new hardware found* automatically and if the driver is not found, there is no pop-up message to indicate that the driver installation failed. In the Windows 7 or Windows 8 OS, click on *Device Manager*, right click on *MSP430-USB* example under *Other devices* and click on *Update Driver Software* as shown in [Figure 8](#). This step is not required for the Windows XP OS.

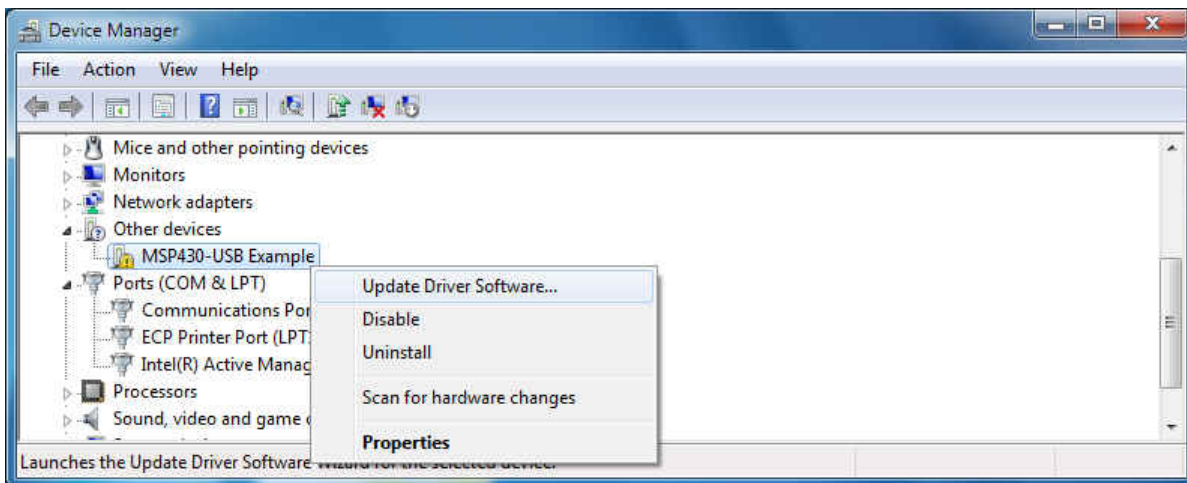

**Figure 8. USB Driver Installation – Screen 1 (Win 7 OS only)**



3. Select the *Install from a list or specific locations (Advanced)* option, and click the **Next** button.



Figure 9. USB Driver Installation – Screen 2

4. As shown in Figure 10, navigate to the directory where the *AFE44x0.inf* file is located by clicking the **Browse** button. The file is located at the following path:
  - On a Windows XP machine:
    - *C:\Program Files\Texas Instruments\AFE44x0SPO2EVM GUI\USB Driver*
  - On a Windows 7 or Windows 8 machine:
    - *C:\Program Files(x86)\Texas Instruments\AFE44x0SPO2EVM GUI\USB Driver*
 Click the **Next** button to continue. The Driver file is copied to the system directory after clicking the **Next** button.

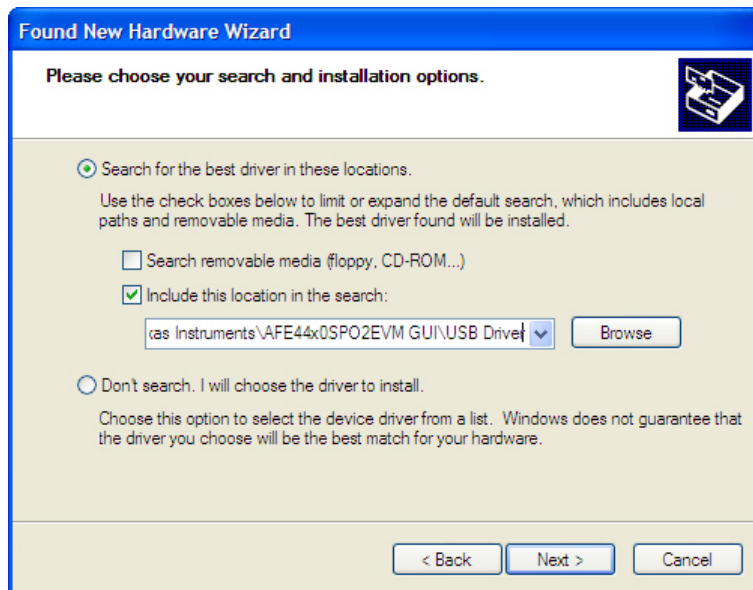
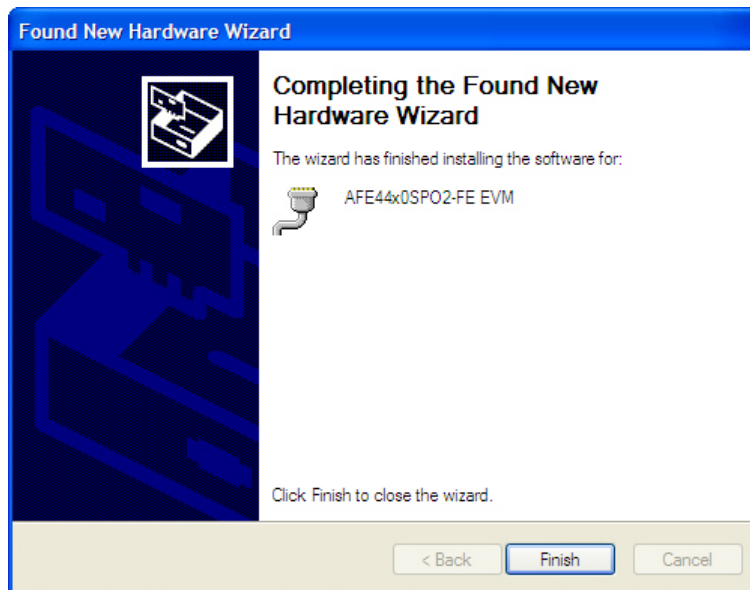

Figure 10. USB Driver Installation – Screen 3

5. Click the **Finish** button after the driver installation is complete (Figure 11).



**Figure 11. USB Driver Installation – Screen 4**

6. The AFE44x0SPO2-FE EVM is now recognized as *Virtual COM Port* under the Device Manager as shown in Figure 12.

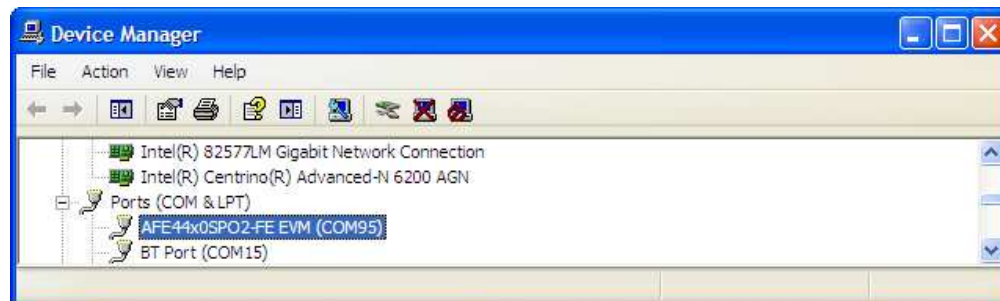

**Figure 12. Device Manager Screen**

The USB driver installation is now complete and the EVM is ready to use.

### 3.3.1 Windows 8 Installing Unsigned Drivers

Perform an advanced startup sequence to let Windows 8 install unsigned drivers.

Move the cursor to the top right of the screen, click settings, then power, then HOLD SHIFT and click Restart as shown in [Figure 13](#).

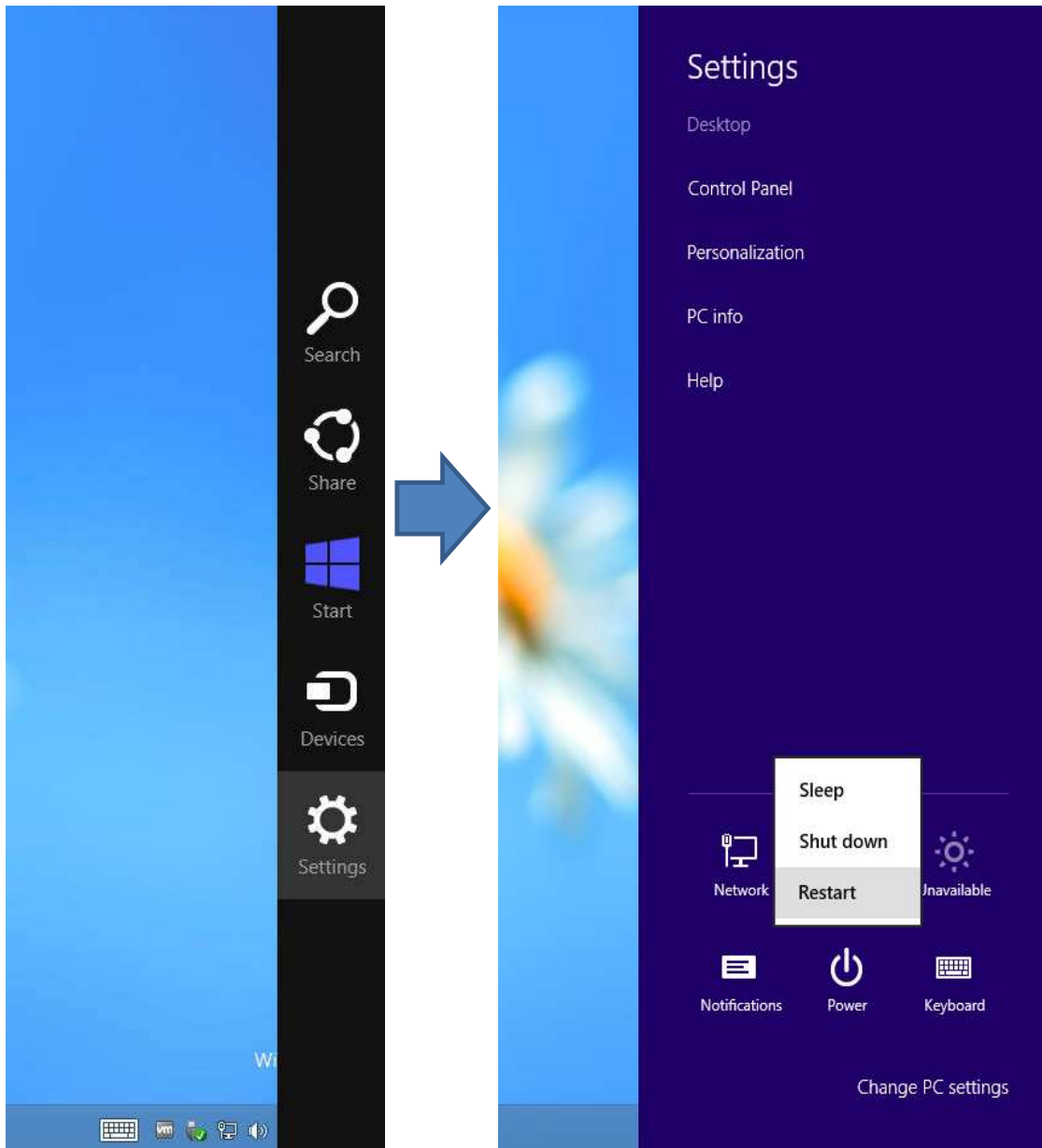

**Figure 13.**

After a loading screen, three options appear. Choose Troubleshoot as shown in [Figure 14](#).

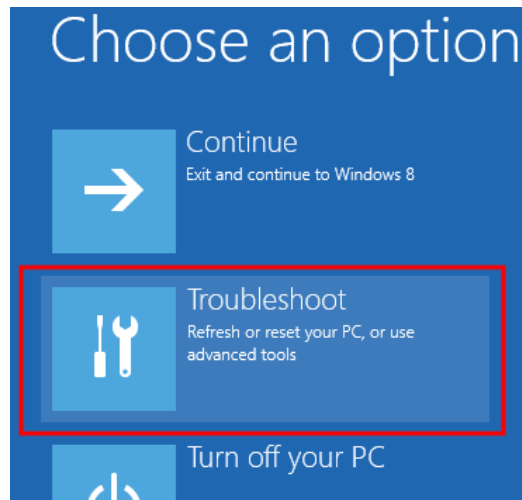

**Figure 14.**

Choose advanced options as shown in [Figure 15](#).

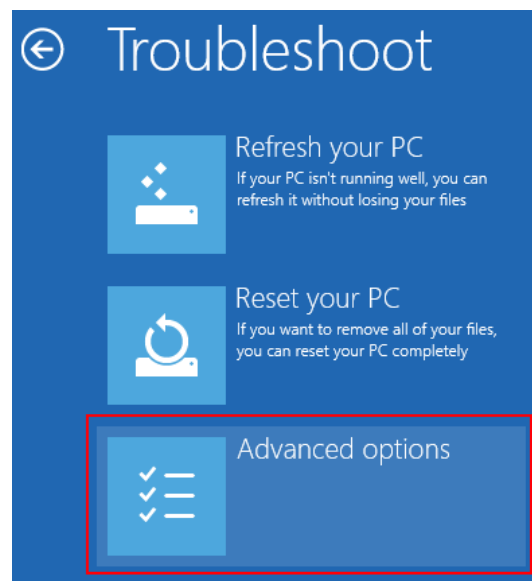

**Figure 15.**

Choose startup Settings as shown in [Figure 16](#).

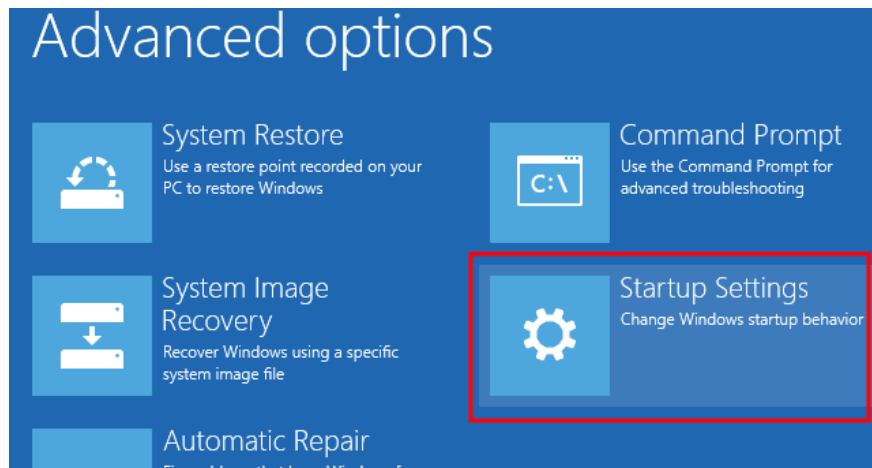

**Figure 16.**

Next a list of options displays. Click Restart at the bottom right as shown in [Figure 17](#).

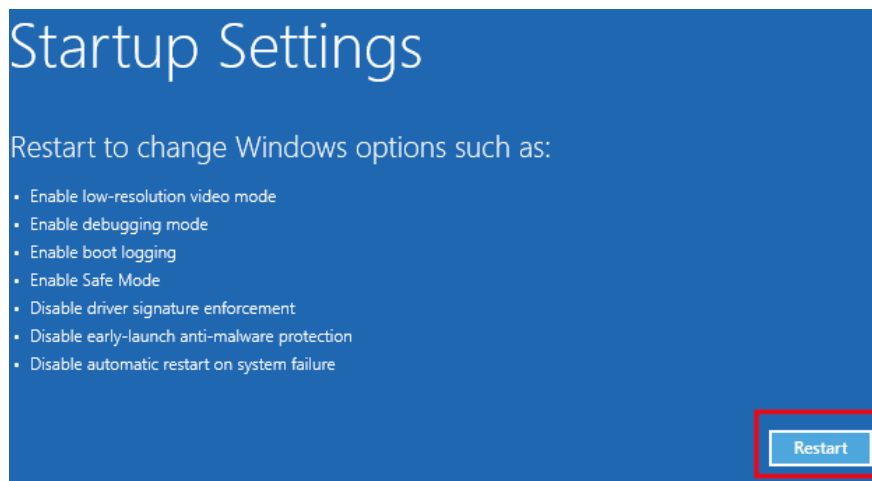

**Figure 17.**

After the computer restarts, the following screen appears (see [Figure 18](#)). Press F7 to disable driver signature enforcement.

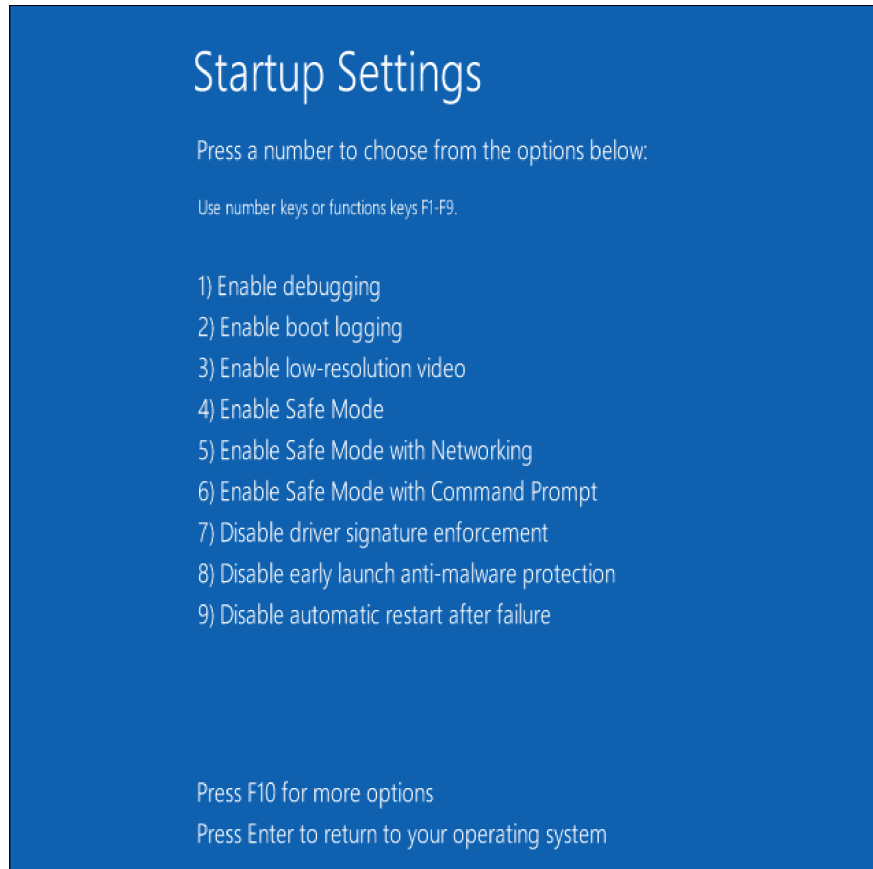

**Figure 18.**

Now, the user can install unsigned drivers. A warning may appear as shown in [Figure 19](#); choose Install this driver software anyway.

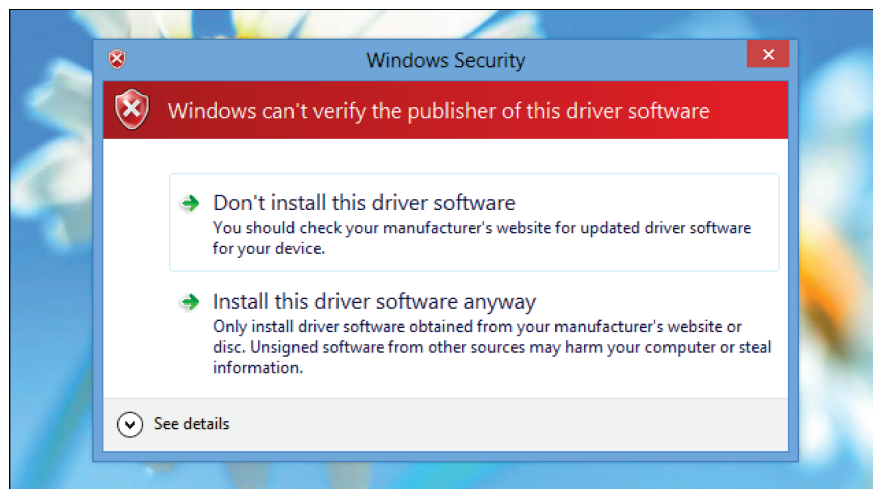

**Figure 19.**

Restart the computer again to re-enable driver signature enforcement after the installation is complete.

## 4 Running the Software

Run the GUI software from the Start menu by selecting *All Programs*→*Texas Instruments*→*AFE44x0SPO2EVM GUI*. Unless the hardware has been disconnected, observe messages that confirm the connection has been established and the program waits in idle mode for user input.

If the connection to the AFE44x0SPO2EVM board is not established, the program prompts to continue to run the GUI in *Simulation* mode, or to Stop and Close the GUI and check if the AFE44x0SPO2EVM is connected to the PC.

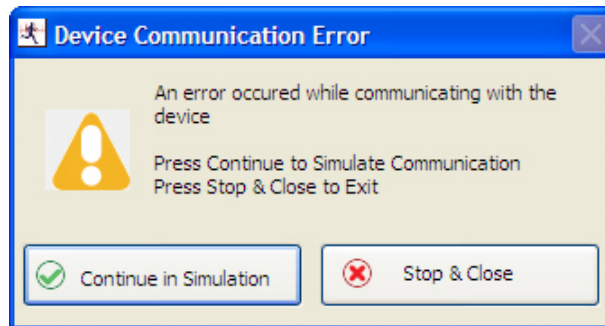

**Figure 20. AFE44x0SPO2EVM Not Connected Error Message**

### 4.1 Overview of the Features

This section provides a quick overview of the various features and functions of the AFE44x0SPO2EVM software GUI. The GUI allows the user to easily configure the various functions of the AFE, such as receiver gain, bandwidth settings, LED current settings, and timing and clocking control settings. The GUI supports both AFE4400 and AFE4490 devices. Features not available for the AFE4400 device are disabled and are not shown in the AFE4400SPO2EVM GUI.

Operations in the GUI should only be performed after the status bar (located at the bottom of the GUI) displays **Ready For New Command** (refer to [Figure 21](#)).

The main tabs consist of:

- *About* – Product Safety Warnings, Restrictions, and Disclaimers (see [Figure 21](#)).
- *Device Configuration* – Configures all the AFE44x0 user registers in a series of related subtabs.
  - *Global Settings*
  - *Tx Stage*
  - *Rx Stage*
  - *Timing Controls*
  - *Low Level Configuration*
- *ADC Capture & Analysis* – For viewing and analyzing the raw data.
- *Save* – For writing data samples and analysis results to a file.

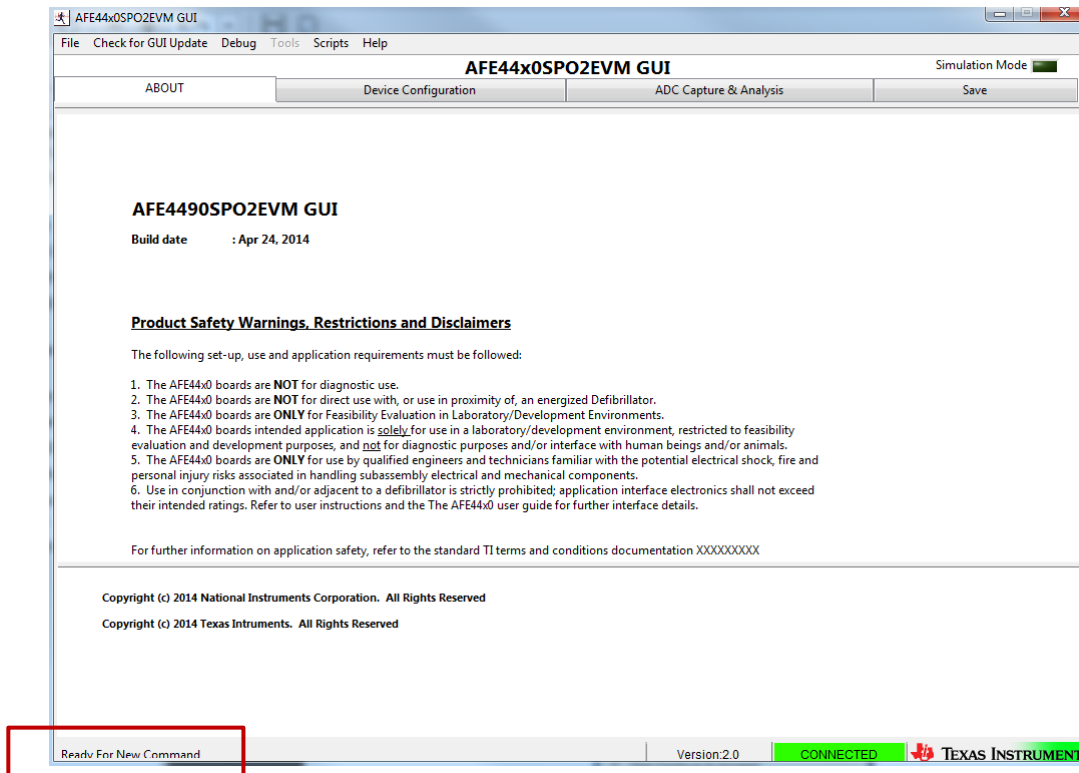

Figure 21. Product Safety Warnings, Restrictions, and Disclaimers

#### 4.1.1 Device Configuration Tab

The *Device Configuration* tab allows configuration of the various registers of the AFE44x0 device. This subtab contains five subtabs: *Global Settings*, *Tx Stage*, *Rx Stage*, *Timing Controls*, and *Low Level Configuration*.

##### 4.1.1.1 Global Settings Subtab

The *Global Settings* subtab for the AFE4490 device shown in [Figure 22](#) and for AFE4400 device shown in [Figure 23](#) has the following features:

1. View the Device ID and Firmware Revision
2. **Device Reset** button that resets the device. (Please note that after a device reset is issued, the AFE44x0 device registers must be programmed correctly for the PC application GUI to function properly. See **Reset to EVM Defaults** on how to issue a device reset and also program the AFE44x0 registers to the EVM default register settings.)
3. **Reset to EVM Defaults** button that resets the device and sets up the board to the EVM default register settings.
4. Enables the user to set or reset:
  - (a) SPI Read
  - (b) XTAL Disable
  - (c) En Bypass ADC (available for AFE4490 device only)
  - (d) Powerdown AFE
  - (e) Powerdown TX
  - (f) Powerdown RX
  - (g) Enable Slow Diag Clock (available for AFE4490 device only)
  - (h) Enable CLKs on ALM Pin and select the following clocks to route to PD\_ALM and LED\_ALM pins



- (i) Sample LED2 and LED1 pulse
  - (ii) LED2 / LED1 LED pulse
  - (iii) Sample LED2 / LED1 Ambient pulse
  - (iv) LED2 / LED1 Convert pulse
  - (v) LED2 / LED1 Ambient Convert pulse
5. Click on *Diagnostic Enable* and view the *Alarm* status flags triggered through *Diagnostic Enable*.

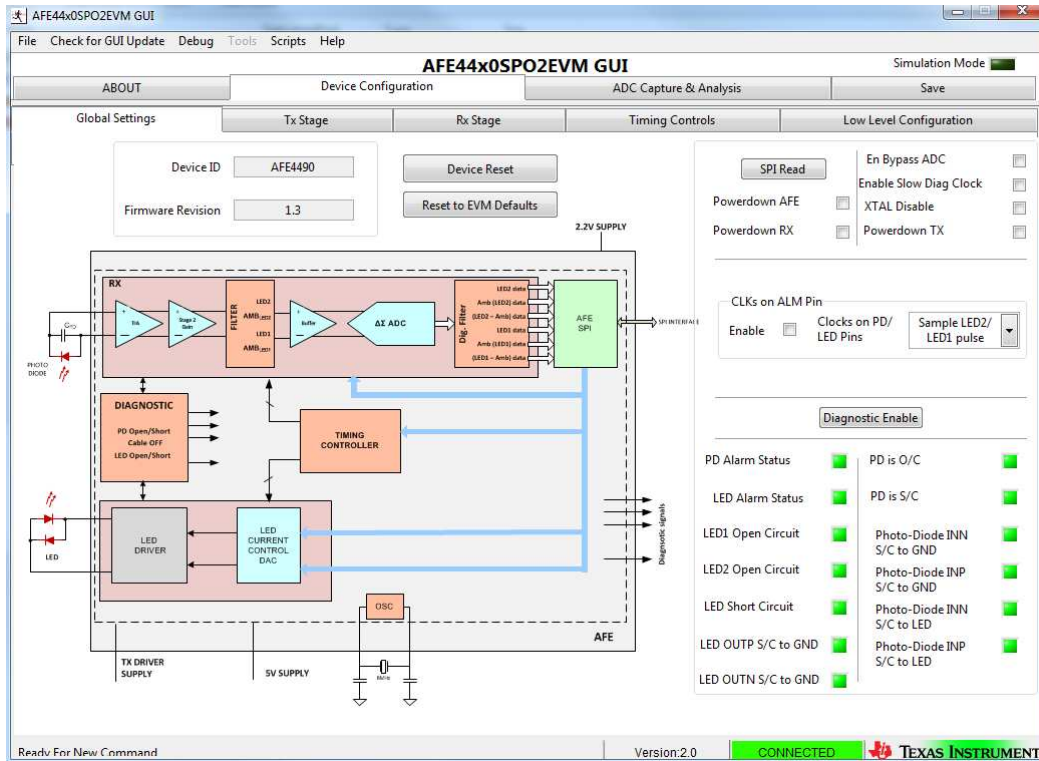

Figure 22. AFE4490: Device Configuration: Global Settings



#### 4.1.1.2 Tx Stage Subtab

The *Tx Stage* subtab under the *Device Configuration* tab, shown in [Figure 24](#) for AFE4490 and [Figure 25](#) for AFE4400, consists of the settings to:

1. Set LED1 and LED2 currents.
2. Program LED current control DAC through a pull-down menu.
3. Program the transmitter reference voltage through a pull-down menu (available for AFE4490 device only).
4. Select between H-bridge mode and Push-pull mode.

---

**NOTE:** The AFE44x0SPO2EVM does not support Push-pull mode.

---

#### 4.1.1.3 Rx Stage Subtab

The *Rx Stage* subtab under the *Device Configuration* tab, shown in [Figure 26](#) for AFE4490 and [Figure 27](#) for AFE4400, consists of the settings to:

1. Enable separate gain mode (available for AFE4490 device only).
2. Set feedback resistance and capacitance for the trans-impedance amplifier with separate gain mode disabled.
3. Set feedback resistance and capacitance for the trans-impedance amplifier with separate gain mode enabled (available for AFE4490 device only).
4. Enable second-stage and set gain for the second-stage amplifier.
5. Set ambient DAC current.
6. Select filter corner frequency (available for AFE4490 device only).

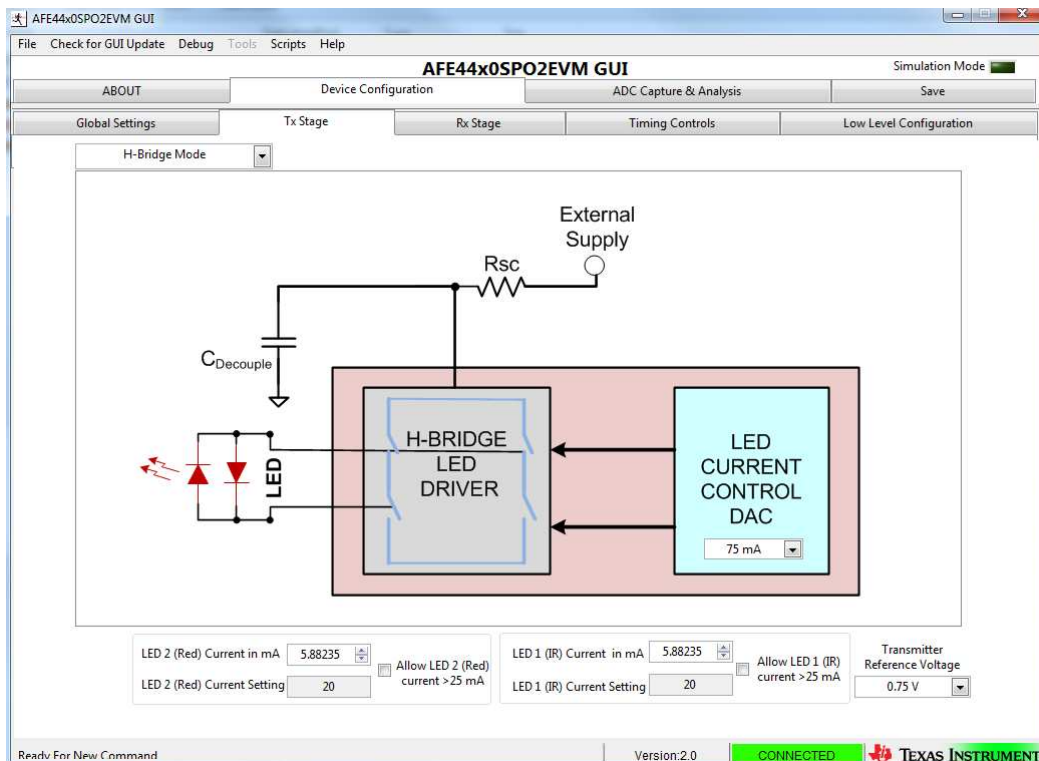

**Figure 24. AFE4490: Device Configuration: Tx Stage**

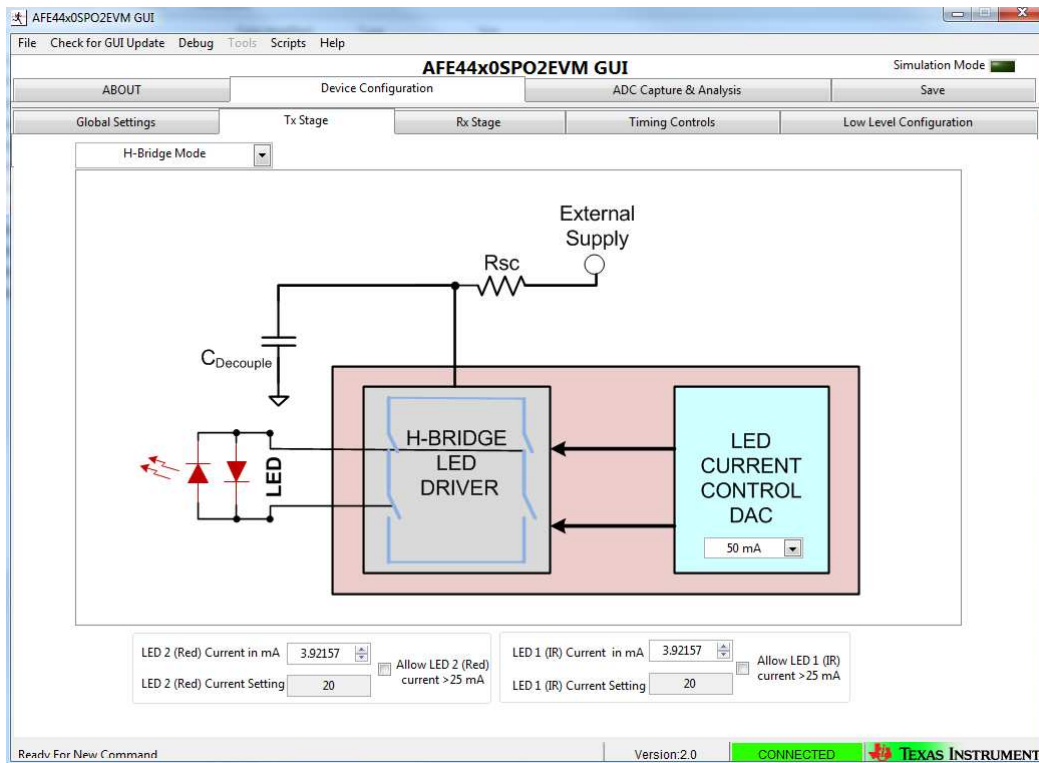

Figure 25. AFE4400: Device Configuration: Tx Stage

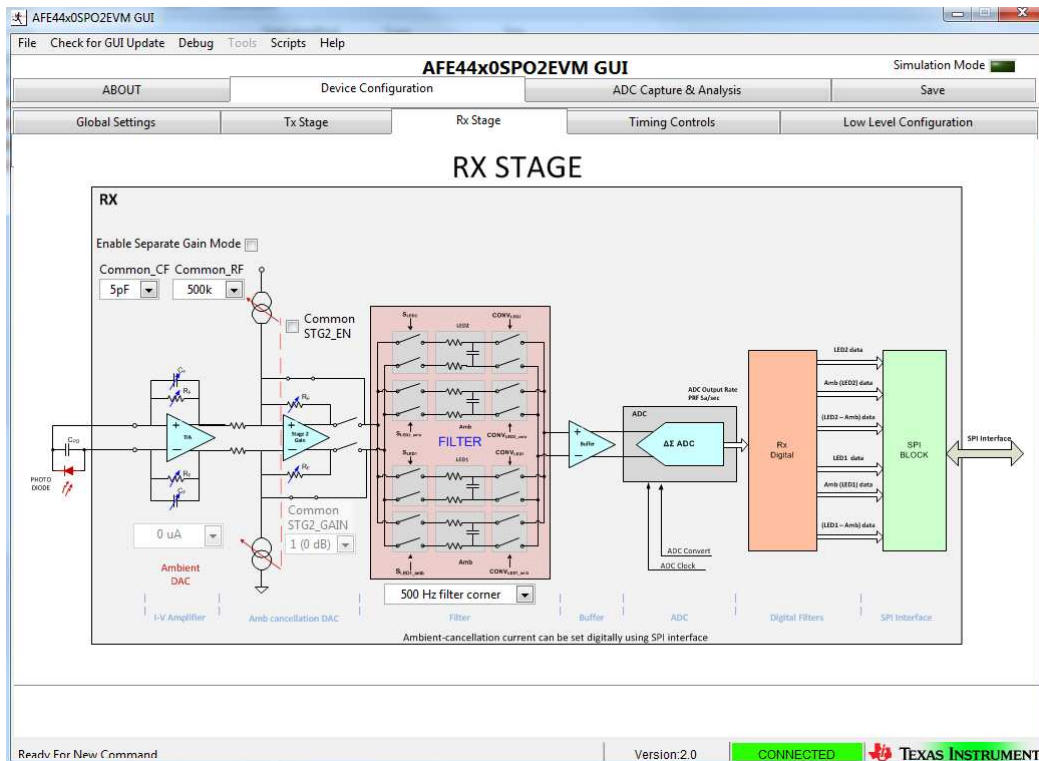

Figure 26. AFE4490: Device Configuration: Rx Stage

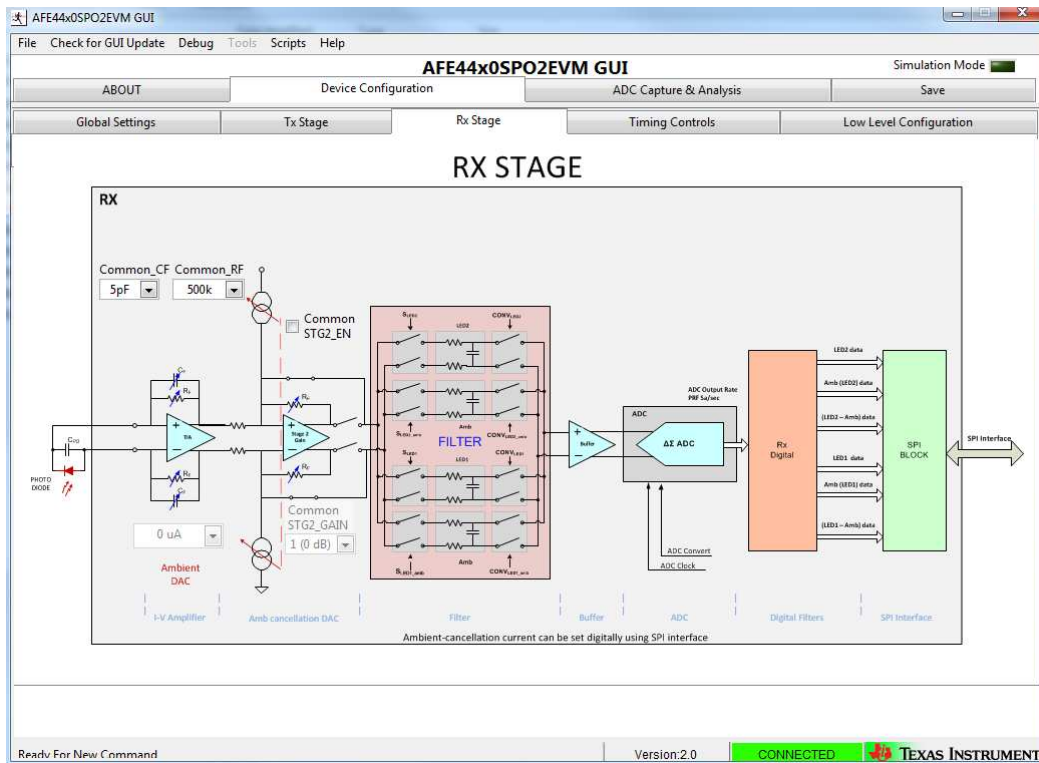

Figure 27. AFE4400: Device Configuration: Rx Stage

#### 4.1.1.4 Timing Controls Subtab

The *Timing Controls* subtab under the *Device Configuration* tab, shown in [Figure 28](#) for AFE4490 and [Figure 29](#) for AFE4400, consists of the following settings:

1. Enter the *Pulse Repetition Frequency* (PRF) and *Duty Cycle %* and click the **SET** button to automatically set the following:
  - (a) LED1 (IR) and LED2 (Red) ON and OFF time,
  - (b) Rx sample start and end time for 4 channels (LED1, LED1 Ambient, LED2, LED2 Ambient)
  - (c) Rx convert start and end time for 4 channels (LED1, LED1 Ambient, LED2, LED2 Ambient)
2. Save the timing settings based on PRF and duty cycle to a configuration file
3. Load the timing settings based on PRF and duty cycle from a configuration file
4. *Timer Enable* selector
5. Timer Counter **RESET** button
6. Set Number of Averages (available for AFE4490 device only)

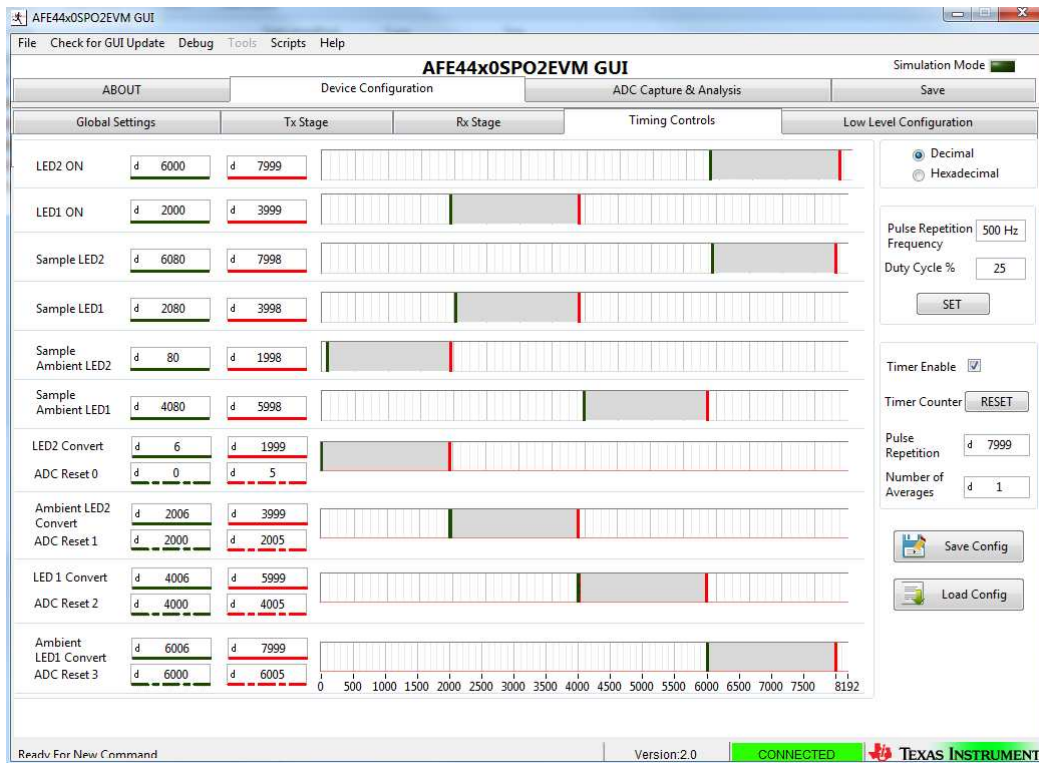

Figure 28. AFE4490: Device Configuration: Timing Controls

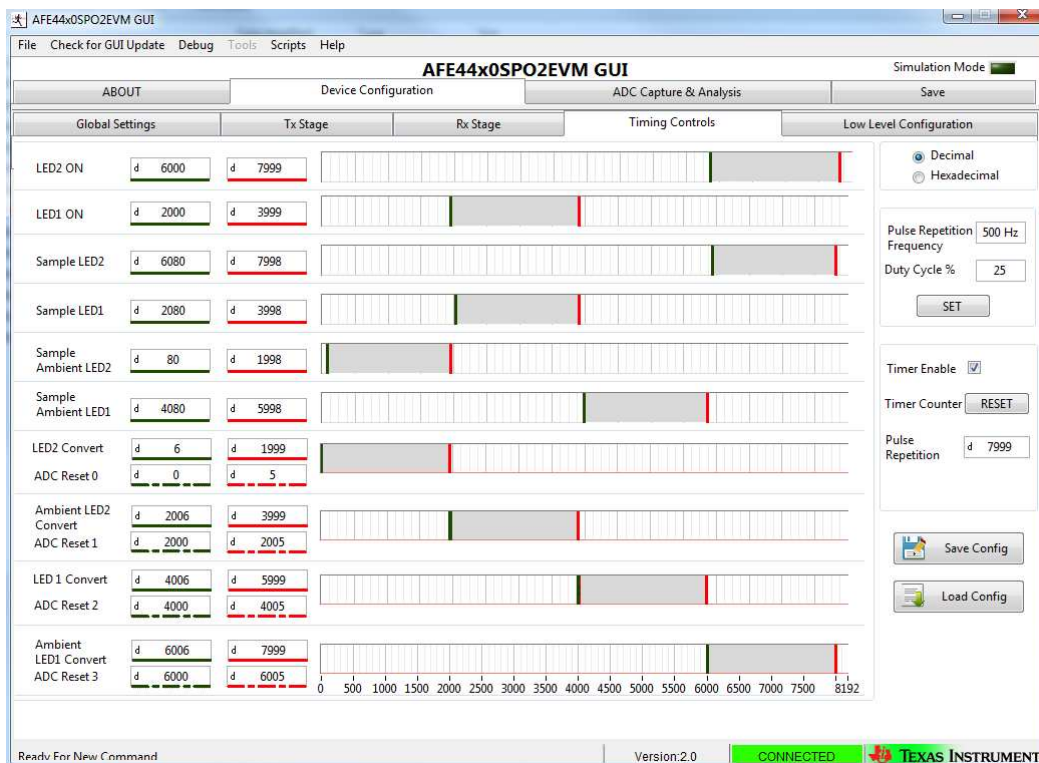

Figure 29. AFE4400: Device Configuration: Timing Controls

### 4.1.1.5 Low Level Configuration Subtab

The *Low Level Configuration* subtab under the *Device Configuration* tab is used to directly configure the various registers of the AFE44x0 devices. Refer to the AFE44x0 data sheet ([SBAS601](#), [SBAS602](#)) for the register details of the chip.

**Figure 30** shows the low-level configuration registers of the AFE44x0 devices. The *Register Map* portion of the sub-tab shows the EVM default values of the registers after the GUI is loaded under the *EVM Default* column. The *LW\** column shows the latest written values of the AFE44x0 register and the *LR\** column shows the latest read values of the AFE44x0 registers. From the *Register Map* section, when any register is selected, the bit-level details about the register are explained in the *Register Description* section. The ability to read and write the register and modify the individual bits of the register are provided in the *Register Data* section. The values of all the registers are read by clicking the **Read All** button.

Click on *Transfer Read to Write* to copy the contents of the Read Data to Write Data. Then click on *Write Register* to write to the data to the register of the AFE44x0.

By clicking on the **Save Config** button, the register configuration is saved to a configuration file. The register configuration is loaded from a configuration file by clicking the **Load Config** button.

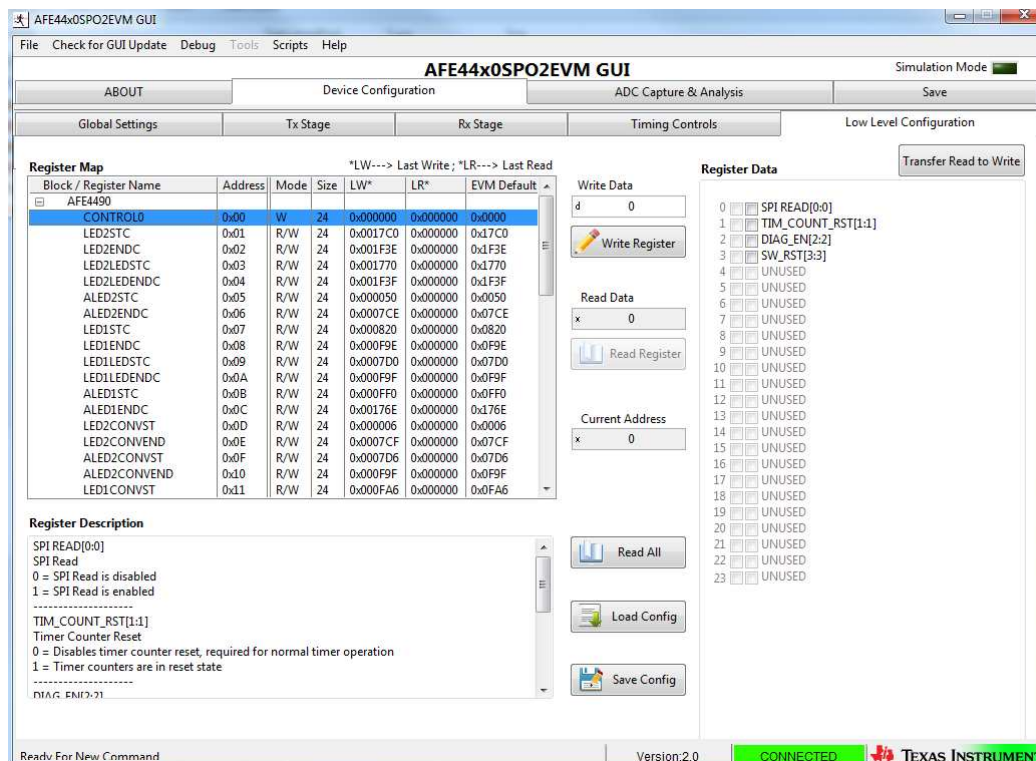

**Figure 30. Device Configuration: Low Level Configuration**

When a selection is made on any of the tabs on the GUI, multiple fields of various registers are modified. Click on the lower-left corner of the GUI to view the registers that are modified when a selection is made.

### 4.1.2 ADC Capture and Analysis

The *ADC Capture and Analysis* tab consists of various analysis routines and displays. This tab is used to:

- Set the capture mode to finite or continuous
- Set the number of samples (block size) in Finite Capture mode
- Set the display to volts or codes
- Set the filter type to None or Notch
- Set the Notch Freq to 50 or 60 Hz when the filter type is set to Notch

- Set Analysis Type to All Domain or Time Domain only
- Auto save after capture selector
- Acquire the data by clicking the **Capture** button
  - When the user selects the auto save after capture selector under 'ADC Capture & Analysis' tab, the GUI uses the settings selected under 'Analysis to Save,' 'Channels to Save,' 'Data to Save,' and 'Save File Settings'. The user will be notified with a 'Results saved successfully!' after every capture.

The captured data can be analyzed in time domain and frequency domain; the data can also be displayed in a histogram format. The ADC Capture and Analysis tab is shown in [Figure 31](#).

By selecting the Time Domain plot, the data are displayed in time domain format. The units can be converted from codes to volts using the drop-down window in the top-left corner of the GUI. For the time domain plot, the mean voltage, root mean square (RMS) voltage, and peak-to-peak voltage are displayed in the *Test Results* section, which is a pop-up window that opens when the **Scope Analysis** button is clicked. The Scope Analysis: Test Results section pop-up window is shown in [Figure 32](#).

By selecting the FFT plot, the data are displayed in the frequency domain by performing an FFT on the channel selected. Details of the FFT (including SNR, THD, and so on) are shown in the Test Results section located in the left side of the GUI.

Selecting the Histogram plot displays the data in a histogram format for the channel selected. The data are arranged in the total number of histogram bins set within the tab following acquisition. The histogram analysis (shown in the *Test Results* section of the GUI) is used to view the mean voltage, root mean square (RMS) voltage, and peak-to-peak voltage.

Four plot modes can be selected: Single Plot mode, Double Plot mode, Three Plot mode and Four Plot mode. In Single Plot mode, only one plot (Time, FFT, or Histogram) can be viewed and analyzed for post processing. In Double Plot mode, any two plots (Time, FFT or Histogram) can be viewed and analyzed. In Three Plot mode, any three plots and in Four Plot mode, any four plots (Time, FFT or Histogram) can be viewed and analyzed.

The following algorithms have been used to find the # of samples for FFT calculation:

- (a) # of samples for FFT calc. which is power of 2  $\leq \min ( (\text{Data rate (sps)} \times N \text{ where } N \text{ is the value in the "Show data for the last } N \text{ secs" column}) , \text{No. of samples} )$
- (b) If ( (# of samples for FFT calc. == No. of samples) && (Filter Type == "None") ) then # of samples for FFT calc. = No. of samples
- (c) If ( (# of samples for FFT calc. == No. of samples) && (Filter Type == "Notch") ) then # of samples for FFT calc. = No. of samples / 2. This is to allow for filter settling.
- (d) If ( # of samples for FFT calc. < 32 samples ) then an error msg "Insufficient # of samples for FFT calculation" will be displayed.

#### Examples:

1. No. of samples = 8192  
 Data rate (sps) = 500  
 Show data for the last 5 secs  
 Then # of samples for FFT calc. which is power of 2 =  $2048 \leq \min ( (500 \times 5) , 8192 )$
2. No. of samples = 8192  
 Data rate (sps) = 500  
 Show data for the last 8 secs  
 Then # of samples for FFT calc. which is power of 2 =  $2048 \leq \min ( (500 \times 8) , 8192 )$
3. No. of samples = 8192  
 Data rate (sps) = 500  
 Show data for the last 20 secs  
 # of samples for FFT which is power of 2 =  $8192 \leq \min ( (500 \times 20) , 8192 )$   
 Since (# of samples for FFT calc. == No. of samples) and if (Filter Type = None) then # of samples for FFT which is power of 2 = 8192  
 Since (# of samples for FFT calc. == No. of samples) and if (Filter Type = Notch) then # of samples for FFT which is power of 2 =  $8192 / 2$



4. No. of samples = 30  
 Data rate (sps) = 500  
 Show data for the last 1 secs  
 Then display Error message “Insufficient # of samples for FFT calculation” since # of samples for FFT which is power of 2 =  $16 \leq \min(500 \times 1, 30)$
5. No. of samples = 32  
 Data rate (sps) = 500  
 Show data for the last 2 secs  
 # of samples for FFT which is power of 2 =  $32 \leq \min(500 \times 2, 32)$   
 Since (# of samples for FFT calc. == No. of samples) and If (Filter Type = None) then # of samples for FFT calc. which is power of 2 = 32  
 Since (# of samples for FFT calc. == No. of samples) and If (Filter Type = Notch) then an error msg “Insufficient # of samples for FFT calculation” will be displayed since # of samples for FFT calc. which is power of 2 =  $(32 / 2) < 32$  samples

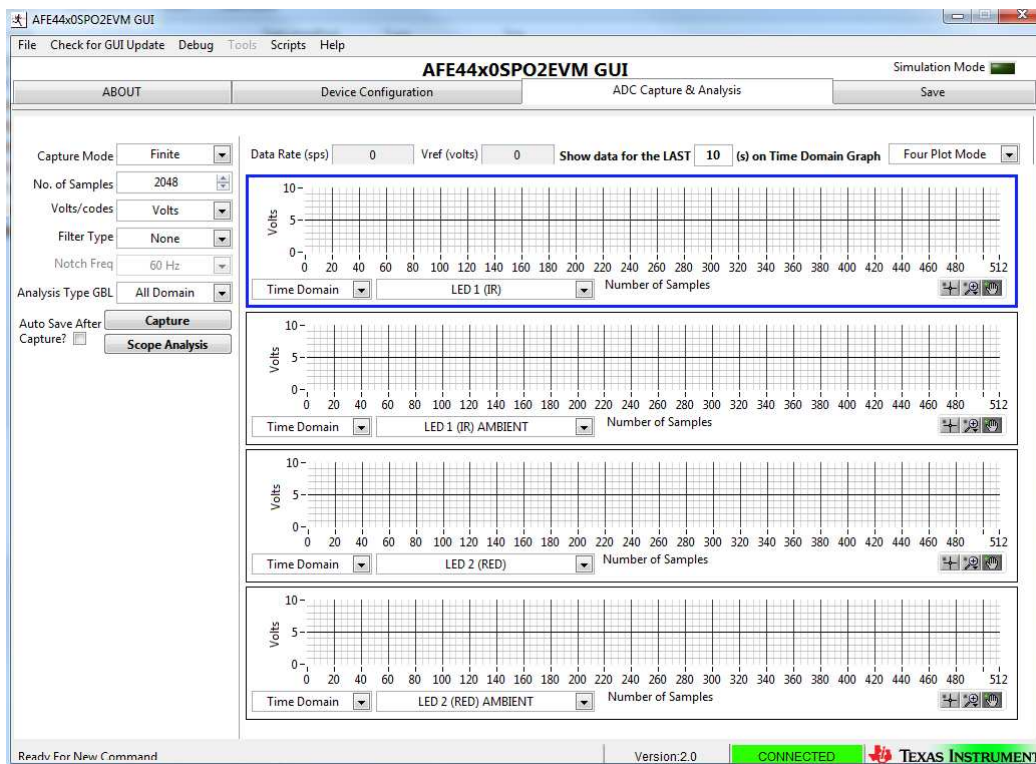

Figure 31. ADC Capture and Analysis Tab

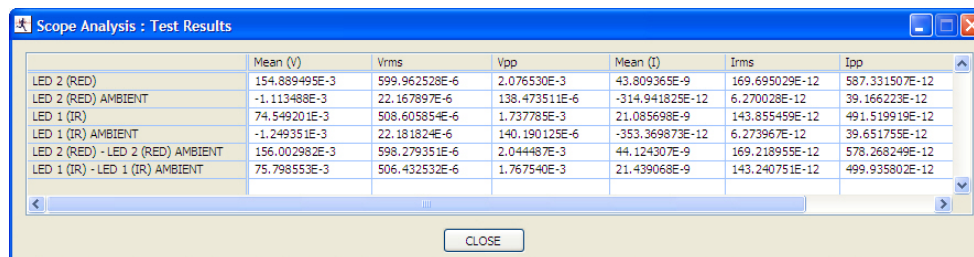

Figure 32. Scope Analysis: Test Results

### 4.1.3 Save Tab

The Save tab shown in [Figure 33](#) provides provisions to save the analysis or data to a file. By default, the data are saved to the following location:

- On a Windows XP machine
  - C:\Program Files\Texas Instruments\AFE44x0SPO2EVM GUI\Log
- On a Windows 7 or Windows 8 machine
  - C:\Program Files(x86)\Texas Instruments\AFE44x0SPO2EVM GUI\Log

Use the *Directory to Save Files* option to select the folder where data are to be saved. In the pop-up window, navigate to the folder where the data file is to be saved and select *Use Current Folder*. Then select *Save to File* to save the file.

When the user selects the auto save after capture selector under 'ADC Capture & Analysis' tab, the GUI uses the settings selected under 'Analysis to Save,' 'Channels to Save,' 'Data to Save,' and 'Save File Settings'. The user will be notified with a 'Results saved successfully!' after every capture.

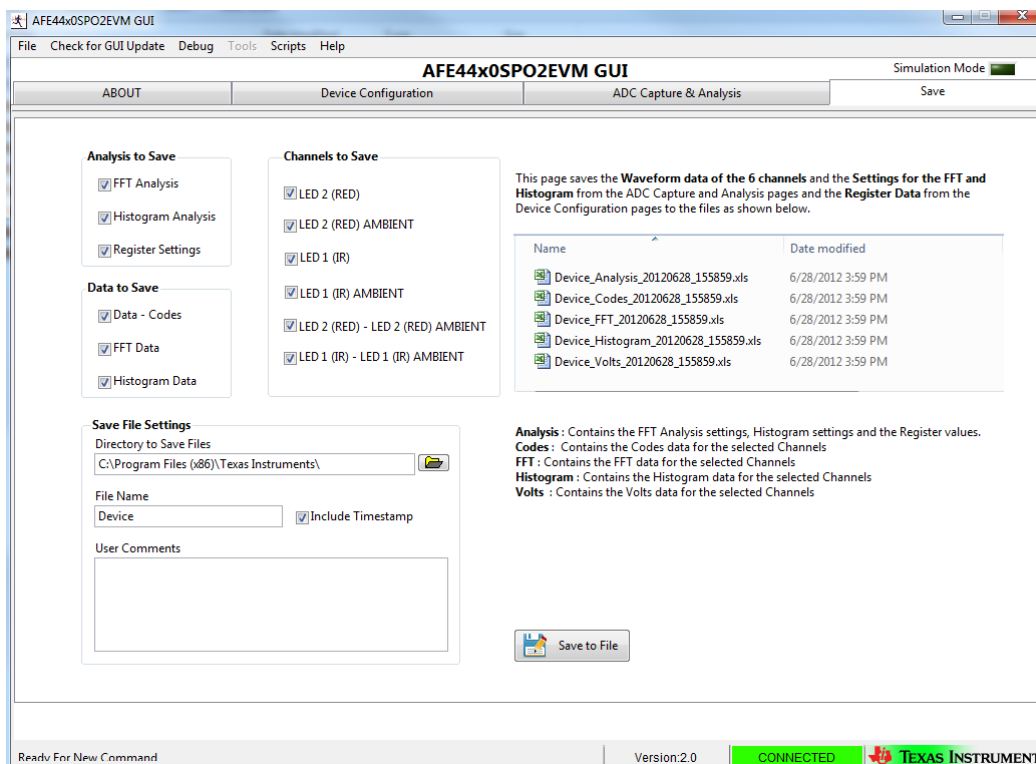

Figure 33. Save Tab

Table 1 contains the Save tab control descriptions.

**Table 1. Save Tab Control Descriptions**

Button/Control	Description
Scope Analysis	Saves the scope analysis result. The result is saved in the file <i>Device_&lt;record number&gt;_Analysis.xls</i> .
FFT Analysis	Saves the FFT analysis result. The result is saved in the file <i>Device_&lt;record number&gt;_Analysis.xls</i> .
Histogram Analysis	Saves the histogram analysis result. The result is saved in the file <i>Device_&lt;record number&gt;_Analysis.xls</i> .
Register Settings	All the current register values are read from the EVM and stored. The result is saved in the file <i>Device_&lt;record number&gt;_Analysis.xls</i> .
Data – Codes	Acquired data sample values are stored to the file <i>Device_&lt;record number&gt;_Codes.xls</i> .
FFT Data	Acquired data sample's FFT values are stored to the file <i>Device_&lt;record number&gt;_FFT.xls</i> .
Histogram Data	Acquired data sample's histogram values are stored to the file <i>Device_&lt;record number&gt;_Histogram.xls</i> .

The *Record Number* saves files with the provided number in the file name. User notes can also be added to the file by typing the notes in the *User Comments* control.

## 5 AFE44x0SPO2EVM Hardware

### CAUTION

Many of the components on the AFE44x0SPO2EVM are susceptible to damage by electrostatic discharge (ESD). Customers are advised to observe proper ESD handling precautions when unpacking and handling the EVM, including the use of a grounded wrist strap, bootstraps, or mats at an approved ESD workstation. Safety glasses should also be worn.

The key features of the AFE44x0 Analog Front End demonstration board are:

- Based on MSP430F5529
- DB9 pulse oximeter sensor cable support
- Acquire data at up to 3000 Hz in evaluation mode
- SPI Data interface

The AFE44x0SPO2EVM board can be used as a demo board for pulse oximeter and heart rate applications. The BOM is provided in [Section 11](#). The printed circuit board (PCB) and schematic are shown in [Section 12.1](#) and [Section 12.2](#), respectively.

MSP430F5529 (U2 – see [Section 12.2](#)) is the microcontroller used on the board. For more details of the MSP430F5529 please visit <http://focus.ti.com/docs/prod/folders/print/msp430f5529.html>

The following sections explain the main hardware components available on the EVM. [Figure 34](#) shows the functional block diagram for the EVM.

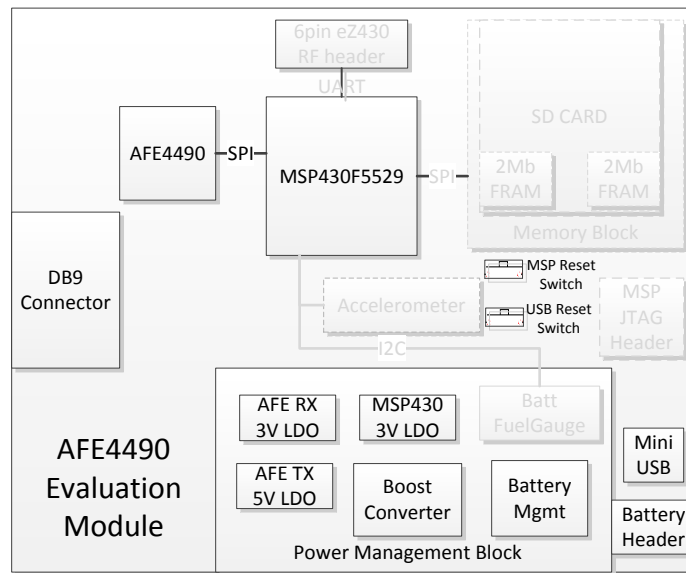

a. AFE4490 Evaluation Module

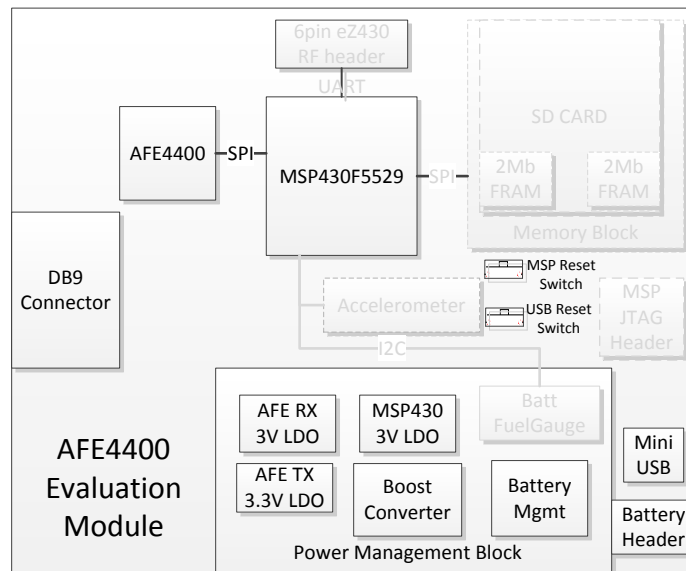

b. AFE4400 Evaluation Module

**Figure 34. AFE44x0SPO2EVM Block Diagram**

## 5.1 Power Supply

AFE4490 can operate from 2.0- to 3.6-V Rx analog supply (RX\_ANA\_SUP), 2.0- to 3.6-V Rx digital supply (RX\_DIG\_SUP), 3.0- to 5.25-V Tx Control supply (TX\_CTRL\_SUP) and LED driver supply (LED\_DRV\_SUP).

AFE4400 can operate from 2.0- to 3.6-V Rx analog supply (RX\_ANA\_SUP), 2.0- to 3.6-V Rx digital supply (RX\_DIG\_SUP), 3.0- to 3.6-V Tx Control supply (TX\_CTRL\_SUP) and LED driver supply (LED\_DRV\_SUP).

The power for the board is derived from the USB input (J4) through a forward-biased diode (D5) to avoid reverse current flow. The USB data bus is ESD protected using TI's ESD protection diode array TPD4E004DRYR (U7). The USB VBUS is fed to the integrated Li-ion linear charger and system power-path management module, BQ24032ARHLR (U12), which generates greater than 4.2-V output (VCC\_BAT). This output is fed to TI's low-input boost converter with integrated power diode and input/output isolation, TPS61093 (U9), for generating a boosted voltage of 8.97 V. This output is fed to low-noise voltage regulator LP3878-ADJ (U8) for generating 5 V for the LED\_DRV\_SUP and TX\_CTRL\_SUP for AFE4490 EVM and for generating 3.3 V for the LED\_DRV\_SUP and TX\_CTRL\_SUP for AFE4400 EVM. The boost converter output is also fed to the ultralow-noise linear voltage regulator TPS7A4901DGN (U13) for generating 3 V for the RX\_ANA\_SUP and RX\_DIG\_SUP. The boost converter output is also fed to the ultralow-noise linear voltage regulator TPS7A4901DGN (U14) for generating 3 V for MSP\_DVCC and MSP\_AVCC.

The inductors L2, L2, L4, and L5 are used to minimize the power supply noise induced by the power supply regulators.

Test point and series jumper resistors are provided to make sure the power supplies to the board are correct. The corresponding voltages on AFE4490SPO2EVM are given in [Table 2](#). The corresponding voltages on AFE4400SPO2EVM are shown in [Table 3](#).

**Table 2. Test Points for Measuring Voltages on the AFE4490SPO2EVM**

S. No.	Test Point	Description
1	TP36	5 V
2	L6, pin # 2 (R76)	5 V
3	L5, pin # 2 (R65)	5 V
4	L1, pin # 2 (R55)	3 V
5	L2, pin # 2 (R54)	3 V
6	L3, pin # 2	3 V

**Table 3. Test Points for Measuring Voltages on the AFE4400SPO2EVM**

S. No.	Test Point	Description
1	TP36	5 V
2	L6, pin # 2 (R76)	3.3 V
3	L5, pin # 2 (R65)	3.3 V
4	L1, pin # 2 (R55)	3 V
5	L2, pin # 2 (R54)	3 V
6	L3, pin # 2	3 V

## 5.2 Clock

The EVM has the option to use the on-board 8-MHz crystal or the clock for the AFE44x0 from the MSP430. The EVM is shipped to use the on-board 8-MHz crystal. The 4-MHz buffered output clock from the AFE44x0 can be accessed through the series jumper resistor, R23.

### 5.3 Accessing AFE44x0 Digital Signals

AFE44x0 SPI interface and other digital signals with MSP430 can be accessed through the series resistor jumpers given in [Table 4](#).

**Table 4. AFE44x0 Digital Signals**

S. No.	Signal	Jumper Resistor
1	STE	R29
2	SIMO	R31
3	SOMI	R33
4	SCLK	R35
5	ADC_RDY	R26
6	PD_ALM	R37
7	LED_ALM	R39
8	DIAG_END	R38
9	AFE_PDNZ	R42

### 5.4 Analog Inputs

The AFE44x0SPO2EVM gives the user the option to feed in the pulse oximeter simulator signals to the DB9 connector (J2).

For all measurements in this user guide, the ProSim Fluke SPOT Light SpO2 Functional tester was used as shown in [Figure 35](#).



**Figure 35. Fluke SPOT Light SpO2 Functional Tester Setup**

### 5.5 USB Interface

The EVM has a mini USB interface for PC application connectivity requiring a standard mini USB to USB cable for connection. AFE44x0SPO2EVM is designed to work in the slave mode.

### 5.6 On-Board Key Interface

The EVM has 2 switches. The function of each switch is defined in [Table 5](#)

**Table 5. AFE44x0SPO2EVM Switches**

Switch Number	Description
SW1	This switch is used for hard reset of the board. The board resets and starts again with the firmware loaded.
SW2	This switch is used to enable boot strap loader (BSL) MSP430 firmware.

## 5.7 Visual Indication

The blue LED (LED3) indicates the USB power connection. The blue LED (LED1) indicates that the microcontroller is busy servicing the requests from the PC application.

## 6 USB-Based Firmware Upgrade

**NOTE:** AFE44x0SPO2EVM GUI v2.0 works with FW rev 1.3. Follow the steps outlined in this section to upgrade the firmware to rev 1.3.

The firmware on the AFE44x0SPO2EVM can be changed from the PC application by selecting the *Firmware Upgrade* menu option on the PC application. At the end of the firmware upgrade, the system issues a reset command and reloads with new firmware. The firmware upgrade process steps are represented in the screen shots below:

- From the PC application, click on *File* → *Firmware Upgrade*.
- A pop-up window opens up as shown in [Figure 36](#). Follow the instructions to continue to Firmware Upgrade or to cancel the operation.

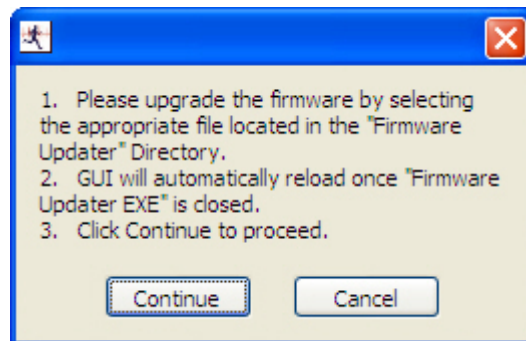

**Figure 36. PC Application Firmware Upgrade – 1**

- The firmware upgrade application detects the connected EVM ([Figure 37](#)).

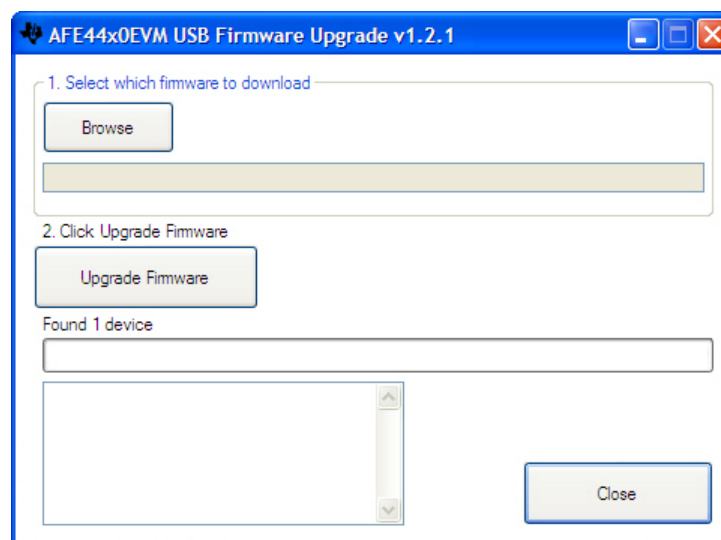

**Figure 37. PC Application Firmware Upgrade – 2**

- Visually inspect the EVM and find out the device installed on the EVM. The EVM supports two devices AFE4400 and AFE4490. Browse and select the appropriate firmware binary file (example: AFE4490\_EVM\_FW\_V1.3.txt file) and click *Upgrade Firmware* as shown in [Figure 38](#). The default firmware is available from:

- On a Windows XP machine:
  - C:\Program Files\Texas Instruments\AFE44x0SPO2EVM GUI\Firmware Updater
- On a Windows 7 or Windows 8 machine:
  - C:\Program Files(x86)\Texas Instruments\AFE44x0SPO2EVM GUI\Firmware Updater

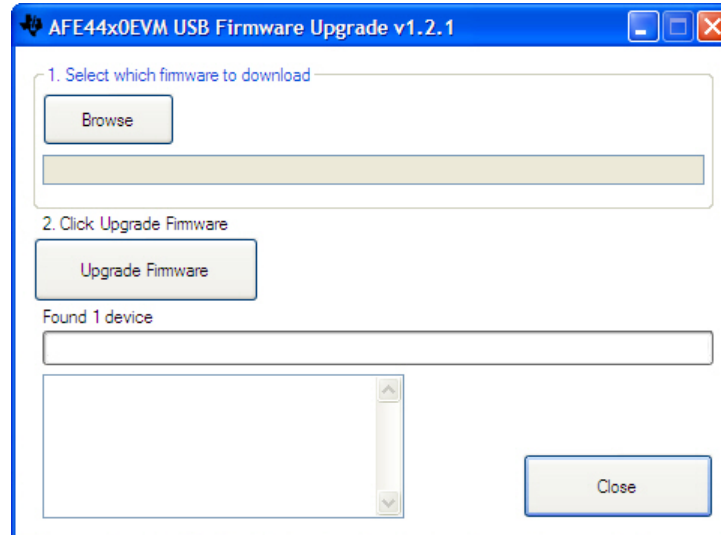

**Figure 38. PC Application Firmware Upgrade – 3**

- Once the device is programmed successfully, as shown in [Figure 39](#), the device resets and reloads with the new firmware. Close the *Firmware Upgrade* application by clicking on the **Close** button and the PC GUI application automatically restarts the GUI after 4 to 5 seconds.

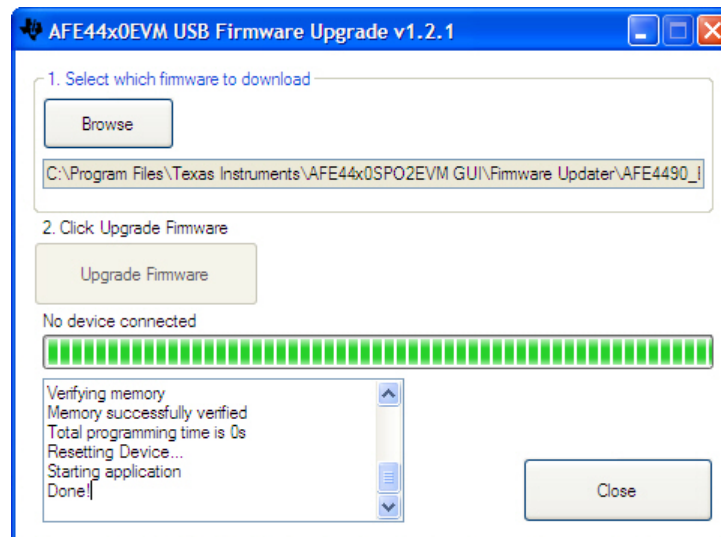
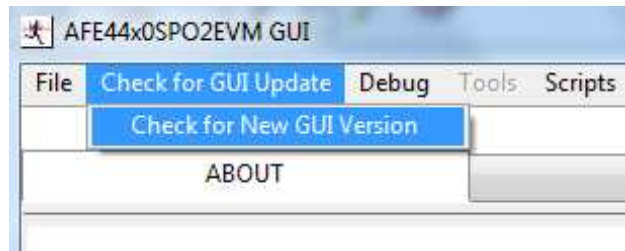

**Figure 39. PC Application Firmware Upgrade – 4**



## 7 GUI Update

The user can check for the latest version of the GUI by selecting 'Check for New GUI Version' from the menu options on the PC application as shown in [Figure 40](#).

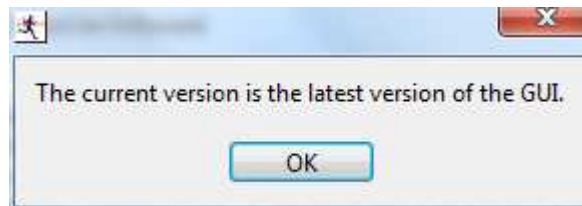

**Figure 40. Check for New GUI Version**

When a newer version of the GUI is available, a pop-up message will appear letting the user to download the update now or at a later time. The latest version of the GUI will be downloaded to the following directory:

- On a Windows XP machine:
  - C:\Program Files\Texas Instruments\AFE44x0SPO2EVM GUI
- On a Windows 7 or Windows 8 machine:
  - C:\Program Files(x86)\Texas Instruments\AFE44x0SPO2EVM GUI

If a newer version is not available, a pop-up message will let the user know that the current version is the latest version of the GUI as shown in [Figure 41](#).



**Figure 41. Current GUI Version is the Latest Version**

## 8 Connector Interface

The following connectors are used for external interface to the AFE44x0 Pulse Oximeter board.

- DB9
- USB mini connector

### 8.1 DB9 Pulse Oximeter Connector

The DB9 pulse oximeter connector pinouts are shown in [Figure 42](#). The description of the pinouts is provided in [Table 6](#)

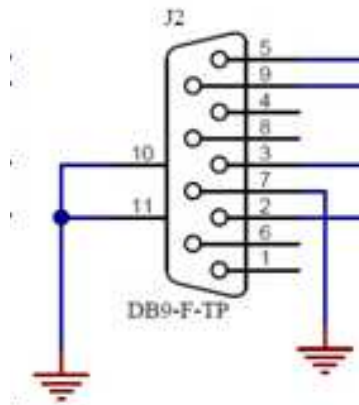

Figure 42. DB9 Pulse Oximeter Connector Pinouts

Table 6. DB9-Based Pulse Oximeter Connector Pinouts

Pin Number	Pin Name	Pin Description
2	TX_LED_P	Anode of the LED1 (IR LED), cathode of the LED2 (red LED)
3	TX_LED_N	Cathode of the LED1 (IR LED), anode of the LED2 (red LED)
5	DET_N	Phototransistor anode
7	GND	Cable shield
9	DET_P	Phototransistor cathode

### 8.2 Mini USB Connector

The USB mini connector pinouts are shown in [Figure 43](#). The description of the pinouts is provided in [Table 7](#).

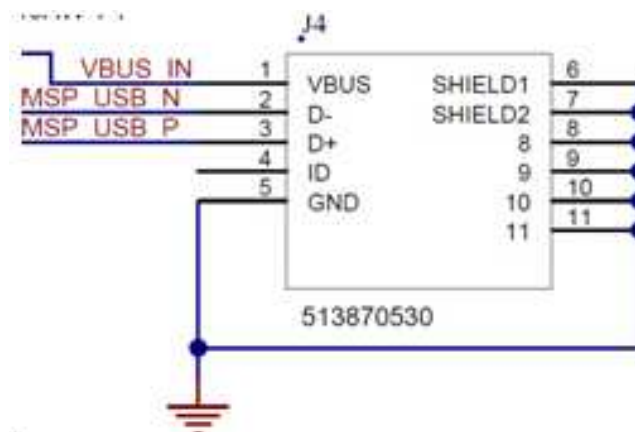

Figure 43. USB Mini Connector Pinouts

**Table 7. USB Mini Connector Pinouts**

Pin Number	Pin Name	Pin Description
1	VBUS	USB power 5 V
2	D-	USB DM
3	D+	USB DP
4	ID	NC
5	GND	GND

## 9 Quick Start Guide

**NOTE:** For all the measurements shown in the following, ProSim Fluke SPOT Light SpO2 Functional tester was used.

- Install the AFE44x0SPO2EVM GUI PC Software (Check the TI website at [www.ti.com](http://www.ti.com) for the latest software) by running the setup file and following the instructions on the screen
- Connect the USB cable to the computer and plug in the mini USB interface cable to the J4 mini USB connector on the EVM
- Connect the DB9 connector of the finger sensor pulse oximeter cable to the J2 connector of the EVM.
- Turn on the Fluke simulator by pressing the ON switch for at least 3 seconds, and then connect the Fluke simulator to the finger sensor. Leave the default setting of 97% for SpO2, 80 bpm for HR, and 2% for PA. [Figure 35](#) shows the Fluke SPOT Light Pulse SpO2 Functional Tester setup with the finger sensor pulse oximeter cable.
- Open the AFE44x0SPO2EVM GUI software by clicking on *Start*→*All Programs*→*Texas Instruments*→*AFE44x0SPO2EVM GUI*.
- Click the *ADC Capture & Analysis* tab and set the following:
  - Capture Mode to *Finite*
  - No. of Samples to 2048
  - Volts/Codes to *Volts*
  - Plot Mode to *Four Plot Mode*
  - Select the first waveform to LED1 (IR)
  - Select the second waveform to LED1 (IR) AMBIENT
  - Select the third waveform to LED2 (Red)
  - Select the fourth waveform to LED2 (Red) AMBIENT
  - Click *Capture*
- [Figure 44](#) shows a sample data capture

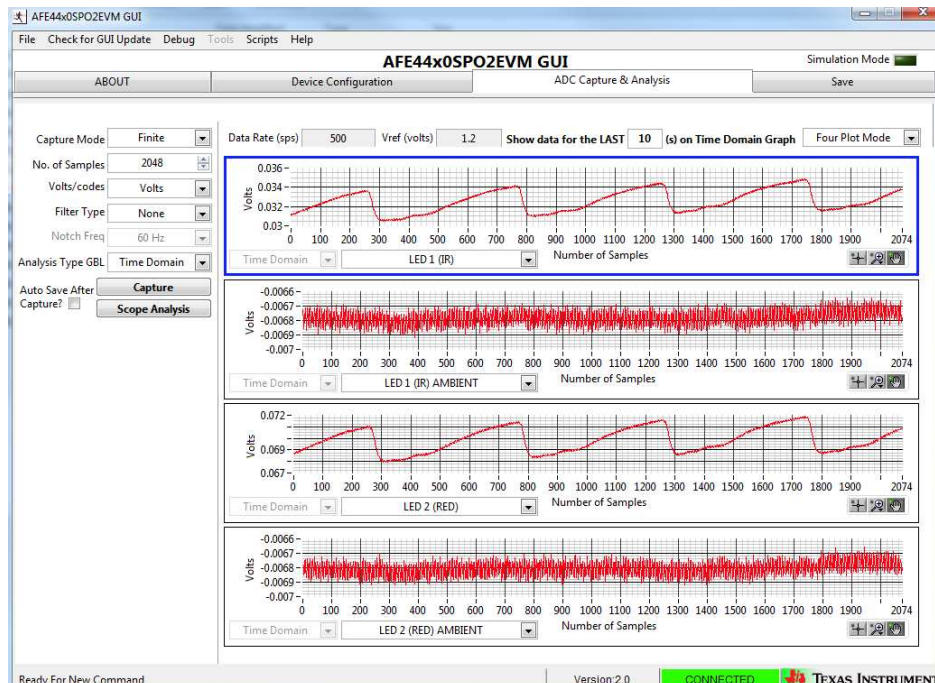

**Figure 44. Sample Test Data**

## 10 AFE44x0SPO2EVM FAQs

### 10.1 EVM Communicating With the PC Application

#### CAUTION

AFE44x0SPO2EVM GUI v.2.0 works with FW revision 1.3. Follow the steps outlined in [Section 6](#) to upgrade the firmware to revision 1.3.

A quick and simple check to verify serial register write operation is to put the AFE44x0 in power-down mode. Follow the sequence to check if the GUI is communicating with the EVM.

- In *Device Configuration* → *Global Settings* tab, select *Powerdown\_AFE*
- This powers down the AFE and the VCM output voltage of the AFE drops to 0 V
- VCM is measured at the VCM\_AFE serial jumper resistor R28 on the board

### 10.2 ADC\_RDY Signal

After executing the GUI, observe the ADC\_RDY waveform at series jumper resistor R26. This should be at the same frequency as the PRF. [Figure 45](#) shows the ADC\_RDY waveform at 500-Hz PRF.

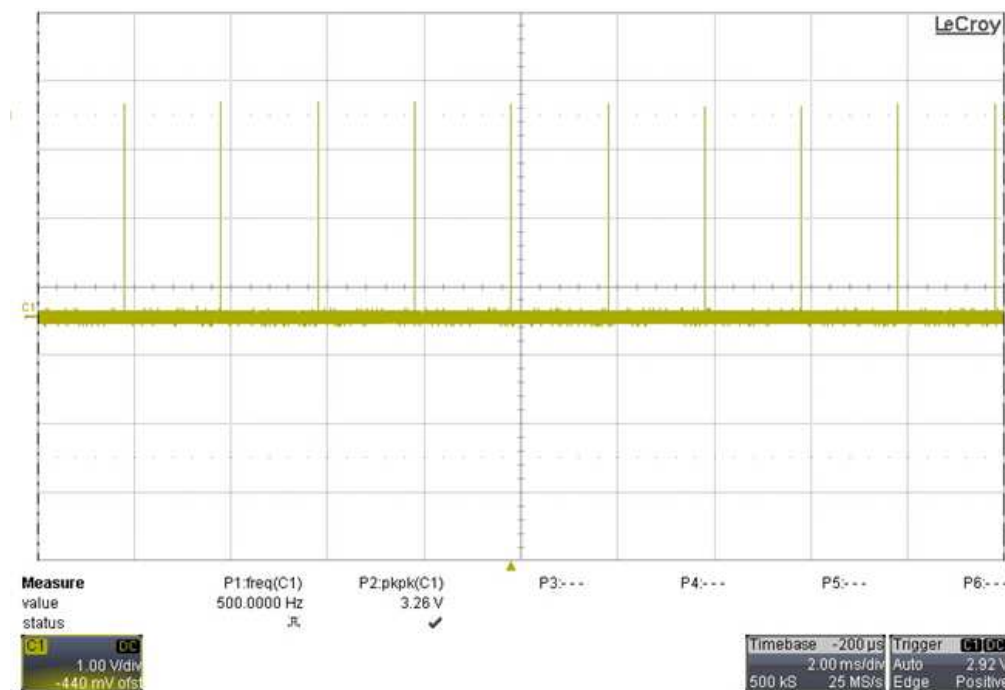

Figure 45. ADC\_RDY Waveform at 500-Hz PRF

### 10.3 Check TXP and TXM Waveforms

TXP and TXM waveforms are observed at TX\_P (TP23) and TX\_N (TP17). [Figure 46](#) shows TXP and TXM waveforms without connecting the pulse oximeter cable. [Figure 47](#) shows TXP and TXM waveforms after connecting the pulse oximeter cable.

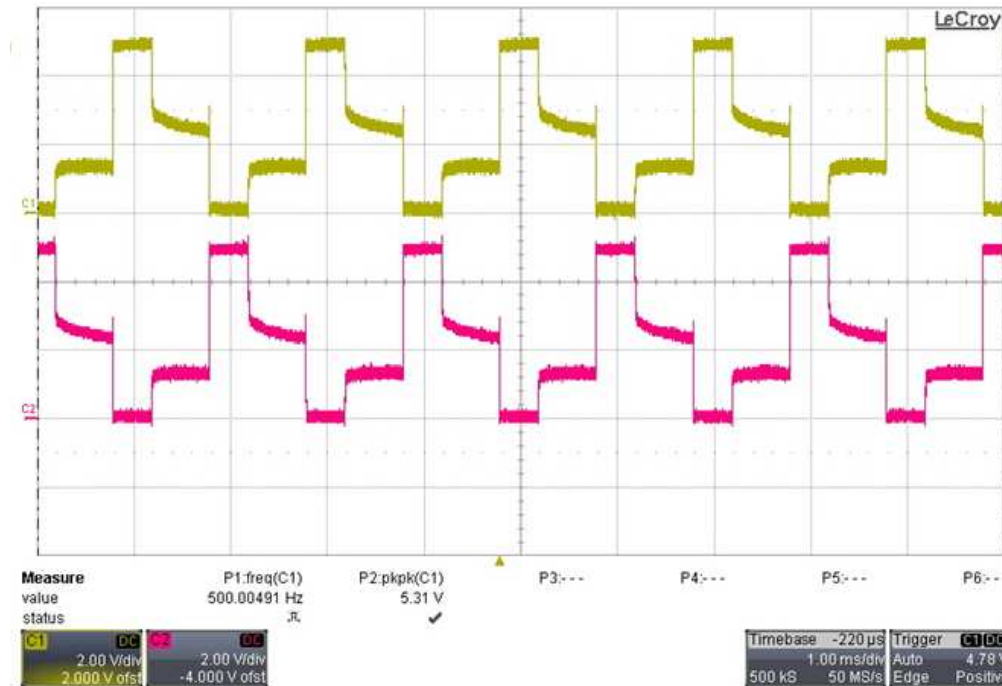

Figure 46. TXP and TXM Without Pulse Oximeter Cable

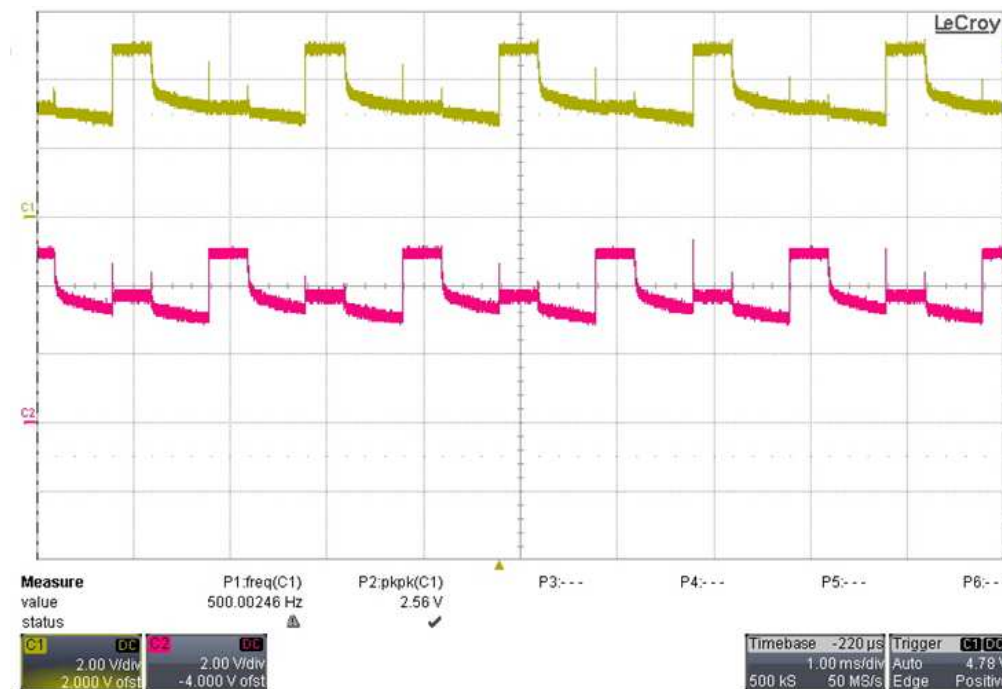

Figure 47. TXP and TXM After Connecting the Pulse Oximeter Cable

### 10.4 Using an External ADC (Bypass ADC Mode) (Available Only for AFE4490 Device)

AFE4490 has a mode where the front-end analog output voltage becomes available on two pins (RX\_OUTP, RX\_OUTN), around a common-mode voltage of about 0.9 V. In this mode, the internal ADC of AFE4490 is disabled, one of the internal ADC\_RESET clocks is brought out on the PD\_ALM pin (PD\_ALM is monitored at series jumper resistor R37). This signal is used to convert each of the four phases (with every pulse repetition period). Additionally the ADC\_RDY signal (ADC\_RDY is monitored at series jumper resistor R26) is used to synchronize the external ADC with the AFE.

### 10.5 Diagnostics

The device includes diagnostics to detect open or short conditions of the LED and photo-sensor, LED current profile feedback, and cable on or off detection. The EVM supports the diagnostic feature of the device.

The diagnostic feature is enabled from the *Global Settings* under the *Device Configuration* tab. Clicking the **Diagnostic Enable** button enables the diagnostic function and once the diagnostic function is completed, the status of the fault flags are updated on the *Global Settings* tab. [Figure 48](#) shows the diagnostic mode fault flags when no finger pulse oximeter sensor was connected to the EVM.

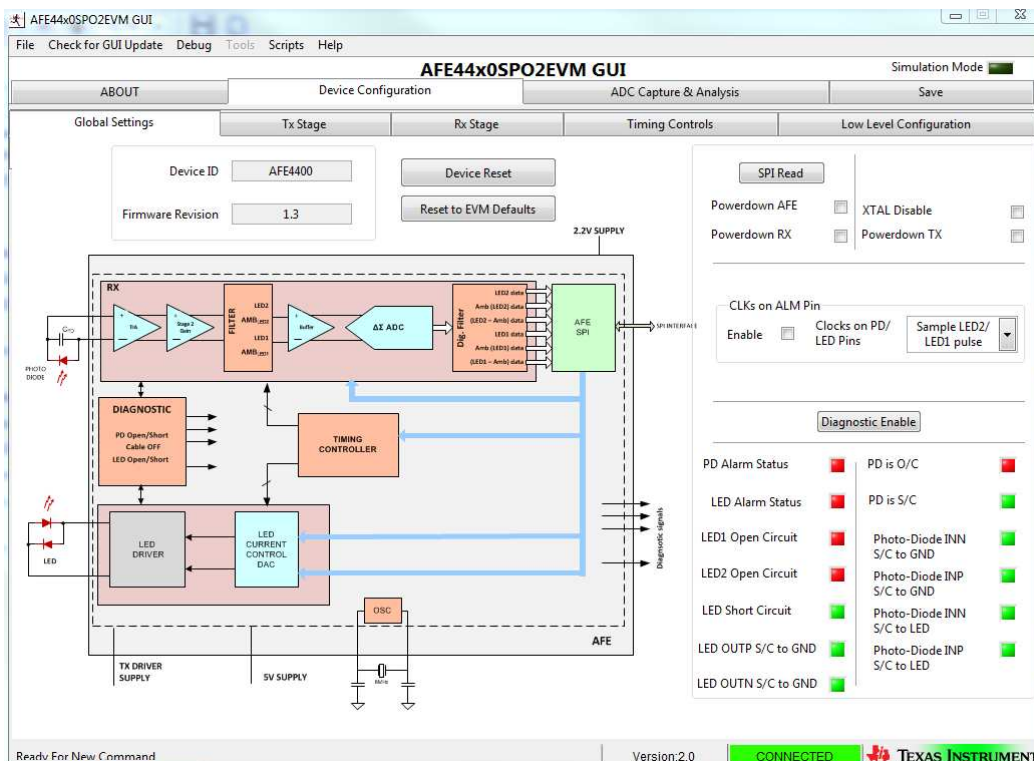

Figure 48. Diagnostic Feature Fault Flags With No Finger Sensor Connected to the EVM

### 10.6 Automation of Register Read and Write Operations

Refer to the Scripting document located in the Documentation directory for detailed instruction on how to use automation functions for register read and write operations.

Documentation directory is located at the following location:

- On a Windows XP machine – C:\Program Files\Texas Instruments\AFE44x0SPO2EVM GUI\Documentation
- On a Windows 7 or Windows 8 machine – C:\Program Files(x86)\Texas Instruments\AFE44x0SPO2EVM GUI\Documentation

### 10.7 Optimum Viewing Experience on Windows 7 OS

- Change the size of text to Smaller – 100% for optimum viewing experience on Windows 7 operating system as shown in [Figure 49](#).

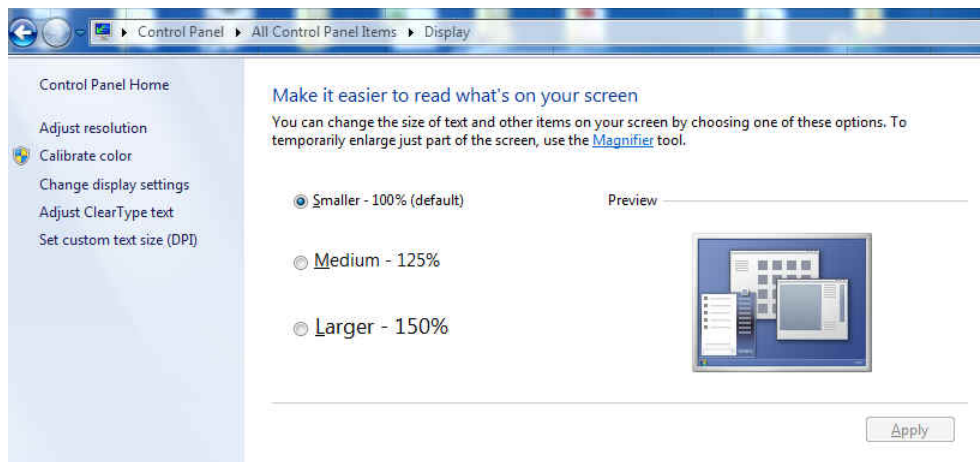

**Figure 49. Setting Font Size on Windows 7 Operating System**

### 10.8 Windows 8 Support for Device GUIs

At GUI Start up, sometimes the GUI might show a broken arrow as seen in [Figure 50](#). One of the reasons for this issue may be due to a missing update of .NET FRAMEWORK 3.5 (includes .NET 2.0 and .NET 3.0).

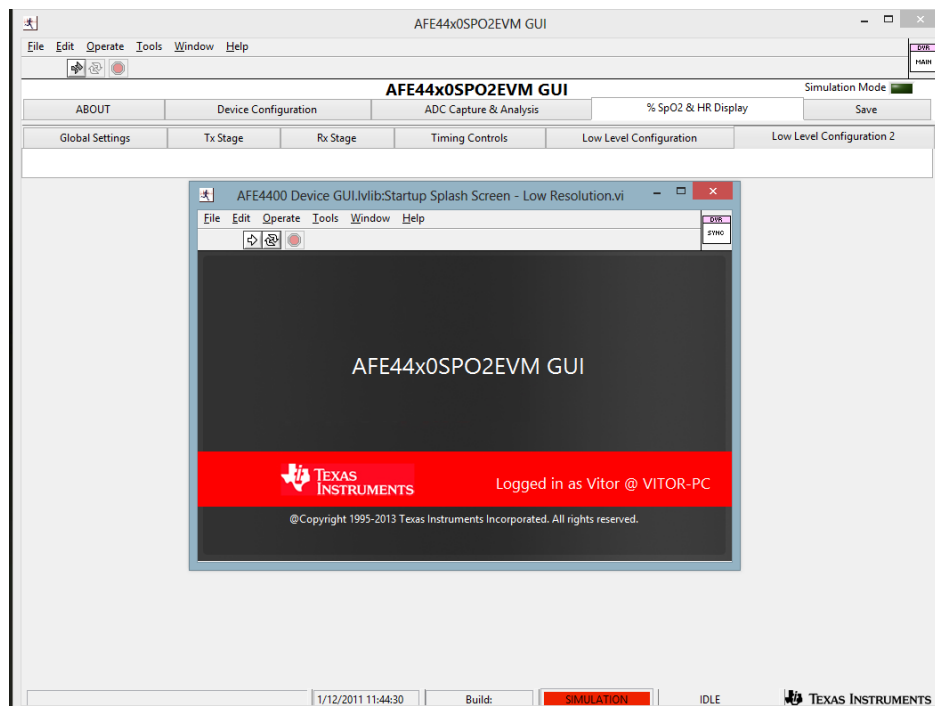

**Figure 50.**

The .NET FRAMEWORK 3.5 is needed for the GUI to:

- Check if Python is Installed
- Checking and setting environment variables needed for the scripting feature in the GUI



Points to Remember:

- There is no download for the .NET Framework 3.5 for Windows 8 or Windows 8.1. The user must enable the .NET Framework 3.5 in Control Panel by following the instructions provided in this article.
- Use the .NET Framework 3.5 for apps built for versions 2.0 and 3.0 as well as 3.5.
- Installing a Windows language pack before installing the .NET Framework 3.5 will cause the .NET Framework 3.5 installation to fail. Install the .NET Framework 3.5 before installing any Windows language packs. (Source: [http://msdn.microsoft.com/library/hh506443\(v=VS.110\).aspx](http://msdn.microsoft.com/library/hh506443(v=VS.110).aspx))

There are two methods to resolve this.

**10.8.1 Method 1 (Enabling the .NET Framework 3.5 in Control Panel)**

In Control Panel, choose Programs and Features, choose Turn Windows features on or off, and then select the .NET Framework 3.5 (includes .NET 2.0 and 3.0) check box. This option requires an Internet connection. The user does not need to select the child items.

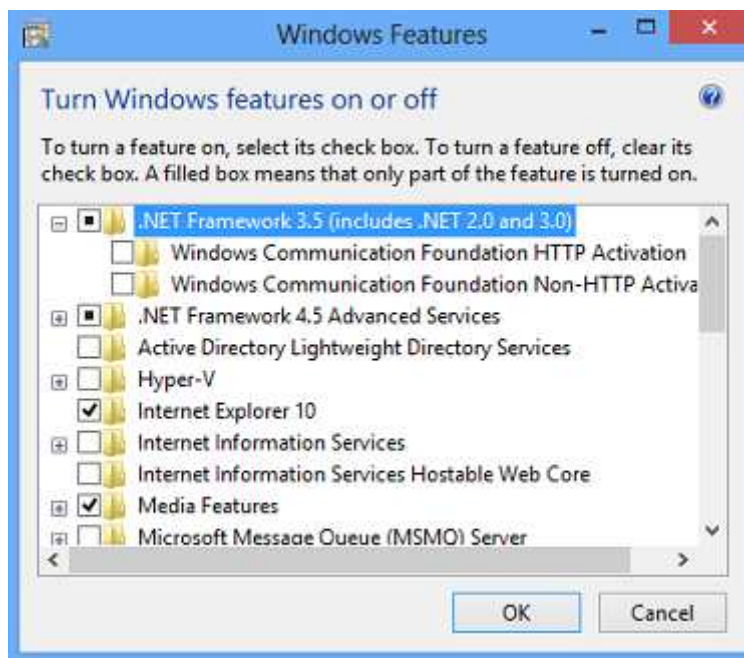
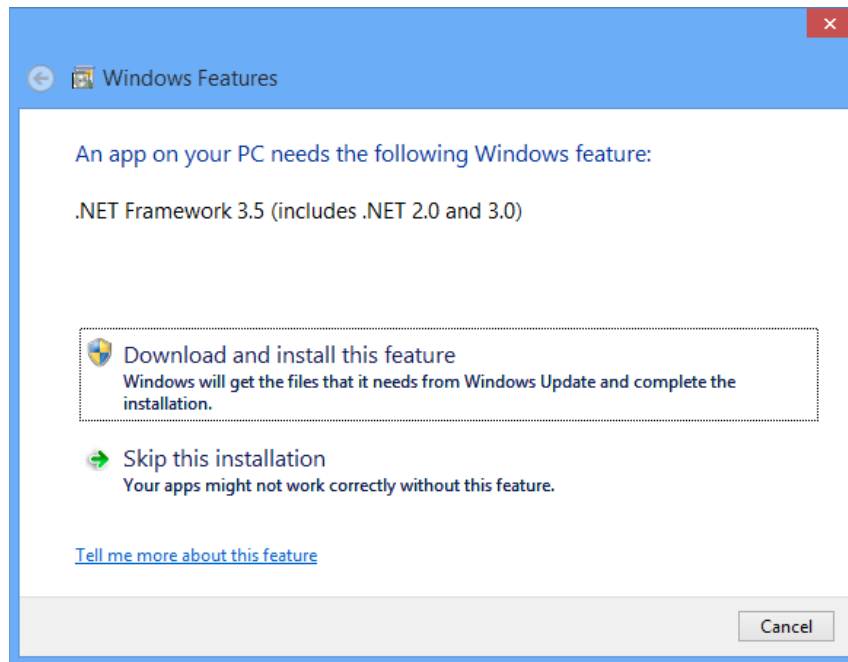
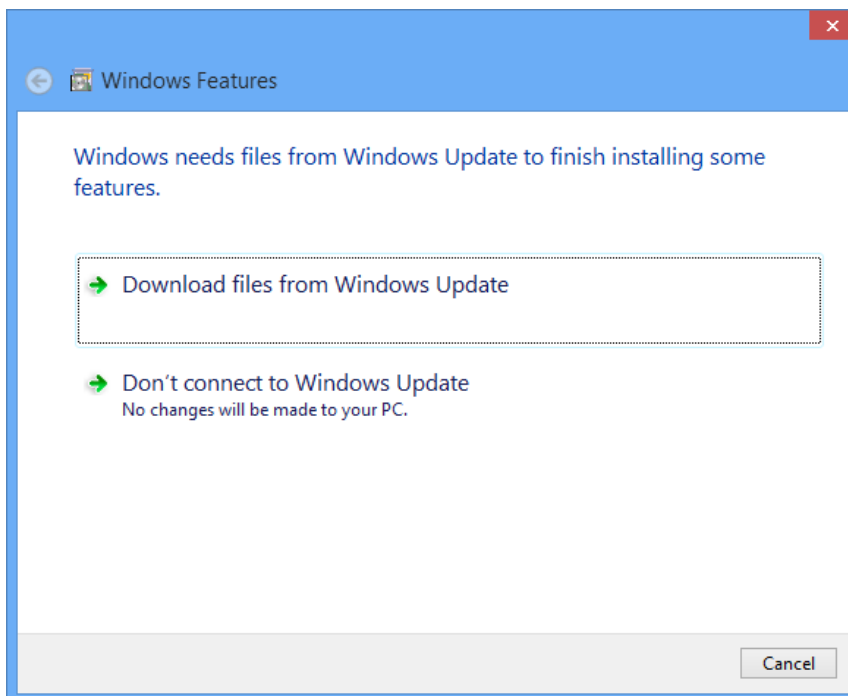

Figure 51.



**Figure 52.**

Select Download and Install this feature.



**Figure 53.**

Select Download Files from Windows Update.

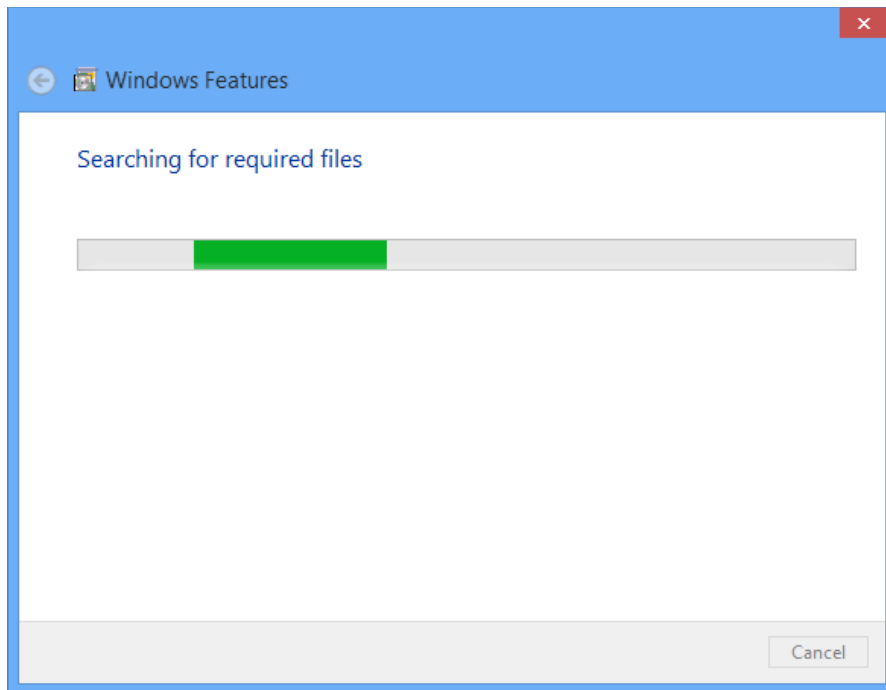

Figure 54.

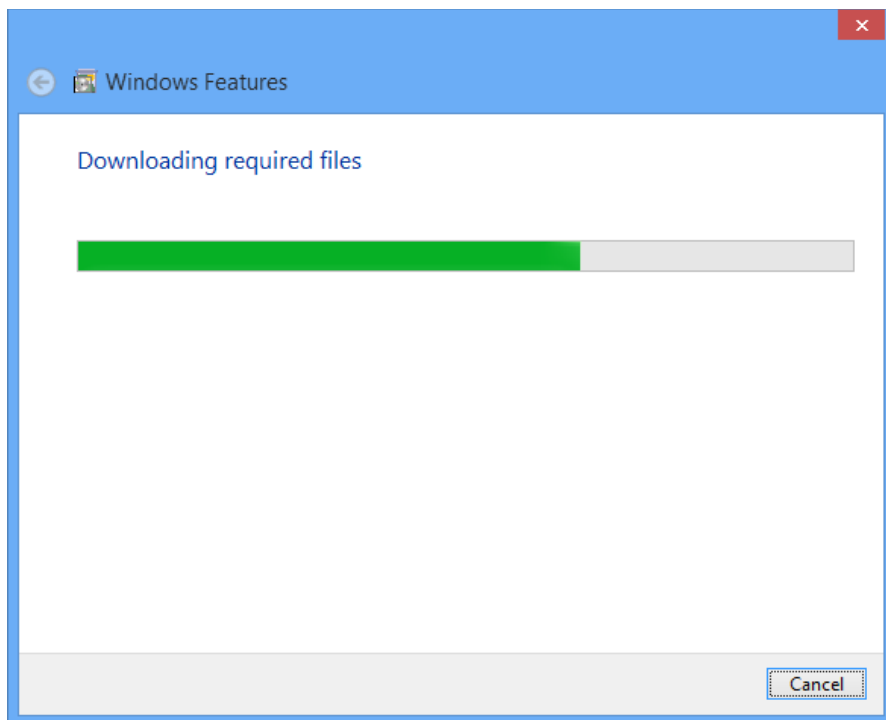

Figure 55.

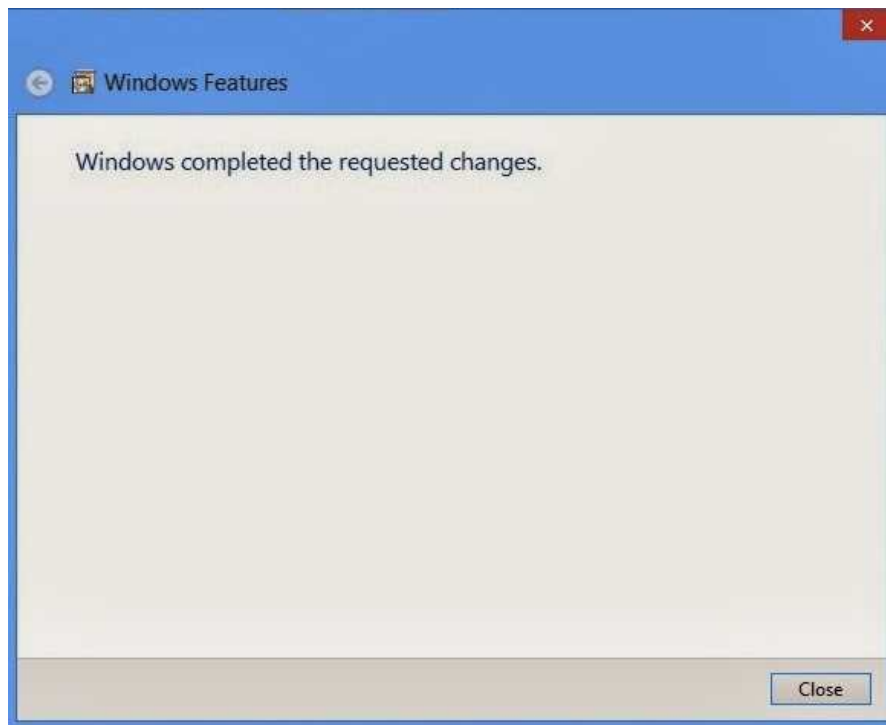

Figure 56.

**10.8.2 Method 2 (Enabling .NET Framework 3.5 on Windows 8 in Offline Mode)**

This is basically using Windows 8 CD to enable/install .NET FRAMEWORK 3.5 in the PC. This method does not require an internet connection.

Step 1: Insert Windows 8 DVD or mount ISO image. The source of this feature can be found in folder E:\sources\sxs. (In this case E: is the user’s drive letter on which the user has loaded Windows 8 Media.)

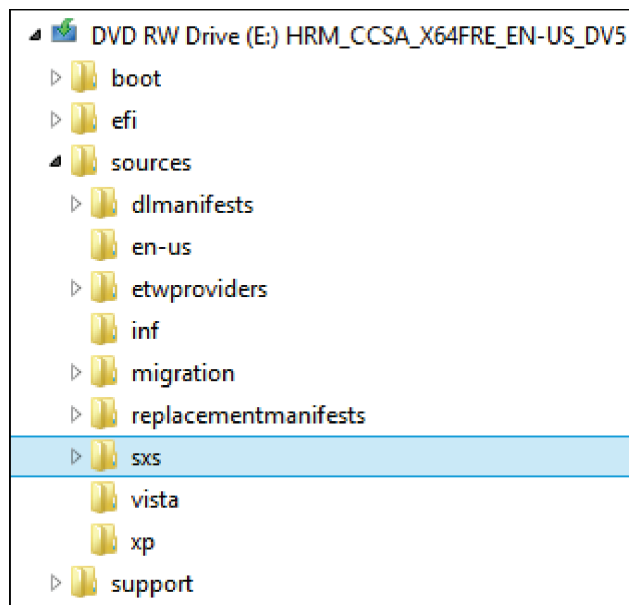
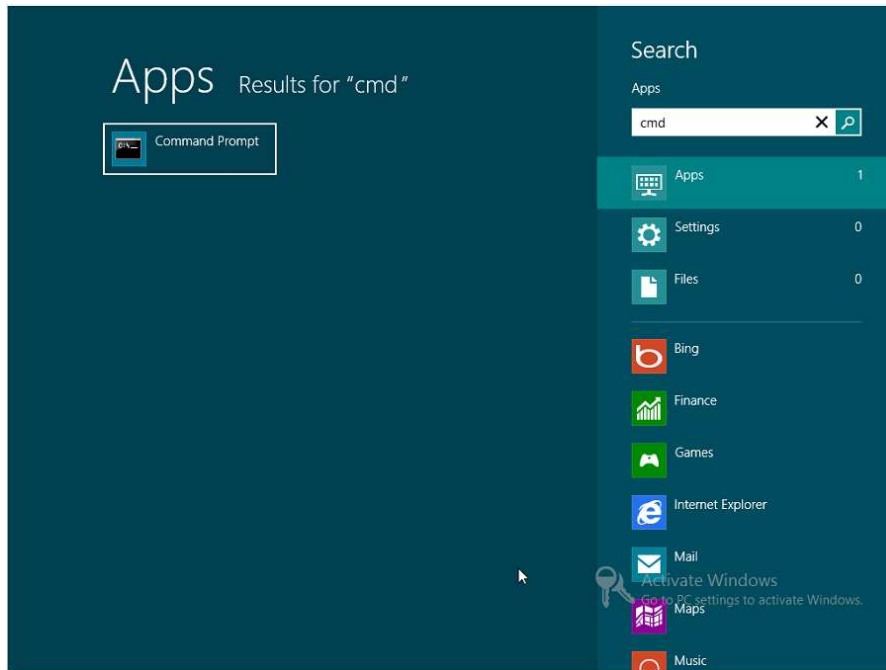
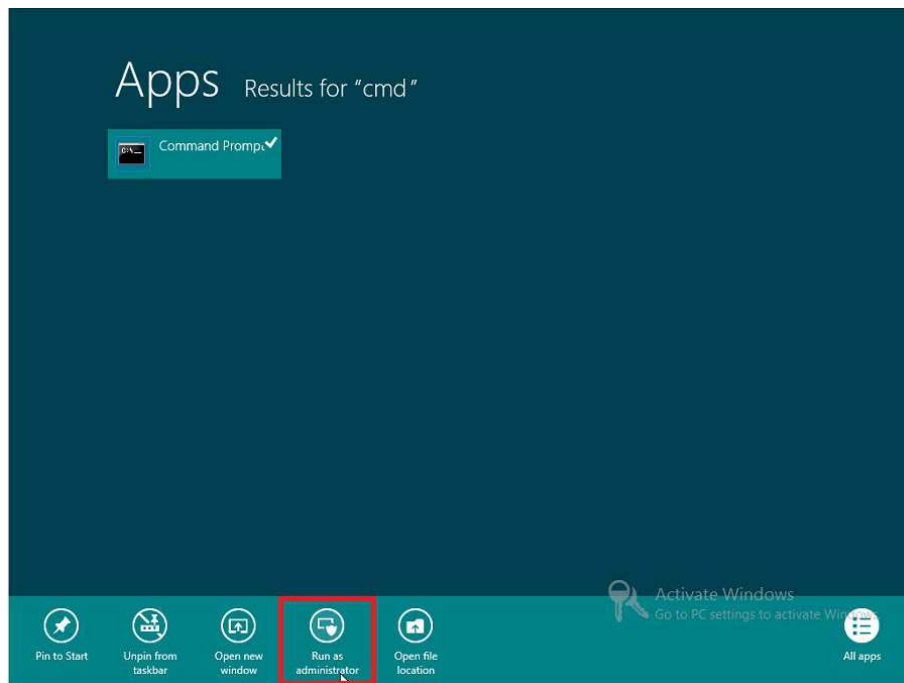

Figure 57.

Step 2: Open Command prompt as administrator.



**Figure 58.**



**Figure 59.**

Step 3: Run the following command `Dism.exe /online /enable-feature /featurename:NetFx3 /All /Source:E:\sources\sxs /LimitAccess`, and hit Enter. Make sure to choose the appropriate drive letter (in this case it is E:).

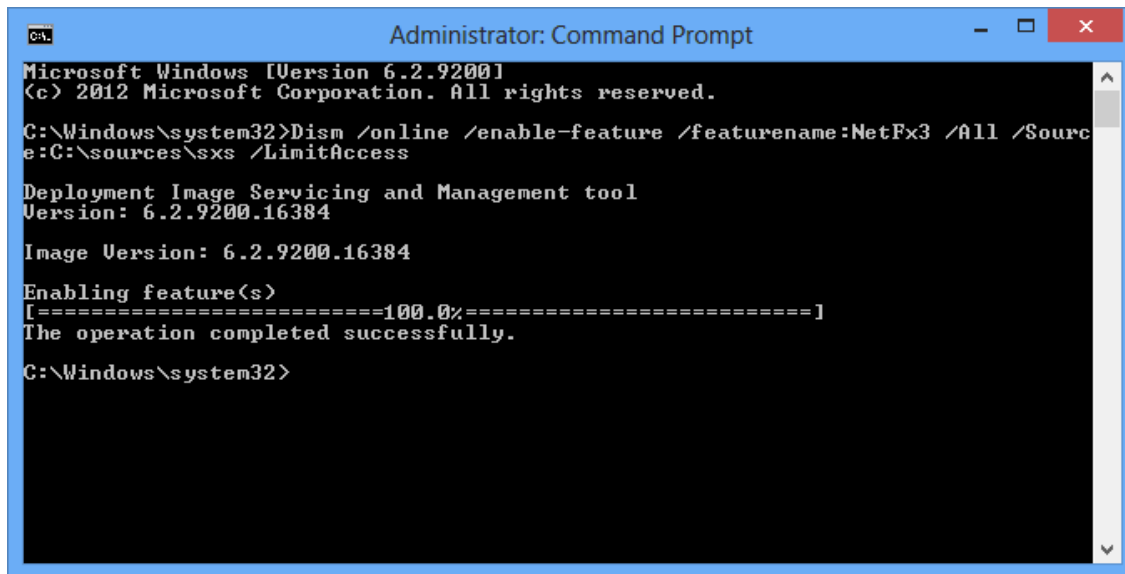

Figure 60.

Method 2 source: <http://support.microsoft.com/kb/2785188>

Table 8. Troubleshoot and Links

Description	Link
Installing the .NET Framework 3.5 on Windows 8 or 8.1	<a href="http://msdn.microsoft.com/library/hh506443(v=VS.110).aspx">http://msdn.microsoft.com/library/hh506443(v=VS.110).aspx</a>
Enable .NET Framework 3.5 on Windows 8 in Offline Mode	<a href="http://support.microsoft.com/kb/2785188">http://support.microsoft.com/kb/2785188</a>
.NET Framework 3.5 installation error: 0x800F0906, 0x800F081F, 0x800F0907	<a href="http://support.microsoft.com/kb/2734782">http://support.microsoft.com/kb/2734782</a>
Other helpful link	<a href="http://comps-tech-solution.blogspot.in/2013/09/how-to-install-net-framework-35-in.html">http://comps-tech-solution.blogspot.in/2013/09/how-to-install-net-framework-35-in.html</a>

### 10.9 COM Port

It has been observed that on certain machines, the GUI will not work for lower COM ports. When the GUI and the USB drivers are installed correctly and the Device Manager shows the AFE44x0SPO2EVM recognized as a virtual COM port, but the GUI cannot establish communication to the AFE44x0SPO2EVM and shows the Device Communication Error, change the COM port to a higher number (greater than 25).

## 11 Bill of Materials

The following pages show the bill of materials (landscaped for readability).

**Table 9. AFE44x0SPO2EVM Bill of Materials**

AFE4400EVM Qty	AFE4490EVM Qty	REF DES	Value or Function	Description	MFG	MFG Part#	Comments
1	1	NA	0.062"-FR4-RoHS	Printed Circuit Board	TI	AFE44x0SPO2EVM REV.A	
12	12	C1, C3, C4, C8, C9, C10, C14, C16, C20, C22, C26, C30, C31, C33, C34, C37, C38, C43, C49, C50, C53, C57, C66	0.1uF	0402_CF	Murata	GRM155R71C104KA88D	C1, C3, C4, C20, C22, C30, C33, C34, C37, C49, C66 - DNI
2	2	C11, C13	12pF	0402_CF	Murata	GRM1555C1H120JA01D	
6	6	C12, C27, C55, C58, C59, C62	0.01uF	0402_CF	Murata	GCM155R71H103KA55D	
1	1	C15	1uF	0402_CF	Murata	GRM155R61A105KE15D	
4	4	C17, C18, C21, C24	10pF	0402_CF	Murata	GRM1555C1H100JA01D	
1	1	C19, C39	2200pF	0402_CF	Murata	GRM155R71H222KA01D	C19 - DNI
14	14	C2, C28, C29, C32, C45, C46, C47, C48, C52, C54, C56, C60, C61, C63, C64, C65	10uF	0805_HV	Murata	GRM21BR61C106KE15L	C2, C45 - DNI
0	0	C23	10nF	0402-CF	Murata	GCM155R71H103KA88D	C23 - DNI
1	1	C25	4.7uF	0402_CF	Murata	GRM155R60J475ME87D	
1	1	C35	1uF	0603_CFE	Murata	GRM185C80J105KE26D	
1	1	C36	1000pF	0402_CF	Murata	GRM155R71H102KA01D	
3	3	C40, C41, C42	2.2uF	0603-CF	Kemet	GRM188R60J225KE19D	
1	1	C5	0.47uF	0402_CF	Murata	GRM155R60J474KE19D	
0	0	C51	22uF	0805_CF	AVX Corporation	TLJN226M006R5400	C51 - DNI
2	2	C6, C7	18pF	0402_CF	Murata	GRM1555C1H180JA01D	
4	4	D1, D2, D3, D4	75V	SOT-323	Diodes Inc	BAV99W-7-F	
1	1	D5	0.55V	SOD-123	Diodes Inc.	SD103AW-7-F	
0	0	D6	AZ23C5V6	SOT-23	Commercial Co	AZ23C5V6-TP	D6 - DNI
0	0	J5	22272021	P2X1	Molex	22272021	J5 - DNI
0	0	J6	473340001	uSD_CC	Molex	473340001	J6 - DNI
1	1	J2	Oxymeter Finger Probe I/F	DB9-Female Connector	Kycon, Inc.	K202XHT-E9S-N	
0	0	J3	TC2050-IDC-FP, Footprint Only	TC2050-IDC-FP	Tag-Connect	TC2050-IDC-FP	Footprint only - Non-BOM
1	1	J4	513870530	mUSB B	Molex Inc	513870530	
0	0	J1	CNT	850-40-006-20-001000	Mill-Max	850-40-006-20-001000	J1 - DNI
6	6	L1, L2, L3, L4, L5, L6	10uH	LPS3010	Coilcraft	LPS3010-103MLB	
1	1	Q1	0R	SOT-23	ON Semiconductor	MMBT5089LT1G	
0	0	R114	.02E	RES .02 OHM 1/4W 1% 1206 SMD	Vishay/Dale	WSL1206R0200FEA	R114 - DNI
12	12	R2, R5, R15, R16, R17, R24, R27, R50, R51, R68, R73, R82, R91	0R	0402_CF	Vishay-Dale	CRCW04020000Z0ED	R15 - DNI
11	11	R44, R48, R54, R55, R58, R60, R65, R66, R67, R69, R71, R76	0R	0603 - Jumper	Vishay-Dale	CRCW06030000Z0EA	R58 - DNI
1	1	R28	1.00k	0402_CF	Vishay-Dale	CRCW04021K00FKED	
1	1	R52	1.0Meg	0402_CF	Vishay-Dale	CRCW04021M00JNED	

**Table 9. AFE44x0SPO2EVM Bill of Materials (continued)**

AFE4400EVM Qty	AFE4490EVM Qty	REF DES	Value or Function	Description	MFG	MFG Part#	Comments
1	1	R96	1.40k	0402_CF	Vishay-Dale	CRCW04021K40FKED	
2	2	R53, R95, R108, R109, R116, R117	100R	0402_CF	Vishay-Dale	CRCW0402100RJNED	R108, R109, R116, R117 - DNI
11	11	R10, R11, R12, R56, R59, R62, R64, R78, R98, R99, R100, R101, R104, R105, R107, R110, R111, R112, R113	10K	0402_CF	Panasonic - ECG	ERJ-2GEJ103X	R10, R11, R12, R56, R64, R78, R104, R111-DNI
19	19	R1, R6, R7, R8, R9, R13, R14, R18, R19, R21, R23, R25, R26, R29, R30, R31, R33, R34, R35	10R	0402-CF	Vishay-Dale	CRCW040210R0JNED	
16	16	R37, R38, R39, R42, R43, R45, R49, R84, R85, R86, R87, R88, R89, R90, R93, R94	10R	0402-CF	Vishay-Dale	CRCW040210R0JNED	
7	7	R3, R20, R22, R32, R36, R40, R41	130R	0402_CF	Vishay-Dale	CRCW0402130RJNED	
1	1	R4	220R	0402_CF	Vishay-Dale	CRCW0402220RJNED	
2	2	R57, R61	33R	0402_CF	Vishay-Dale	CRCW040233R0JNED	
0	0	R46, R47	4.7k	0603-CFE	Yageo	RC0603JR-104K7L	R46, R47 - DNI
2	2	R81, R92	4.7k	0402_CF	Vishay-Dale	CRCW04024K70JNED	
3	3	R83, R103, R115	47k	0402_CF	Vishay-Dale	CRCW040247K0JNED	
2	2	LED2, LED3	Blue	LED BLUE 0603 SMD	Rohm Semiconductor	SMLE12BC7TT86	
1	1	LED1	Green	LED GREEN 0603 SMD	Rohm Semiconductor	SMLE12EC6TT86	
1	1	R70, R79, R80, R118	1.0k	0402_CF	Vishay-Dale	CRCW04021K00JNED	R70, R80, R118 - DNI
1	1	R72	261k	0603_CFE	Vishay-Dale	CRCW0603261KFKEA	
1	1	R75	200k	0402_CF	Vishay-Dale	CRCW0402200KJNED	
1	1	R74	15.4k	0603_CFE	Vishay-Dale	CRCW060315K4FKEA	
0	1	R77	4.02k	0402_CF	Vishay-Dale	CRCW04024K02FKED	
1	0	R77	2.32k	0402_CF	Vishay-Dale	CRCW04022K32FKED	
2	2	R63, R106	75k	0402_CF	Vishay-Dale	CRCW040275K0FKED	
1	1	R102	50k	0402_CF	Panasonic - ECG	ERJ-2GEJ503X	
2	2	SW1, SW2	Switch, PB	PTS635SL25SMT	C&K Components	PTS635SL25SMT	
0	0	TP1, TP2, TP3, TP4, TP5, TP6, TP7, TP8, TP9, TP10, TP11, TP12, TP13, TP14, TP15, TP16, TP17, TP18, TP19, TP20, TP21, TP22, TP23	TP	TestPoint_10_20	N/A	Pads Only - Non-BOM	Pads Only - Non-BOM
0	0	TP24, TP25, TP26, TP27, TP28, TP29, TP30, TP31, TP32, TP33, TP34, TP35, TP36, TP37, TP38, TP39, TP40, TP41, TP42, TP43, TP44, TP45	TP	TestPoint_10_20	N/A	Pads Only - Non-BOM	Pads Only - Non-BOM
1	0	U1	Analog Front End, Mixed Signal IC	RHA40	Texas Instruments	AFE4400	
0	1	U1	Analog Front End, Mixed Signal IC	RHA40	Texas Instruments	AFE4490	
0	0	U3,U5	2Mb-Serial FeRAM	M08A_N	RAMTRON	FM25V20-GTR	U3, U5 - DNI
0	0	U10	BQ27200	DFN-10	Texas Instruments	BQ27200DRKR	U10 - DNI
1	1	U12	BQ24032ARHLR, 4.2V	Power-Path Management & Li-ion charger	Texas Instruments	BQ24032ARHLR	
0	0	U4	8-CHNL ESD ARRAY	EIGHT-CHANNEL ESD ARRAY	Texas Instruments	TPD8E003DQDR	U4 - DNI



**Table 9. AFE44x0SPO2EVM Bill of Materials (continued)**

AFE4400EVM Qty	AFE4490EVM Qty	REF DES	Value or Function	Description	MFG	MFG Part#	Comments
1	1	U11	TPS3825	DBV-5	Texas Instruments	TPS3825-33DBVT	
1	1	U2	MSP430 Micro IC	TSQFP50P1400X1400X160-80N	Texas Instruments	MSP430F5529IPN	
1	1	U7	15KV ESD-protection diode array	ESD-protection diode array	Texas Instruments	TPD4E004DRY	
0	0	U6	9Axis Orientation/Motion	10-VDFDN	Invensense	MPU9150	U6 - DNI
1	1	U8	LDO Regulator IC	MRA08A	National Semiconductor	LP3878MR-ADJ/NOPB	
1	1	U9	Voltage Regulator IC	TSQFP50P250X250X80_HS-10N	Texas Instruments	TPS61093DSK	
2	2	U13 ,U14	Voltage Regulator IC	TSOP65P490X110_HS-8N	Texas Instruments	TPS7A4901DGN	
1	1	Y1	8MHz	XTAL_ABM3	Abracon Corporation	ABM3-8.000MHz-D2Y-T	
1	1	Y2	32.768KHz	ABS07	Abracon Corporation	ABS07-32.768KHZ-T	
1	1	Y3	24.000MHZ	XTAL_ABM3B-4	Abracon Corporation	ABM3B-24.000MHZ-10-1-U-T	

## 12 PCB Layouts and Schematics

### 12.1 AFE44x0SPO2EVM PCB Layouts

Figure 61 through Figure 68 show the EVM PCB layouts (landscaped for readability).

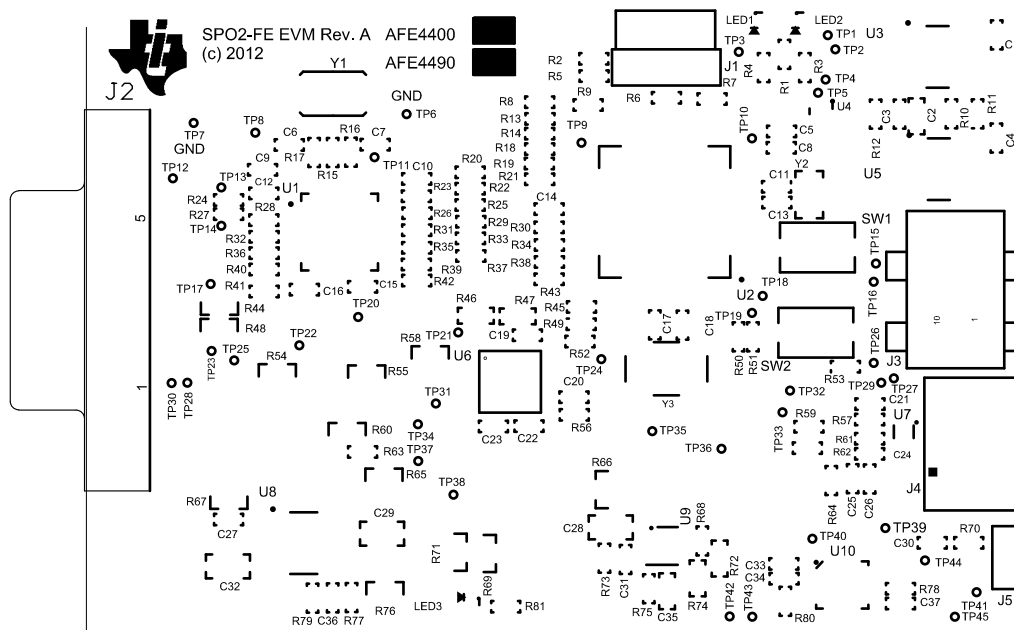

Figure 61. AFE44x0SPO2EVM Top Overlay

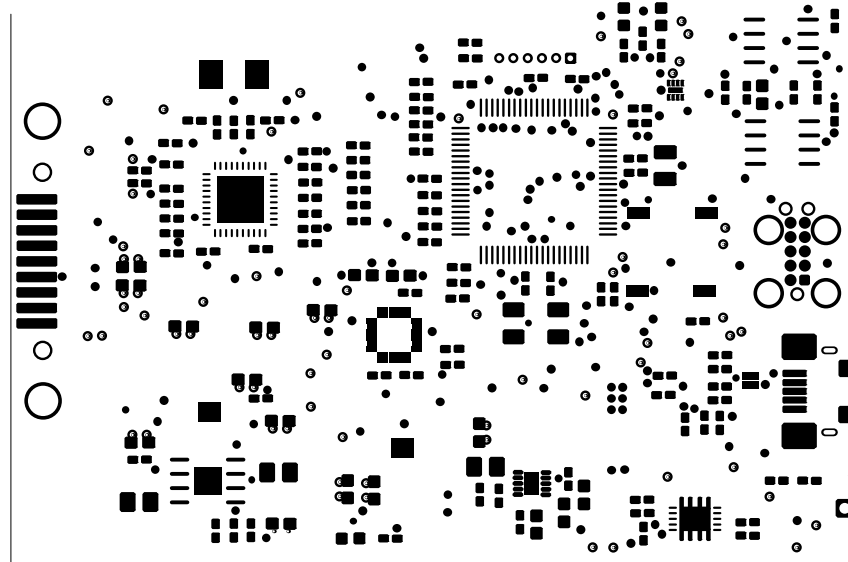

Figure 62. AFE44x0SPO2EVM Top Solder

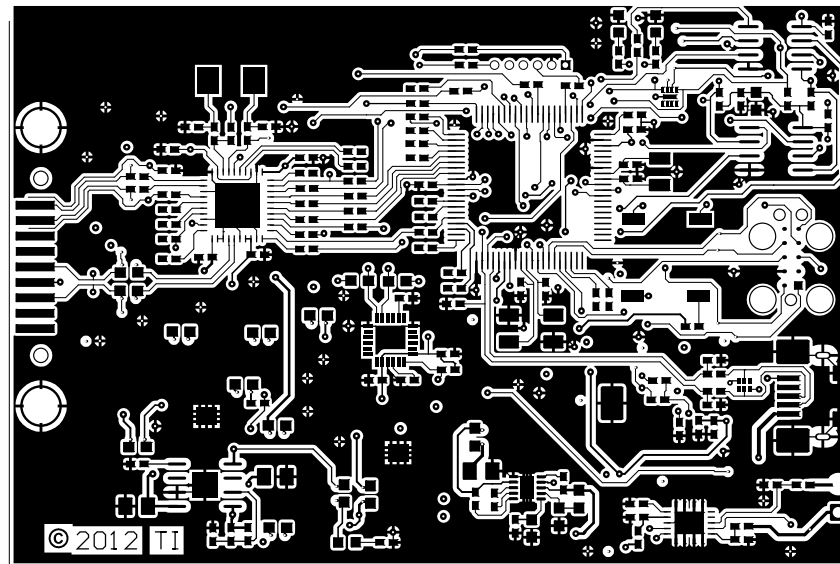

Figure 63. AFE44x0SPO2EVM Top Layer

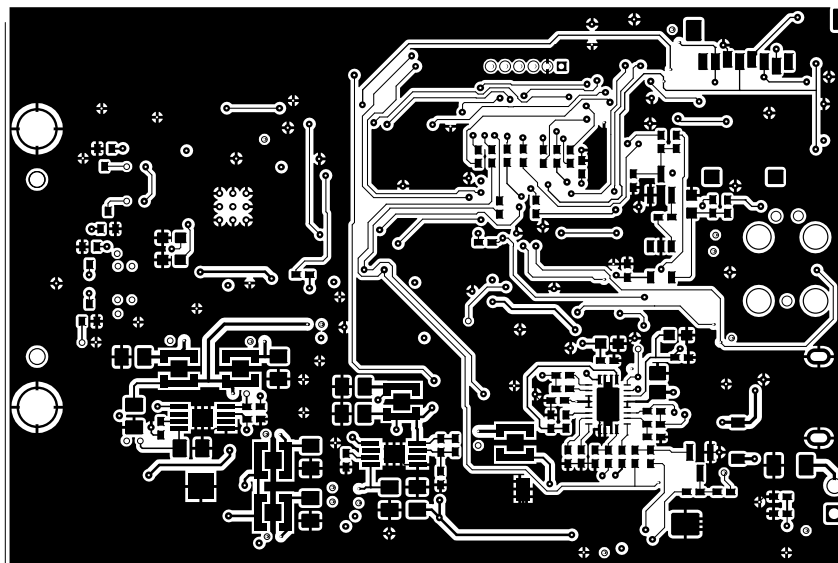

Figure 64. AFE44x0SPO2EVM Bottom Layer

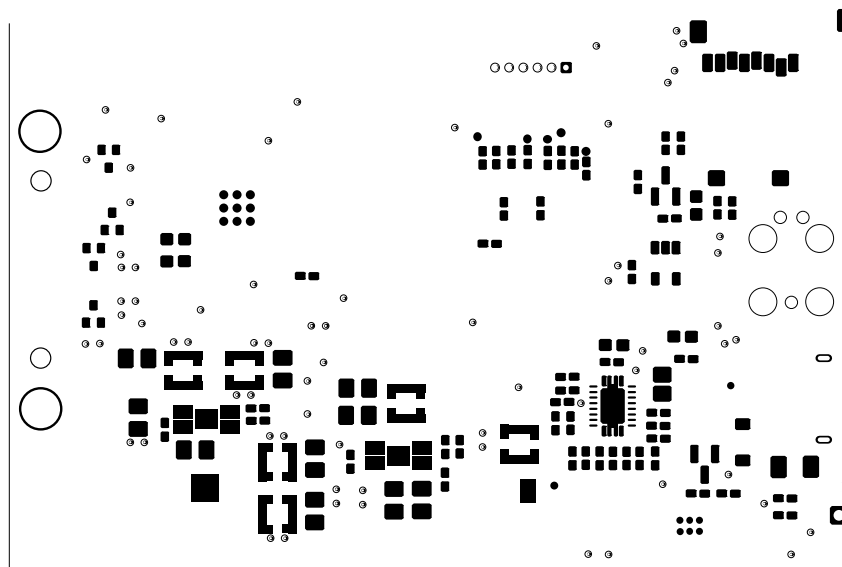
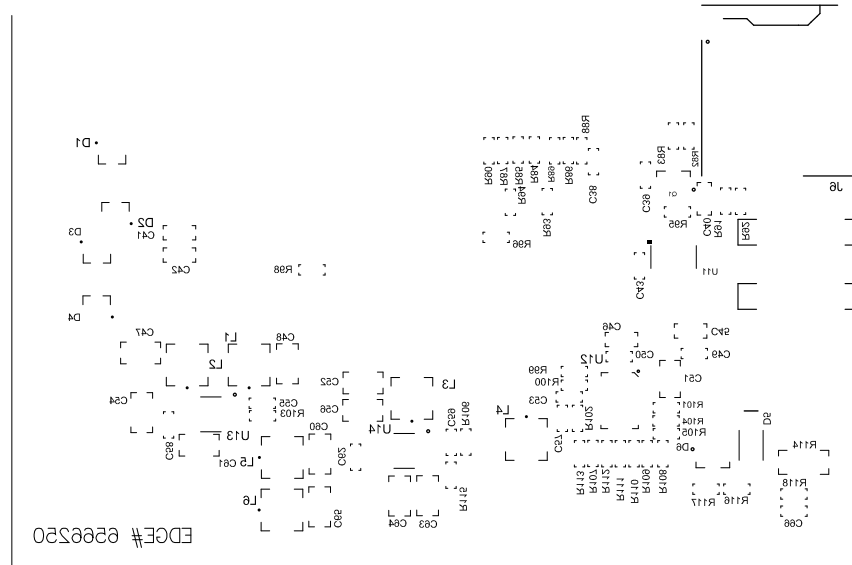
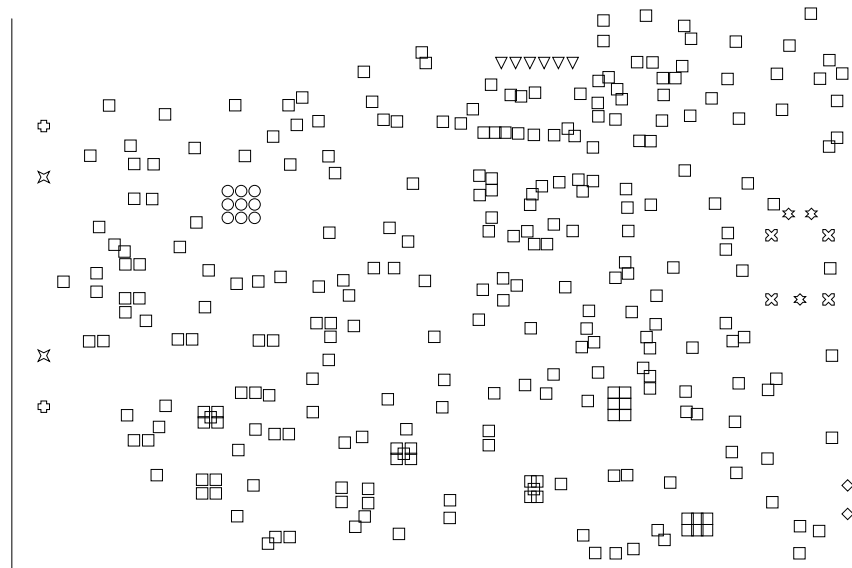

Figure 65. AFE44x0SPO2EVM Bottom Solder



**Figure 66. AFE44x0SPO2EVM Bottom Overlay**



**Figure 67. AFE44x0SPO2EVM Drill Drawing**

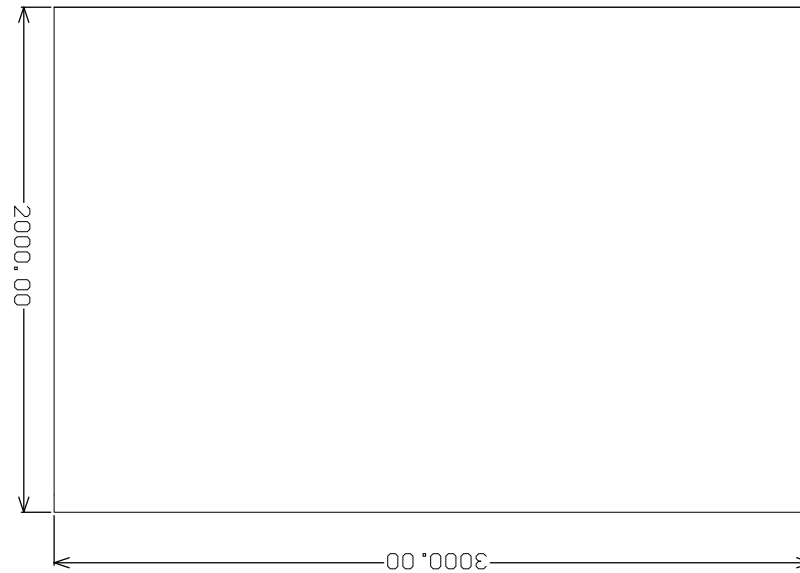

**Figure 68. AFE44x0SPO2EVM Board Dimensions (in mils)**

## 12.2 AFE44x0SPO2EVM Schematics

Figure 69 through Figure 72 show the EVM schematics (landscaped for readability).

### AFE44x0

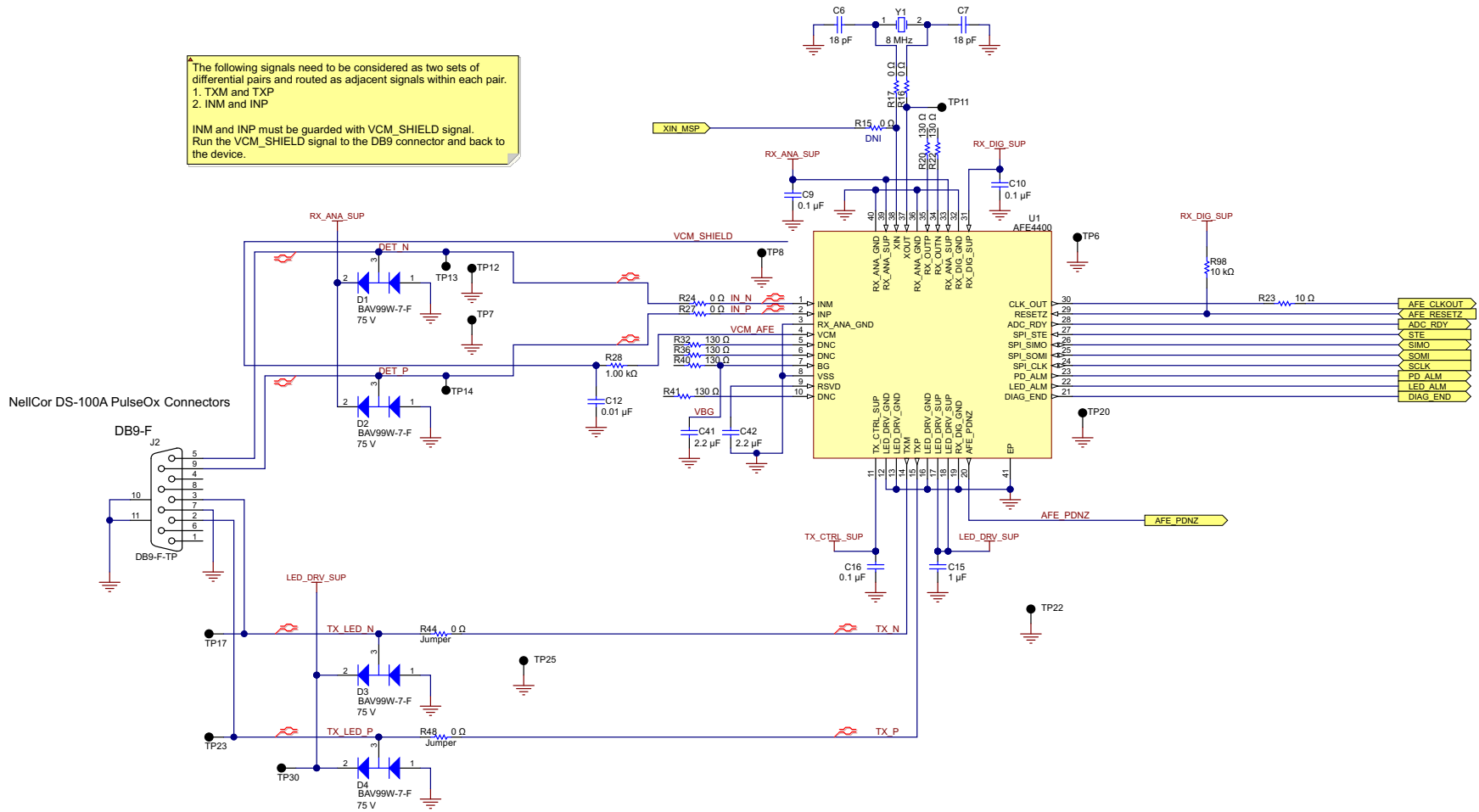

Figure 69. AFE44x0SPO2EVM: AFE44x0 Schematic (1 of 4)

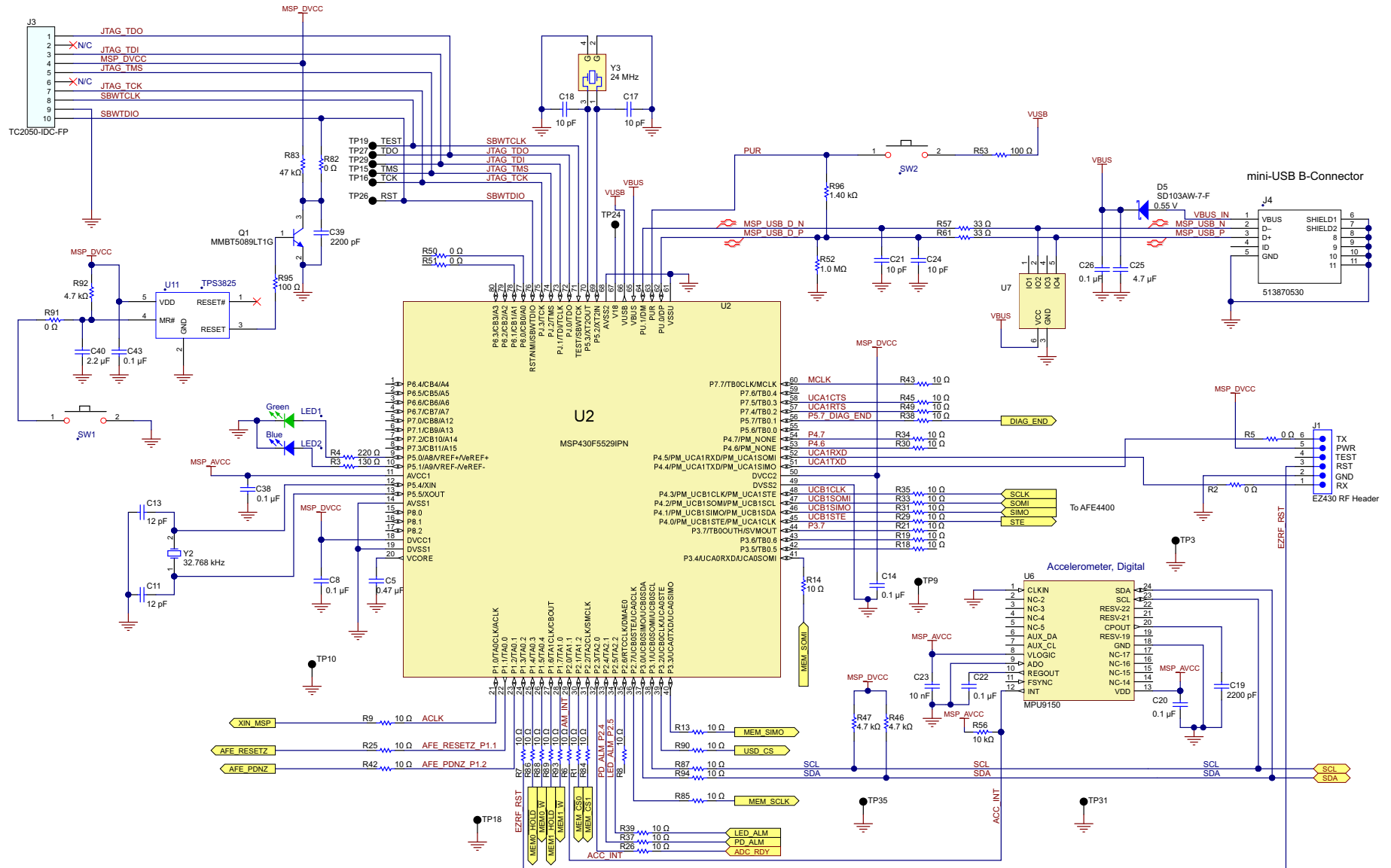

Figure 70. AFE44x0SPO2EVM: MSP430 (2 of 4)



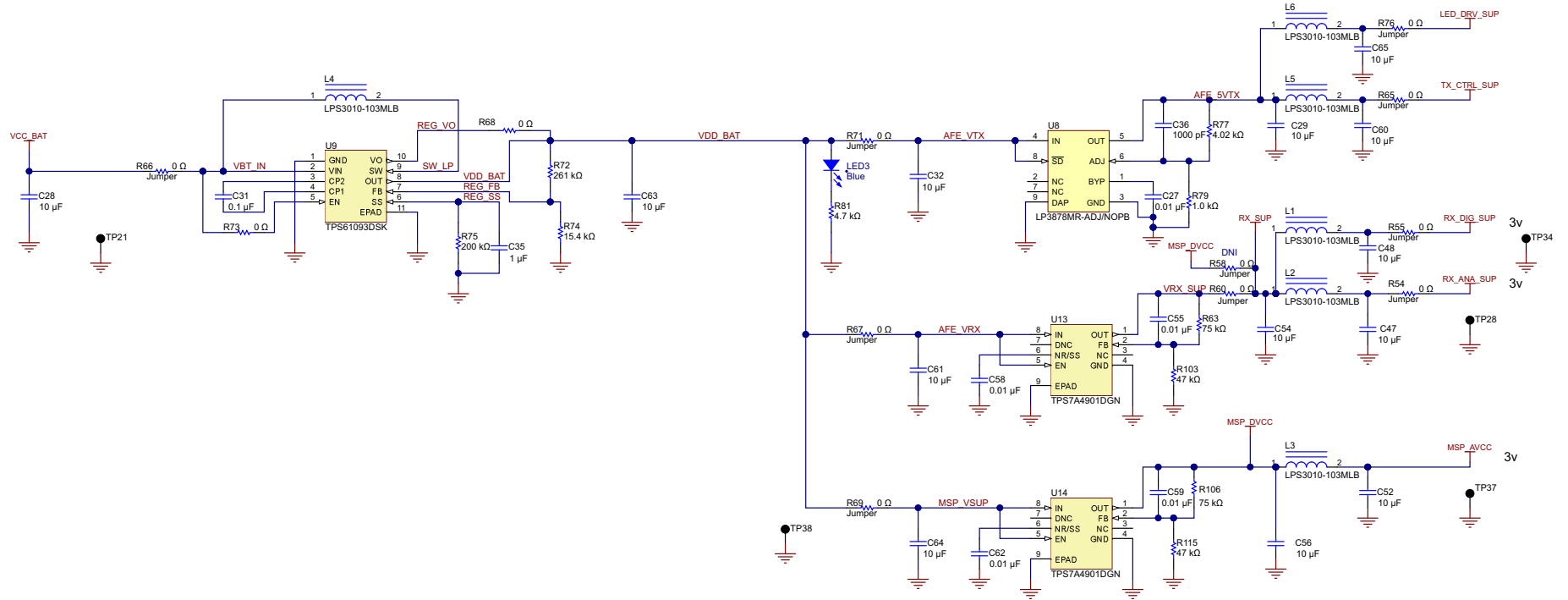
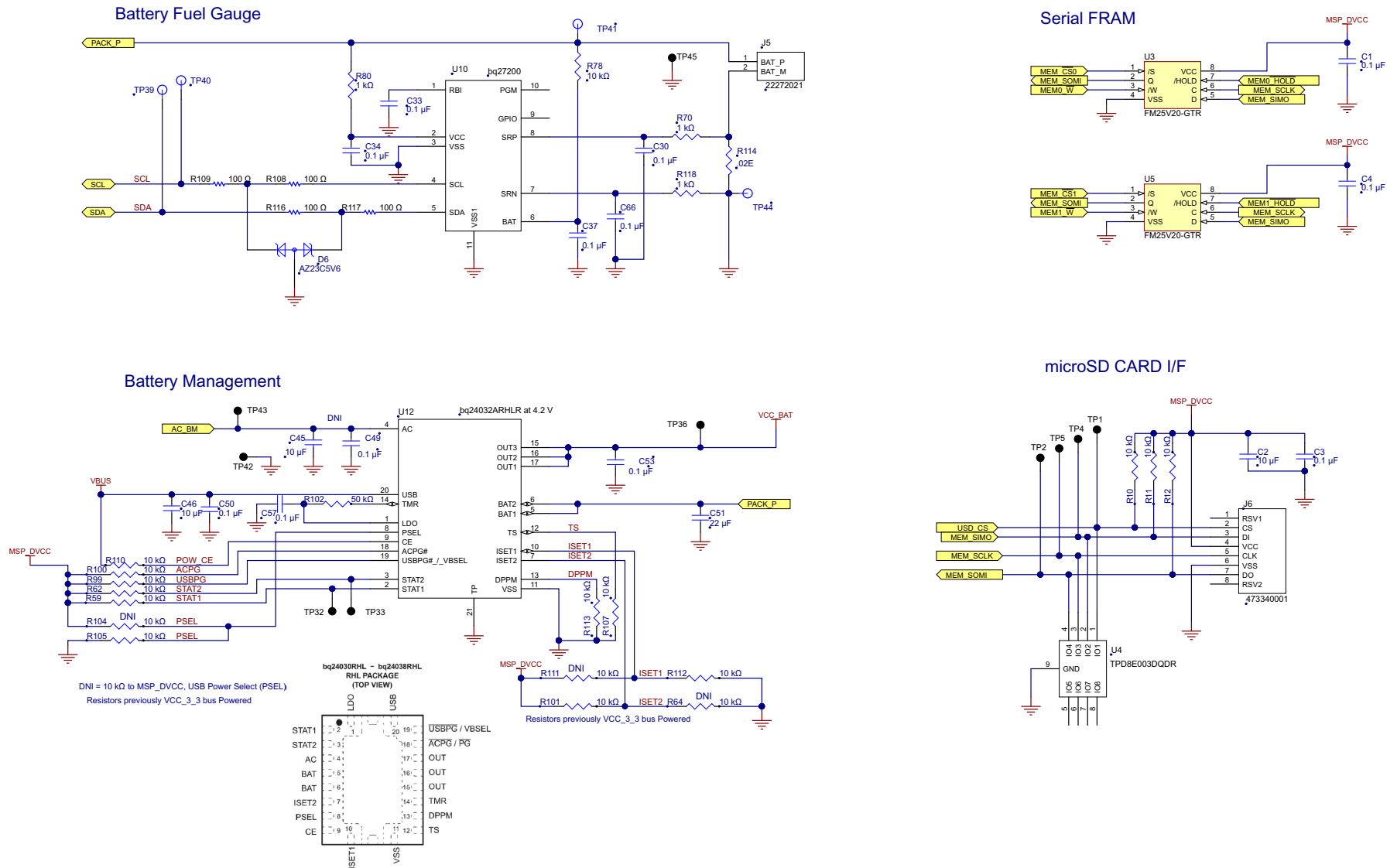

Figure 71. AFE44x0SPO2EVM: Power Supply (3 of 4)



## Revision C History

<b>Changes from B Revision (May 2014) to C Revision</b>	<b>Page</b>
• Replaced <a href="#">Figure 69</a> through <a href="#">Figure 72</a> with updated schematics .....	55
• Removed AFE44x0SPO2EVM Blocks schematic .....	58

NOTE: Page numbers for previous revisions may differ from page numbers in the current version.

## Revision B History

<b>Changes from A Revision (February 2013) to B Revision</b>	<b>Page</b>
• Updated the features supported in <a href="#">Section 2.3</a> .....	3
• Updated GUI screenshots throughout sections .....	7
• Added <a href="#">Section 3.3.1</a> Windows 8 Installing Unsigned Drivers .....	11
• Updated number of samples in <a href="#">Section 4.1.2</a> .....	24
• Updated examples in <a href="#">Section 4.1.2</a> for the new 32 point FFT feature. ....	24
• Removed section regarding the % SpO2 and HR Display .....	26
• Added a note about the firmware upgrade for <a href="#">Section 6</a> .....	31
• Corrected firmware file name .....	31
• Added a caution for <a href="#">Section 10.1</a> .....	37
• Added <a href="#">Section 10.8</a> Windows 8 Support for Device GUIs .....	40

NOTE: Page numbers for previous revisions may differ from page numbers in the current version.

## STANDARD TERMS AND CONDITIONS FOR EVALUATION MODULES

1. *Delivery:* TI delivers TI evaluation boards, kits, or modules, including any accompanying demonstration software, components, or documentation (collectively, an "EVM" or "EVMs") to the User ("User") in accordance with the terms and conditions set forth herein. Acceptance of the EVM is expressly subject to the following terms and conditions.
  - 1.1 EVMs are intended solely for product or software developers for use in a research and development setting to facilitate feasibility evaluation, experimentation, or scientific analysis of TI semiconductors products. EVMs have no direct function and are not finished products. EVMs shall not be directly or indirectly assembled as a part or subassembly in any finished product. For clarification, any software or software tools provided with the EVM ("Software") shall not be subject to the terms and conditions set forth herein but rather shall be subject to the applicable terms and conditions that accompany such Software
  - 1.2 EVMs are not intended for consumer or household use. EVMs may not be sold, sublicensed, leased, rented, loaned, assigned, or otherwise distributed for commercial purposes by Users, in whole or in part, or used in any finished product or production system.
2. *Limited Warranty and Related Remedies/Disclaimers:*
  - 2.1 These terms and conditions do not apply to Software. The warranty, if any, for Software is covered in the applicable Software License Agreement.
  - 2.2 TI warrants that the TI EVM will conform to TI's published specifications for ninety (90) days after the date TI delivers such EVM to User. Notwithstanding the foregoing, TI shall not be liable for any defects that are caused by neglect, misuse or mistreatment by an entity other than TI, including improper installation or testing, or for any EVMs that have been altered or modified in any way by an entity other than TI. Moreover, TI shall not be liable for any defects that result from User's design, specifications or instructions for such EVMs. Testing and other quality control techniques are used to the extent TI deems necessary or as mandated by government requirements. TI does not test all parameters of each EVM.
  - 2.3 If any EVM fails to conform to the warranty set forth above, TI's sole liability shall be at its option to repair or replace such EVM, or credit User's account for such EVM. TI's liability under this warranty shall be limited to EVMs that are returned during the warranty period to the address designated by TI and that are determined by TI not to conform to such warranty. If TI elects to repair or replace such EVM, TI shall have a reasonable time to repair such EVM or provide replacements. Repaired EVMs shall be warranted for the remainder of the original warranty period. Replaced EVMs shall be warranted for a new full ninety (90) day warranty period.
3. *Regulatory Notices:*
  - 3.1 *United States*
    - 3.1.1 *Notice applicable to EVMs not FCC-Approved:*

This kit is designed to allow product developers to evaluate electronic components, circuitry, or software associated with the kit to determine whether to incorporate such items in a finished product and software developers to write software applications for use with the end product. This kit is not a finished product and when assembled may not be resold or otherwise marketed unless all required FCC equipment authorizations are first obtained. Operation is subject to the condition that this product not cause harmful interference to licensed radio stations and that this product accept harmful interference. Unless the assembled kit is designed to operate under part 15, part 18 or part 95 of this chapter, the operator of the kit must operate under the authority of an FCC license holder or must secure an experimental authorization under part 5 of this chapter.
    - 3.1.2 *For EVMs annotated as FCC – FEDERAL COMMUNICATIONS COMMISSION Part 15 Compliant:*

### CAUTION

This device complies with part 15 of the FCC Rules. Operation is subject to the following two conditions: (1) This device may not cause harmful interference, and (2) this device must accept any interference received, including interference that may cause undesired operation.

Changes or modifications not expressly approved by the party responsible for compliance could void the user's authority to operate the equipment.

### FCC Interference Statement for Class A EVM devices

*NOTE: This equipment has been tested and found to comply with the limits for a Class A digital device, pursuant to part 15 of the FCC Rules. These limits are designed to provide reasonable protection against harmful interference when the equipment is operated in a commercial environment. This equipment generates, uses, and can radiate radio frequency energy and, if not installed and used in accordance with the instruction manual, may cause harmful interference to radio communications. Operation of this equipment in a residential area is likely to cause harmful interference in which case the user will be required to correct the interference at his own expense.*

## FCC Interference Statement for Class B EVM devices

*NOTE: This equipment has been tested and found to comply with the limits for a Class B digital device, pursuant to part 15 of the FCC Rules. These limits are designed to provide reasonable protection against harmful interference in a residential installation. This equipment generates, uses and can radiate radio frequency energy and, if not installed and used in accordance with the instructions, may cause harmful interference to radio communications. However, there is no guarantee that interference will not occur in a particular installation. If this equipment does cause harmful interference to radio or television reception, which can be determined by turning the equipment off and on, the user is encouraged to try to correct the interference by one or more of the following measures:*

- Reorient or relocate the receiving antenna.
- Increase the separation between the equipment and receiver.
- Connect the equipment into an outlet on a circuit different from that to which the receiver is connected.
- Consult the dealer or an experienced radio/TV technician for help.

### 3.2 Canada

#### 3.2.1 For EVMs issued with an Industry Canada Certificate of Conformance to RSS-210

##### **Concerning EVMs Including Radio Transmitters:**

This device complies with Industry Canada license-exempt RSS standard(s). Operation is subject to the following two conditions: (1) this device may not cause interference, and (2) this device must accept any interference, including interference that may cause undesired operation of the device.

##### **Concernant les EVMs avec appareils radio:**

Le présent appareil est conforme aux CNR d'Industrie Canada applicables aux appareils radio exempts de licence. L'exploitation est autorisée aux deux conditions suivantes: (1) l'appareil ne doit pas produire de brouillage, et (2) l'utilisateur de l'appareil doit accepter tout brouillage radioélectrique subi, même si le brouillage est susceptible d'en compromettre le fonctionnement.

##### **Concerning EVMs Including Detachable Antennas:**

Under Industry Canada regulations, this radio transmitter may only operate using an antenna of a type and maximum (or lesser) gain approved for the transmitter by Industry Canada. To reduce potential radio interference to other users, the antenna type and its gain should be so chosen that the equivalent isotropically radiated power (e.i.r.p.) is not more than that necessary for successful communication. This radio transmitter has been approved by Industry Canada to operate with the antenna types listed in the user guide with the maximum permissible gain and required antenna impedance for each antenna type indicated. Antenna types not included in this list, having a gain greater than the maximum gain indicated for that type, are strictly prohibited for use with this device.

##### **Concernant les EVMs avec antennes détachables**

Conformément à la réglementation d'Industrie Canada, le présent émetteur radio peut fonctionner avec une antenne d'un type et d'un gain maximal (ou inférieur) approuvé pour l'émetteur par Industrie Canada. Dans le but de réduire les risques de brouillage radioélectrique à l'intention des autres utilisateurs, il faut choisir le type d'antenne et son gain de sorte que la puissance isotrope rayonnée équivalente (p.i.r.e.) ne dépasse pas l'intensité nécessaire à l'établissement d'une communication satisfaisante. Le présent émetteur radio a été approuvé par Industrie Canada pour fonctionner avec les types d'antenne énumérés dans le manuel d'usage et ayant un gain admissible maximal et l'impédance requise pour chaque type d'antenne. Les types d'antenne non inclus dans cette liste, ou dont le gain est supérieur au gain maximal indiqué, sont strictement interdits pour l'exploitation de l'émetteur.

### 3.3 Japan

3.3.1 *Notice for EVMs delivered in Japan:* Please see [http://www.tij.co.jp/lstds/ti\\_ja/general/eStore/notice\\_01.page](http://www.tij.co.jp/lstds/ti_ja/general/eStore/notice_01.page) 日本国内に輸入される評価用キット、ボードについては、次のところをご覧ください。  
[http://www.tij.co.jp/lstds/ti\\_ja/general/eStore/notice\\_01.page](http://www.tij.co.jp/lstds/ti_ja/general/eStore/notice_01.page)

3.3.2 *Notice for Users of EVMs Considered "Radio Frequency Products" in Japan:* EVMs entering Japan may not be certified by TI as conforming to Technical Regulations of Radio Law of Japan.

If User uses EVMs in Japan, not certified to Technical Regulations of Radio Law of Japan, User is required by Radio Law of Japan to follow the instructions below with respect to EVMs:

1. Use EVMs in a shielded room or any other test facility as defined in the notification #173 issued by Ministry of Internal Affairs and Communications on March 28, 2006, based on Sub-section 1.1 of Article 6 of the Ministry's Rule for Enforcement of Radio Law of Japan,
2. Use EVMs only after User obtains the license of Test Radio Station as provided in Radio Law of Japan with respect to EVMs, or
3. Use of EVMs only after User obtains the Technical Regulations Conformity Certification as provided in Radio Law of Japan with respect to EVMs. Also, do not transfer EVMs, unless User gives the same notice above to the transferee. Please note that if User does not follow the instructions above, User will be subject to penalties of Radio Law of Japan.

【無線電波を送信する製品の開発キットをお使いになる際の注意事項】 開発キットの中には技術基準適合証明を受けていないものがあります。技術適合証明を受けていないものご使用に際しては、電波法遵守のため、以下のいずれかの措置を取っていただく必要がありますのでご注意ください。

1. 電波法施行規則第6条第1項第1号に基づく平成18年3月28日総務省告示第173号で定められた電波暗室等の試験設備でご使用いただく。
2. 実験局の免許を取得後ご使用いただく。
3. 技術基準適合証明を取得後ご使用いただく。

なお、本製品は、上記の「ご使用にあたっての注意」を譲渡先、移転先に通知しない限り、譲渡、移転できないものとします。

上記を遵守頂けない場合は、電波法の罰則が適用される可能性があることをご留意ください。日本テキサス・インスツルメンツ株式会社  
東京都新宿区西新宿 6 丁目 2 4 番 1 号  
西新宿三井ビル

3.3.3 *Notice for EVMs for Power Line Communication:* Please see [http://www.tij.co.jp/llds/ti\\_ja/general/eStore/notice\\_02.page](http://www.tij.co.jp/llds/ti_ja/general/eStore/notice_02.page)  
電力線搬送波通信についての開発キットをお使いになる際の注意事項については、次のところをご覧ください。[http://www.tij.co.jp/llds/ti\\_ja/general/eStore/notice\\_02.page](http://www.tij.co.jp/llds/ti_ja/general/eStore/notice_02.page)

#### 4 *EVM Use Restrictions and Warnings:*

4.1 EVMS ARE NOT FOR USE IN FUNCTIONAL SAFETY AND/OR SAFETY CRITICAL EVALUATIONS, INCLUDING BUT NOT LIMITED TO EVALUATIONS OF LIFE SUPPORT APPLICATIONS.

4.2 User must read and apply the user guide and other available documentation provided by TI regarding the EVM prior to handling or using the EVM, including without limitation any warning or restriction notices. The notices contain important safety information related to, for example, temperatures and voltages.

#### 4.3 *Safety-Related Warnings and Restrictions:*

4.3.1 User shall operate the EVM within TI's recommended specifications and environmental considerations stated in the user guide, other available documentation provided by TI, and any other applicable requirements and employ reasonable and customary safeguards. Exceeding the specified performance ratings and specifications (including but not limited to input and output voltage, current, power, and environmental ranges) for the EVM may cause personal injury or death, or property damage. If there are questions concerning performance ratings and specifications, User should contact a TI field representative prior to connecting interface electronics including input power and intended loads. Any loads applied outside of the specified output range may also result in unintended and/or inaccurate operation and/or possible permanent damage to the EVM and/or interface electronics. Please consult the EVM user guide prior to connecting any load to the EVM output. If there is uncertainty as to the load specification, please contact a TI field representative. During normal operation, even with the inputs and outputs kept within the specified allowable ranges, some circuit components may have elevated case temperatures. These components include but are not limited to linear regulators, switching transistors, pass transistors, current sense resistors, and heat sinks, which can be identified using the information in the associated documentation. When working with the EVM, please be aware that the EVM may become very warm.

4.3.2 EVMs are intended solely for use by technically qualified, professional electronics experts who are familiar with the dangers and application risks associated with handling electrical mechanical components, systems, and subsystems. User assumes all responsibility and liability for proper and safe handling and use of the EVM by User or its employees, affiliates, contractors or designees. User assumes all responsibility and liability to ensure that any interfaces (electronic and/or mechanical) between the EVM and any human body are designed with suitable isolation and means to safely limit accessible leakage currents to minimize the risk of electrical shock hazard. User assumes all responsibility and liability for any improper or unsafe handling or use of the EVM by User or its employees, affiliates, contractors or designees.

4.4 User assumes all responsibility and liability to determine whether the EVM is subject to any applicable international, federal, state, or local laws and regulations related to User's handling and use of the EVM and, if applicable, User assumes all responsibility and liability for compliance in all respects with such laws and regulations. User assumes all responsibility and liability for proper disposal and recycling of the EVM consistent with all applicable international, federal, state, and local requirements.

5. *Accuracy of Information:* To the extent TI provides information on the availability and function of EVMs, TI attempts to be as accurate as possible. However, TI does not warrant the accuracy of EVM descriptions, EVM availability or other information on its websites as accurate, complete, reliable, current, or error-free.

6. *Disclaimers:*
- 6.1 EXCEPT AS SET FORTH ABOVE, EVMS AND ANY WRITTEN DESIGN MATERIALS PROVIDED WITH THE EVM (AND THE DESIGN OF THE EVM ITSELF) ARE PROVIDED "AS IS" AND "WITH ALL FAULTS." TI DISCLAIMS ALL OTHER WARRANTIES, EXPRESS OR IMPLIED, REGARDING SUCH ITEMS, INCLUDING BUT NOT LIMITED TO ANY IMPLIED WARRANTIES OF MERCHANTABILITY OR FITNESS FOR A PARTICULAR PURPOSE OR NON-INFRINGEMENT OF ANY THIRD PARTY PATENTS, COPYRIGHTS, TRADE SECRETS OR OTHER INTELLECTUAL PROPERTY RIGHTS.
- 6.2 EXCEPT FOR THE LIMITED RIGHT TO USE THE EVM SET FORTH HEREIN, NOTHING IN THESE TERMS AND CONDITIONS SHALL BE CONSTRUED AS GRANTING OR CONFERRING ANY RIGHTS BY LICENSE, PATENT, OR ANY OTHER INDUSTRIAL OR INTELLECTUAL PROPERTY RIGHT OF TI, ITS SUPPLIERS/LICENSORS OR ANY OTHER THIRD PARTY, TO USE THE EVM IN ANY FINISHED END-USER OR READY-TO-USE FINAL PRODUCT, OR FOR ANY INVENTION, DISCOVERY OR IMPROVEMENT MADE, CONCEIVED OR ACQUIRED PRIOR TO OR AFTER DELIVERY OF THE EVM.
7. *USER'S INDEMNITY OBLIGATIONS AND REPRESENTATIONS.* USER WILL DEFEND, INDEMNIFY AND HOLD TI, ITS LICENSORS AND THEIR REPRESENTATIVES HARMLESS FROM AND AGAINST ANY AND ALL CLAIMS, DAMAGES, LOSSES, EXPENSES, COSTS AND LIABILITIES (COLLECTIVELY, "CLAIMS") ARISING OUT OF OR IN CONNECTION WITH ANY HANDLING OR USE OF THE EVM THAT IS NOT IN ACCORDANCE WITH THESE TERMS AND CONDITIONS. THIS OBLIGATION SHALL APPLY WHETHER CLAIMS ARISE UNDER STATUTE, REGULATION, OR THE LAW OF TORT, CONTRACT OR ANY OTHER LEGAL THEORY, AND EVEN IF THE EVM FAILS TO PERFORM AS DESCRIBED OR EXPECTED.
8. *Limitations on Damages and Liability:*
- 8.1 *General Limitations.* IN NO EVENT SHALL TI BE LIABLE FOR ANY SPECIAL, COLLATERAL, INDIRECT, PUNITIVE, INCIDENTAL, CONSEQUENTIAL, OR EXEMPLARY DAMAGES IN CONNECTION WITH OR ARISING OUT OF THESE TERMS AND CONDITIONS OR THE USE OF THE EVMS PROVIDED HEREUNDER, REGARDLESS OF WHETHER TI HAS BEEN ADVISED OF THE POSSIBILITY OF SUCH DAMAGES. EXCLUDED DAMAGES INCLUDE, BUT ARE NOT LIMITED TO, COST OF REMOVAL OR REINSTALLATION, ANCILLARY COSTS TO THE PROCUREMENT OF SUBSTITUTE GOODS OR SERVICES, RETESTING, OUTSIDE COMPUTER TIME, LABOR COSTS, LOSS OF GOODWILL, LOSS OF PROFITS, LOSS OF SAVINGS, LOSS OF USE, LOSS OF DATA, OR BUSINESS INTERRUPTION. NO CLAIM, SUIT OR ACTION SHALL BE BROUGHT AGAINST TI MORE THAN ONE YEAR AFTER THE RELATED CAUSE OF ACTION HAS OCCURRED.
- 8.2 *Specific Limitations.* IN NO EVENT SHALL TI'S AGGREGATE LIABILITY FROM ANY WARRANTY OR OTHER OBLIGATION ARISING OUT OF OR IN CONNECTION WITH THESE TERMS AND CONDITIONS, OR ANY USE OF ANY TI EVM PROVIDED HEREUNDER, EXCEED THE TOTAL AMOUNT PAID TO TI FOR THE PARTICULAR UNITS SOLD UNDER THESE TERMS AND CONDITIONS WITH RESPECT TO WHICH LOSSES OR DAMAGES ARE CLAIMED. THE EXISTENCE OF MORE THAN ONE CLAIM AGAINST THE PARTICULAR UNITS SOLD TO USER UNDER THESE TERMS AND CONDITIONS SHALL NOT ENLARGE OR EXTEND THIS LIMIT.
9. *Return Policy.* Except as otherwise provided, TI does not offer any refunds, returns, or exchanges. Furthermore, no return of EVM(s) will be accepted if the package has been opened and no return of the EVM(s) will be accepted if they are damaged or otherwise not in a resalable condition. If User feels it has been incorrectly charged for the EVM(s) it ordered or that delivery violates the applicable order, User should contact TI. All refunds will be made in full within thirty (30) working days from the return of the components(s), excluding any postage or packaging costs.
10. *Governing Law:* These terms and conditions shall be governed by and interpreted in accordance with the laws of the State of Texas, without reference to conflict-of-laws principles. User agrees that non-exclusive jurisdiction for any dispute arising out of or relating to these terms and conditions lies within courts located in the State of Texas and consents to venue in Dallas County, Texas. Notwithstanding the foregoing, any judgment may be enforced in any United States or foreign court, and TI may seek injunctive relief in any United States or foreign court.

Mailing Address: Texas Instruments, Post Office Box 655303, Dallas, Texas 75265  
Copyright © 2015, Texas Instruments Incorporated

## IMPORTANT NOTICE

Texas Instruments Incorporated and its subsidiaries (TI) reserve the right to make corrections, enhancements, improvements and other changes to its semiconductor products and services per JESD46, latest issue, and to discontinue any product or service per JESD48, latest issue. Buyers should obtain the latest relevant information before placing orders and should verify that such information is current and complete. All semiconductor products (also referred to herein as "components") are sold subject to TI's terms and conditions of sale supplied at the time of order acknowledgment.

TI warrants performance of its components to the specifications applicable at the time of sale, in accordance with the warranty in TI's terms and conditions of sale of semiconductor products. Testing and other quality control techniques are used to the extent TI deems necessary to support this warranty. Except where mandated by applicable law, testing of all parameters of each component is not necessarily performed.

TI assumes no liability for applications assistance or the design of Buyers' products. Buyers are responsible for their products and applications using TI components. To minimize the risks associated with Buyers' products and applications, Buyers should provide adequate design and operating safeguards.

TI does not warrant or represent that any license, either express or implied, is granted under any patent right, copyright, mask work right, or other intellectual property right relating to any combination, machine, or process in which TI components or services are used. Information published by TI regarding third-party products or services does not constitute a license to use such products or services or a warranty or endorsement thereof. Use of such information may require a license from a third party under the patents or other intellectual property of the third party, or a license from TI under the patents or other intellectual property of TI.

Reproduction of significant portions of TI information in TI data books or data sheets is permissible only if reproduction is without alteration and is accompanied by all associated warranties, conditions, limitations, and notices. TI is not responsible or liable for such altered documentation. Information of third parties may be subject to additional restrictions.

Resale of TI components or services with statements different from or beyond the parameters stated by TI for that component or service voids all express and any implied warranties for the associated TI component or service and is an unfair and deceptive business practice. TI is not responsible or liable for any such statements.

Buyer acknowledges and agrees that it is solely responsible for compliance with all legal, regulatory and safety-related requirements concerning its products, and any use of TI components in its applications, notwithstanding any applications-related information or support that may be provided by TI. Buyer represents and agrees that it has all the necessary expertise to create and implement safeguards which anticipate dangerous consequences of failures, monitor failures and their consequences, lessen the likelihood of failures that might cause harm and take appropriate remedial actions. Buyer will fully indemnify TI and its representatives against any damages arising out of the use of any TI components in safety-critical applications.

In some cases, TI components may be promoted specifically to facilitate safety-related applications. With such components, TI's goal is to help enable customers to design and create their own end-product solutions that meet applicable functional safety standards and requirements. Nonetheless, such components are subject to these terms.

No TI components are authorized for use in FDA Class III (or similar life-critical medical equipment) unless authorized officers of the parties have executed a special agreement specifically governing such use.

Only those TI components which TI has specifically designated as military grade or "enhanced plastic" are designed and intended for use in military/aerospace applications or environments. Buyer acknowledges and agrees that any military or aerospace use of TI components which have **not** been so designated is solely at the Buyer's risk, and that Buyer is solely responsible for compliance with all legal and regulatory requirements in connection with such use.

TI has specifically designated certain components as meeting ISO/TS16949 requirements, mainly for automotive use. In any case of use of non-designated products, TI will not be responsible for any failure to meet ISO/TS16949.

### Products

Audio	<a href="http://www.ti.com/audio">www.ti.com/audio</a>
Amplifiers	<a href="http://amplifier.ti.com">amplifier.ti.com</a>
Data Converters	<a href="http://dataconverter.ti.com">dataconverter.ti.com</a>
DLP® Products	<a href="http://www.dlp.com">www.dlp.com</a>
DSP	<a href="http://dsp.ti.com">dsp.ti.com</a>
Clocks and Timers	<a href="http://www.ti.com/clocks">www.ti.com/clocks</a>
Interface	<a href="http://interface.ti.com">interface.ti.com</a>
Logic	<a href="http://logic.ti.com">logic.ti.com</a>
Power Mgmt	<a href="http://power.ti.com">power.ti.com</a>
Microcontrollers	<a href="http://microcontroller.ti.com">microcontroller.ti.com</a>
RFID	<a href="http://www.ti-rfid.com">www.ti-rfid.com</a>
OMAP Applications Processors	<a href="http://www.ti.com/omap">www.ti.com/omap</a>
Wireless Connectivity	<a href="http://www.ti.com/wirelessconnectivity">www.ti.com/wirelessconnectivity</a>

### Applications

Automotive and Transportation	<a href="http://www.ti.com/automotive">www.ti.com/automotive</a>
Communications and Telecom	<a href="http://www.ti.com/communications">www.ti.com/communications</a>
Computers and Peripherals	<a href="http://www.ti.com/computers">www.ti.com/computers</a>
Consumer Electronics	<a href="http://www.ti.com/consumer-apps">www.ti.com/consumer-apps</a>
Energy and Lighting	<a href="http://www.ti.com/energy">www.ti.com/energy</a>
Industrial	<a href="http://www.ti.com/industrial">www.ti.com/industrial</a>
Medical	<a href="http://www.ti.com/medical">www.ti.com/medical</a>
Security	<a href="http://www.ti.com/security">www.ti.com/security</a>
Space, Avionics and Defense	<a href="http://www.ti.com/space-avionics-defense">www.ti.com/space-avionics-defense</a>
Video and Imaging	<a href="http://www.ti.com/video">www.ti.com/video</a>

### TI E2E Community

[e2e.ti.com](http://e2e.ti.com)