



**GARDTEC**

Part Number:

**SC100-W37**

Material: C1008 Steel  
Finish: Bright Nickel Chrome Plating  
Ring Diameter: 1.6mm  
Rib Diameter: 2.0mm  
Disc T=1.0mm  
General Tolerance Unless Noted:  $\pm 0.5$ mm  
Unit: mm  
RoHS/REACH Compliant

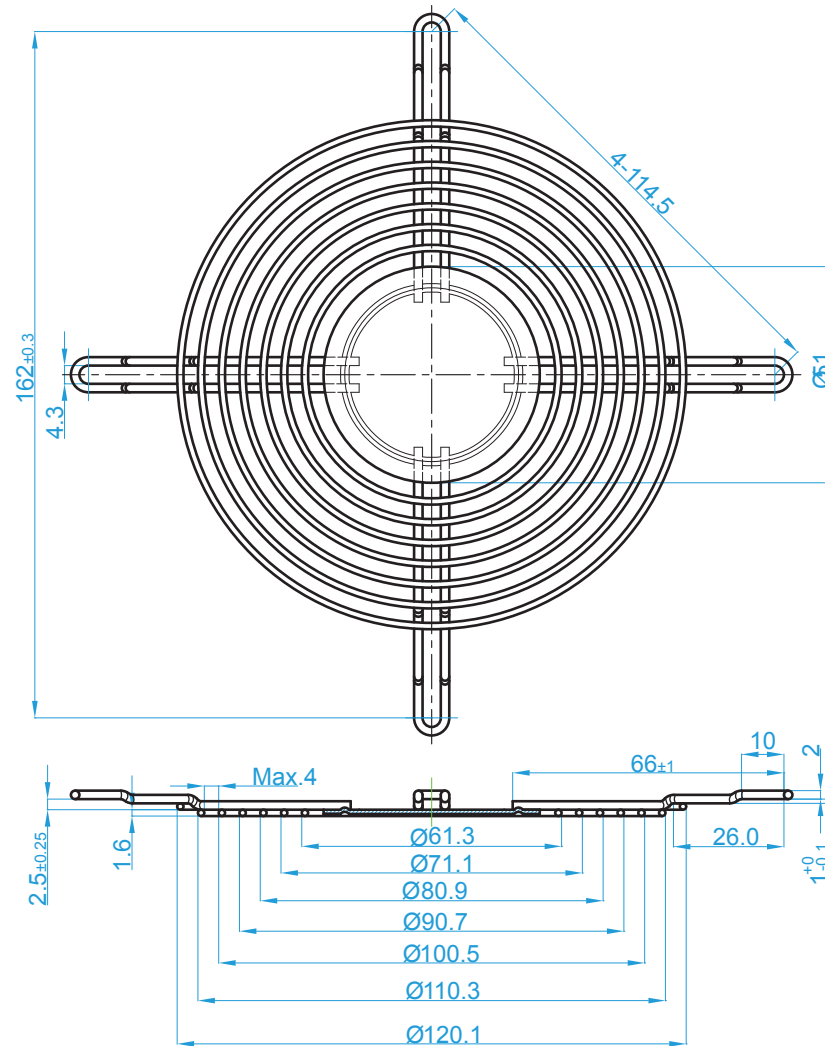

These drawings are the property of Gardtec, Inc and cannot be reproduced for or communicated to a third party without the express written permission of Gardtec, Inc.