

Vertical Launch Connectors

SMA, SMPM and SMP Compression Connectors

Introducing SMA, SMPM and SMP Male Vertical Launch Solderless PCB Compression Mount, in Microstrip and Stripline connectors with RF Performance up to 65 GHz. These connectors are screw-mount and solderless, allowing for quick and easy mounting and removal on PC boards. There are two versions for supporting both microstrip and stripline designs. The side groove part enables microstrip or grounded coplanar waveguide (GCPW) designs.

SMA maximum VSWR of 1.20 out to 26.5 GHz; Insertion loss of $0.12\sqrt{F}$ dB Max (F in GHz)

SMP maximum VSWR of 1.50 out to 40 GHz; Insertion loss of $0.12\sqrt{F}$ dB Max (F in GHz)

SMPM maximum VSWR of 1.50 out to 65 GHz; Insertion loss of $0.12\sqrt{F}$ dB Max (F in GHz)

The SMP and SMPM are built with a rugged design to accommodate both radial and axial misalignment, caused by shock and vibration in harsh environments. Available in Smooth Bore, Limited Detent and Full Detent versions to work with our bullet adapters. Intermateable to other industry connectors such as the GPO® and GPPPO®. Designed to conform to DSCC 94007, 94008 and MIL-STD-34.

Applications

- LAN Routers
- Base stations
- Satellite Communication Equipment
- Phased Array Radar systems
- Airborne Ground Radar
- MIMO
- Active Antennas



SMA Compression Connector, Microstrip

Part Number	Material	Impedance	Maximum Frequency	VSWR
141-0701-231	Stainless Steel Passivated	50 Ohms	DC - 26.5 GHz	1.20 Max

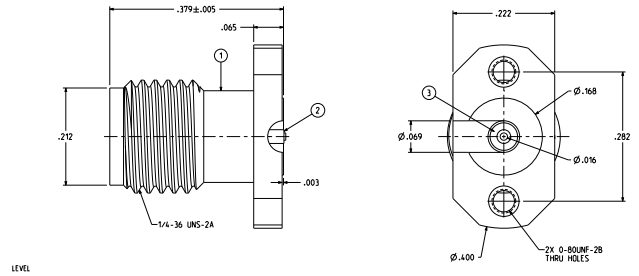

SMA Compression Connector, Stripline

Part Number	Material	Impedance	Maximum Frequency	VSWR
141-0701-241	Stainless Steel Passivated	50 Ohms	DC - 26.5 GHz	1.20 Max

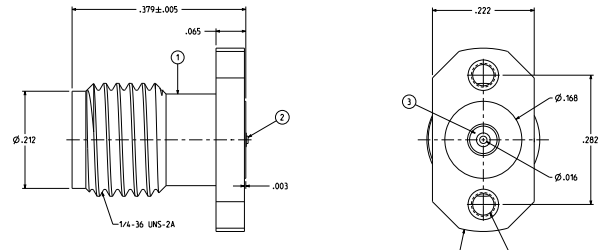

SMP Compression Connector, Microstrip

Part Number	Material	Impedance	Maximum Frequency	VSWR
127-0701-631	Gold-Plated	50 Ohms	DC - 40 GHz	1.5 Max

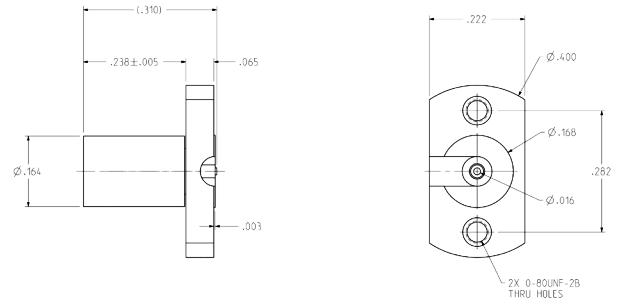

SMP Compression Connector, Stripline

Part Number	Material	Impedance	Maximum Frequency	VSWR
127-0701-641	Gold-Plated	50 Ohms	DC - 40 GHz	1.3 Max

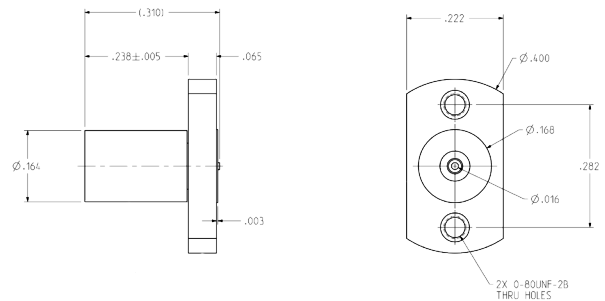

Note:

Per the drawing, vertical launch connectors can be mounted with screw type of 08 UNF-28. (Screws to be purchased separately).



SMPM Compression Connector, Microstrip

Part Number	Material	Impedance	Maximum Frequency	VSWR
125-0701-241	Gold-Plated	50 Ohms	DC - 65 GHz	1.4 Typical from DC - 50 GHz

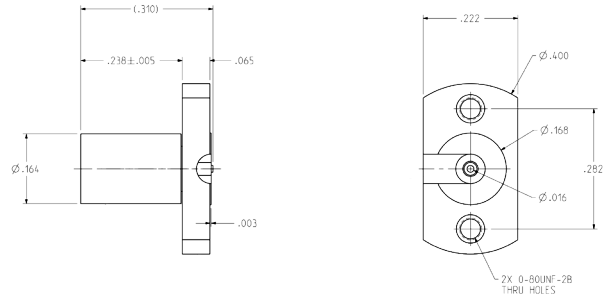

SMPM Compression Connector, Stripline

Part Number	Material	Impedance	Maximum Frequency	VSWR
125-0701-251	Gold-Plated	50 Ohms	DC - 65 GHz	1.4 Typical from DC - 50 GHz

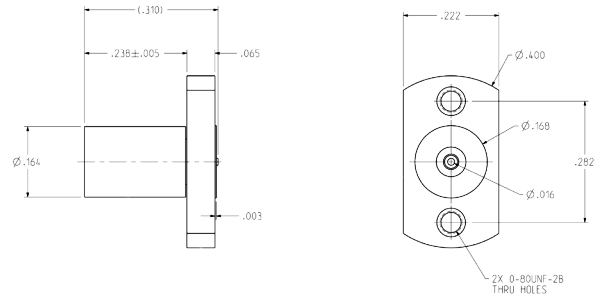
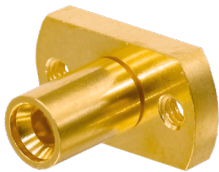

Note:

Per the drawing, vertical launch connectors can be mounted with screw type of 08 UNF-28. (Screws to be purchased separately).



Asia Pacific
+86 21 5442 7668
ccs.asia.sales@as.cinch.com

Europe, Middle East & Africa
+44 (0) 1245 342060
cinchconnectivity@eu.cinch.com

North America
+1 507 833 8822
ccsorders@us.cinch.com

[belfuse.com/cinch](https://www.belfuse.com/cinch)