



MICROWAVE

Gain Equalizer

EQY-5-24+

50Ω 5dB DC to 20 GHz

THE BIG DEAL

- Excellent Return Loss, 20dB typ.
- Wide bandwidth, DC to 20 GHz
- Small Size, 2 mm x 2 mm
- 5.1 dB Slope

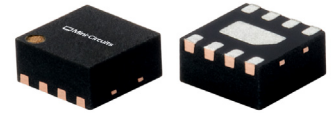

Generic photo used for illustration purposes only

CASE STYLE: MC1631-1

APPLICATIONS

- Fixed Satellite
- Mobile
- Radio location
- Space research

+RoHS Compliant

The +Suffix identifies RoHS Compliance. See our website for methodologies and qualifications

PRODUCT OVERVIEW

EQY-5-24+ is an absorptive Gain Equalizer fabricated using highly repetitive GaAs IPD MMIC process incorporating resistors, capacitors and inductors having negative insertion loss slope. EQY-5-24+ has a nominal attenuation slope of 5.1 dB and is packaged in tiny 2 x 2 mm, 8-Lead MCLP™ package.

KEY FEATURES

| Feature | Advantages |
|---|--|
| Negative Insertion Loss Slope vs. Frequency | Useful for compensating negative gain slope of amplifiers, receivers, transmitters to achieve flat gain versus frequency. |
| Wide range of values 0,2,3,5,6,8,10,12 dB | Enables circuit designer to change nominal insertion loss values without motherboard redesign making the EQY-XX-24+ Series ideal for select at test application. |
| Wideband operation, DC to 20 GHz | Supports a wide array of applications including wireless cellular, microwave communications, satellite, defense and aerospace, medical broadband and optic applications. |
| Excellent Power Handling Capability | Enables its use at the output of a variety of amplifiers |
| Small Size and simple to use (2 mm x 2 mm) | As a single chip solution, the EQY-XX-24+ Series occupies less board space than a lumped element approach, minimizes component count and ensures repeatable performance over wide frequency range. |

*GaAs IPD (Gallium Arsenide Integrated Passive Device)

REV. A
ECO-014561
EQY-5-24+
MCL NY
220817





MICROWAVE

Gain Equalizer

EQY-5-24+

50Ω 5dB DC to 20 GHz

ELECTRICAL SPECIFICATIONS¹ AT 25°C, 50Ω, UNLESS OTHERWISE NOTED.

| Parameter | Condition (GHz) | Min. | Typ. | Max. | Units |
|-----------------|-----------------|------|------|------|-------|
| Frequency Range | | DC | | 20 | GHz |
| Insertion Loss | 0.01 | 5.5 | 5.8 | 6.1 | dB |
| | 5 | — | 5.1 | — | |
| | 10 | — | 3.3 | — | |
| | 18 | 0.7 | 1.0 | 1.3 | |
| | 20 | — | 0.7 | — | |
| VSWR | 0.01 - 5 | — | 1.13 | — | :1 |
| | 5 - 10 | — | 1.24 | — | |
| | 10 - 18 | — | 1.29 | — | |
| | 18 - 20 | — | 1.06 | — | |

1. Measured on Mini-Circuits Characterization Test Board TB-EQY-5-24+. See Characterization Test Circuit (Fig. 1)

MAXIMUM RATINGS²

| Parameter | Ratings |
|-----------------------------|----------------|
| Operating Case Temperature | -55°C to 105°C |
| Storage Temperature | -65°C to 150°C |
| RF Input Power ³ | +34 dBm |

2. Permanent damage may occur if any of these limits are exceeded.

3. Derates linearly to +32 dBm at 105°C



MICROWAVE

Gain Equalizer

EQY-5-24+

50Ω 5dB DC to 20 GHz

SIMPLIFIED SCHEMATIC & PAD DESCRIPTION

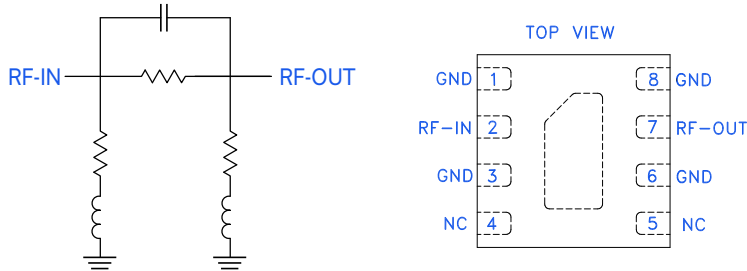

| Function | Pad Number | Description |
|----------|------------------|---|
| RF-IN | 2 | RF-Input pad |
| RF-OUT | 7 | RF-Output pad |
| GND | 1,3,6,8 & Paddle | Ground |
| NC | 4,5 | No connection, connected to ground externally |

CHARACTERIZATION TEST CIRCUIT

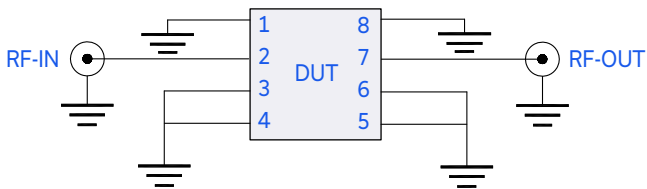
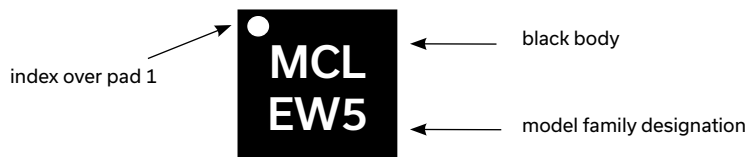

Fig 1. Block Diagram of Test Circuit used for characterization. Test Board TB-EQY-5-24+ Conditions: Attenuation & Return Loss Pin=0 dBm

PRODUCT MARKING



Marking may contain other features or characters for internal lot control



MICROWAVE

Gain Equalizer

EQY-5-24+

50Ω 5dB DC to 20 GHz

TYPICAL PERFORMANCE DATA AT 25°C

| Frequency (MHz) | Insertion Loss (dB) | Input VSWR (:1) | Output VSWR (:1) |
|-----------------|---------------------|-----------------|------------------|
| 10 | 5.74 | 1.13 | 1.13 |
| 1000 | 5.72 | 1.11 | 1.10 |
| 2000 | 5.62 | 1.10 | 1.09 |
| 4000 | 5.25 | 1.13 | 1.11 |
| 5000 | 5.04 | 1.20 | 1.19 |
| 6000 | 4.79 | 1.26 | 1.27 |
| 8000 | 4.09 | 1.23 | 1.28 |
| 10000 | 3.23 | 1.18 | 1.18 |
| 12000 | 2.68 | 1.41 | 1.41 |
| 14000 | 2.18 | 1.44 | 1.49 |
| 15000 | 1.87 | 1.38 | 1.42 |
| 16000 | 1.55 | 1.28 | 1.29 |
| 17000 | 1.25 | 1.16 | 1.16 |
| 18000 | 1.01 | 1.08 | 1.08 |
| 19000 | 0.82 | 1.05 | 1.04 |
| 20000 | 0.68 | 1.05 | 1.02 |

EQY-5-24+
INSERTION LOSS

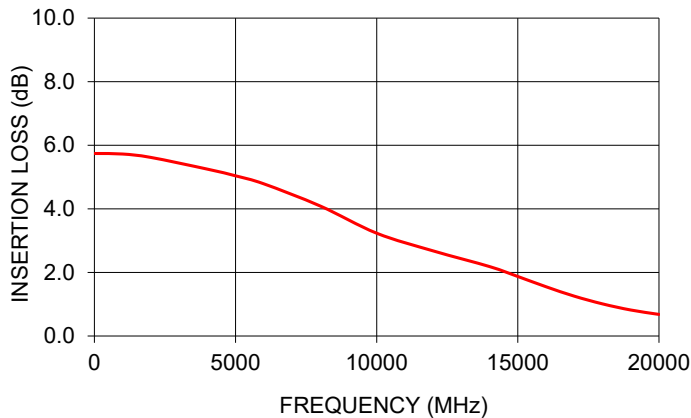

EQY-5-24+
VSWR

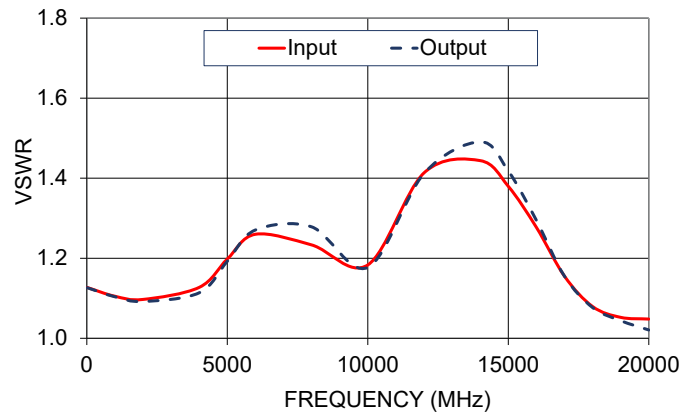



MICROWAVE

Gain Equalizer

EQY-5-24+

50Ω 5dB DC to 20 GHz

ADDITIONAL DETAILED TECHNICAL INFORMATION IS AVAILABLE ON OUR DASH BOARD. TO ACCESS [CLICK HERE](#)

| | |
|--|---|
| Performance Data | Data Table |
| | Swept Graphs |
| Case Style | MC1631-1 Plastic package, Lead finish: Matte-tin |
| Tape & Reel Standard quantities available on reel | F66 7" reels with 20, 50, 100, 200, 500,1K or 2K devices |
| Suggested Layout for PCB Design | PL-618 |
| Evaluation Board | TB-EQY-5-24+ |
| Environmental Ratings | ENV08T1 |

ESD RATING

Human Body Model (HBM): Class 2 (Pass 2000V) in accordance with ANSI/ESD STM 5.1 - 2001 Machine.

MSL TEST FLOW CHART

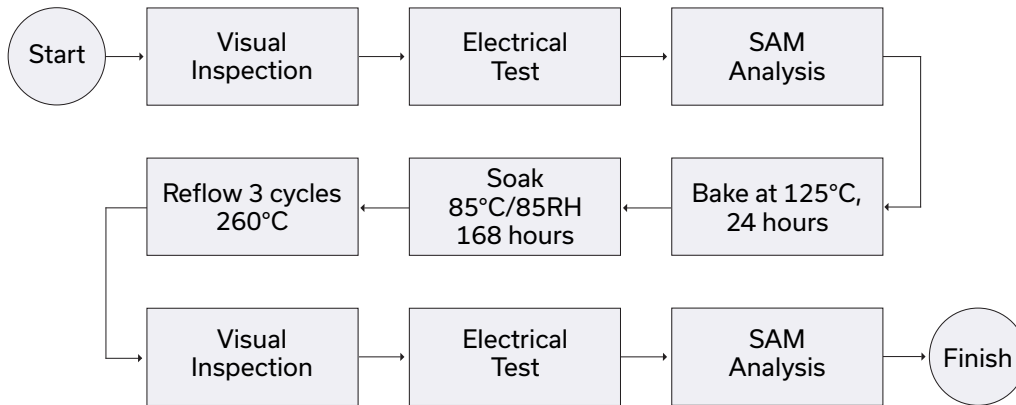

NOTES

- A. Performance and quality attributes and conditions not expressly stated in this specification document are intended to be excluded and do not form a part of this specification document.
- B. Electrical specifications and performance data contained in this specification document are based on Mini-Circuit's applicable established test performance criteria and measurement instructions.
- C. The parts covered by this specification document are subject to Mini-Circuits standard limited warranty and terms and conditions (collectively, "Standard Terms"); Purchasers of this part are entitled to the rights and benefits contained therein. For a full statement of the standard terms and the exclusive rights and remedies thereunder, please visit Mini-Circuits' website at www.minicircuits.com/terms/viewterm.html

