

# AK1-Y Series

## Axial Leaded – 1kA

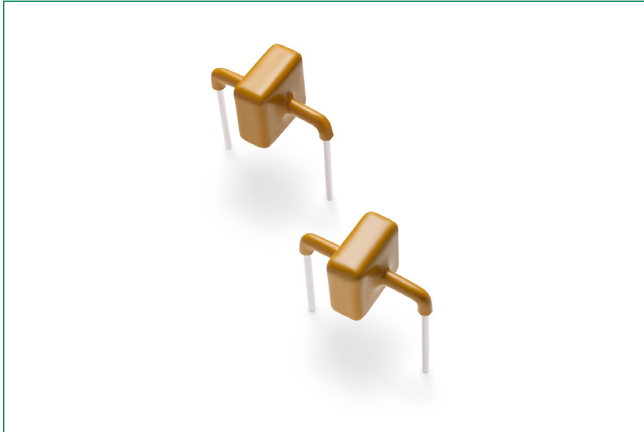

### Agency Recognitions

Agency	Agency File Number
	E128662

### Maximum Ratings and Thermal Characteristics

( $T_A=25^{\circ}\text{C}$  unless otherwise noted)

Parameter	Symbol	Value	Unit
Operating Storage Temperature Range	$T_{\text{STG}}$	-55 to 150	$^{\circ}\text{C}$
Operating Junction Temperature Range	$T_J$	-55 to 125	$^{\circ}\text{C}$
Current Rating <sup>1</sup>	$I_{\text{PP}}$	1	kA

**Note:**

1. Rated  $I_{\text{PP}}$  measured with 8/20 $\mu\text{s}$  pulse.

### Functional Diagram

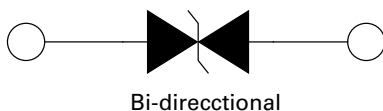

## Descriptions

The AK1-Y series of high power TVS diode is specially designed for meeting severe surge test environment of both AC and DC line protection applications. It features a very fast response and ultra low clamping characteristics as compared to MOVs (Metal Oxide Varistors). These AK components can be connected in series and / or parallel to create a very high surge current protection solution.

## Features & Benefits

- Recognized to UL 497B as an Isolated Loop Circuit Protector
- Both reflow and wave soldering capable
- Very low clamping voltage
- Ultra compact: less than one-tenth the size of traditional discrete solutions
- Sharp breakdown voltage
- Low slope resistance
- Bi-directional
- IEC 61000-4-2 ESD 15kV(Air), 8kV (Contact)
- Symmetric in leads width for easier soldering during assembly.
- ESD protection of data lines in accordance with IEC 61000-4-2
- EFT protection of data lines in accordance with IEC 61000-4-4
- UL Recognized compound meeting flammability rating V-0
- Halogen-free and RoHS compliant
- Glass passivated junction
- Pb-free E4 means 2nd level interconnect is Pb-free and the terminal finish material is silver

### Electrical Characteristics ( $T_A=25^{\circ}\text{C}$ unless otherwise noted)

Part Numbers	Part Marking	Standoff Voltage ( $V_{\text{SO}}$ ) Volts	Max. Reverse Leakage ( $I_{\text{R}}$ ) @ $V_{\text{SO}}$ $\mu\text{A}$	Typical $I_{\text{R}}$ @ $85^{\circ}\text{C}$ ( $\mu\text{A}$ )	Reverse Breakdown Voltage ( $V_{\text{BR}}$ ) @ $I_{\text{T}}$		Test Current $I_{\text{T}}$ (mA)	Max. Clamping Voltage $V_{\text{CL}}$ @ $I_{\text{PP}}$ Peak Pulse Current ( $I_{\text{PP}}$ ) (Note 1)		Max. Temp Coefficient OF $V_{\text{BR}}$ (%/ $^{\circ}\text{C}$ )	Max. Capacitance 0 Bias 10kHz (nF)	Agency Approval
					Min Volts	Max Volts		$V_{\text{CL}}$ Volts	$I_{\text{PP}}$ Amps			
AK1-076C-Y	1-076C	76	10	15	85	95	10	140	1,000	0.1	8.5	X
AK1-380C-Y	1-380C	380	10	15	401	443	10	570	1,000	0.1	2.0	X
AK1-430C-Y	1-430C	430	10	15	440	490	10	625	1,000	0.1	2.0	X

**Note:** Using 8/20 $\mu\text{s}$  wave shape as defined in IEC 61000-4-5.

# AK1-Y Series

## Axial Leaded – 1kA

### Ratings and Characteristic Curves ( $T_A=25^\circ\text{C}$ unless otherwise noted)

**Figure 1:**  
Peak Power Derating

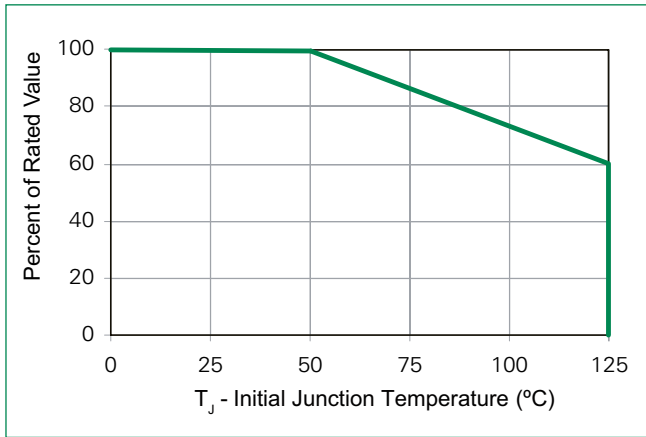

**Figure 2:**  
Typical Peak Pulse Power Rating Curve

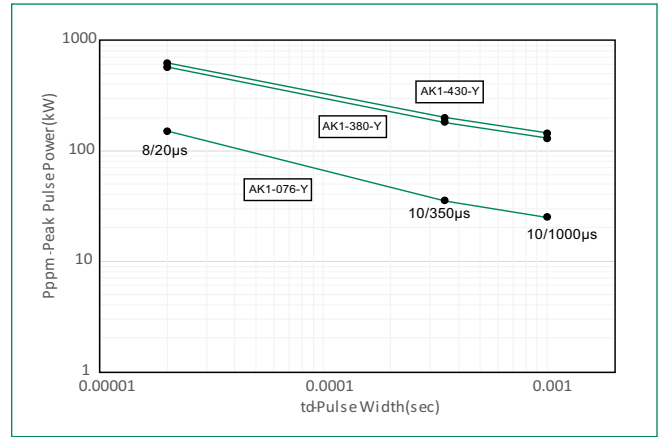

**Figure 3:**  
Typical VBR Vs Junction Temperature

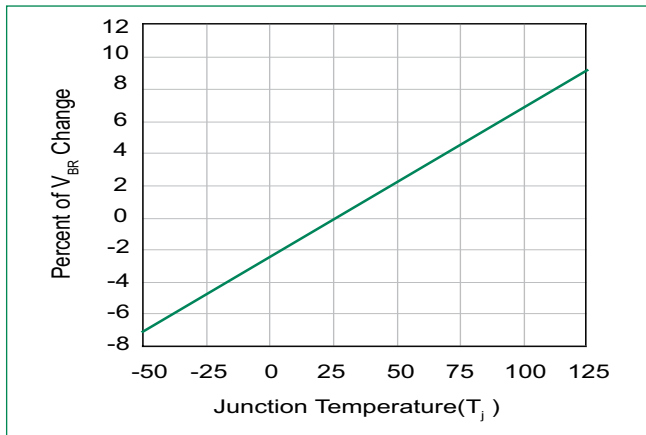

**Figure 4:**  
Pulse Waveform

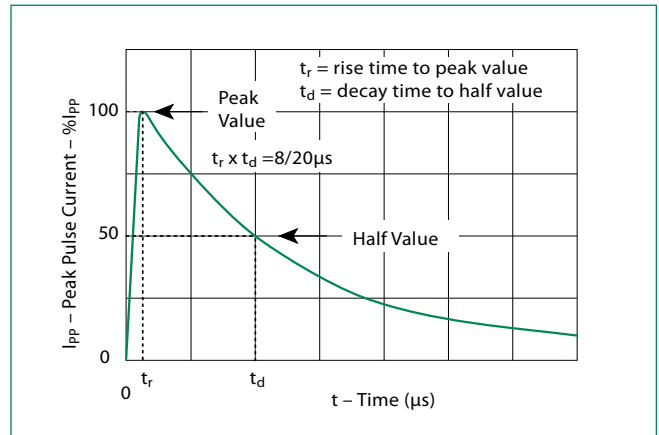

# AK1-Y Series

## Axial Leaded – 1kA

### Soldering Parameters

<b>Reflow Condition</b>		Lead-free assembly
<b>Pre Heat</b>	- Temperature Min ( $T_{s(min)}$ )	150°C
	- Temperature Max ( $T_{s(max)}$ )	200°C
	- Time (min to max) ( $t_s$ )	60 – 120 secs
<b>Average ramp up rate (Liquidus Temp (<math>T_L</math>) to peak)</b>		3°C/second max
<b><math>T_{s(max)}</math> to <math>T_A</math> - Ramp-up Rate</b>		3°C/second max
<b>Reflow</b>	- Temperature ( $T_L$ ) (Liquidus)	217°C
	- Time (min to max) ( $t_r$ )	60 – 150 seconds
<b>Peak Temperature (<math>T_p</math>)</b>		260 <sup>+0/-5</sup> °C
<b>Time within 5°C of actual peak Temperature (<math>t_p</math>)</b>		30 seconds
<b>Ramp-down Rate</b>		6°C/second max
<b>Time 25°C to peak Temperature (<math>T_p</math>)</b>		8 minutes Max.
<b>Do not exceed</b>		260°C

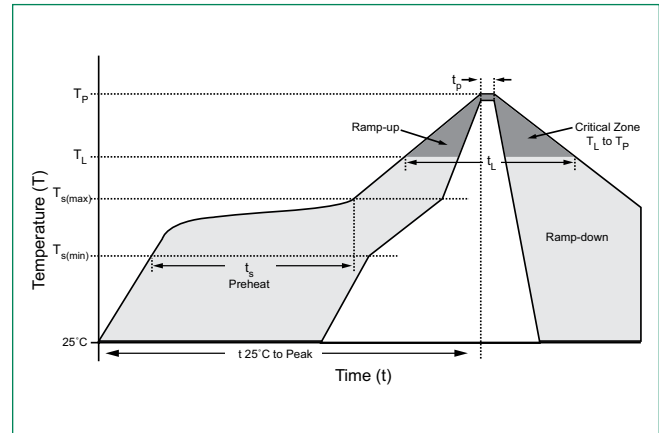

### Flow Soldering (Solder Dipping)

<b>Reflow Condition</b>		Lead-free assembly
<b>Pre Heat</b>	- Temperature Min ( $T_{s(min)}$ )	140°C
	- Temperature Max ( $T_{s(max)}$ )	160°C
	- Time to Pre-Heat Temp	60 – 150 secs
<b>Average ramp up rate to Pre-Heat Temp</b>		5°C/second max
<b>Peak Temperature (<math>T_p</math>)</b>		260 <sup>+0/-5</sup> °C
<b>Average ramp up rate (pre-heat to <math>T_p</math>)</b>		5°C/second max
<b>Time within actual peak Temperature Max</b>		6 seconds
<b>Ramp-down Rate</b>		5°C/second max

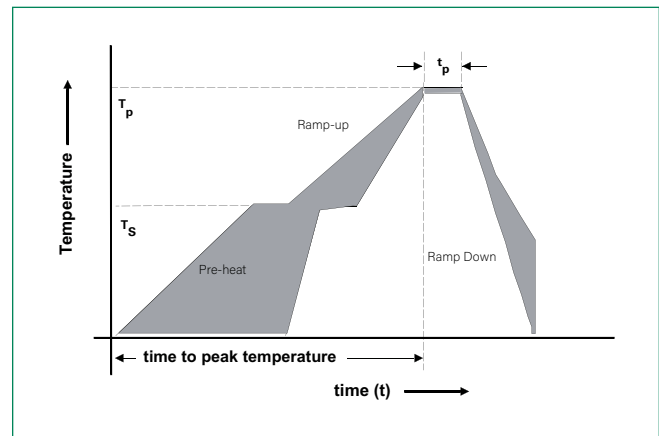

### Physical Specifications

<b>Weight</b>	Contact manufacturer
<b>Case</b>	UL Recognized compound meeting flammability rating V-0
<b>Terminal</b>	Silver plated leads, solderable per MIL-STD-750 Method 2026

# AK1-Y Series

## Axial Leaded – 1kA

### Dimensions

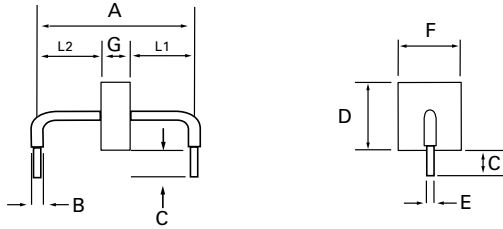

Dimensions	Inches	Millimeters
<b>A</b>	0.950 +/- 0.040	24.15 +/- 1.00
<b>B</b>	0.095 +/- 0.024	2.4 +/- 0.60
<b>C</b>	0.236 +/- 0.039	6.00 +/- 1.00
<b>D</b>	0.570 max.	14.48 max.
<b>E</b>	0.050 +/- 0.002	1.270 +/- 0.05
<b>F</b>	0.500 max.	12.70 max.
<b>G-076C-Y</b>	0.096 +/- 0.040	2.44 +/- 1.00
<b>G-380C-Y/ 430C-Y</b>	0.220 +/- 0.040	5.60 +/- 1 mm
<b>L1/L2</b>	L1= L2 tolerance +/- 0.04 inch (1.0 mm)	

### Packing Options

Part Number	Component Package	Quantity	Packaging Option
AK1-XXXX-Y	AK Package	56pcs/Box	Bulk
AK1-XXXX-Y12	AK Package	12pcs/Box	Bulk

### Part Numbering System

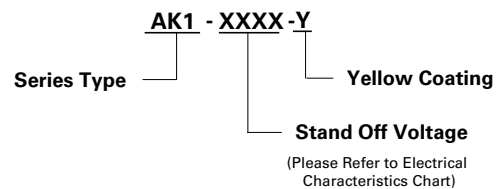

### Part Marking System

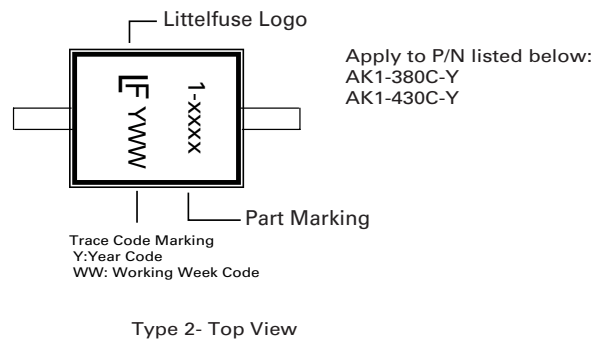
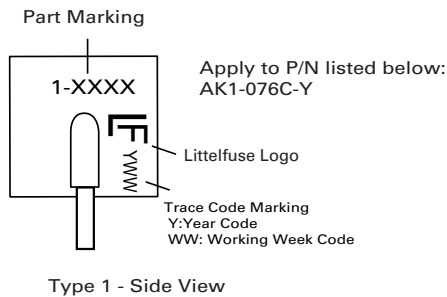

**Disclaimer Notice** - Information furnished is believed to be accurate and reliable. However, users should independently evaluate the suitability of and test each product selected for their own applications. Littelfuse products are not designed for, and may not be used in, all applications. Read complete Disclaimer Notice at <http://www.littelfuse.com/disclaimer-electronics>.