

NOTES:

1. Material : Music Wire
2. Finish : Glod Irridite
3. Ends : Closed
4. Total Coils : 10.000
5. Sugg. Max. Deflection : 0.360 (in)
6. Sugg. Max. Load : 2.300 (lbs)
7. All Drawing Dimensions are in Inches [mm]



\varnothing 0.030
 [0,76]
 WIRE DIA



1.910
 [48,51]
 LENGTH

\varnothing 0.500
 [12,70]
 O.D

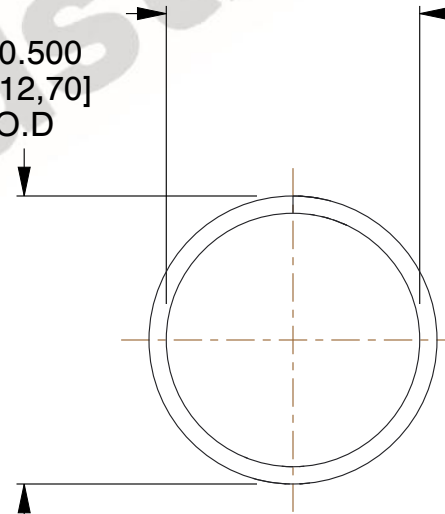

\varnothing 0.440
 [11,18]
 I.D

| COMPONENT | | SPRINGS | |
|---|--|---------|-----------|
| 11772 COMPRESSION SPRINGS | | UNIT | INCH [mm] |
| | | SHEET | 1 of 1 |
| | | | |