

# NLAS325

## Dual SPST Analog Switch, Low Voltage, Single Supply

The NLAS325 is a dual SPST (Single Pole, Single Throw) switch, similar to 1/2 a standard 4066. The device permits the independent selection of 2 analog/digital signals. Available in the Ultra-Small 8 package.

The use of advanced 0.6  $\mu$  CMOS process, improves the  $R_{ON}$  resistance considerably compared to older higher voltage technologies.

### Features

- On Resistance is 20  $\Omega$  Typical at 5.0 V
- Matching is < 1.0  $\Omega$  Between Sections
- 2.0–6.0 V Operating Range
- Ultra Low < 5.0 pC Charge Injection
- Ultra Low Leakage < 1.0 nA at 5.0 V, 25°C
- Wide Bandwidth > 200 MHz, –3.0 dB
- 2000 V ESD (HBM)
- $R_{ON}$  Flatness  $\pm 6.0 \Omega$  at 5.0 V
- Independent Enables; One Positive, One Negative
- These Devices are Pb-Free, Halogen Free/BFR Free and are RoHS Compliant

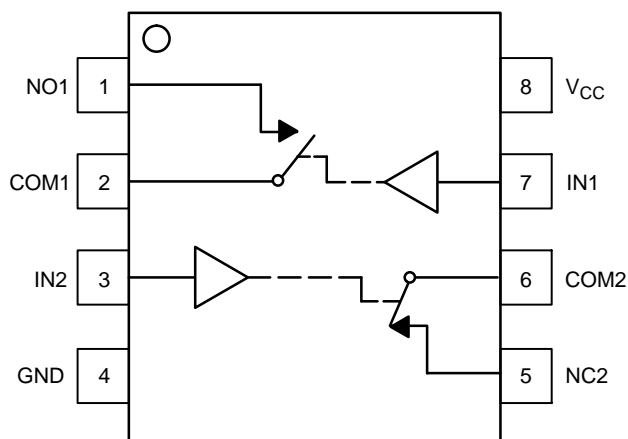

Figure 1. Pinout



**ON Semiconductor®**

[www.onsemi.com](http://www.onsemi.com)

### MARKING DIAGRAM



A9 = Device Code  
M = Date Code\*  
▪ = Pb-Free Package

(Note: Microdot may be in either location)

### PIN ASSIGNMENT

1	NO1
2	COM1
3	IN2
4	GND
5	NC2
6	COM2
7	IN1
8	V <sub>CC</sub>

### FUNCTION TABLE

On/Off Enable Input	Analog Switch 1	Analog Switch 2
L	Off	On
H	On	Off

### ORDERING INFORMATION

See detailed ordering and shipping information in the package dimensions section on page 9 of this data sheet.

**MAXIMUM RATINGS**

Symbol	Parameter	Value	Unit
V <sub>CC</sub>	DC Supply Voltage	-0.5 to +7.0	V
V <sub>I</sub>	DC Input Voltage	-0.5 to +7.0	V
V <sub>O</sub>	DC Output Voltage	-0.5 to +7.0	V
I <sub>IK</sub>	DC Input Diode Current V <sub>I</sub> < GND	-50	mA
I <sub>OK</sub>	DC Output Diode Current V <sub>O</sub> < GND	-50	mA
I <sub>O</sub>	DC Output Sink Current	±50	mA
I <sub>CC</sub>	DC Supply Current per Supply Pin	±100	mA
I <sub>GND</sub>	DC Ground Current per Ground Pin	±100	mA
T <sub>STG</sub>	Storage Temperature Range	-65 to +150	°C
T <sub>L</sub>	Lead Temperature, 1.0 mm from Case for 10 Seconds	260	°C
T <sub>J</sub>	Junction Temperature under Bias	+150	°C
θ <sub>JA</sub>	Thermal Resistance (Note 1)	250	°C/W
P <sub>D</sub>	Power Dissipation in Still Air at 85°C	250	mW
MSL	Moisture Sensitivity	Level 1	
F <sub>R</sub>	Flammability Rating Oxygen Index: 28 to 34	UL 94 V-0 @ 0.125 in	
V <sub>ESD</sub>	ESD Withstand Voltage Human Body Model (Note 2) Machine Model (Note 3) Charged Device Model (Note 4)	> 2000 > 200 N/A	V

Stresses exceeding those listed in the Maximum Ratings table may damage the device. If any of these limits are exceeded, device functionality should not be assumed, damage may occur and reliability may be affected.

1. Measured with minimum pad spacing on an FR4 board, using 10 mm-by-1 inch, 2-ounce copper trace with no air flow.
2. Tested to EIA/JESD22-A114-A.
3. Tested to EIA/JESD22-A115-A.
4. Tested to JESD22-C101-A.

**RECOMMENDED OPERATING CONDITIONS**

Symbol	Parameter	Min	Max	Unit
V <sub>CC</sub>	DC Supply Voltage	2.0	5.5	V
V <sub>IN</sub>	Digital Select Input Voltage	GND	5.5	V
V <sub>IS</sub>	Analog Input Voltage (NC, NO, COM)	GND	V <sub>CC</sub>	V
T <sub>A</sub>	Operating Temperature Range	-55	+125	°C
t <sub>r</sub> , t <sub>f</sub>	Input Rise or Fall Time, SELECT V <sub>CC</sub> = 3.3 V ± 0.3 V V <sub>CC</sub> = 5.0 V ± 0.5 V	0	100 20	ns/V

Functional operation above the stresses listed in the Recommended Operating Ranges is not implied. Extended exposure to stresses beyond the Recommended Operating Ranges limits may affect device reliability.

**DEVICE JUNCTION TEMPERATURE VERSUS TIME TO 0.1% BOND FAILURES**

Junction Temperature °C	Time, Hours	Time, Years
80	1,032,200	117.8
90	419,300	47.9
100	178,700	20.4
110	79,600	9.4
120	37,000	4.2
130	17,800	2.0
140	8,900	1.0

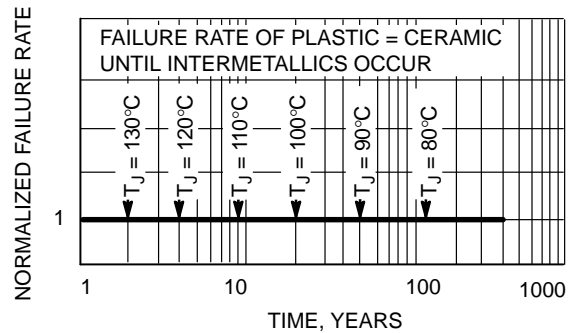

Figure 2. Failure Rate vs. Time Junction Temperature

# NLAS325

## DC CHARACTERISTICS – Digital Section (Voltages Referenced to GND)

Symbol	Parameter	Condition	V <sub>CC</sub>	Guaranteed Limit			Unit
				–55°C to 25°C	<85°C	<125°C	
V <sub>IH</sub>	Minimum High-Level Input Voltage, Select Inputs		2.0	1.5	1.5	1.5	V
			2.5	1.9	1.9	1.9	
			3.0	2.1	2.1	2.1	
			4.5	3.15	3.15	3.15	
			5.5	3.85	3.85	3.85	
V <sub>IL</sub>	Maximum Low-Level Input Voltage, Select Inputs		2.0	0.5	0.5	0.5	V
			2.5	0.6	0.6	0.6	
			3.0	0.9	0.9	0.9	
			4.5	1.35	1.35	1.35	
			5.5	1.65	1.65	1.65	
I <sub>IN</sub>	Maximum Input Leakage Current, Select Inputs	V <sub>IN</sub> = 5.5 V or GND	0 V to 5.5 V	±0.2	±2.0	±2.0	μA
I <sub>CC</sub>	Maximum Quiescent Supply Current	Select and V <sub>IS</sub> = V <sub>CC</sub> or GND	5.5	4.0	4.0	8.0	μA

## DC ELECTRICAL CHARACTERISTICS – Analog Section

Symbol	Parameter	Condition	V <sub>CC</sub>	Guaranteed Limit			Unit
				–55°C to 25°C	<85°C	<125°C	
R <sub>ON</sub>	Maximum “ON” Resistance (Figures 16 – 22)	V <sub>IN</sub> = V <sub>IL</sub> or V <sub>IH</sub> V <sub>IS</sub> = GND to V <sub>CC</sub>  I <sub>IN</sub>   ≤ 10 mA	2.5	85	95	105	Ω
			3.0	45	50	55	
			4.5	30	35	40	
			5.5	25	30	35	
R <sub>FLAT(ON)</sub>	ON Resistance Flatness (Figures 16 – 22)	V <sub>IN</sub> = V <sub>IL</sub> or V <sub>IH</sub>  I <sub>IN</sub>   ≤ 10 mA V <sub>IS</sub> = 1.0 V, 2.0 V, 3.5 V	4.5	4.0	4.0	5.0	Ω
I <sub>NC(OFF)</sub> I <sub>NO(OFF)</sub>	NO or NC Off Leakage Current (Figure 8)	V <sub>IN</sub> = V <sub>IL</sub> or V <sub>IH</sub> V <sub>NO</sub> or V <sub>NC</sub> = 1.0 V <sub>COM</sub> 4.5 V	5.5	1.0	10	100	nA
I <sub>COM(ON)</sub>	COM ON Leakage Current (Figure 8)	V <sub>IN</sub> = V <sub>IL</sub> or V <sub>IH</sub> V <sub>NO</sub> 1.0 V or 4.5 V with V <sub>NC</sub> floating or V <sub>NO</sub> 1.0 V or 4.5 V with V <sub>NO</sub> floating V <sub>COM</sub> = 1.0 V or 4.5 V	5.5	1.0	10	100	nA

# NLAS325

## AC ELECTRICAL CHARACTERISTICS (Input $t_r = t_f = 3.0$ ns)

Symbol	Parameter	Test Conditions	$V_{CC}$ (V)	$V_{IS}$ (V)	Guaranteed Maximum Limit						Unit	
					-55°C to 25°C			< 85°C		< 125°C		
					Min	Typ*	Max	Min	Max	Min		Max
$t_{ON}$	Turn-On Time (Figures 11 and 12)	$R_L = 300 \Omega$ , $C_L = 35$ pF (Figures 4 and 5)	2.5	2.0	5.0	23	35	5.0	38	5.0	41	ns
			3.0	2.0	5.0	16	24	5.0	27	5.0	30	
			4.5	3.0	2.0	11	16	2.0	19	2.0	22	
			5.5	3.0	2.0	9.0	14	2.0	17	2.0	20	
$t_{OFF}$	Turn-Off Time (Figures 11 and 12)	$R_L = 300 \Omega$ , $C_L = 35$ pF (Figures 4 and 5)	2.5	2.0	1.0	7.0	12	1.0	15	1.0	18	ns
			3.0	2.0	1.0	5.0	10	1.0	13	1.0	16	
			4.5	3.0	1.0	4.0	6.0	1.0	9.0	1.0	12	
			5.5	3.0	1.0	3.0	5.0	1.0	8.0	1.0	11	
$t_{BBM}$	Minimum Break-Before-Make Time	$V_{IS} = 3.0$ V (Figure 3) $R_L = 300 \Omega$ , $C_L = 35$ pF	2.5	2.0	1.0	12		1.0		1.0		ns
			3.0	2.0	1.0	11		1.0		1.0		
			4.5	3.0	1.0	6.0		1.0		1.0		
			5.5	3.0	1.0	5.0		1.0		1.0		

\*Typical Characteristics are at 25°C.

Symbol	Parameter	Typical @ 25, $V_{CC} = 5.0$ V		Unit
		Min	Max	
$C_{IN}$	Maximum Input Capacitance, Select Input		8.0	pF
$C_{NO}$ or $C_{NC}$	Analog I/O (switch off)		10	
$C_{COM}$	Common I/O (switch off)		10	
$C_{(ON)}$	Feedthrough (switch on)		20	

## ADDITIONAL APPLICATION CHARACTERISTICS (Voltages Referenced to GND Unless Noted)

Symbol	Parameter	Condition	$V_{CC}$ (V)	Typical	Unit
				25°C	
BW	Maximum On-Channel -3.0 dB Bandwidth or Minimum Frequency Response (Figure 10)	$V_{IN} = 0$ dBm $V_{IN}$ centered between $V_{CC}$ and GND (Figure 6)	3.0	145	MHz
			4.5	170	
			5.5	175	
$V_{ONL}$	Maximum Feedthrough On Loss	$V_{IN} = 0$ dBm @ 100 kHz to 50 MHz $V_{IN}$ centered between $V_{CC}$ and GND (Figure 6)	3.0	-2.0	dB
			4.5	-2.0	
			5.5	-2.0	
$V_{ISO}$	Off-Channel Isolation (Figure 9)	$f = 100$ kHz; $V_{IS} = 1.0$ V RMS $V_{IN}$ centered between $V_{CC}$ and GND (Figure 6)	3.0	-93	dB
			4.5	-93	
			5.5	-93	
Q	Charge Injection Select Input to Common I/O (Figure 14)	$V_{IN} = V_{CC}$ to GND, $F_{IS} = 20$ kHz $t_r = t_f = 3.0$ ns $R_{IS} = 0 \Omega$ , $C_L = 1000$ pF $Q = C_L * \Delta V_{OUT}$ (Figure 7)	3.0	1.5	pC
			5.5	3.0	
THD	Total Harmonic Distortion THD + Noise (Figure 13)	$F_{IS} = 20$ Hz to 100 kHz, $R_L = R_{gen} = 600 \Omega$ , $C_L = 50$ pF $V_{IS} = 5.0$ V <sub>PP</sub> sine wave	5.5	0.1	%
VCT	Channel-to-Channel Crosstalk	$f = 100$ kHz; $V_{IS} = 1.0$ V RMS $V_{IN}$ centered between $V_{CC}$ and GND (Figure 6)	5.5	-90	dB
			3.0	-90	

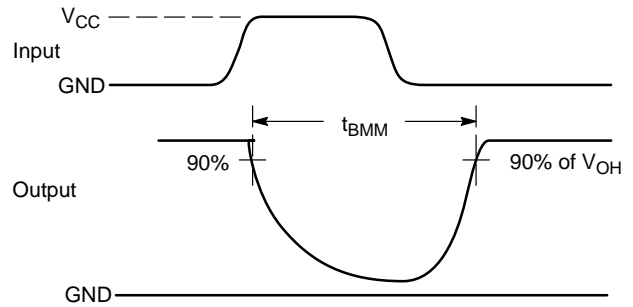
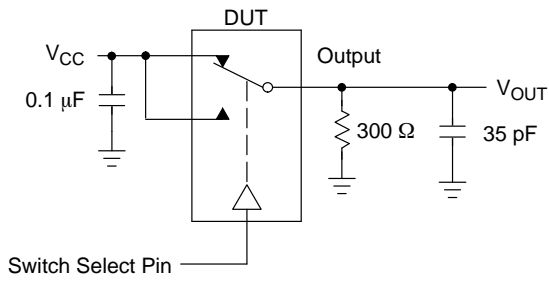

Figure 3.  $t_{BMM}$  (Time Break-Before-Make)

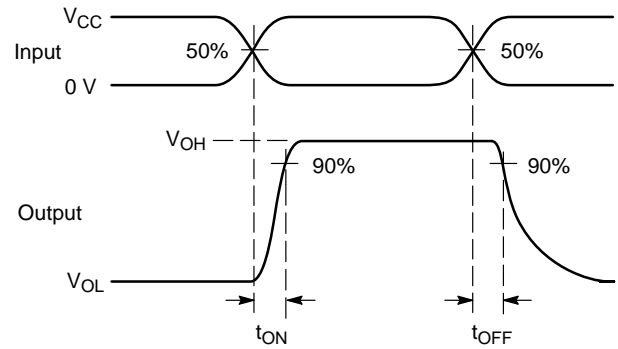
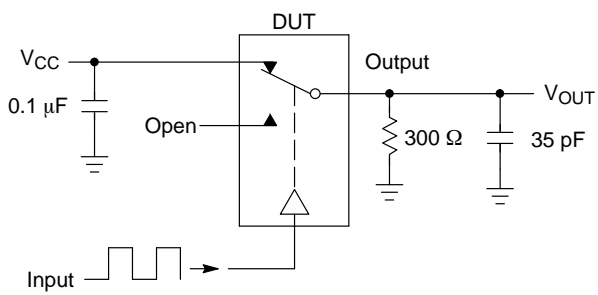

Figure 4.  $t_{ON}/t_{OFF}$

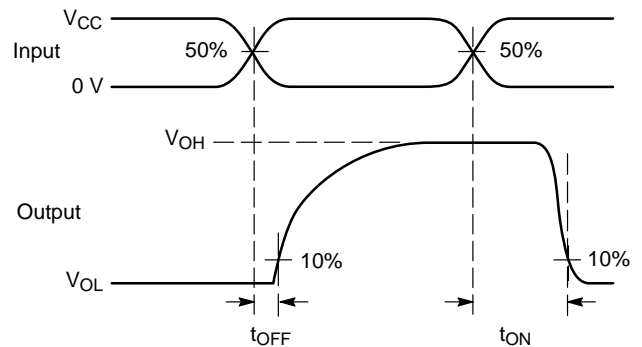
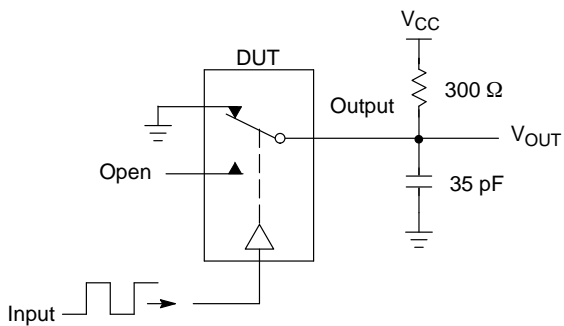
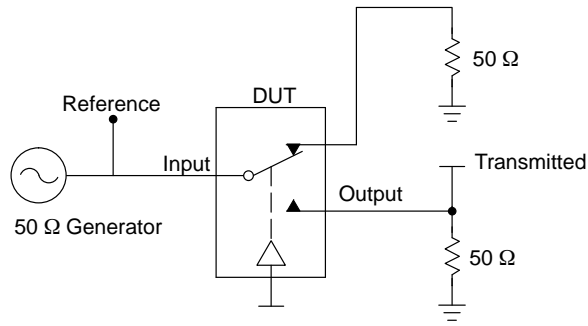

Figure 5.  $t_{ON}/t_{OFF}$

# NLAS325



Channel switch control/s test socket is normalized. Off isolation is measured across an off channel. On loss is the bandwidth of an On switch.  $V_{ISO}$ , Bandwidth and  $V_{ONL}$  are independent of the input signal direction.

$$V_{ISO} = \text{Off Channel Isolation} = 20 \text{ Log} \left( \frac{V_{OUT}}{V_{IN}} \right) \text{ or } V_{IN} \text{ at } 100 \text{ kHz}$$

$$V_{ONL} = \text{On Channel Loss} = 20 \text{ Log} \left( \frac{V_{OUT}}{V_{IN}} \right) \text{ for } V_{IN} \text{ at } 100 \text{ kHz to } 50 \text{ MHz}$$

Bandwidth (BW) = the frequency 3.0 dB below  $V_{ONL}$

$V_{CT}$  = Use  $V_{ISO}$  setup and test to all other switch analog input/outputs terminated with 50 Ω

**Figure 6. Off Channel Isolation/On Channel Loss (BW)/Crosstalk (On Channel to Off Channel)/ $V_{ONL}$**

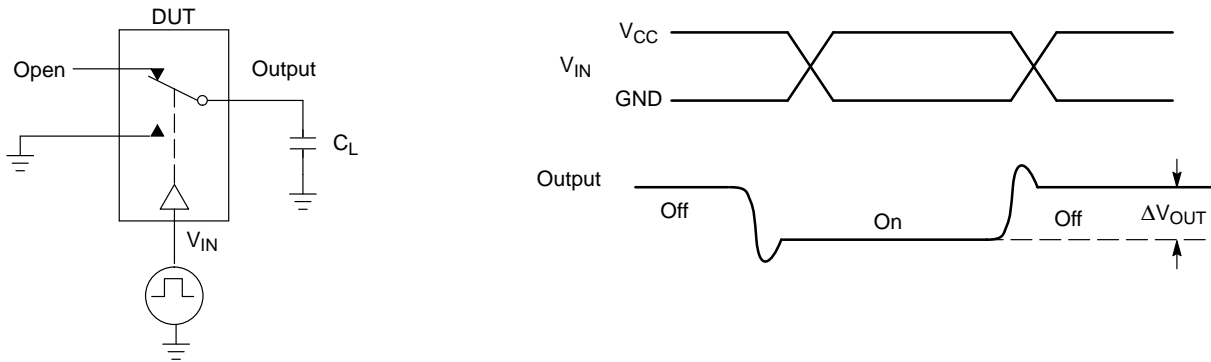

**Figure 7. Charge Injection: (Q)**

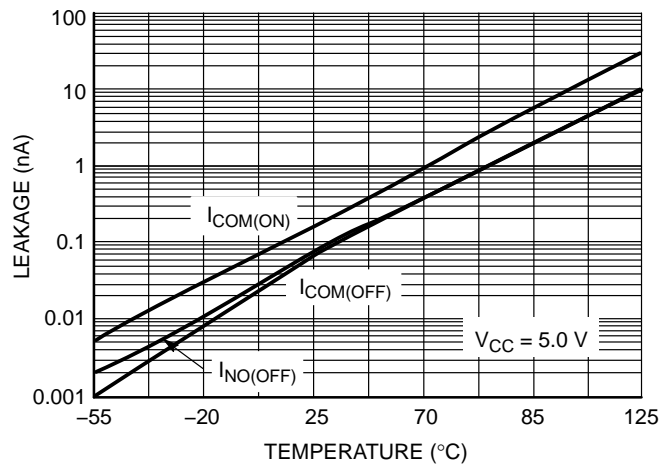

**Figure 8. Switch Leakage vs. Temperature**

# NLAS325

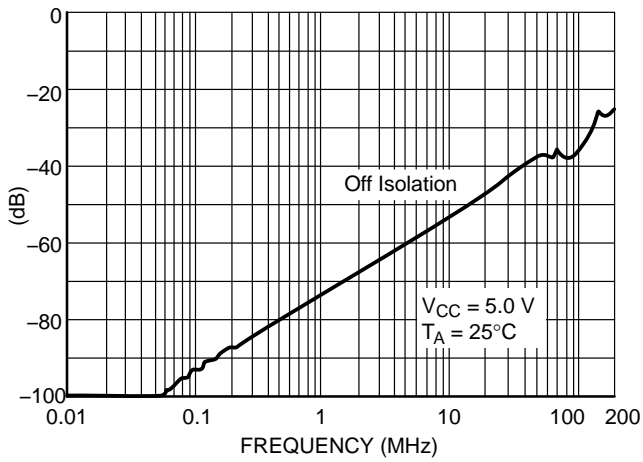

Figure 9. Off-Channel Isolation

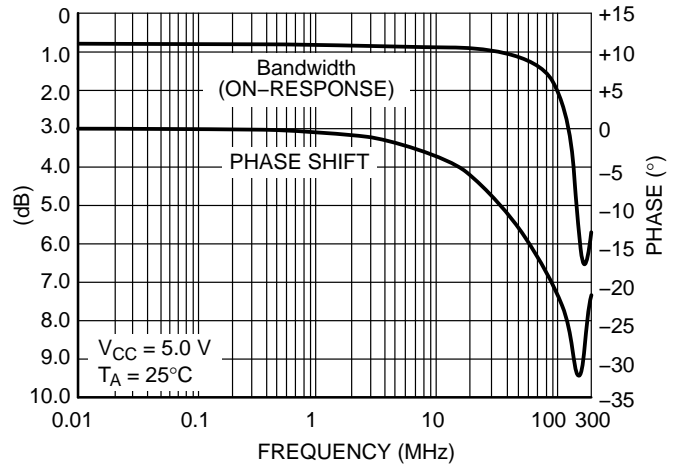

Figure 10. Typical Bandwidth and Phase Shift

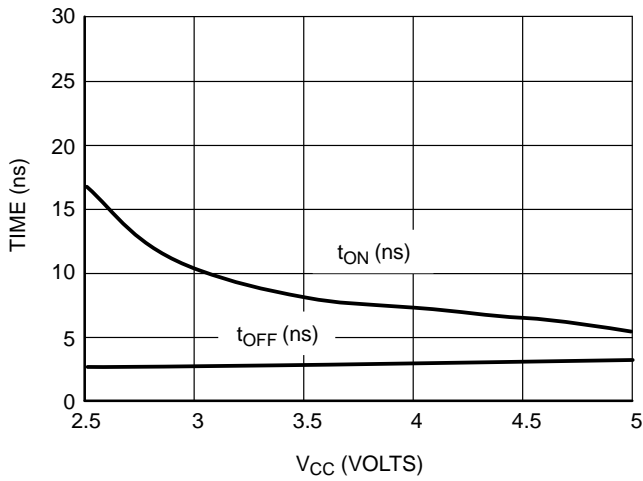

Figure 11.  $t_{ON}$  and  $t_{OFF}$  vs.  $V_{CC}$  at  $25^\circ\text{C}$

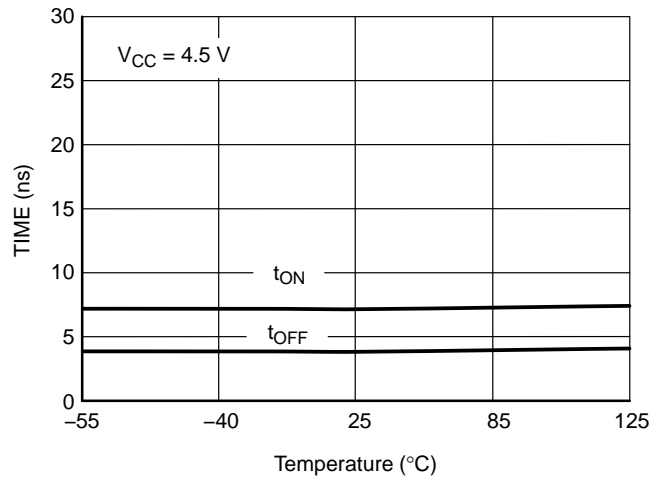

Figure 12.  $t_{ON}$  and  $t_{OFF}$  vs. Temp

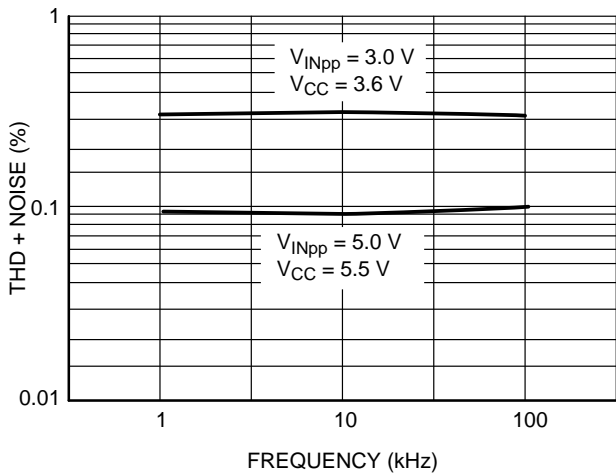

Figure 13. Total Harmonic Distortion Plus Noise vs. Frequency

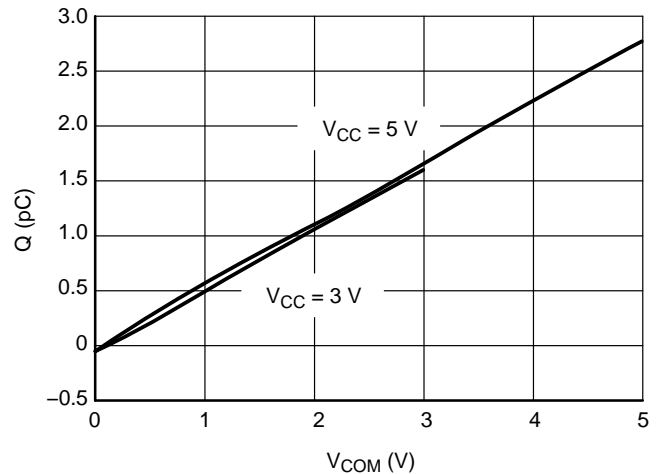

Figure 14. Charge Injection vs. COM Voltage

# NLAS325

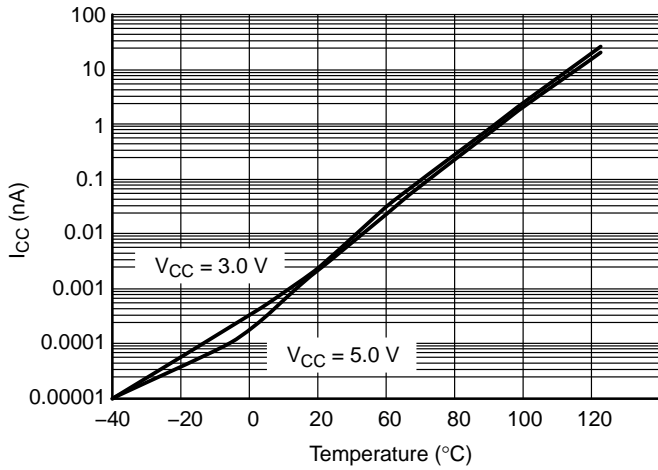

Figure 15.  $I_{CC}$  vs. Temp,  $V_{CC} = 3.0$  V and 5.0 V

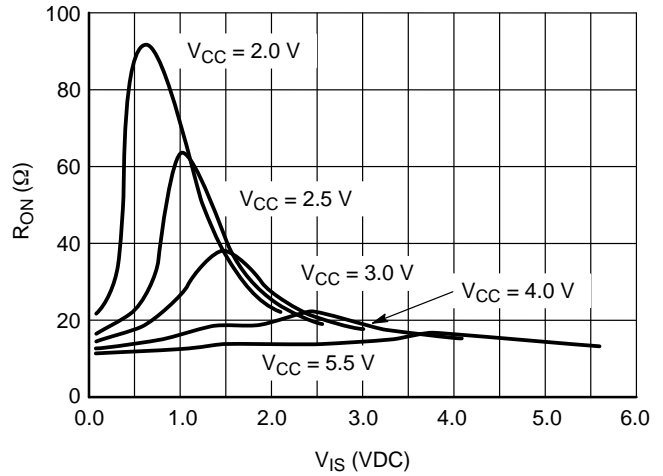

Figure 16.  $R_{ON}$  vs.  $V_{CC}$ , Temp = 25°C

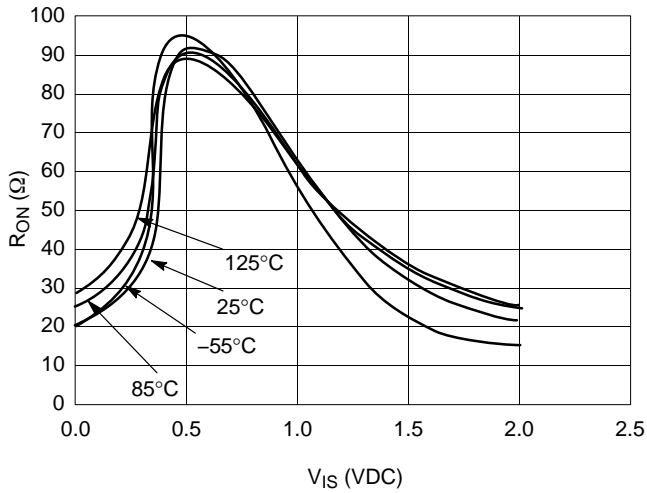

Figure 17.  $R_{ON}$  vs Temp,  $V_{CC} = 2.0$  V

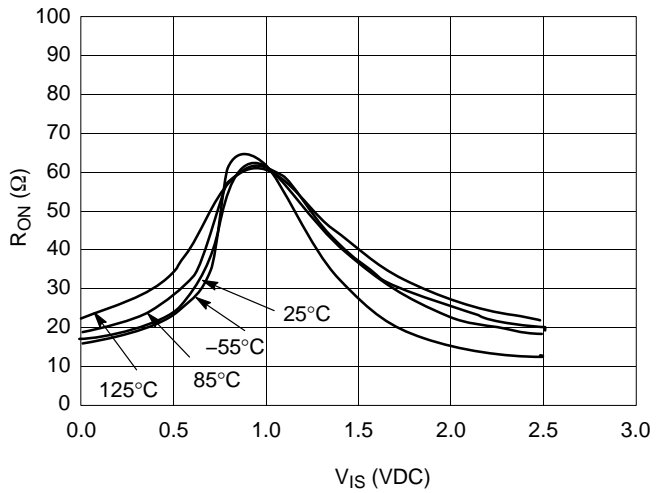

Figure 18.  $R_{ON}$  vs. Temp,  $V_{CC} = 2.5$  V

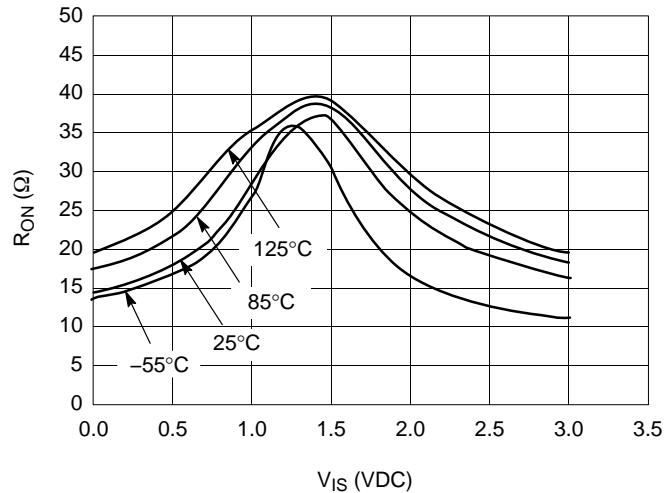

Figure 19.  $R_{ON}$  vs. Temp,  $V_{CC} = 3.0$  V

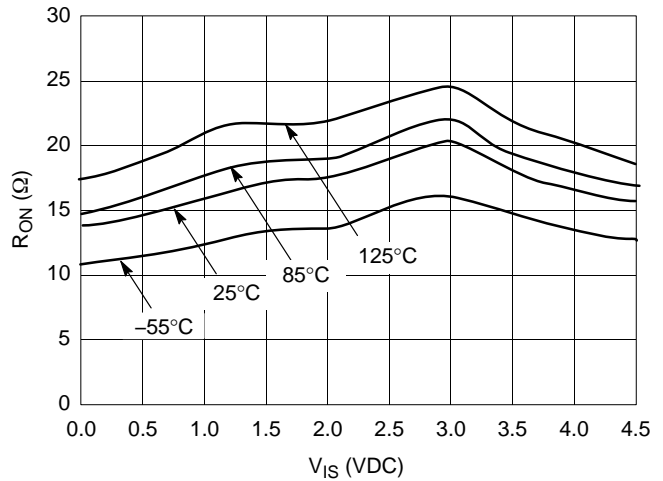

Figure 20.  $R_{ON}$  vs. Temp,  $V_{CC} = 4.5$  V



# NLAS325

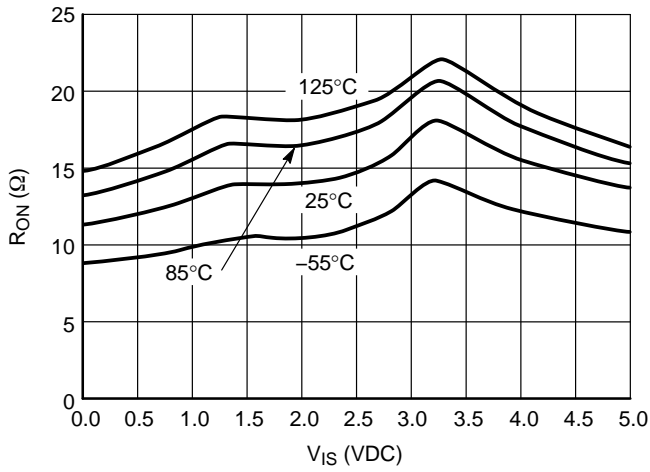

Figure 21. R<sub>ON</sub> vs. Temp, V<sub>CC</sub> = 5.0 V

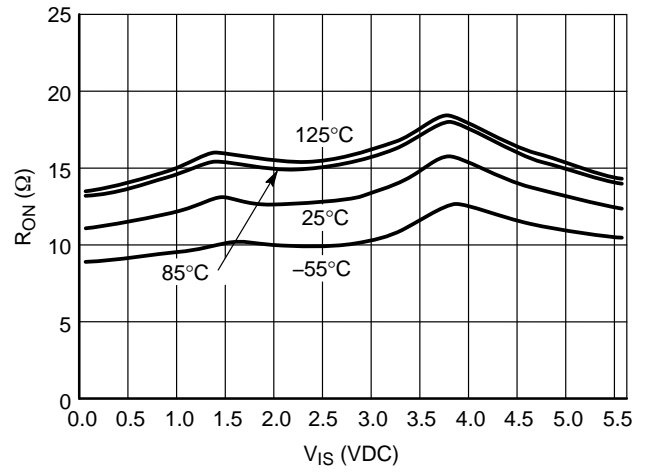

Figure 22. R<sub>ON</sub> vs. Temp, V<sub>CC</sub> = 5.5 V

## ORDERING INFORMATION

Device Order Number	Package Type	Tape and Reel Shippingize†
NLAS325USG	US8 (Pb-Free)	3000 / Tape & Reel

†For information on tape and reel specifications, including part orientation and tape sizes, please refer to our Tape and Reel Packaging Specification Brochure, BRD8011/D.

# MECHANICAL CASE OUTLINE PACKAGE DIMENSIONS



SCALE 4:1

**US8**  
CASE 493  
ISSUE F

DATE 01 SEP 2021



**NOTES:**

1. DIMENSIONING AND TOLERANCING PER ANSI Y14.5M, 1982.
2. CONTROLLING DIMENSION: MILLIMETERS
3. DIMENSION A DOES NOT INCLUDE MOLD FLASH, PROTRUSION, OR GATE BURR. MOLD FLASH, PROTRUSION, OR GATE BURR SHALL NOT EXCEED 0.14 (0.0055") PER SIDE.
4. DIMENSION B DOES NOT INCLUDE INTERLEAD FLASH OR PROTRUSION. INTERLEAD FLASH AND PROTRUSION SHALL NOT EXCEED 0.14 (0.0055") PER SIDE.
5. LEAD FINISH IS SOLDER PLATING WITH THICKNESS OF 0.0076-0.0203 MM (0.003-0.008").
6. ALL TOLERANCE UNLESS OTHERWISE SPECIFIED ±0.0508 MM (0.002").

DIM	MILLIMETERS		INCHES	
	MIN.	MAX.	MIN.	MAX.
A	1.90	2.10	0.075	0.083
B	2.20	2.40	0.087	0.094
C	0.60	0.90	0.024	0.035
D	0.17	0.25	0.007	0.010
F	0.20	0.35	0.008	0.014
G	0.50 BSC		0.020 BSC	
H	0.40 REF		0.016 REF	
J	0.10	0.18	0.004	0.007
K	0.00	0.10	0.000	0.004
L	3.00	3.25	0.118	0.128
M	0°	6°	0°	6°
N	0°	10°	0°	10°
P	0.23	0.34	0.010	0.013
R	0.23	0.33	0.009	0.013
S	0.37	0.47	0.015	0.019
U	0.60	0.80	0.024	0.031
V	0.12 BSC		0.005 BSC	

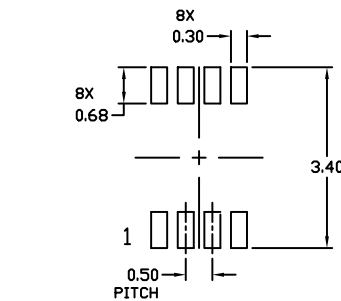

\* For additional information on our Pb-Free strategy and soldering details, please download the DN Semiconductor Soldering and Mounting Techniques Reference Manual, SOLDERM/D.

**GENERIC MARKING DIAGRAM\***

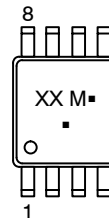

- XX = Specific Device Code
- M = Date Code
- = Pb-Free Package

(Note: Microdot may be in either location)

\*This information is generic. Please refer to device data sheet for actual part marking. Pb-Free indicator, "G" or microdot "▪", may or may not be present. Some products may not follow the Generic Marking.

<b>DOCUMENT NUMBER:</b>	<b>98AON04475D</b>	Electronic versions are uncontrolled except when accessed directly from the Document Repository. Printed versions are uncontrolled except when stamped "CONTROLLED COPY" in red.
<b>DESCRIPTION:</b>	<b>US8</b>	<b>PAGE 1 OF 1</b>

onsemi and ONSEMI are trademarks of Semiconductor Components Industries, LLC dba onsemi or its subsidiaries in the United States and/or other countries. onsemi reserves the right to make changes without further notice to any products herein. onsemi makes no warranty, representation or guarantee regarding the suitability of its products for any particular purpose, nor does onsemi assume any liability arising out of the application or use of any product or circuit, and specifically disclaims any and all liability, including without limitation special, consequential or incidental damages. onsemi does not convey any license under its patent rights nor the rights of others.

**onsemi**, **Onsemi**, and other names, marks, and brands are registered and/or common law trademarks of Semiconductor Components Industries, LLC dba "**onsemi**" or its affiliates and/or subsidiaries in the United States and/or other countries. **onsemi** owns the rights to a number of patents, trademarks, copyrights, trade secrets, and other intellectual property. A listing of **onsemi**'s product/patent coverage may be accessed at [www.onsemi.com/site/pdf/Patent-Marking.pdf](http://www.onsemi.com/site/pdf/Patent-Marking.pdf). **onsemi** reserves the right to make changes at any time to any products or information herein, without notice. The information herein is provided "as-is" and **onsemi** makes no warranty, representation or guarantee regarding the accuracy of the information, product features, availability, functionality, or suitability of its products for any particular purpose, nor does **onsemi** assume any liability arising out of the application or use of any product or circuit, and specifically disclaims any and all liability, including without limitation special, consequential or incidental damages. Buyer is responsible for its products and applications using **onsemi** products, including compliance with all laws, regulations and safety requirements or standards, regardless of any support or applications information provided by **onsemi**. "Typical" parameters which may be provided in **onsemi** data sheets and/or specifications can and do vary in different applications and actual performance may vary over time. All operating parameters, including "Typicals" must be validated for each customer application by customer's technical experts. **onsemi** does not convey any license under any of its intellectual property rights nor the rights of others. **onsemi** products are not designed, intended, or authorized for use as a critical component in life support systems or any FDA Class 3 medical devices or medical devices with a same or similar classification in a foreign jurisdiction or any devices intended for implantation in the human body. Should Buyer purchase or use **onsemi** products for any such unintended or unauthorized application, Buyer shall indemnify and hold **onsemi** and its officers, employees, subsidiaries, affiliates, and distributors harmless against all claims, costs, damages, and expenses, and reasonable attorney fees arising out of, directly or indirectly, any claim of personal injury or death associated with such unintended or unauthorized use, even if such claim alleges that **onsemi** was negligent regarding the design or manufacture of the part. **onsemi** is an Equal Opportunity/Affirmative Action Employer. This literature is subject to all applicable copyright laws and is not for resale in any manner.

## PUBLICATION ORDERING INFORMATION

### LITERATURE FULFILLMENT:

Email Requests to: [orderlit@onsemi.com](mailto:orderlit@onsemi.com)

**onsemi Website:** [www.onsemi.com](http://www.onsemi.com)

### TECHNICAL SUPPORT

**North American Technical Support:**

Voice Mail: 1 800-282-9855 Toll Free USA/Canada

Phone: 011 421 33 790 2910

**Europe, Middle East and Africa Technical Support:**

Phone: 00421 33 790 2910

For additional information, please contact your local Sales Representative