

Q1PACK Module

NXH75M65L4Q1SG, NXH75M65L4Q1PTG

This high-density, integrated power module combines high-performance IGBTs with rugged anti-parallel diodes.

Features

- Extremely Efficient Trench with Fieldstop Technology
- Low Switching Loss Reduces System Power Dissipation
- Module Design Offers High Power Density
- Low Inductive Layout
- Q1PACK Packages with Solder and Pressfit Pins

Typical Applications

- Solar Inverters
- Uninterruptable Power Supplies

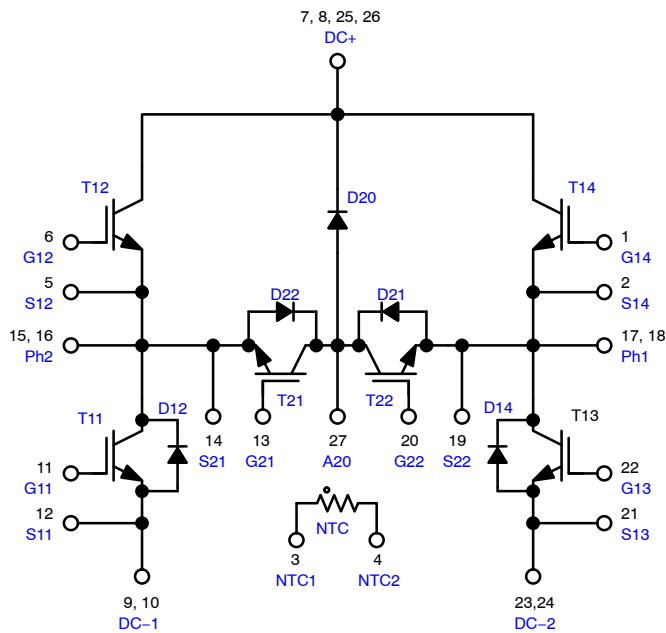

Figure 1. Schematic

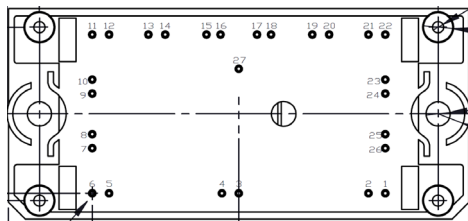
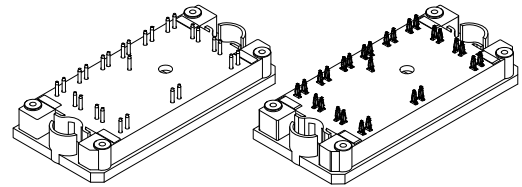

Figure 2. Pin Assignments

75 A, 650 V Module



PIM27, 71x37.4
(SOLDER PIN)
CASE 180CA

PIM27, 71x37.4
(PRESSFIT PIN)
CASE 180CP

MARKING DIAGRAM

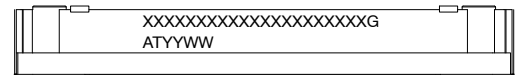

XXXXXX = Specific Device Code
G = Pb-Free Package
AT = Assembly & Test Site Code
YYWW = Year and Work Week Code

ORDERING INFORMATION

See detailed ordering and shipping information on page 9 of this data sheet.

NXH75M65L4Q1SG, NXH75M65L4Q1PTG

ABSOLUTE MAXIMUM RATINGS

Rating	Symbol	Value	Unit
IGBT (T11, T12, T13, T14, T21, T22)			
Collector-emitter voltage	V_{CES}	650	V
Collector current @ $T_h = 80^\circ\text{C}$ (per IGBT)	I_C	59	A
Pulsed collector current, T_{pulse} limited by $T_{j\text{max}}$	I_{CM}	176	A
Power Dissipation Per IGBT $T_j = T_{j\text{max}}, T_h = 80^\circ\text{C}$	P_{tot}	83	W
Gate-emitter voltage	V_{GE}	± 20	V
Maximum Junction Temperature	T_J	175	$^\circ\text{C}$

DIODE (D12, D14, D20, D21, D22)

Peak Repetitive Reverse Voltage	V_{RRM}	650	V
Forward Current, DC @ $T_h = 80^\circ\text{C}$ (per Diode)	I_F	50	A
Nonrepetitive Peak Surge Current (Surge applied at rated load conditions halfwave, single phase, 60 Hz)	I_{FSM}	225	A
Power Dissipation Per Diode $T_j = T_{j\text{max}}, T_h = 80^\circ\text{C}$	P_{tot}	86	W
Maximum Junction Temperature	T_J	175	$^\circ\text{C}$

THERMAL PROPERTIES

Operating Temperature under switching condition	$T_{VJ\text{OP}}$	-40 to ($T_{j\text{max}} - 25$)	$^\circ\text{C}$
Storage Temperature range	T_{stg}	-40 to 125	$^\circ\text{C}$

INSULATION PROPERTIES

Isolation test voltage, $t = 2$ min, 60 Hz	V_{is}	4000	Vac
Creepage distance		12.7	mm

Stresses exceeding those listed in the Maximum Ratings table may damage the device. If any of these limits are exceeded, device functionality should not be assumed, damage may occur and reliability may be affected.

ELECTRICAL CHARACTERISTICS ($T_J = 25^\circ\text{C}$ unless otherwise specified)

Parameter	Test Condition	Symbol	Min	Typ	Max	Unit
IGBT (T11, T12, T13, T14, T21, T22)						
Collector-emitter cutoff current	$V_{GE} = 0\text{ V}, V_{CE} = 650\text{ V}$	I_{CES}	-	-	300	μA
Collector-emitter saturation voltage	$V_{GE} = 15\text{ V}, I_C = 75\text{ A}, T_j = 25^\circ\text{C}$ $V_{GE} = 15\text{ V}, I_C = 75\text{ A}, T_j = 150^\circ\text{C}$	$V_{CE(\text{sat})}$	-	1.56 1.76	2.22 -	V
Gate-emitter threshold voltage	$V_{GE} = V_{CE}, I_C = 75\text{ mA}$	$V_{GE(\text{TH})}$	3.1	4.45	5.2	V
Gate leakage current	$V_{GE} = 20\text{ V}, V_{CE} = 0\text{ V}$	I_{GES}	-	-	400	nA
Turn-on delay time	$T_j = 25^\circ\text{C}$ $V_{CE} = 350\text{ V}, I_C = 80\text{ A}$ $V_{GE} = 15\text{ V}, -9\text{ V}, R_G = 10\ \Omega$	$t_{d(\text{on})}$	-	38	-	ns
Rise time		t_r	-	34	-	
Turn-off delay time		$t_{d(\text{off})}$	-	129	-	
Fall time		t_f	-	17	-	
Turn on switching loss		E_{on}	-	0.606	-	mJ
Turn off switching loss		E_{off}	-	0.903	-	
Turn-on delay time	$T_j = 125^\circ\text{C}$ $V_{CE} = 350\text{ V}, I_C = 80\text{ A}$ $V_{GE} = 15\text{ V}, -9\text{ V}, R_G = 10\ \Omega$	$t_{d(\text{on})}$	-	37	-	ns
Rise time		t_r	-	34	-	
Turn-off delay time		$t_{d(\text{off})}$	-	139	-	
Fall time		t_f	-	23	-	
Turn on switching loss		E_{on}	-	1.024	-	mJ
Turn off switching loss		E_{off}	-	1.141	-	

NXH75M65L4Q1SG, NXH75M65L4Q1PTG

ELECTRICAL CHARACTERISTICS ($T_J = 25^\circ\text{C}$ unless otherwise specified) (continued)

Parameter	Test Condition	Symbol	Min	Typ	Max	Unit
IGBT (T11, T12, T13, T14, T21, T22)						
Input capacitance	$V_{CE} = 30\text{ V}, V_{GE} = 0\text{ V}, f = 1\text{ MHz}$	C_{ies}	–	5665	–	pF
Output capacitance		C_{oes}	–	205	–	
Reverse transfer capacitance		C_{res}	–	100	–	
Gate charge total	$V_{CE} = 480\text{ V}, I_C = 50\text{ A}, V_{GE} = \pm 15\text{ V}$	Q_g	–	550	–	nC
Thermal Resistance – chip–to–heatsink	Thermal grease, Thickness = 2.1 Mil $\pm 2\%$ $\lambda = 2.9\text{ W/mK}$	R_{thJH}	–	1.15	–	$^\circ\text{C/W}$
Thermal Resistance – chip–to–case		R_{thJC}	–	0.75	–	$^\circ\text{C/W}$

IGBT INVERSE DIODE (D12, D14, D21, D22)

Forward voltage	$I_F = 50\text{ A}, T_J = 25^\circ\text{C}$ $I_F = 50\text{ A}, T_J = 175^\circ\text{C}$	V_F	– –	2.25 1.7	2.7 –	V
Reverse Recovery Time	$T_J = 25^\circ\text{C}$ $V_{CE} = 350\text{ V}, I_C = 80\text{ A}$ $V_{GE} = 15\text{ V}, -9\text{ V}, R_G = 10\ \Omega$	t_{rr}	–	63	–	ns
Reverse Recovery Current		Q_{rr}	–	552	–	nC
Peak Reverse Recovery Current		I_{rrm}	–	25	–	A
Peak Rate of Fall of Recovery Current		Di/dt_{max}	–	1.80	–	A/ μs
Reverse Recovery Energy		E_{rr}	–	136	–	μJ
Reverse Recovery Time	$T_J = 125^\circ\text{C}$ $V_{CE} = 350\text{ V}, I_C = 50\text{ A}$ $V_{GE} = 15\text{ V}, -9\text{ V}, R_G = 10\ \Omega$	t_{rr}	–	135	–	ns
Reverse Recovery Current		Q_{rr}	–	1538	–	nC
Peak Reverse Recovery Current		I_{rrm}	–	43	–	A
Peak Rate of Fall of Recovery Current		Di/dt_{max}	–	1.60	–	A/ μs
Reverse Recovery Energy		E_{rr}	–	346	–	μJ
Thermal Resistance – chip–to–heatsink	Thermal grease, Thickness = 2.1 Mil $\pm 2\%$ $\lambda = 2.9\text{ W/mK}$	R_{thJH}	–	1.10	–	$^\circ\text{C/W}$
Thermal Resistance – chip–to–case		R_{thJC}	–	0.79	–	$^\circ\text{C/W}$

DIODE (D20)

Forward voltage	$I_F = 50\text{ A}, T_J = 25^\circ\text{C}$ $I_F = 50\text{ A}, T_J = 175^\circ\text{C}$	V_F	– –	2.25 1.7	2.7 –	V
Reverse leakage current	$V_{CE} = 650\text{ V}, V_{GE} = 0\text{ V}$	I_r	–	–	300	μA
Thermal Resistance – chip–to–heatsink	Thermal grease, Thickness = 2.1 Mil $\pm 2\%$ $\lambda = 2.9\text{ W/mK}$	R_{thJH}	–	1.10	–	$^\circ\text{C/W}$
Thermal Resistance – chip–to–case		R_{thJC}	–	0.79	–	$^\circ\text{C/W}$

THERMISTOR CHARACTERISTICS

Nominal resistance	$T = 25^\circ\text{C}$	R_{25}	–	22	–	k Ω
Nominal resistance	$T = 100^\circ\text{C}$	R_{100}	–	1486	–	Ω
Deviation of R_{25}		R/R	–5	–	5	%
Power dissipation		P_D	–	200	–	mW
Power dissipation constant			–	2	–	mW/ $^\circ\text{C}$
B-value	B (25/50), tol $\pm 3\%$		–	–	3950	$^\circ\text{C}$
B-value	B (25/100), tol $\pm 3\%$		–	–	3998	$^\circ\text{C}$
NTC reference			–	–	B	

Product parametric performance is indicated in the Electrical Characteristics for the listed test conditions, unless otherwise noted. Product performance may not be indicated by the Electrical Characteristics if operated under different conditions.

NXH75M65L4Q1SG, NXH75M65L4Q1PTG

TYPICAL CHARACTERISTICS – IGBT (T11, T12, T13, T14, T21, T22)

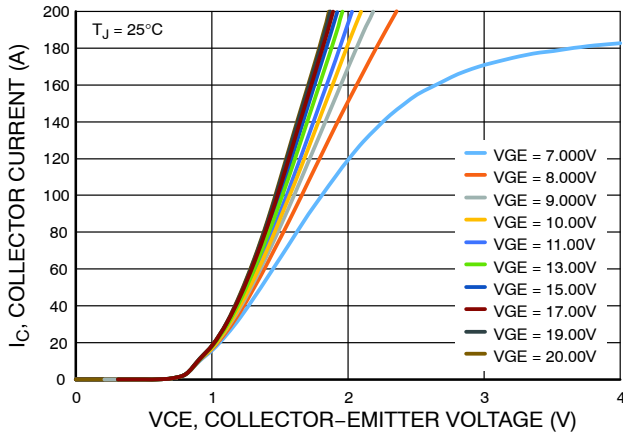

Figure 3. Typical Output Characteristics

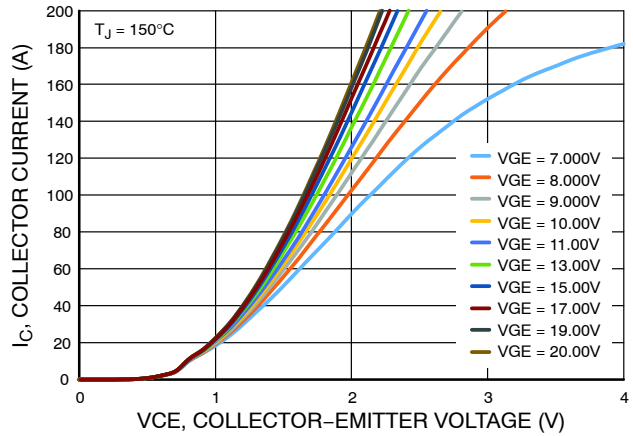

Figure 4. Typical Output Characteristics

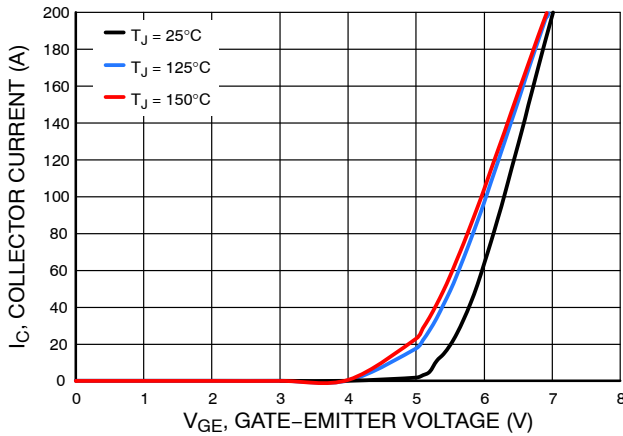

Figure 5. Typical Transfer Characteristics

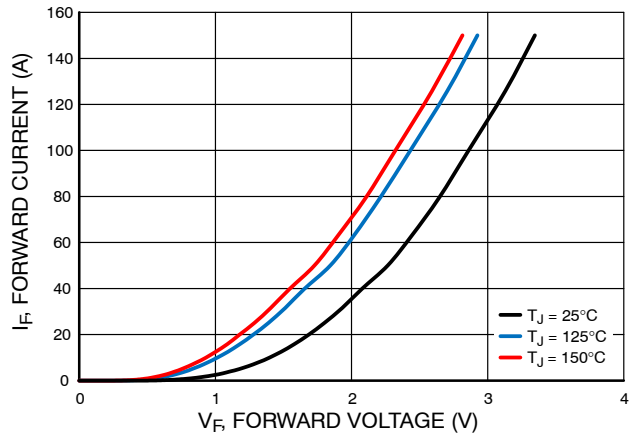

Figure 6. Diode Forward Characteristics

TYPICAL CHARACTERISTICS – (T11, T12, T13, T14) IGBT COMMUTATES D21, D22 DIODE

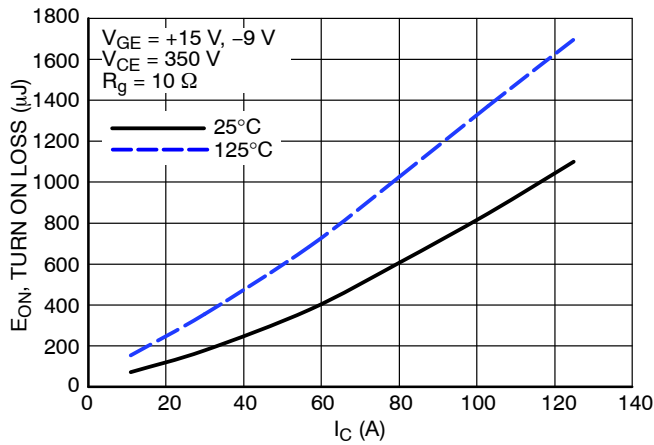

Figure 7. Typical Turn ON Loss vs. IC

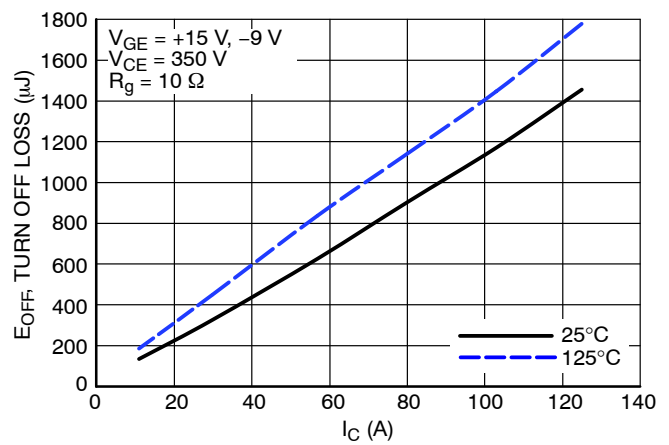

Figure 8. Typical Turn OFF Loss vs. IC

NXH75M65L4Q1SG, NXH75M65L4Q1PTG

TYPICAL CHARACTERISTICS – (T11, T12, T13, T14) IGBT COMMUTATES D21, D22 DIODE (CONTINUED)

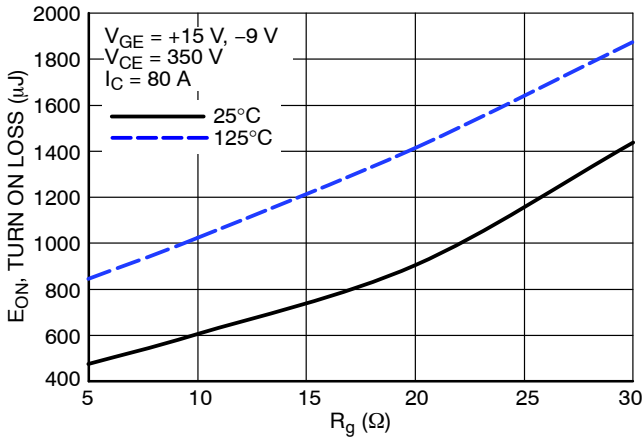

Figure 9. Typical Turn ON Loss vs. Rg

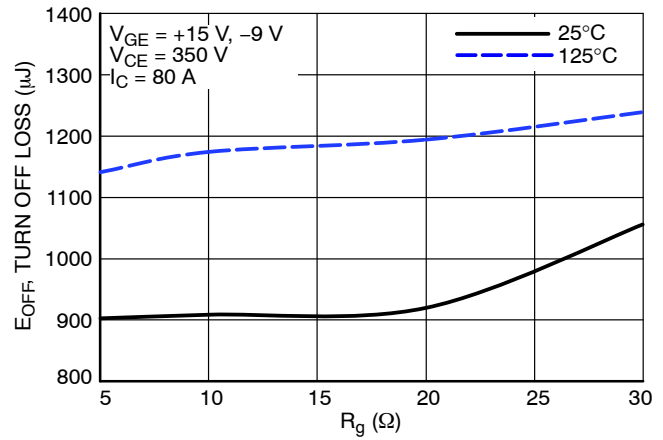

Figure 10. Typical Turn OFF Loss vs. Rg

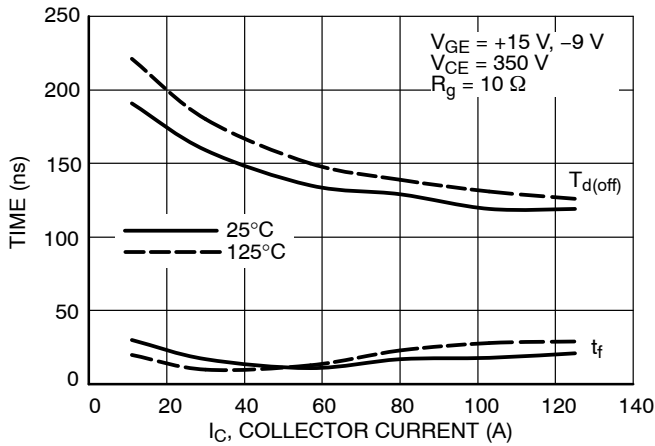

Figure 11. Typical Turn-Off Switching Time vs. IC

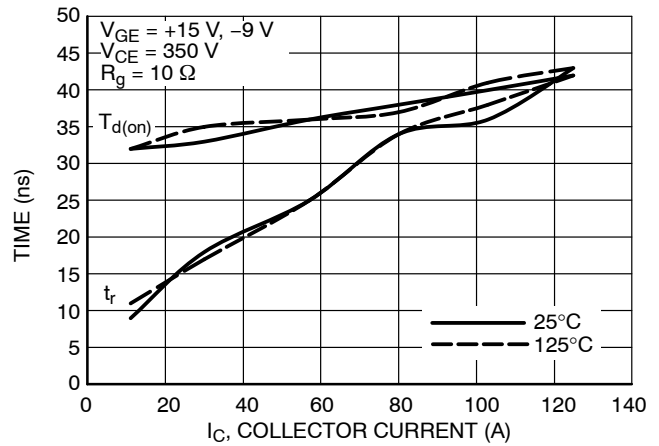

Figure 12. Typical Turn-On Switching Time vs. IC

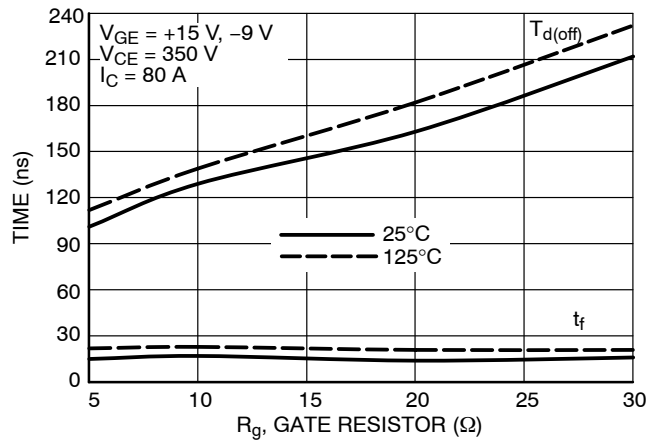

Figure 13. Typical Turn-Off Switching Time vs. Rg

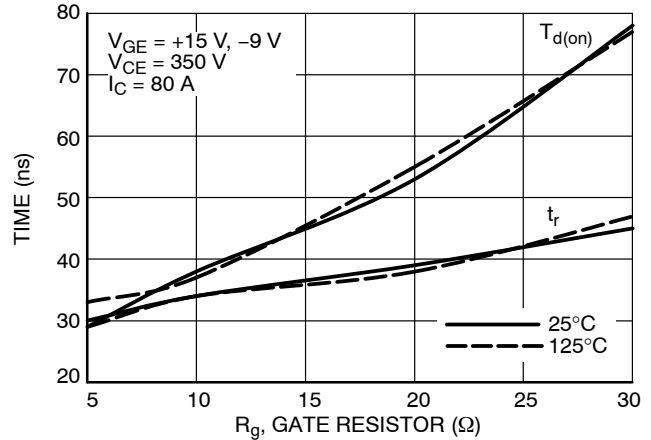

Figure 14. Typical Turn-On Switching Time vs. Rg

NXH75M65L4Q1SG, NXH75M65L4Q1PTG

TYPICAL CHARACTERISTICS - (T21, T22) IGBT COMMUTATES D20 DIODE

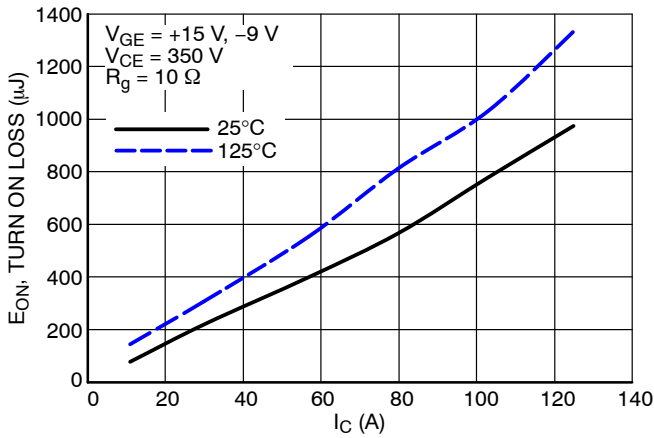

Figure 15. Typical Turn ON Loss vs. IC

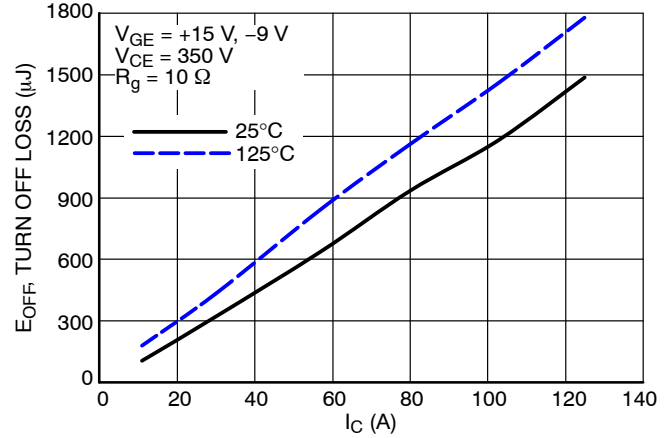

Figure 16. Typical Turn OFF Loss vs. IC

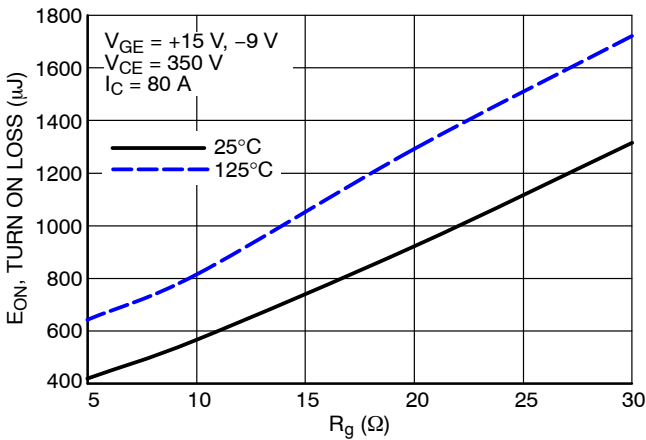

Figure 17. Typical Turn ON Loss vs. R_G

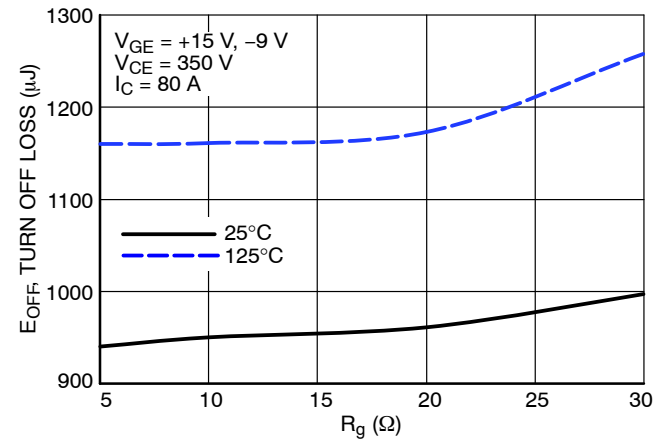

Figure 18. Typical Turn OFF Loss vs. R_G

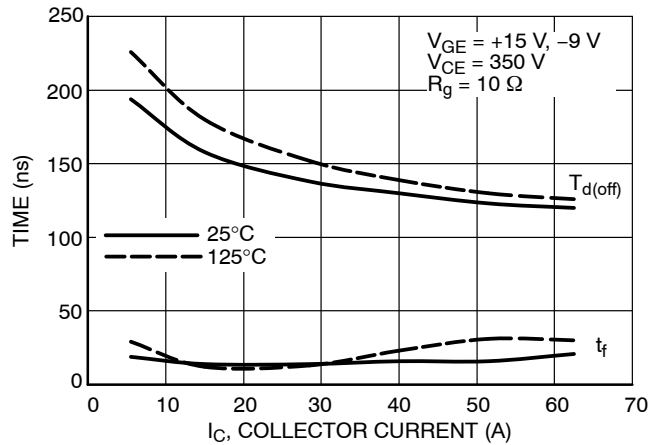

Figure 19. Typical Turn-Off Switching Time vs. IC

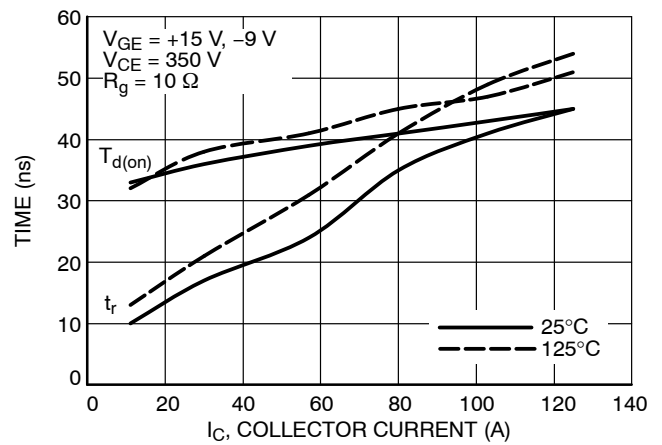

Figure 20. Typical Turn-On Switching Time vs. IC

NXH75M65L4Q1SG, NXH75M65L4Q1PTG

TYPICAL CHARACTERISTICS – (T21, T22) IGBT COMMUTATES D20 DIODE (CONTINUED)

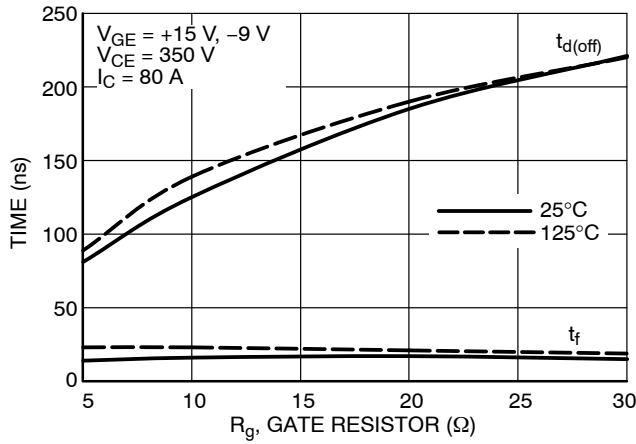

Figure 21. Typical Turn-Off Switching Time vs. Rg

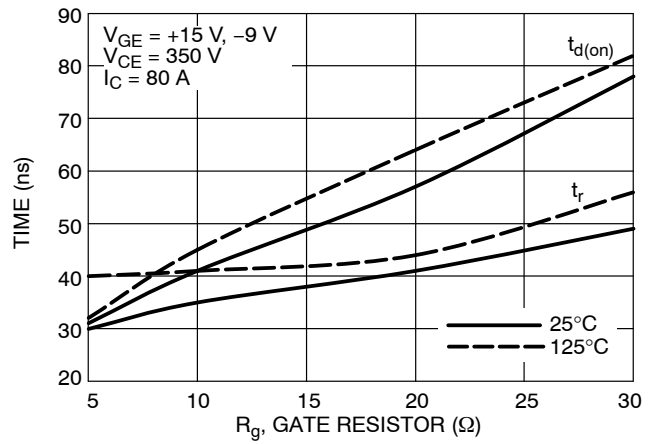

Figure 22. Typical Turn-On Switching Time vs. Rg

TYPICAL CHARACTERISTICS – DIODE

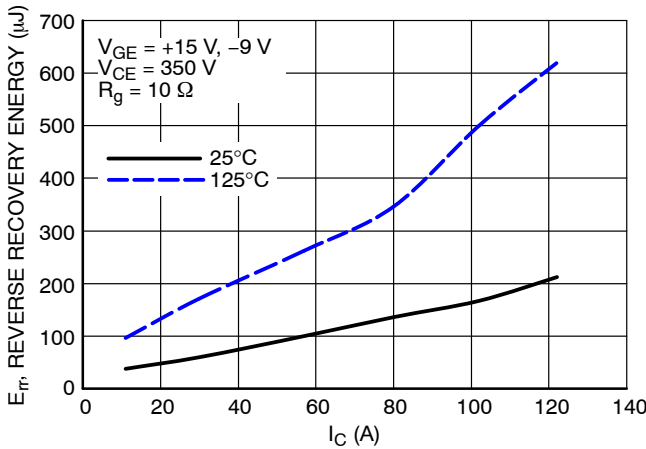

Figure 23. Typical Reverse Recovery Energy Loss vs. IC

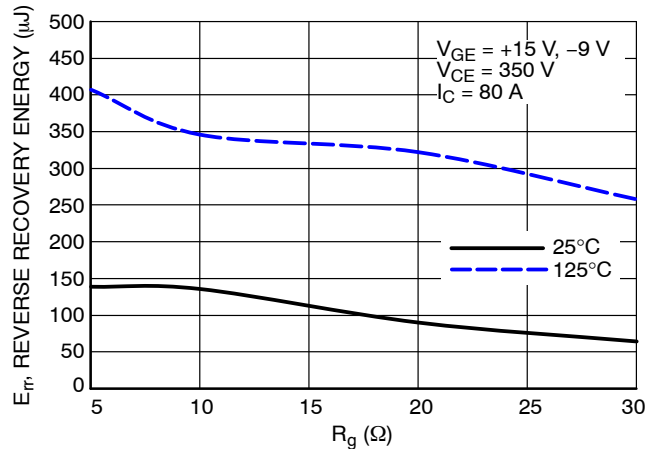

Figure 24. Typical Reverse Recovery Energy Loss vs. Rg

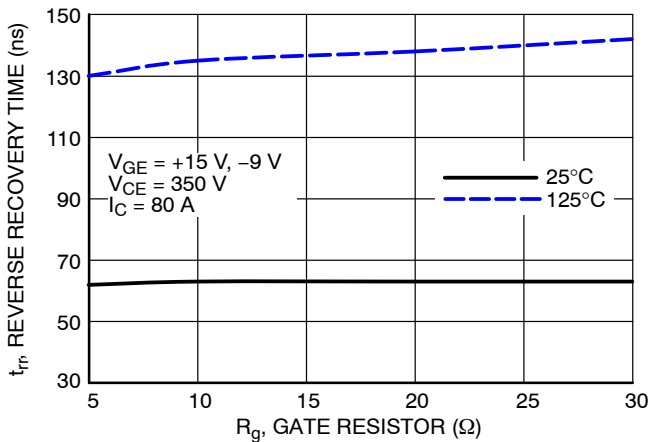

Figure 25. Typical Reverse Recovery Time vs. Rg

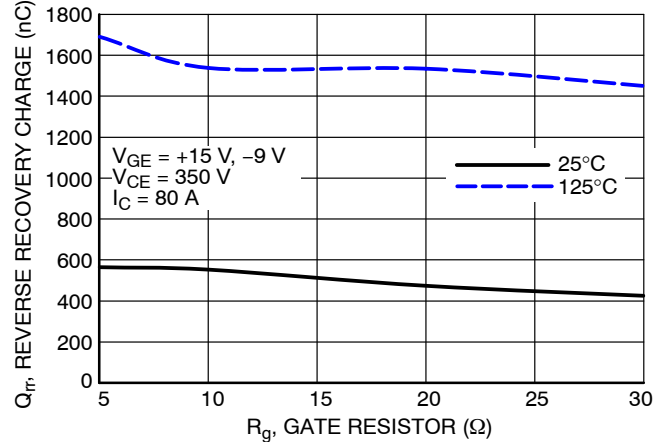

Figure 26. Typical Reverse Recovery Charge vs. Rg

NXH75M65L4Q1SG, NXH75M65L4Q1PTG

TYPICAL CHARACTERISTICS – DIODE (CONTINUED)

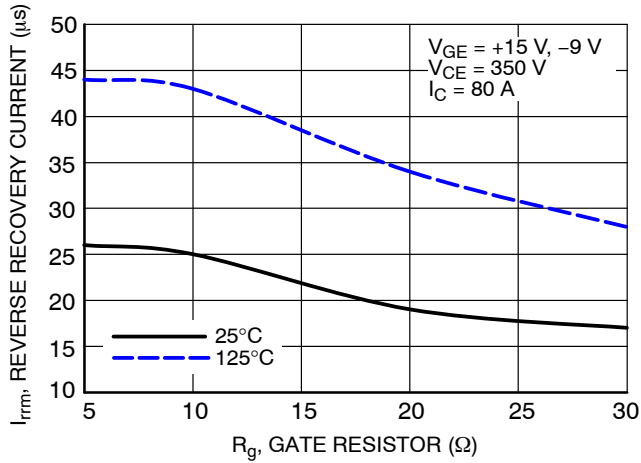

Figure 27. Typical Reverse Recovery Peak Current vs. Rg

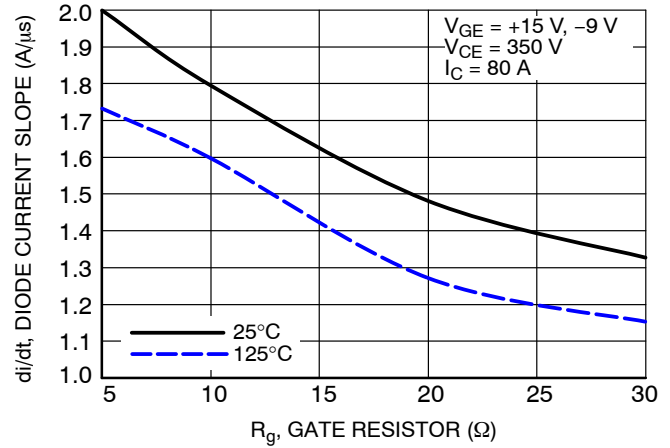

Figure 28. Typical di/dt vs. Rg

TYPICAL CHARACTERISTICS

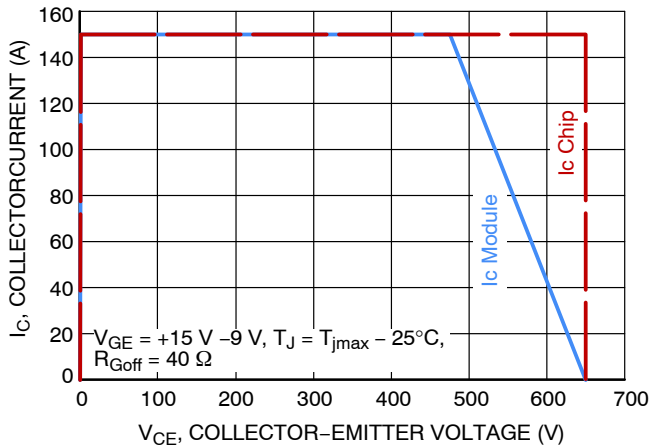

Figure 29. RBSOA Reverse Safe Operating Area

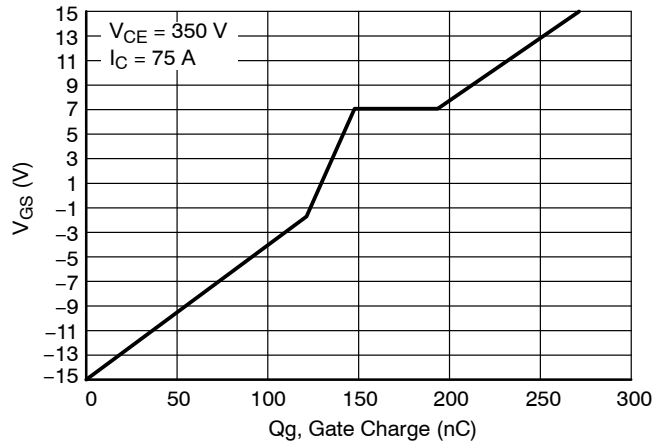

Figure 30. IGBT Gate Charge

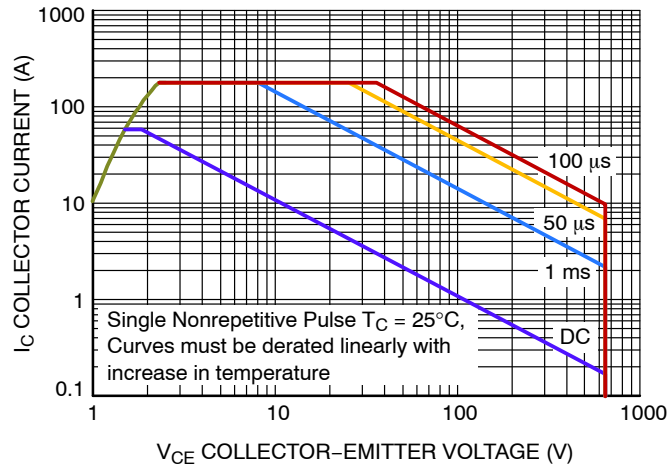

Figure 31. IGBT Safe Operating Area

NXH75M65L4Q1SG, NXH75M65L4Q1PTG

TYPICAL THERMAL CHARACTERISTICS

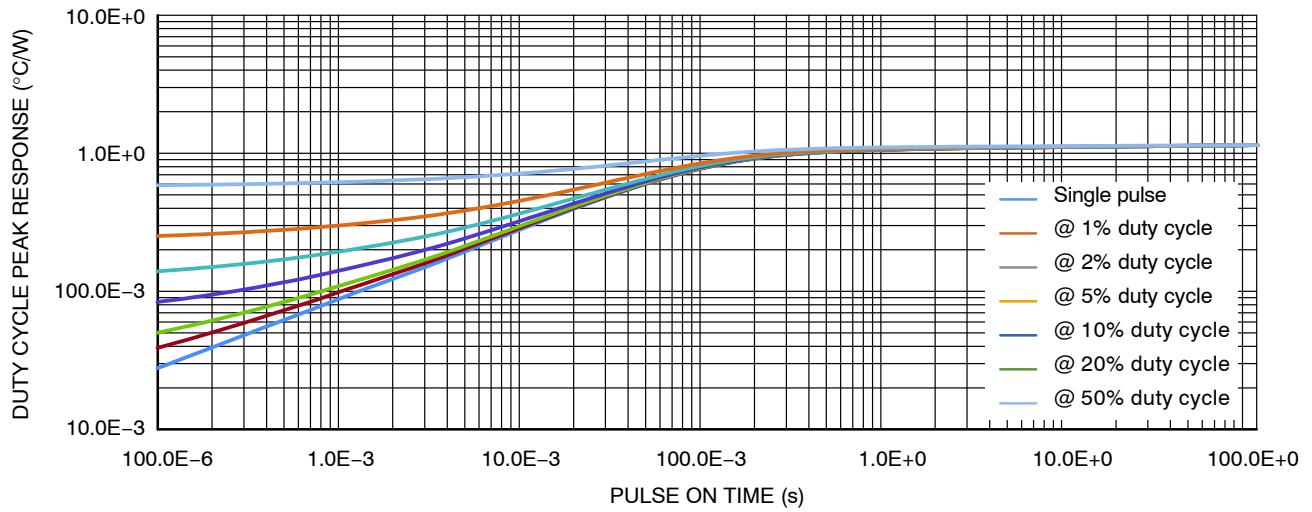

Figure 32. Transient Thermal Impedance – IGBT

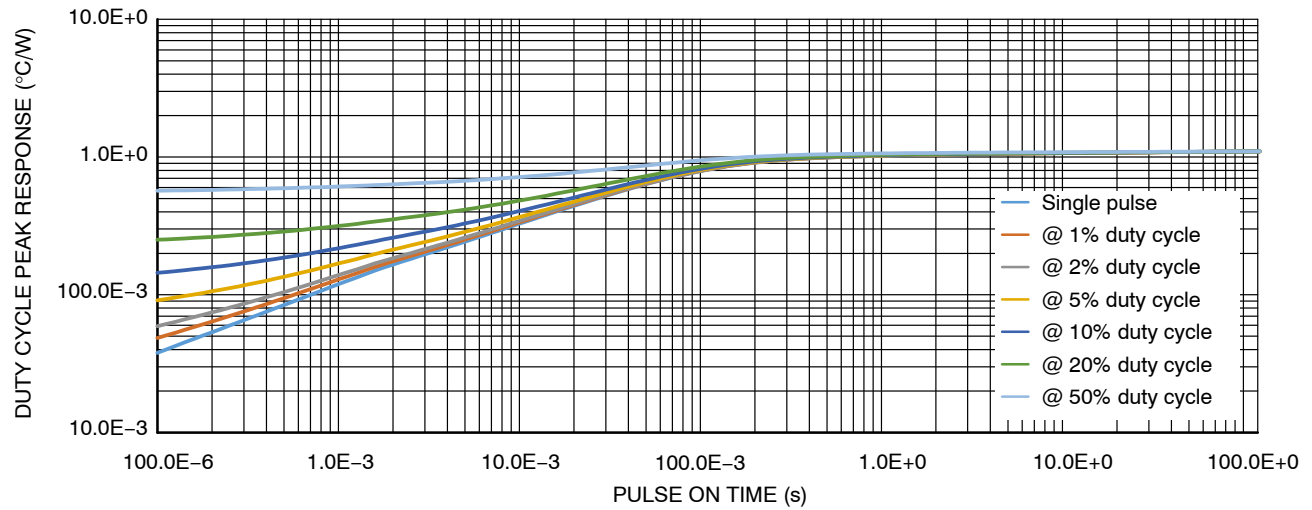

Figure 33. Transient Thermal Impedance – Diode

ORDERING INFORMATION

Device	Package Type	Shipping
NXH75M65L4Q1SG (Solder Pin)	PIM27, 71x37.4 Q1PACK	21 Units / BTRAY
NXH75M65L4Q1PTG (Pressfit Pin)	PIM27, 71x37.4 Q1PACK	21 Units / BTRAY

MECHANICAL CASE OUTLINE

PACKAGE DIMENSIONS



PIM27, 71x37.4 (SOLDER PIN)
CASE 180CA
ISSUE B

DATE 14 DEC 2022

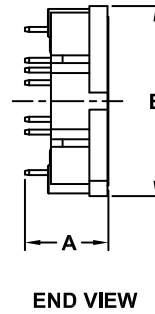
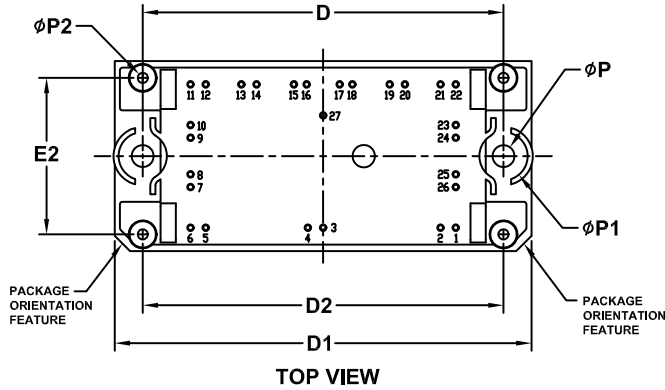
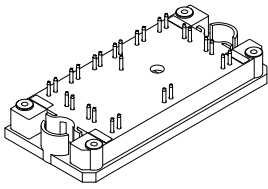

DIM	MILLIMETERS		
	MIN.	NOM.	MAX.
A	15.90	16.40	16.90
A2	11.70	11.90	12.10
A3	0.00	0.20	0.60
b	0.95	1.00	1.05
b1	0.75	0.80	0.85
D	70.80	71.00	71.20
D1	81.70	82.00	82.30
D2	70.80	71.00	71.20
E	37.10	37.40	37.70
E2	30.60	30.80	31.00
P	4.10	4.30	4.50
P1	9.30	9.50	9.70
P2	1.80	2.00	2.20

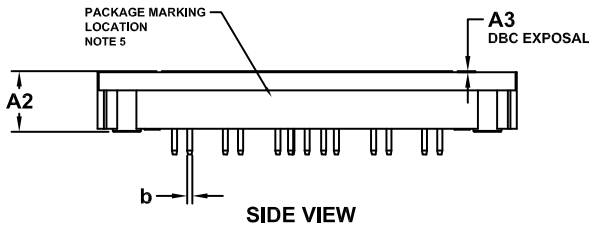

NOTE 4

PIN	PIN POSITION		PIN	PIN POSITION	
	X	Y		X	Y
1	52.20	0.00	15	20.35	28.20
2	49.20	0.00	16	22.85	28.20
3	26.10	0.00	17	29.35	28.20
4	23.10	0.00	18	31.85	28.20
5	3.00	0.00	19	39.20	28.20
6	0.00	0.00	20	42.20	28.20
7	0.00	8.00	21	49.20	28.20
8	0.00	10.50	22	52.20	28.20
9	0.00	17.70	23	52.20	20.20
10	0.00	20.20	24	52.20	17.70
11	0.00	28.20	25	52.20	10.50
12	3.00	28.20	26	52.20	8.00
13	10.00	28.20	27	26.10	22.10
14	13.00	28.20			

NOTES:

1. DIMENSIONING AND TOLERANCING PER ASME Y14.5M, 2009
2. CONTROLLING DIMENSION : MILLIMETERS
3. DIMENSIONS b AND b1 APPLY TO THE PLATED TERMINALS AND ARE MEASURED AT DIMENSION A1
4. PIN POSITION TOLERANCE IS $\pm 0.4\text{mm}$
5. PACKAGE MARKING IS LOCATED AS SHOWN ON THE SIDE OPPOSITE THE PACKAGE ORIENTATION FEATURES

DOCUMENT NUMBER:	98AON20006H	Electronic versions are uncontrolled except when accessed directly from the Document Repository. Printed versions are uncontrolled except when stamped "CONTROLLED COPY" in red.
DESCRIPTION:	PIM27, 71X37.4 (SOLDER PIN)	PAGE 1 OF 2

onsemi and ONSEMI are trademarks of Semiconductor Components Industries, LLC dba onsemi or its subsidiaries in the United States and/or other countries. onsemi reserves the right to make changes without further notice to any products herein. onsemi makes no warranty, representation or guarantee regarding the suitability of its products for any particular purpose, nor does onsemi assume any liability arising out of the application or use of any product or circuit, and specifically disclaims any and all liability, including without limitation special, consequential or incidental damages. onsemi does not convey any license under its patent rights nor the rights of others.

**MECHANICAL CASE OUTLINE
PACKAGE DIMENSIONS**



**PIM27, 71x37.4 (SOLDER PIN)
CASE 180CA
ISSUE B**

DATE 14 DEC 2022

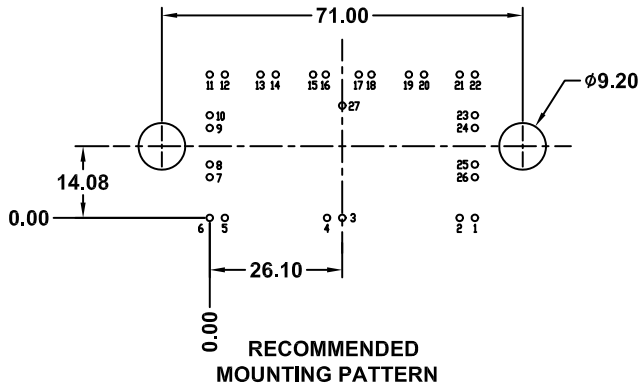

* For additional information on our Pb-Free strategy and soldering details, please download the ON Semiconductor Soldering and Mounting Techniques Reference Manual, SOLDERRM/D.

GENERIC MARKING DIAGRAM*

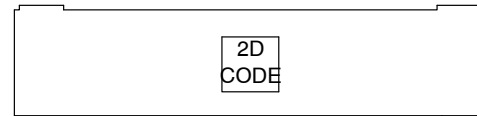
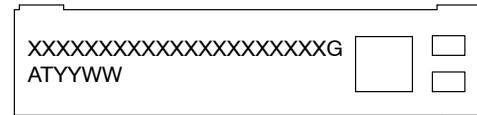

XXXXX = Specific Device Code
G = Pb-Free Device
AT = Assembly & Test Site Code
YYWW = Year and Work Week Code

*This information is generic. Please refer to device data sheet for actual part marking. Pb-Free indicator, "G" or microdot "•", may or may not be present. Some products may not follow the Generic Marking.

DOCUMENT NUMBER:	98AON20006H	Electronic versions are uncontrolled except when accessed directly from the Document Repository. Printed versions are uncontrolled except when stamped "CONTROLLED COPY" in red.
DESCRIPTION:	PIM27, 71X37.4 (SOLDER PIN)	PAGE 2 OF 2

onsemi and onsemi are trademarks of Semiconductor Components Industries, LLC dba onsemi or its subsidiaries in the United States and/or other countries. onsemi reserves the right to make changes without further notice to any products herein. onsemi makes no warranty, representation or guarantee regarding the suitability of its products for any particular purpose, nor does onsemi assume any liability arising out of the application or use of any product or circuit, and specifically disclaims any and all liability, including without limitation special, consequential or incidental damages. onsemi does not convey any license under its patent rights nor the rights of others.

MECHANICAL CASE OUTLINE PACKAGE DIMENSIONS



PIM27, 71x37.4 (PRESSFIT PIN) CASE 180CP ISSUE A

DATE 20 DEC 2022

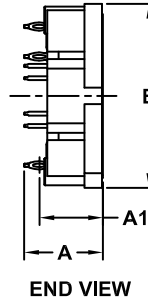
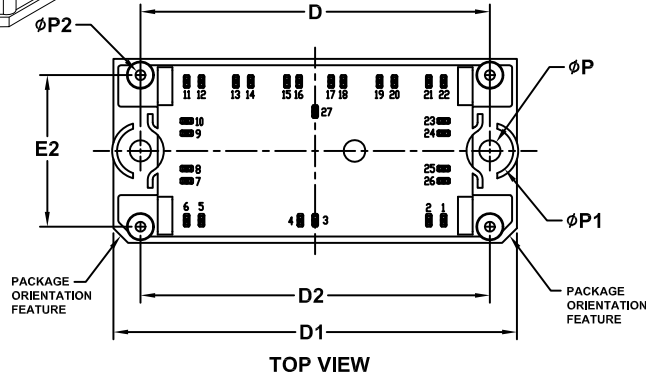
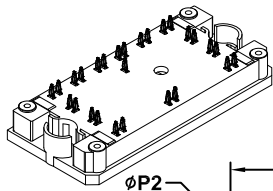

DIM	MILLIMETERS		
	MIN.	NOM.	MAX.
A	15.50	16.00	16.50
A1	12.38	12.88	13.38
A2	11.70	11.90	12.10
A3	0.00	0.20	0.60
b	1.61	1.66	1.71
b1	0.75	0.80	0.85
D	70.80	71.00	71.20
D1	81.70	82.00	82.30
D2	70.80	71.00	71.20
E	37.10	37.40	37.70
E2	30.60	30.80	31.00
P	4.10	4.30	4.50
P1	9.30	9.50	9.70
P2	1.80	2.00	2.20

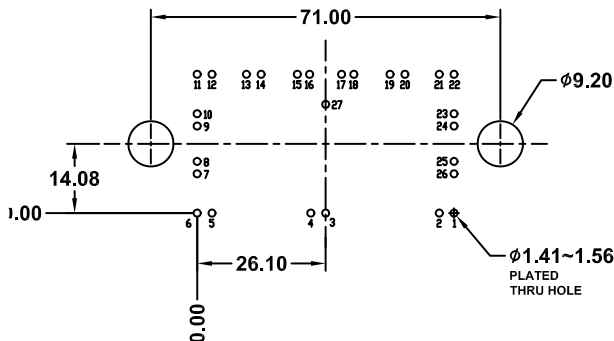
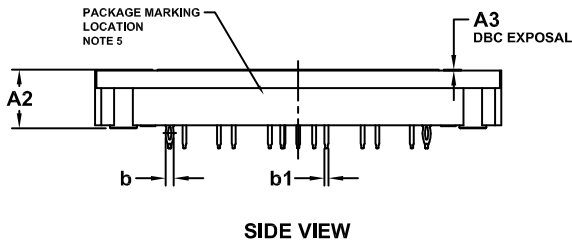

NOTE 4

PIN	PIN POSITION		PIN	PIN POSITION	
	X	Y		X	Y
1	52.20	0.00	15	20.35	28.20
2	49.20	0.00	16	22.85	28.20
3	26.10	0.00	17	29.35	28.20
4	23.10	0.00	18	31.85	28.20
5	3.00	0.00	19	39.20	28.20
6	0.00	0.00	20	42.20	28.20
7	0.00	8.00	21	49.20	28.20
8	0.00	10.50	22	52.20	28.20
9	0.00	17.70	23	52.20	20.20
10	0.00	20.20	24	52.20	17.70
11	0.00	28.20	25	52.20	10.50
12	3.00	28.20	26	52.20	8.00
13	10.00	28.20	27	26.10	22.10
14	13.00	28.20			

* For additional information on our Pb-Free strategy and soldering details, please download the ON Semiconductor Soldering and Mounting Techniques Reference Manual, SOLDERRM/D.

NOTES:

1. DIMENSIONING AND TOLERANCING PER ASME Y14.5M, 2009
2. CONTROLLING DIMENSION : MILLIMETERS
3. DIMENSIONS b AND b1 APPLY TO THE PLATED TERMINALS AND ARE MEASURED AT DIMENSION A1
4. PIN POSITION TOLERANCE IS $\pm 0.4\text{mm}$
5. PACKAGE MARKING IS LOCATED AS SHOWN ON THE SIDE OPPOSITE THE PACKAGE ORIENTATION FEATURES

GENERIC MARKING DIAGRAM*

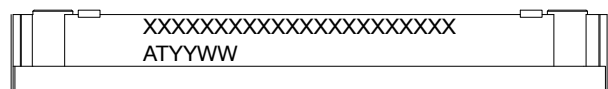

XXXXX = Specific Device Code
AT = Assembly & Test Site Code
YYWW = Year and Work Week Code

*This information is generic. Please refer to device data sheet for actual part marking. Pb-Free indicator, "G" or microdot "▪", may or may not be present. Some products may not follow the Generic Marking.

DOCUMENT NUMBER:	98AON26650H	Electronic versions are uncontrolled except when accessed directly from the Document Repository. Printed versions are uncontrolled except when stamped "CONTROLLED COPY" in red.
DESCRIPTION:	PIM27, 71X37.4 (PRESSFIT PIN)	PAGE 1 OF 1

onsemi and onsemi are trademarks of Semiconductor Components Industries, LLC dba onsemi or its subsidiaries in the United States and/or other countries. onsemi reserves the right to make changes without further notice to any products herein. onsemi makes no warranty, representation or guarantee regarding the suitability of its products for any particular purpose, nor does onsemi assume any liability arising out of the application or use of any product or circuit, and specifically disclaims any and all liability, including without limitation special, consequential or incidental damages. onsemi does not convey any license under its patent rights nor the rights of others.

onsemi, **Onsemi**, and other names, marks, and brands are registered and/or common law trademarks of Semiconductor Components Industries, LLC dba "**onsemi**" or its affiliates and/or subsidiaries in the United States and/or other countries. **onsemi** owns the rights to a number of patents, trademarks, copyrights, trade secrets, and other intellectual property. A listing of **onsemi**'s product/patent coverage may be accessed at www.onsemi.com/site/pdf/Patent-Marking.pdf. **onsemi** reserves the right to make changes at any time to any products or information herein, without notice. The information herein is provided "as-is" and **onsemi** makes no warranty, representation or guarantee regarding the accuracy of the information, product features, availability, functionality, or suitability of its products for any particular purpose, nor does **onsemi** assume any liability arising out of the application or use of any product or circuit, and specifically disclaims any and all liability, including without limitation special, consequential or incidental damages. Buyer is responsible for its products and applications using **onsemi** products, including compliance with all laws, regulations and safety requirements or standards, regardless of any support or applications information provided by **onsemi**. "Typical" parameters which may be provided in **onsemi** data sheets and/or specifications can and do vary in different applications and actual performance may vary over time. All operating parameters, including "Typicals" must be validated for each customer application by customer's technical experts. **onsemi** does not convey any license under any of its intellectual property rights nor the rights of others. **onsemi** products are not designed, intended, or authorized for use as a critical component in life support systems or any FDA Class 3 medical devices or medical devices with a same or similar classification in a foreign jurisdiction or any devices intended for implantation in the human body. Should Buyer purchase or use **onsemi** products for any such unintended or unauthorized application, Buyer shall indemnify and hold **onsemi** and its officers, employees, subsidiaries, affiliates, and distributors harmless against all claims, costs, damages, and expenses, and reasonable attorney fees arising out of, directly or indirectly, any claim of personal injury or death associated with such unintended or unauthorized use, even if such claim alleges that **onsemi** was negligent regarding the design or manufacture of the part. **onsemi** is an Equal Opportunity/Affirmative Action Employer. This literature is subject to all applicable copyright laws and is not for resale in any manner.

PUBLICATION ORDERING INFORMATION

LITERATURE FULFILLMENT:

Email Requests to: orderlit@onsemi.com

onsemi Website: www.onsemi.com

TECHNICAL SUPPORT

North American Technical Support:

Voice Mail: 1 800-282-9855 Toll Free USA/Canada

Phone: 011 421 33 790 2910

Europe, Middle East and Africa Technical Support:

Phone: 00421 33 790 2910

For additional information, please contact your local Sales Representative