



The Future of Analog IC Technology®

MP1529

Fixed Frequency Step-Up Converter LCD Backlight Plus Flash

DESCRIPTION

The MP1529 is a step-up converter for driving two 6-LED backlight strings to 30mA and a 4-LED flash string to 150mA from a single Lithium-Ion battery.

The step-up converter generates an output voltage as high as 25V from a 2.7V to 5.5V input source. Three current sources drive in three modes. In backlight mode two strings of 6 LEDs are lit with up to 30mA of current. In the backlight plus preview mode the 4 flash LEDs are lit with the preview current. In flash mode the flash LEDs are lit with up to 150mA of current and the two backlight strings are turned off. There are three pins to independently set the backlight, preview and flash current.

The MP1529 includes built-in open lamp over voltage protection, cycle-by-cycle current limit, over temperature shutdown, input under voltage control and integrated soft-start.

The MP1529 is available in a tiny 16-pin 4mm x 4mm package.

FEATURES

- 2.7V to 5.5V Input Voltage Range
- 25V Maximum Step-Up Voltage
- $1\mu\text{A}$ Shutdown Mode
- 1.2MHz Fixed Frequency Operation
- LCD Backlight to 30mA, Flash to 150mA
- Cycle-By-Cycle Current Limit
- Independent Backlight, Preview and Flash Current Adjustment
- Special PWM Dimming
- Over Voltage Protection
- Under Voltage Lockout
- Integrated Soft-Start
- Thermal Shutdown
- Tiny 4mm x 4mm QFN Package

APPLICATIONS

- PDAs
- Cellular Phones
- Digital Still Cameras
- Digital Video Cameras

"MPS" and "The Future of Analog IC Technology" are Registered Trademarks of Monolithic Power Systems, Inc.

TYPICAL APPLICATION

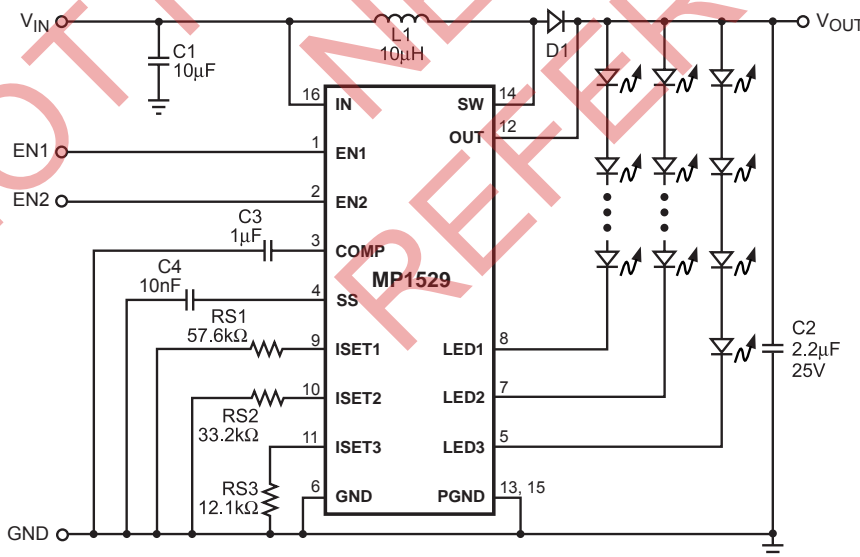

Efficiency vs LED Current
(Backlight Mode, 2 Strings of 3 LEDs)

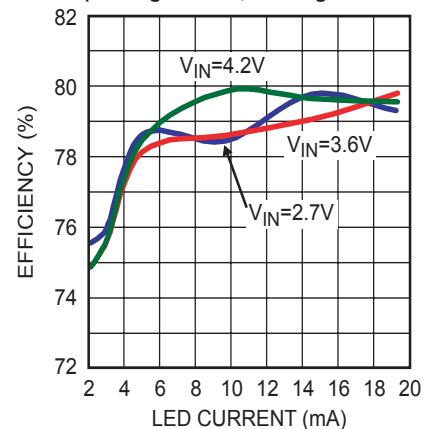

MP1529_EC01

PACKAGE REFERENCE

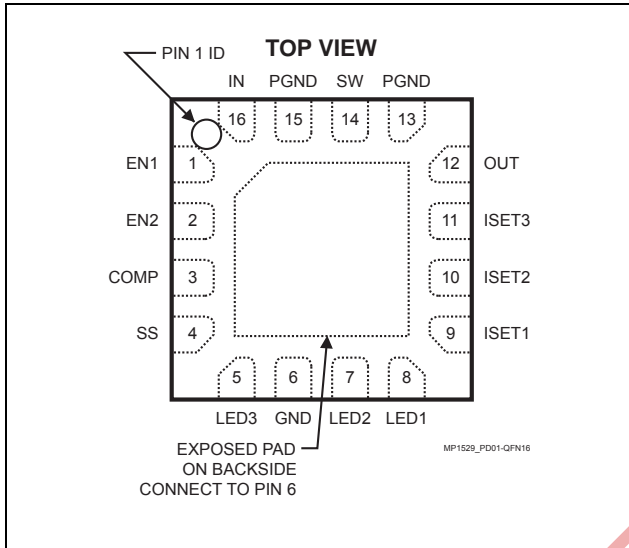

Part Number*	Package	Temperature
MP1529DR	QFN16 (4mm x 4mm)	-40°C to +85°C

* For Tape & Reel, add suffix -Z (eg. MP1529DR-Z)
For Lead Free, add suffix -LF (eg. MP1529DR-LF-Z)

ABSOLUTE MAXIMUM RATINGS ⁽¹⁾

V_{IN} -0.3V to +6V
 V_{SW} , V_{OUT} , V_{LED1} , V_{LED2} , V_{LED3} -1V to +40V
 All Other Pins -0.3V to +6V
 Junction Temperature 125°C
 Lead Temperature 260°C
 Storage Temperature -65°C to +150°C

Recommended Operating Conditions ⁽²⁾

Supply Voltage V_{IN} 2.7V to 5.5V
 LED Current (Backlight) 30mA Maximum
 LED Current (Flash) 150mA Maximum
 Operating Temperature -40°C to +85°C

Thermal Resistance ⁽³⁾ θ_{JA} θ_{JC}
 QFN16 (4mm x 4mm) 46 10... °C/W

Notes:

- 1) Exceeding these ratings may damage the device.
- 2) The device is not guaranteed to function outside of its operating conditions.
- 3) Measured on approximately 1" square of 1 oz copper.

ELECTRICAL CHARACTERISTICS

$V_{IN} = 3.6V$, $T_A = +25^\circ C$, unless otherwise noted.

Parameter	Symbol	Condition	Min	Typ	Max	Units
Shutdown Supply Current		$V_{EN1} = V_{EN2} = 0V$		0.5	1	μA
Supply Current		$V_{EN1} = 3V$, $V_{EN2} = 0V$, BL mode without switching		1.5	3	mA
Under Voltage Lockout		V_{IN} Rising	2.0		2.6	V
Under Voltage Lockout Hysteresis				210		mV
OUT Over Voltage Threshold				28		V
OUT Leakage Current		$V_{OUT} = 28V$, $V_{EN1} = V_{EN2} = 0V$			1	μA
ISET1 Backlight Current Gain		$I_{LED1,2} = 20mA$		0.95		mA/ μA
ISET2 Preview Current Gain		$I_{LED3} = 40mA$		1.1		mA/ μA
ISET3 Flash Current Gain		$I_{LED3} = 100mA$		1		mA/ μA
ISET1, ISET2 and ISET3 Voltage		$I_{ISET1,2,3} = 20\mu A$		1.216		V
LED1 and LED2 Voltage		$I_{LED1,2} = 20mA$		440		mV
LED3 Voltage		$I_{LED3} = 100mA$		480		mV
SW Switch On Resistance				0.25		Ω
SW Switch Leakage Current		$V_{EN1} = V_{EN2} = 0V$ $V_{SW} = 27V$			1	μA
SW Switch Current Limit				1.2		A
Current Sense to COMP Transconductance		$\Delta I_C = \pm 10\mu A$		200		$\mu A/V$

ELECTRICAL CHARACTERISTICS *(continued)*

$V_{IN} = 3.6V$, $T_A = +25^{\circ}C$, unless otherwise noted.

Parameter	Symbol	Condition	Min	Typ	Max	Units
Oscillation Frequency			1.0	1.2	1.4	MHz
SW Maximum Duty Cycle				95		%
EN1, EN2 High Voltage					1.4	V
EN1, EN2 Low Voltage			0.3			V
EN1, EN2 Turn-Off Delay to Shutdown ⁽⁴⁾		$C_{SS} = 16nF$		10		ms
EN1 Start-up Delay to Active Mode				4.8	8	μs
EN1 PWM Frequency ⁽⁴⁾		$C_{SS} = 16nF$	1		50	KHz
Soft-Start Period ⁽⁴⁾		$C_{SS} = 16nF$		10		ms
Thermal Shutdown				160		$^{\circ}C$

Note:

4) The soft-start timer and the PWM timer are the same timer with the same timing.

PIN FUNCTIONS

Pin #	Name	Description
1	EN1	Enable Input. See Table 1 for PWM serial interface usage. EN1 has an internal pull-down of 1.2M Ω .
2	EN2	Enable Input. See Table 1 for PWM serial interface usage. EN2 has an internal pull-down of 1.2M Ω .
3	COMP	Control Loop Compensation Node. COMP is the output of the internal transconductance amplifier. Connect a series resistor-capacitor network between COMP and GND to compensate the control loop.
4	SS	Soft-Start Capacitor Pin. Doubles as the PWM timer.
5	LED3	Number 3 LED String Current Control Input. Connect the bottom (Cathode) of the Number 3 LED string to LED3. This string is the flash string.
6	GND	Analog Ground. (Connect the Exposed Pad to Pin 6)
7	LED2	Number 2 LED String Current Control Input. Connect the bottom (Cathode) of the Number 2 LED string to LED2. This string is the backlight string.
8	LED1	Number 1 LED String Current Control Input. Connect the bottom (Cathode) of the Number 1 LED string to LED1. This string is the backlight string.
9	ISET1	Current Control Input. Connect a resistor between ISET1 and GND to set the backlight LED string current up to 30mA.
10	ISET2	Current Control Input. Connect a resistor between ISET2 and GND to set the flash LED string preview current up to 150mA.
11	ISET3	Current Control Input. Connect a resistor between ISET3 and GND to set the flash LED string current up to 150mA.
12	OUT	Output Voltage Sensing Input. When the OUT pin voltage exceeds the overvoltage threshold, the MP1529 automatically shuts down to prevent internal damage. Connect OUT to the output of the step-up converter.
14	SW	Switch Output. SW is the drain of the internal N-Channel MOSFET switch. Connect the power inductor between SW and the input source, and connect the output rectifier between SW and the output to form the step-up converter.
16	IN	Input Supply Pin. Must be locally bypassed.
13,15	PGND	Power Ground.

TYPICAL PERFORMANCE CHARACTERISTICS

Circuit of Figure 2, $V_{IN} = 3.6V$, 3 LEDs on LED1, 3 LEDs on LED2, 3 LEDs on LED3, $I_{LED_BL} = 20mA$, $I_{LED_PV} = 40mA$, $I_{LED_FL} = 100mA$, unless otherwise noted.

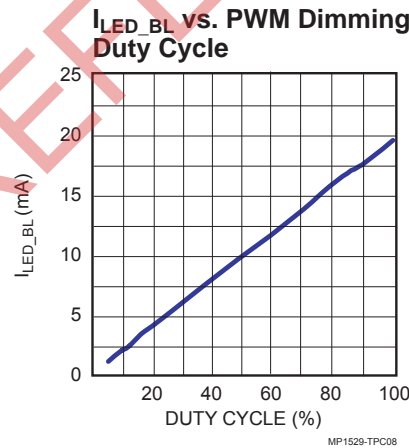
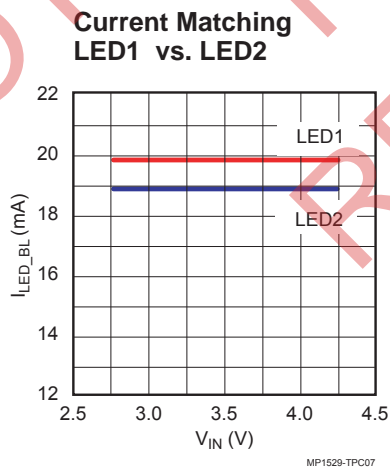
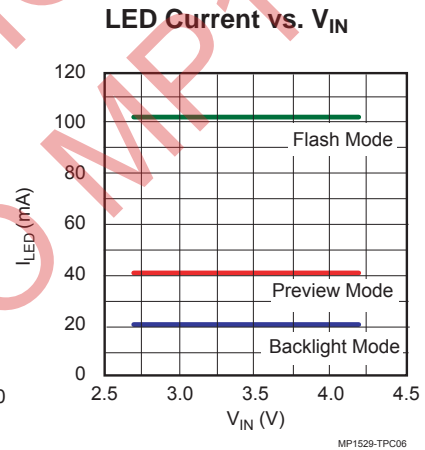
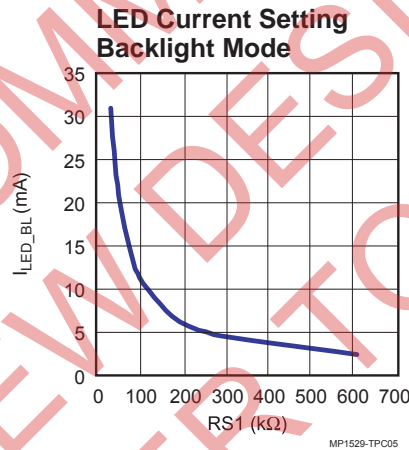
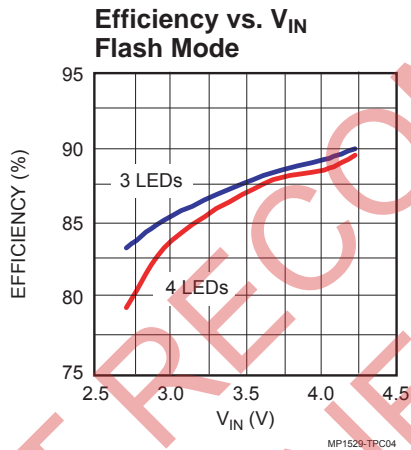
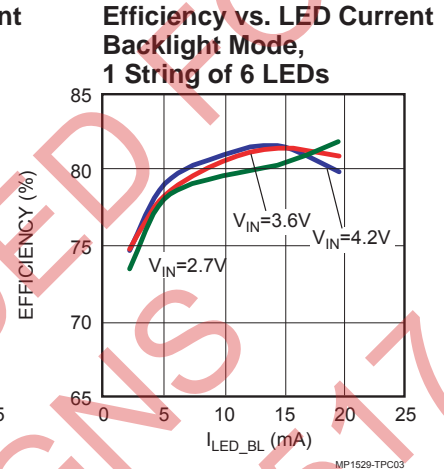
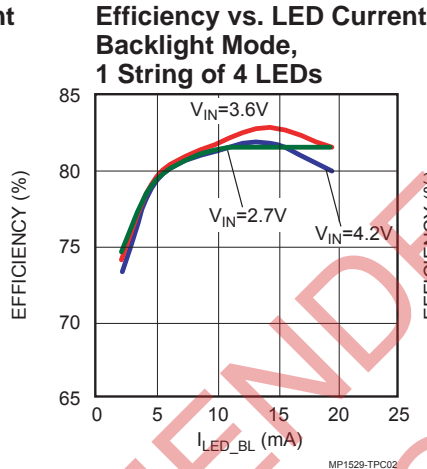
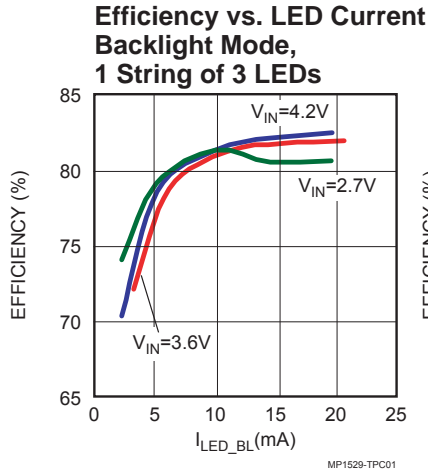

TYPICAL PERFORMANCE CHARACTERISTICS *(continued)*

Circuit of Figure 2, $V_{IN} = 3.6V$, 3 LEDs on LED1, 3 LEDs on LED2, 3 LEDs on LED3, $I_{LED_BL} = 20mA$, $I_{LED_PV} = 40mA$, $I_{LED_FL} = 100mA$, unless otherwise noted.

Steady State Operation Backlight Mode

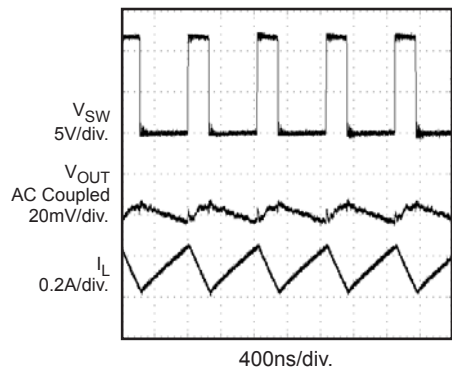

Steady State Operation Backlight plus Preview Mode

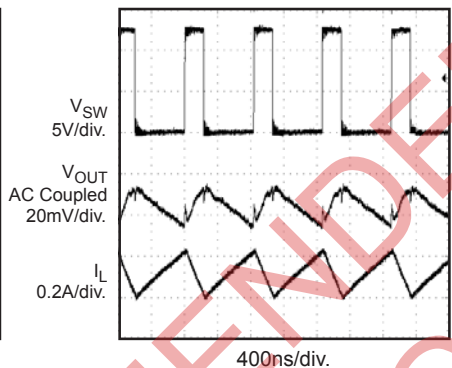

Steady State Operation Flash Mode

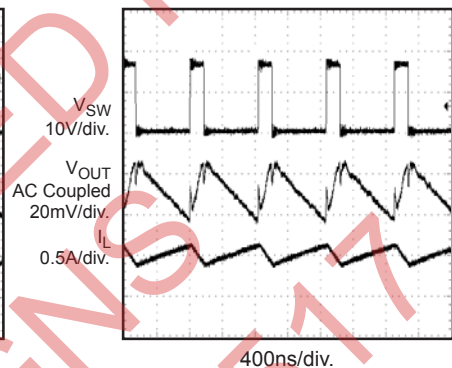

Start-up into Open LEDs

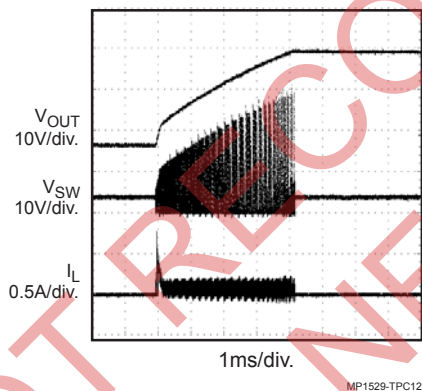

BLOCK DIAGRAM

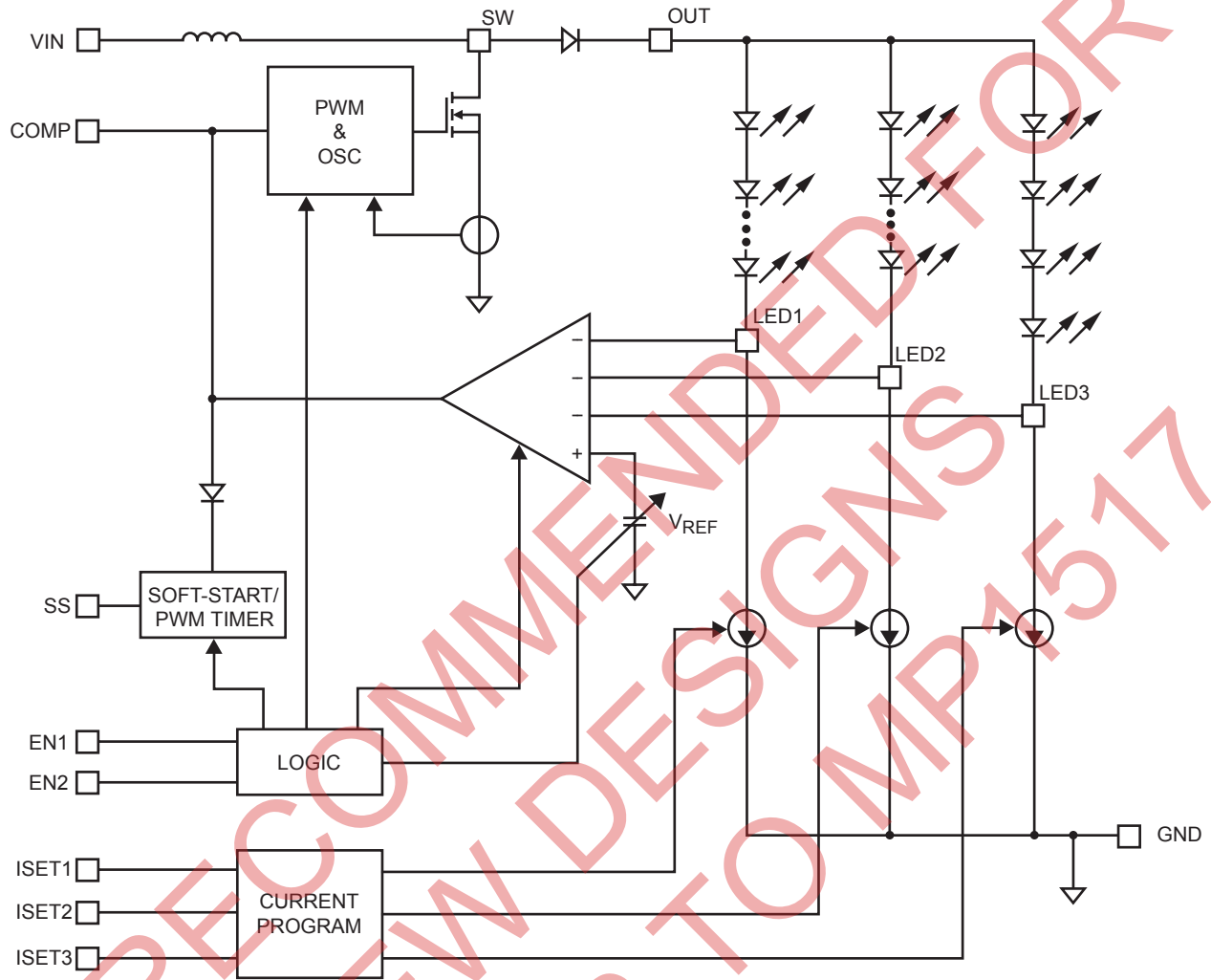

MP1529_F01_DB01

Figure 1—Functional Block Diagram

OPERATION

The MP1529 white LED driver performs both dual string backlight and single string flash functions for portable applications. Its features include pulse width modulated (PWM) dimming of the backlight LEDs to 30mA, preview with the same dimming capability on the backlight strings and a flash only mode to 150mA. Preview allows the flash LEDs to illuminate the camera scene such that the correct exposure setting can be set.

Startup and Shutdown

EN1 and EN2 are the enables for the backlight strings and the flash string, respectively. When the inputs are low, the part is either in shutdown mode or on the way to shutdown. The shutdown behavior will be discussed later.

Upon enabling the MP1529, the SS pin ramps its voltage to provide soft-start protection against supply inrush current. Typically the ramps last 1ms to 10ms, depending on capacitor selection. EN1 high lights up the LED1 and LED2 strings for the backlight application. The current setting is 950 times the current in ISET1 for each of the two backlight strings. Both EN1 and EN2 high together turn on the backlight strings and the preview mode in the flash string. The preview mode current is 1100 times the current in ISET2. The final setting depends on the PWM timer, which is the soft-start timer after soft-startup.

PWM Brightness Adjust

The PWM timer provides continuous operation of the flash string and other internal functions when the PWM low interval of EN1 is shorter than the PWM timing.

If the low interval is longer than the timer interval, the EN1 pin will assume a steady state low value. For example: when the PWM timing is too slow on EN1, it will result in the part turning off or entering flash mode (depending on the state of EN2).

EN2 uniquely affects this mode by resetting the PWM timer each time EN2 changes state. This allows a user to make a transition from preview to flash by passing through the off state. The change in EN2 resets the PWM and causes the flash to react immediately. Another method (though slower) to accomplish this is to stop the PWM timer and make a low transition on EN1 in the preview mode and to wait for the PWM timer to clear for flash mode. The time for this method is that of the PWM timer, which is the same as the SS timer.

Other features of the 1529 are constant frequency operation with cycle-by-cycle current limit as well as over-voltage and over temperature protection.

Open String Protection

There is also open string protection through the over-voltage protection that prevents the 1529 from trying to start an open string indefinitely. The over voltage signal forces the part to forget about open LED strings and to resume regulation on the remaining strings.

Initially, any open string will force the part to pump to its maximum voltage. At this point, the part will mark off strings that it simply cannot light properly. Once the mark-off operation completes, the remaining LED strings force the output voltage back into tight regulation. The string with the highest voltage drop is the ruling string during output regulation. Once a string is marked off, its current regulation cannot force the loop regulation to set the output voltage. Marked-off LED strings will continue to seek current regulation and may come into current regulation if their connections return or improve. However, the ability to light the string properly will vary due to the lack of output voltage control. The part will maintain mark-off information until the part shuts down or another LED string opens to force an over-voltage condition. Each time the over-voltage condition is triggered, the part marks off strings according to their ability to reach current regulation. The MP1529 will always try to light at least one string and will ignore the case wherein all the strings are marked off.

Table 1—Enable Operation Table (5, 6, 7)

Mode	EN1	EN2	Strings 1 & 2: LCD Backlight LEDs	String 3: Flash LEDs
Off	L	L	Off	Off
Backlight	H (PWM)	L	On (PWM)	Off
Backlight plus Preview	H (PWM)	H	On (PWM)	Preview current
Flash	L	H	Off	Flash current

Notes:

- 5) Backlight and Backlight plus Preview may use PWM for backlight brightness control. Only strings 1 & 2 will respond to high speed PWM. String 3 will remain continuously on or off depending on the mode.
- 6) Any combination of backlight string may be used. 1 or 2 or 1 & 2 will regulate properly. The part uses over voltage detection to determine which strings are available to light. The remaining strings are then used for regulation. The part will not remain in an open loop mode if there is at least one string of LEDs to light.
- 7) Changing from backlight plus preview to flash will have a delay equal to the soft-start timer due to the PWM filtering necessary for preview. Switching the part to off mode then to flash will cancel the timer. This will take a few microseconds instead of the 10 milliseconds typically associated with the timer being active.

APPLICATION INFORMATION

Setting the LED currents

Resistors RS1, RS2 and RS3 set the backlight LED string (LED1 and LED2) current, the flash LED string (LED3) preview current, and the flash LED string current, respectively. Determine each current setting resistor in kΩ by the equations:

$$RS1 = \frac{950 \times V_{SET}}{I_{LED_BL}}$$

$$RS2 = \frac{1100 \times V_{SET}}{I_{LED_PV}}$$

$$RS3 = \frac{1000 \times V_{SET}}{I_{LED_FL}}$$

Where V_{SET} is the internal reference voltage (typically 1.216V). I_{LED_BL} , I_{LED_PV} and I_{LED_FL} are the backlight LED string current, the flash LED string preview current, and the flash LED string flash current in mA, respectively.

Selecting the Input Capacitor

An input capacitor is required to supply the AC ripple current to the inductor, while limiting noise at the input source. Use a ceramic capacitor to maintain low ESR.

Use an input capacitor value of 4.7μF or greater. This capacitor must be placed physically close to the IN pin. Since it reduces the voltage ripple seen at IN, it also reduces the amount of EMI passed back along that line to the other circuitry.

Selecting the Output Capacitor

A single 1μF to 4.7μF ceramic capacitor usually provides sufficient output capacitance for most applications. The impedance of the ceramic capacitor at the switching frequency is dominated by the capacitance, and so the output voltage ripple is mostly independent of the ESR. The output voltage ripple V_{RIPPLE} is calculated as:

$$V_{RIPPLE} = \frac{I_{LED}(V_{OUT} - V_{IN})}{V_{OUT} \times C2 \times f_{SW}}$$

Where V_{OUT} is the output voltage, V_{IN} is the input voltage, I_{LED} is the total LED current, C2 is the capacitance of the output capacitor, and f_{SW} is the 1.2MHz switching frequency.

Selecting the Inductor

The inductor is required to force the output voltage higher while being driven by the lower input voltage. Choose an inductor that does not saturate at the SW current limit.

A good standard for determining the inductance is to allow the peak-to-peak ripple current to be approximately 30%-50% of the maximum input current, which usually occurs in flash mode. Make sure that the peak inductor current is below 75% of the typical current limit to prevent loss of regulation due to the current limit variation.

Calculate the required inductance value L using the equations:

$$L = \frac{V_{IN}(V_{OUT} - V_{IN})}{V_{OUT} \times f_{SW} \times \Delta I}$$

$$I_{IN(MAX)} = \frac{V_{OUT} \times I_{LED_FL}}{V_{IN} \times \eta}$$

$$\Delta I = (30\% - 50\%) I_{IN(MAX)}$$

Where ΔI is the peak-to-peak inductor ripple current and η is the efficiency at flash mode. A 4.7μH or 10μH inductor is recommended for most cell phone applications.

Selecting the Diode

The output rectifier diode supplies current to the inductor when the internal MOSFET is off. To reduce losses due to diode forward voltage and recovery time, use a Schottky diode.

Choose a diode whose maximum reverse voltage rating is greater than the maximum output voltage. For output voltage less than 20V, it is recommended to choose the MBR0520 for most applications.

Selecting the Compensation Capacitor

The compensation capacitor needs to be determined so that the control loop is slow enough to allow for stable and smooth mode transitions. A 1μF ceramic capacitor is recommended for most applications.

Selecting the Soft-Start Capacitor

The soft-start capacitor sets both the soft-start timer and the PWM timer. A 10nF to 22nF capacitor is recommended for most applications.

PWM Dimming Start up

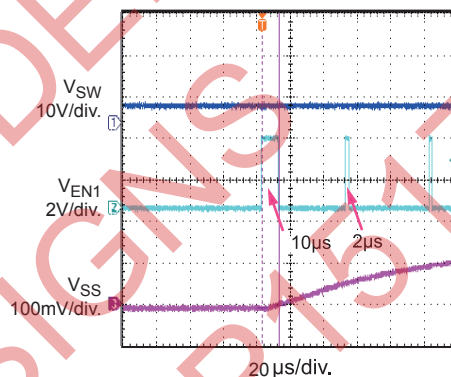

When MP1529 starts up under PWM Dimming mode, the first pulse width of EN1 is required to be more than 8μs to wake up the part. The pulse width can be as low as 2μs after MP1529 is active.

Layout Considerations

High frequency switching regulators require very careful layout for stable operation and low noise. All components must be placed as close to the IC as possible. Keep the path between the SW pin, output diode, output capacitor and GND pin extremely short for minimal noise and ringing. The input capacitor must be placed close to the IN pin for best decoupling. All current setting resistors must be kept close to the corresponding ISET pin to prevent noise injection for accurate LED current setting. The ground return of the input and output capacitors should be tied close to the GND pin. See the MP1529 demo board layout for reference.

TYPICAL APPLICATION CIRCUITS

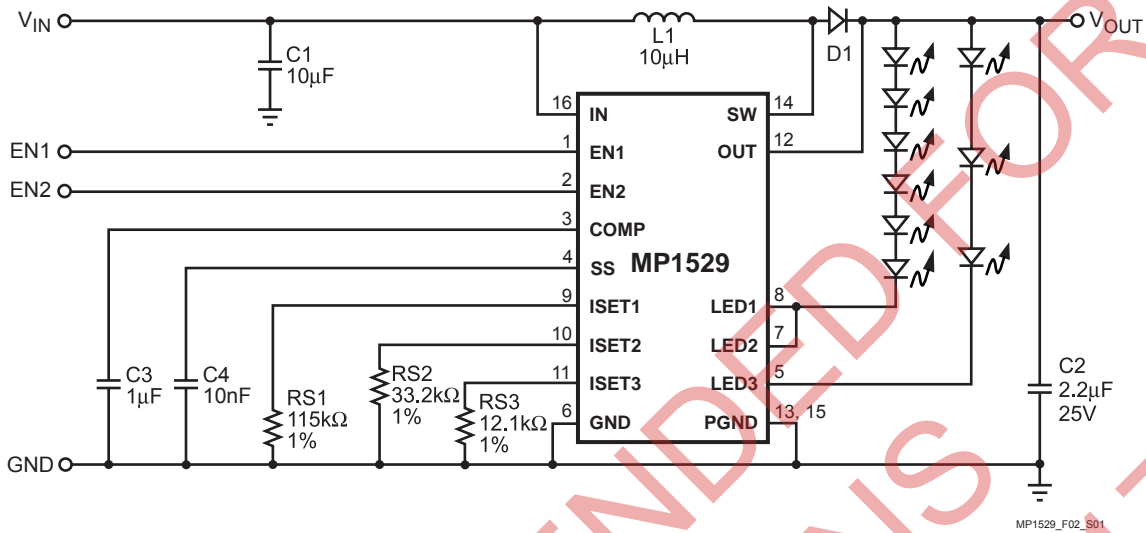

Figure 2— Driving 1 Backlight String (20mA per WLED) and 1 Flash String (40mA Preview, 100mA Flash)

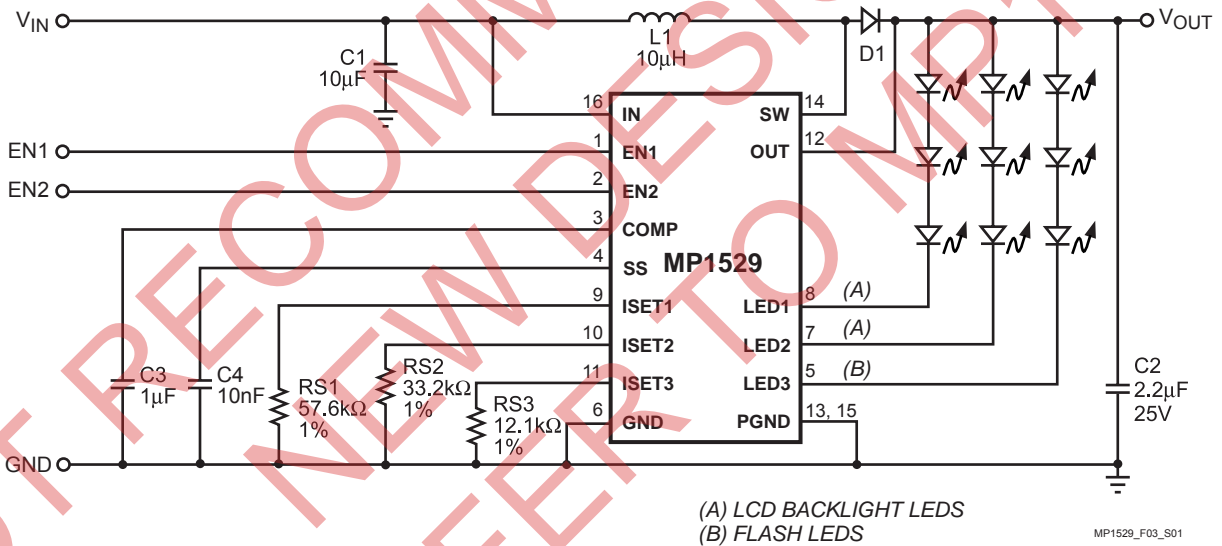

Figure 3—Driving 2 x 3 Backlight Strings (20mA per WLED) and 1 Flash String (40mA Preview, 100mA Flash)

TYPICAL APPLICATION CIRCUITS (continued)

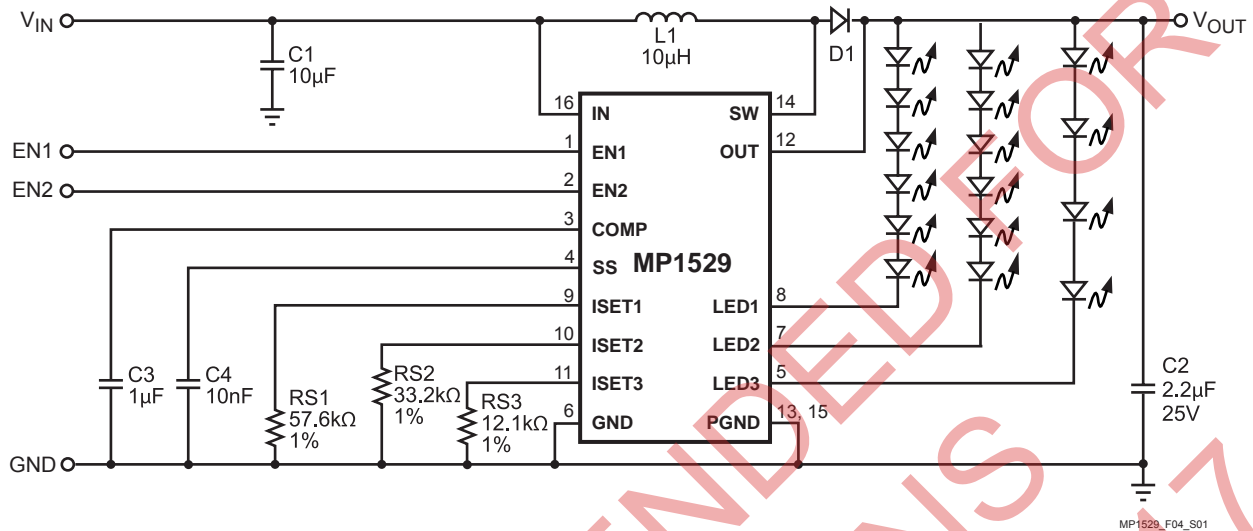
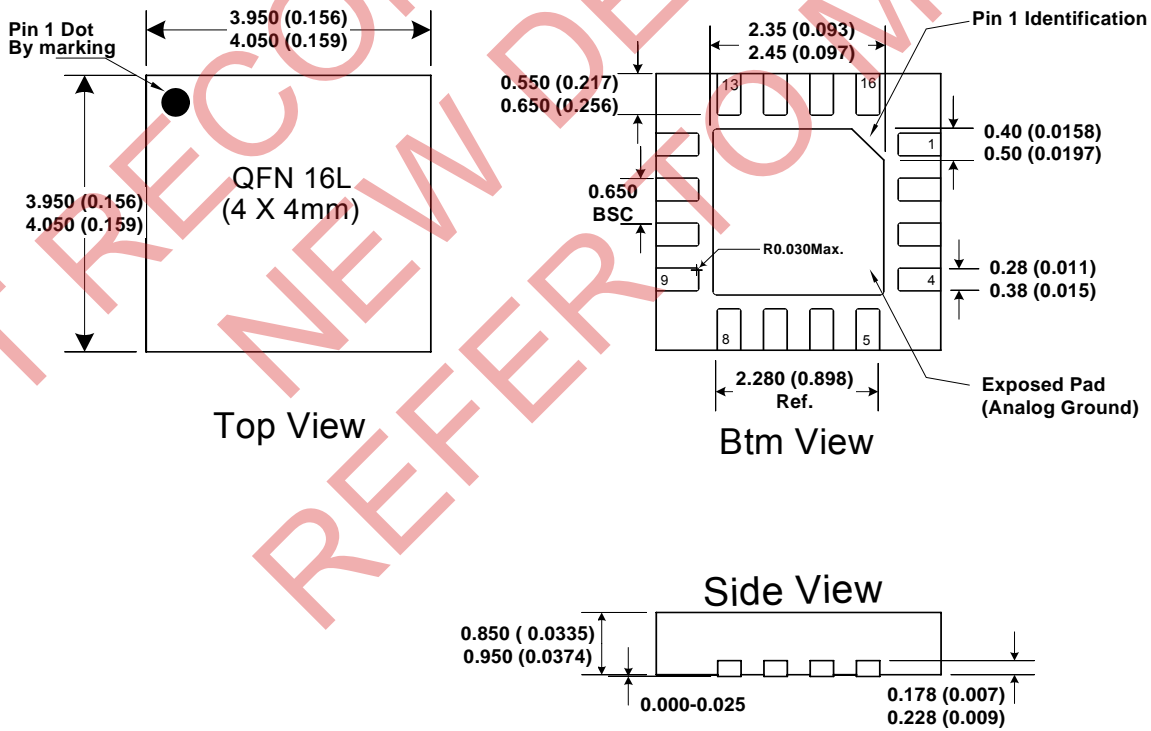

Figure 4—Driving 2 x 6 Backlight Strings (20mA per WLED) and 1 Flash String (40mA Preview, 100mA Flash)

PACKAGE INFORMATION

QFN16 (4mm x 4mm)



NOTICE: The information in this document is subject to change without notice. Please contact MPS for current specifications. Users should warrant and guarantee that third party Intellectual Property rights are not infringed upon when integrating MPS products into any application. MPS will not assume any legal responsibility for any said applications.