



EV3363-J-00A

Single String, 1.8V Vin-min, 36V Vout Boost LED Driver-Evaluation Board

DESCRIPTION

MP3363 is a fixed frequency converter ideal for low-to-high current Boost applications. The low 0.2V feedback voltage offers higher efficiency in white LED driver applications.

MP3363 regulates the output voltage up to 36V with efficiency as high as 95%. Current-mode regulation and external compensation components allow the MP3363 control loop to be optimized over a wide variety of input voltage.

MP3363 supports analog dimming and PWM dimming on same pin. The <2kHz input dimming frequency is for PWM dimming, >5kHz is for analog dimming.

Soft-start, cycle-by-cycle current limiting, and input under voltage lockout prevent overstressing or damage to sensitive external circuitry at startup and over load current conditions.

The MP3363 is available in a TSOT23-8 package.

ELECTRICAL SPECIFICATIONS

Parameter	Symbol	Value	Units
Input Voltage	V _{IN}	1.8 – 36	V
Output Voltage	V _{LED}	<40	V
LED String		1	string
LED Current	I _{LED}	40	mA

FEATURES

- Input Range of 1.8V to 36V
- 1A Peak Current Limit
- 0.5µA Shutdown Current
- Low 200mV Feedback Voltage
- Programmable Fsw 200kHz-2.2MHz
- Internal 100mΩ 40V Power Switch
- High Efficiency
- Analog and PWM Dimming
- Under Voltage Lockout Protection
- Open/Short LED Protection
- Short FB Protection
- Soft-Start Operation
- Thermal Shutdown
- TSOT23-8 Package

APPLICATIONS

- 2 AA Power Backlighting
- LCD Backlighting
- General Lighting

All MPS parts are lead-free, halogen-free, and adhere to the RoHS directive. For MPS green status, please visit the MPS website under Quality Assurance. "MPS", the MPS logo, and "Simple, Easy Solutions" are trademarks of Monolithic Power Systems, Inc. or its subsidiaries.

EVQ3362-J-00A EVALUATION BOARD

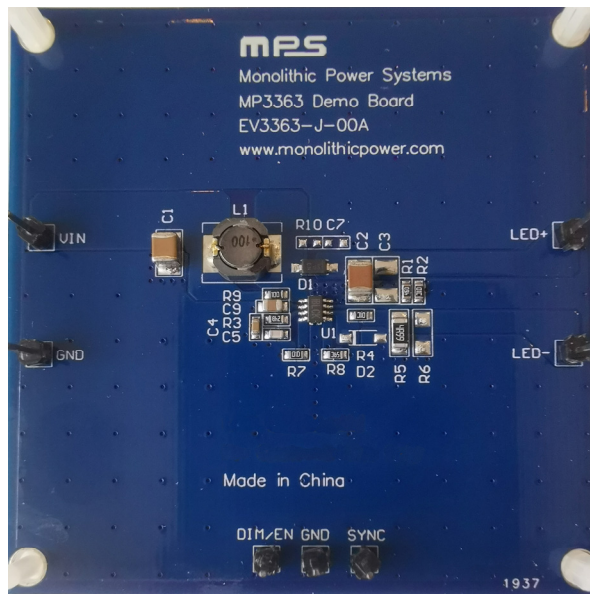

(L x W x H) 6.35cm x 6.35cm x 1.0cm

Board Number	MPS IC Number
EV3363-J-00A	MP3363GJ

QUICK START GUIDE

1. Preset DC Power Supply output to 1.8V to 36V and turn off Power Supply.
2. Connect the positive terminal of Power Supply output to the VIN pin and the negative terminal to the GND pin.
3. Connect the LED load between “LED+” (anode of LED string) and “LED-“(cathode of LED string).
4. Turn on Power Supply.
5. Apply the Enable voltage to the EN/DIM pin and drive Enable high to turn on the chip. Apply the PWM signal to then EN/DIM pin for realizing the Dimming function($F_{pwm} > 5\text{kHz}$ for Analog dimming, $F_{pwm} < 2\text{kHz}$ for PWM dimming).

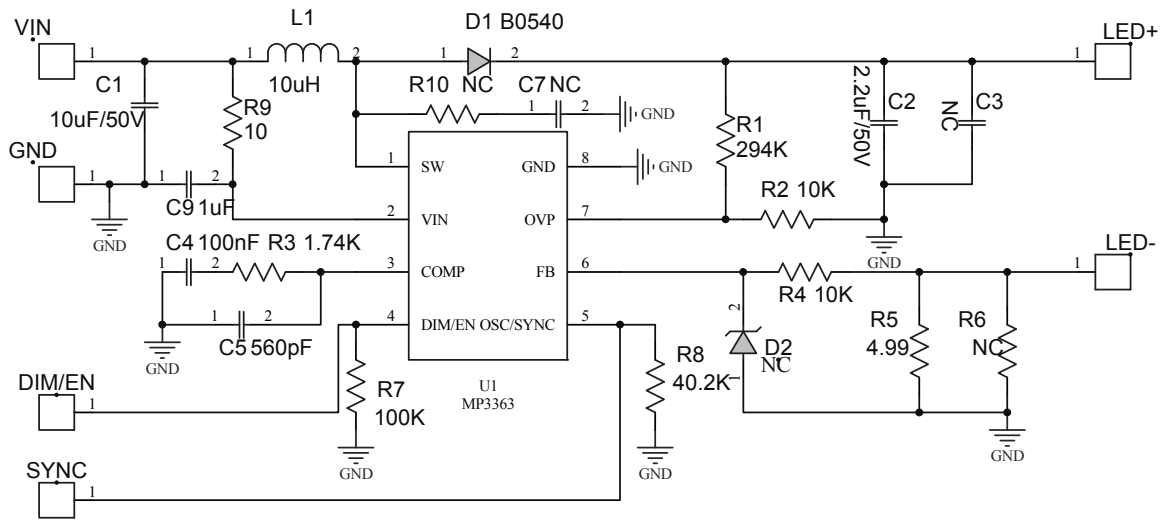
EVALUATION BOARD SCHEMATIC

EVQ3362-J-00A BILL OF MATERIALS

RefDes	Value	Description	Package	Manufacturer	Manufacturer_P/N
C1	10 μ F	Ceramic Capacitor; 50V;X7R;1210;	1210	TDK	C3225X7R1H106M
C2	2.2 μ F	Ceramic Capacitor; 50V;X7R;1210;	1210	muRata	GJ8319R61H225K
C4	100nF	Ceramic Capacitor; 25V;X7R;0603;	0603	Würth	8.85012E+11
C5	560pF	Ceramic Capacitor; 50V;X7R;0603;	0603	muRata	GRM1885C1H561JA01
C7,C3	NC				
C9	1 μ F	Ceramic Capacitor; 50V;X7R;0805;	0805	muRata	GRM21BR71H105KA12L
D1	B0540	40V/0.5A	SOD-123	Diodes	B0540W-7-F
D2	NC				
L1	10 μ H/1.14A	SUMIDA/CDRH3D16	SMD	TOKO	D63LCB-A921CY- 100M=P3
R1	294k	Film Resistor;1%;	0603	Yageo	RC0603FR-07294KL
R2,R4	10k	Film Resistor;1%;	0603	Yageo	RC0603FR-0710KL
R3	1.74k	Film Resistor;1%;	0603	Yageo	RC0603FR-071K74RL
R5	4.99	Film Resistor;1%;	1206	Yageo	RC1206FR-074R99L
R6,R10	NC				
R7	100k	Film Resistor;1%;	0603	Yageo	RC0603FR-07100KL
R8	40.2k	Film Resistor;1%;	0603	Yageo	RC0603FR-0740K2L
R9	10	Film Resistor;5%;	0603	Yageo	RC0603JR-0710RL
VIN,GND, LED+,LED-, DIM/EN,SYNC		Connector			Connector: 2.54mm 排针
U1		MP3363			

EVB TEST RESULTS

$V_{IN}=10V$, Load:10LEDs, $I_{LED}=80mA$, $L=4.7\mu H$, $T_a=25^{\circ}C$, unless otherwise noted.

Steady State

$V_{IN} = 1.8V$, Load: 3LEDs

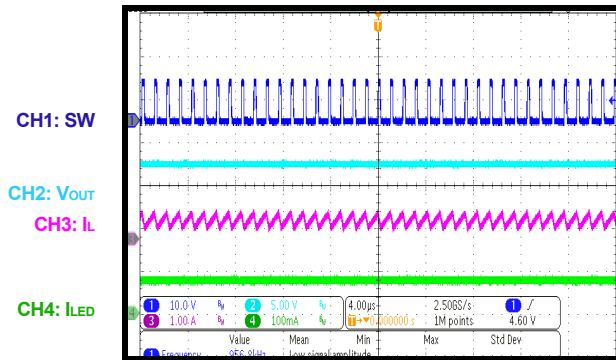

Steady State

Load: 6LEDs

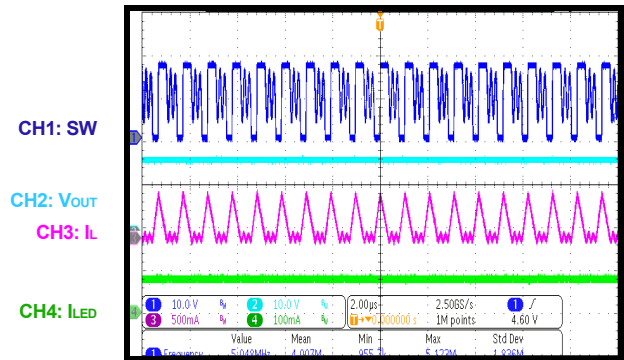

V_{IN} Power On

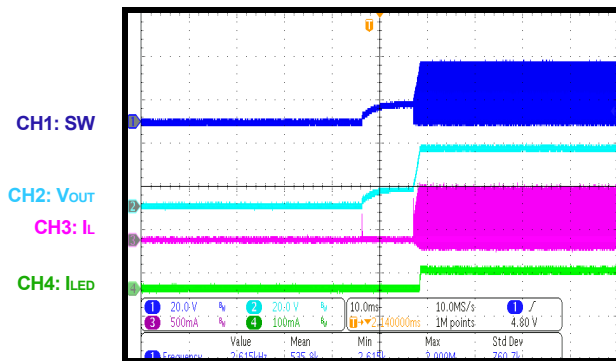

V_{IN} Power Off

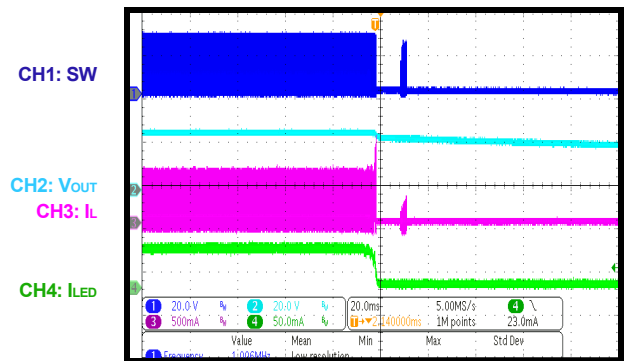

V_{EN} On

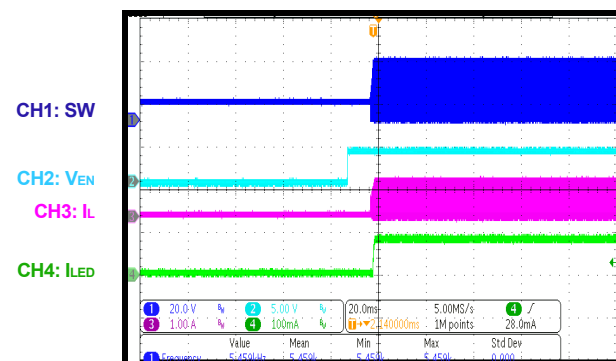

V_{EN} Off

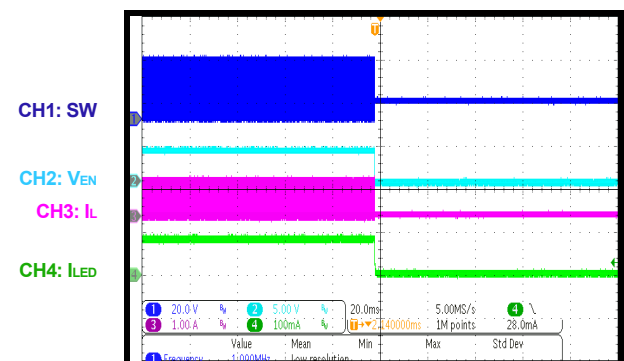

EVB TEST RESULTS (continued)

$V_{IN}=10V$, Load:10LEDs, $I_{LED}=80mA$, $L=4.7\mu H$, $T_a=25^\circ C$, unless otherwise noted.

PWM Power On
 $F_{PWM} = 10kHz(D=0.5)$

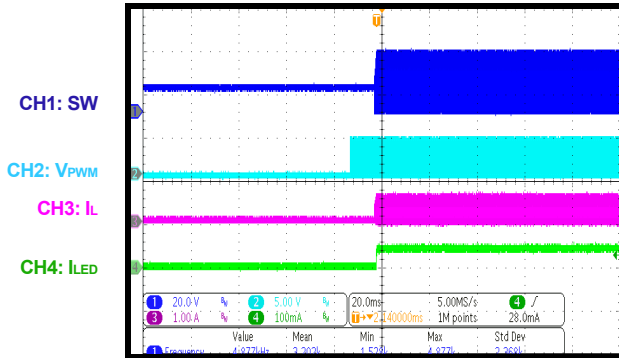

PWM Power Off
 $F_{PWM} = 10kHz(D=0.5)$

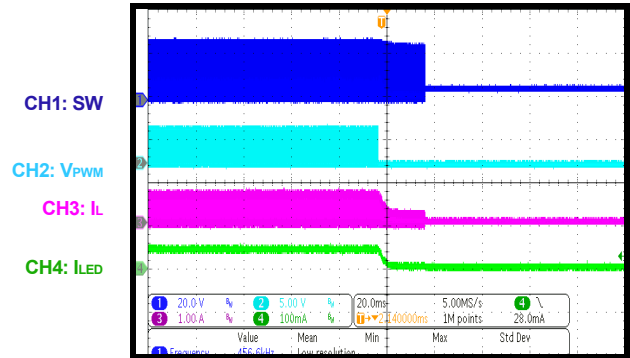

PWM Dimming
 $200Hz/D=0.5$

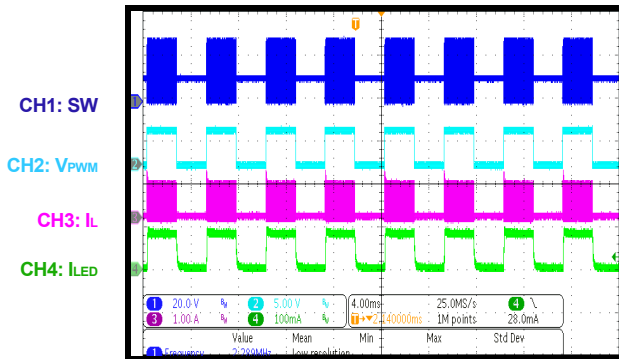

PWM Dimming
 $2kHz/D=0.5$

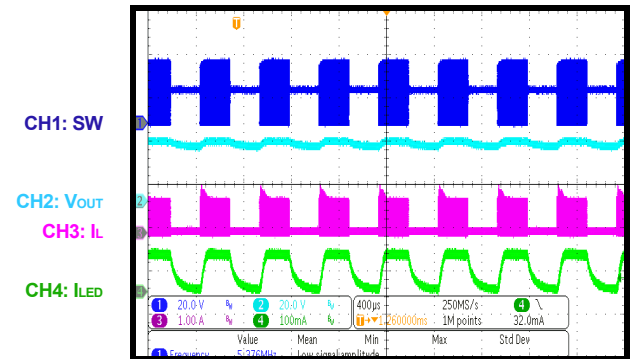

Analog Dimming
 $5kHz/D=0.5$

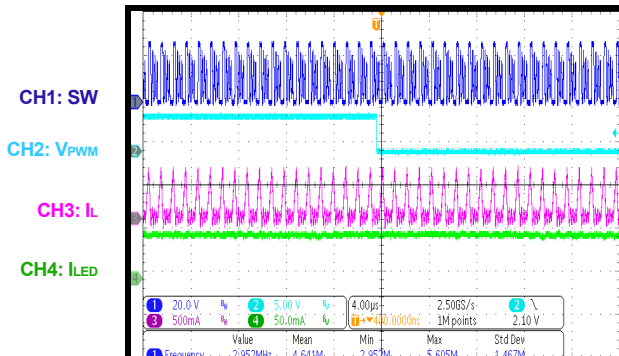

OVP When Work Normal

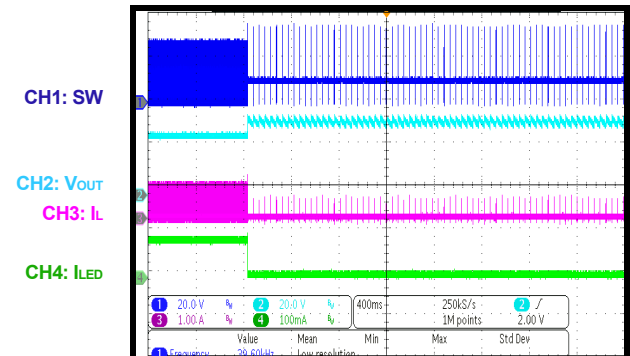

EVB TEST RESULTS *(continued)*

$V_{IN}=10V$, Load:10LEDs, $I_{LED}=80mA$, unless otherwise noted.

Short Inductor When Work Normal Then Recover

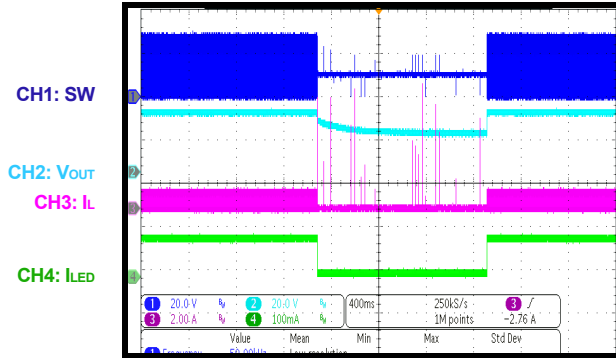

Short Diode When Work Normal Then Recover

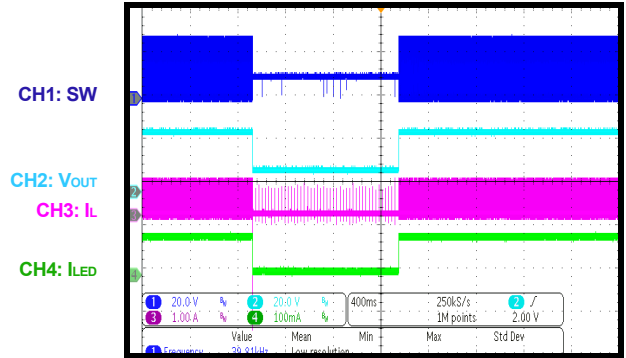

PRINTED CIRCUIT BOARD LAYOUT

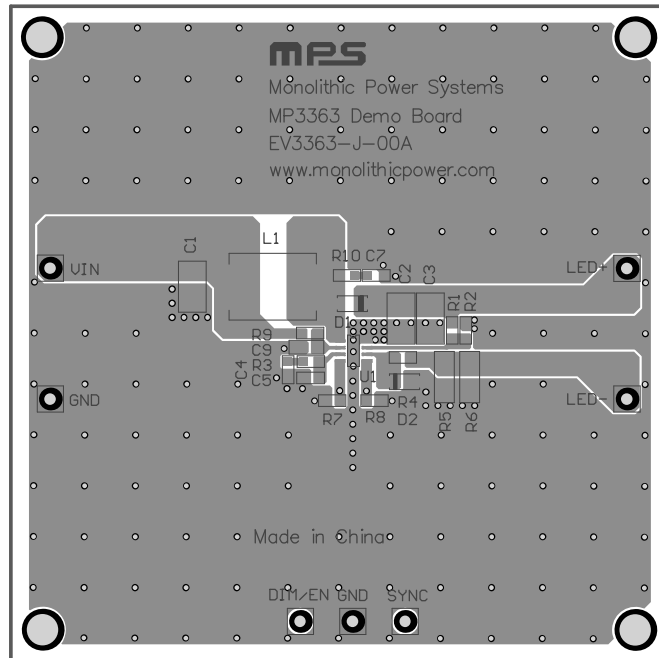

Figure 1: Top Layer

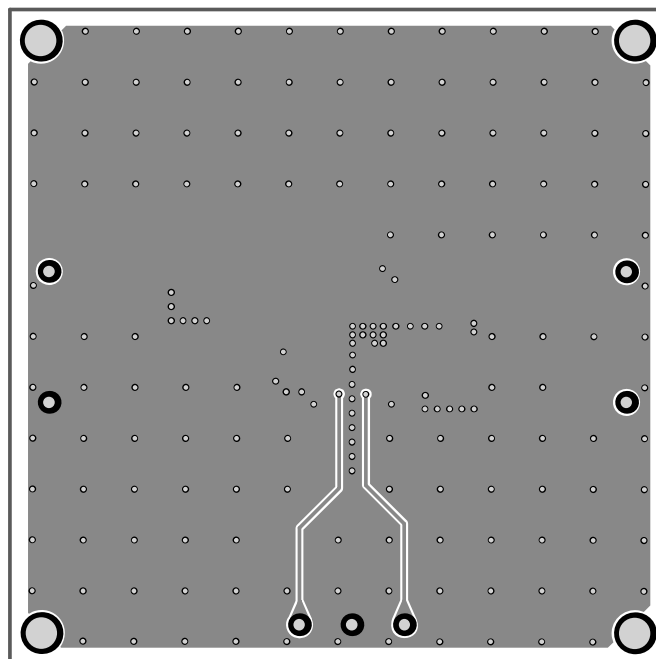

Figure 2: Bottom Layer

NOTICE: The information in this document is subject to change without notice. Please contact MPS for current specifications. Users should warrant and guarantee that third-party Intellectual Property rights are not infringed upon when integrating MPS products into any application. MPS will not assume any legal responsibility for any said applications.