

PNP Epitaxial Silicon Transistor

BSR16

PNP General Purpose Amplifier

- This Device Designed for Use as General Purpose Amplifier and Switches Requiring Collector Currents to 500 mA
- Sourced from Process 63
- See BCW68G for Characteristics

ABSOLUTE MAXIMUM RATINGS

($T_A = 25^\circ\text{C}$, unless otherwise specified.)

Symbol	Parameter	Value	Unit
V_{CEO}	Collector–Emitter Voltage	–60	V
V_{CBO}	Collector–Base Voltage	–60	V
V_{EBO}	Emitter–Base Voltage	–5.0	V
I_C	Collector Current – Continuous	–800	mA
T_J, T_{ST}	Operating and Storage Junction Temperature Range	–55 ~ +150	$^\circ\text{C}$

Stresses exceeding those listed in the Maximum Ratings table may damage the device. If any of these limits are exceeded, device functionality should not be assumed, damage may occur and reliability may be affected.

1. These ratings are based on a maximum junction temperature of 150°C .
2. These are steady state limits. The factory should be consulted on applications involving pulsed or low duty cycle operations.

THERMAL CHARACTERISTICS

($T_A = 25^\circ\text{C}$, unless otherwise specified)

Symbol	Parameter	Max.	Unit
P_D	Total Device Dissipation Derate above 25°C	350 2.8	mW mW/ $^\circ\text{C}$
$R_{\theta JA}$	Thermal Resistance, Junction to Ambient	357	$^\circ\text{C}/\text{W}$

3. Device mounted on FR–4 PCB $40\text{ mm} \times 40\text{ mm} \times 1.5\text{ mm}$.



ON Semiconductor®

www.onsemi.com

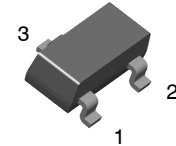

SOT–23
CASE 318BM

MARKING DIAGRAM

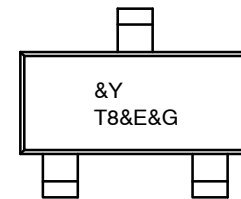

&Y ON Semiconductor Logo
T8 Specific Device Code
&E Designates Space
&G Date Code (Week)

PIN ASSIGNMENT

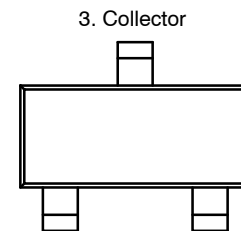

ORDERING INFORMATION

Device	Package	Shipping†
BSR16	SOT–23 (Pb–Free)	3,000 / Tape & Reel

†For information on tape and reel specifications, including part orientation and tape sizes, please refer to our Tape and Reel Packaging Specification Brochure, BRD8011/D.

BSR16

ELECTRICAL CHARACTERISTICS ($T_A = 25^\circ\text{C}$, unless otherwise specified)

Symbol	Parameter	Test Conditions	Min	Typ	Max	Unit
--------	-----------	-----------------	-----	-----	-----	------

OFF CHARACTERISTICS

$BV_{(BR)CEO}$	Collector–Emitter Breakdown Voltage	$I_C = -10\text{ mA}, I_B = 0$	-60			V
$BV_{(BR)CBO}$	Collector–Base Breakdown Voltage	$I_C = -100\ \mu\text{A}, I_E = 0$	-60			V
$BV_{(BR)EBO}$	Emitter–Base Breakdown Voltage	$I_E = -10\ \mu\text{A}, I_C = 0$	-5.0			V
I_{CBO}	Collector Cut–off Current	$V_{CB} = -50\text{ V}$ $V_{CB} = -50\text{ V}, T_A = 150^\circ\text{C}$			-10 -10	nA μA
I_{CEX}	Collector Cut–off Current	$V_{CE} = -30\text{ V}, V_{EB} = -0.5\text{ V}$			-50	nA
I_{BEX}	Reverse Base Current	$V_{CE} = -30\text{ V}, V_{EB} = -3.0\text{ V}$			-50	nA

ON CHARACTERISTICS

h_{FE}	DC Current Gain	$I_C = -0.1\text{ mA}, V_{CE} = -10\text{ V}$ $I_C = -1.0\text{ mA}, V_{CE} = -10\text{ V}$ $I_C = -10\text{ mA}, V_{CE} = -10\text{ V}$ $I_C = -150\text{ mA}, V_{CE} = -10\text{ V}$ $I_C = -500\text{ mA}, V_{CE} = -10\text{ V}$	75 100 100 100 50	300		
$V_{CE(sat)}$	Collector–Emitter Saturation Voltage	$I_C = -150\text{ mA}, I_B = -15\text{ mA}$ $I_C = -500\text{ mA}, I_B = -50\text{ mA}$			-0.4 -1.6	V
$V_{BE(sat)}$	Base–Emitter Saturation Voltage	$I_C = -150\text{ mA}, I_B = -15\text{ mA}$ $I_C = -500\text{ mA}, I_B = -50\text{ mA}$			-1.3 -2.6	V

SMALL SIGNAL CHARACTERISTICS

f_T	Current Gain Bandwidth Product	$I_C = -50\text{ mA}, V_{CE} = -20\text{ V},$ $f = 100\text{ MHz}, T_A = 25^\circ\text{C}$	200			MHz
C_{cb}	Output Capacitance	$V_{CB} = -10\text{ V}, I_E = 0, f = 1.0\text{ MHz}$			8.0	pF
C_{eb}	Emitter–Base Capacitance	$V_{CB} = -2.0\text{ V}, I_E = 0, f = 1.0\text{ MHz}$			30	pF

SWITCHING CHARACTERISTICS

t_{on}	Turn–On Time	$V_{CC} = -30\text{ V}, I_C = -150\text{ mA},$ $I_{B1} = -15\text{ mA}$			45	ns
t_d	Delay Time				10	ns
t_r	Rise Time				40	ns
t_{off}	Turn–Off Time	$V_{CC} = -6\text{ V}, I_C = -150\text{ mA},$ $I_{B1} = I_{B2} = -15\text{ mA}$			100	ns
t_s	Storage Time				80	ns
t_f	Fall Time				30	ns

Product parametric performance is indicated in the Electrical Characteristics for the listed test conditions, unless otherwise noted. Product performance may not be indicated by the Electrical Characteristics if operated under different conditions.

MECHANICAL CASE OUTLINE

PACKAGE DIMENSIONS



SOT-23
CASE 318BM
ISSUE A

DATE 01 SEP 2021

NOTES: UNLESS OTHERWISE SPECIFIED

- A) REFERENCE JEDEC REGISTRATION TO-236, VARIATION AB, ISSUE H.
- B) ALL DIMENSIONS ARE IN MILLIMETERS.
- C) DIMENSIONS ARE INCLUSIVE OF BURRS, MOLD FLASH AND TIE BAR EXTRUSIONS.
- D) DIMENSIONING AND TOLERANCING PER ASME Y14.5M - 2009.

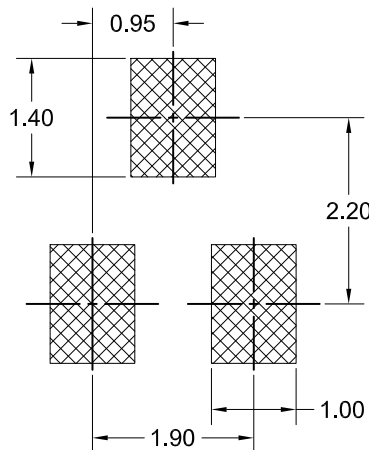
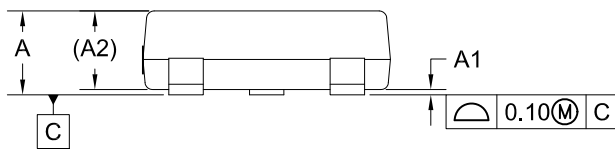
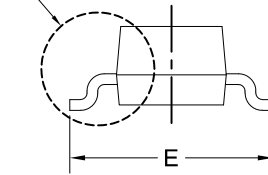
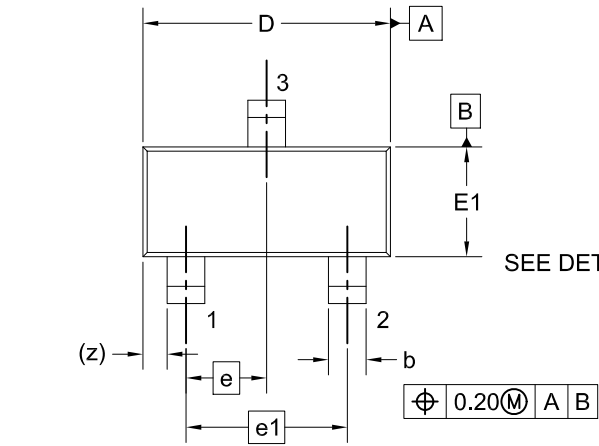

DIM	MILLIMETERS		
	MIN.	NOM.	MAX.
A	---	---	1.20
A1	0.00	0.05	0.10
A2	0.93 REF		
b	0.37	0.44	0.60
c	0.08	0.15	0.23
D	2.72	2.92	3.12
E	2.10	2.40	2.70
E1	1.15	1.30	1.50
e	0.95 BSC		
e1	1.90 BSC		
L	0.20	---	---
L1	0.55 REF		
z	0.29 REF		

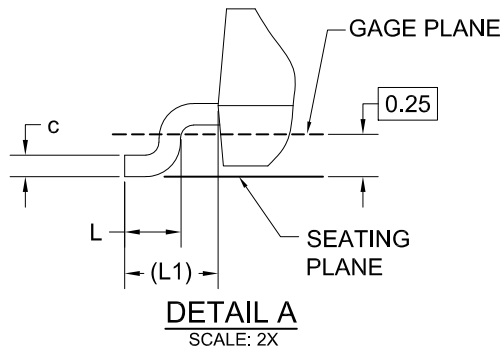

LAND PATTERN
 RECOMMENDATION

GENERIC MARKING DIAGRAM*

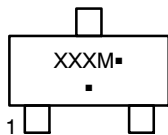

- XXX = Specific Device Code
- M = Date Code
- = Pb-Free Package

*This information is generic. Please refer to device data sheet for actual part marking. Pb-Free indicator, "G" or microdot "▪", may or may not be present. Some products may not follow the Generic Marking.

*FOR ADDITIONAL INFORMATION ON OUR PB-FREE STRATEGY AND SOLDERING DETAILS, PLEASE DOWNLOAD THE ON SEMICONDUCTOR SOLDERING AND MOUNTING TECHNIQUES REFERENCE MANUAL, SOLDERRM/D.

DOCUMENT NUMBER:	98AON13784G	Electronic versions are uncontrolled except when accessed directly from the Document Repository. Printed versions are uncontrolled except when stamped "CONTROLLED COPY" in red.
DESCRIPTION:	SOT-23	PAGE 1 OF 1

onsemi and ONSEMI are trademarks of Semiconductor Components Industries, LLC dba onsemi or its subsidiaries in the United States and/or other countries. onsemi reserves the right to make changes without further notice to any products herein. onsemi makes no warranty, representation or guarantee regarding the suitability of its products for any particular purpose, nor does onsemi assume any liability arising out of the application or use of any product or circuit, and specifically disclaims any and all liability, including without limitation special, consequential or incidental damages. onsemi does not convey any license under its patent rights nor the rights of others.

onsemi, **Onsemi**, and other names, marks, and brands are registered and/or common law trademarks of Semiconductor Components Industries, LLC dba "**onsemi**" or its affiliates and/or subsidiaries in the United States and/or other countries. **onsemi** owns the rights to a number of patents, trademarks, copyrights, trade secrets, and other intellectual property. A listing of **onsemi**'s product/patent coverage may be accessed at www.onsemi.com/site/pdf/Patent-Marking.pdf. **onsemi** reserves the right to make changes at any time to any products or information herein, without notice. The information herein is provided "as-is" and **onsemi** makes no warranty, representation or guarantee regarding the accuracy of the information, product features, availability, functionality, or suitability of its products for any particular purpose, nor does **onsemi** assume any liability arising out of the application or use of any product or circuit, and specifically disclaims any and all liability, including without limitation special, consequential or incidental damages. Buyer is responsible for its products and applications using **onsemi** products, including compliance with all laws, regulations and safety requirements or standards, regardless of any support or applications information provided by **onsemi**. "Typical" parameters which may be provided in **onsemi** data sheets and/or specifications can and do vary in different applications and actual performance may vary over time. All operating parameters, including "Typicals" must be validated for each customer application by customer's technical experts. **onsemi** does not convey any license under any of its intellectual property rights nor the rights of others. **onsemi** products are not designed, intended, or authorized for use as a critical component in life support systems or any FDA Class 3 medical devices or medical devices with a same or similar classification in a foreign jurisdiction or any devices intended for implantation in the human body. Should Buyer purchase or use **onsemi** products for any such unintended or unauthorized application, Buyer shall indemnify and hold **onsemi** and its officers, employees, subsidiaries, affiliates, and distributors harmless against all claims, costs, damages, and expenses, and reasonable attorney fees arising out of, directly or indirectly, any claim of personal injury or death associated with such unintended or unauthorized use, even if such claim alleges that **onsemi** was negligent regarding the design or manufacture of the part. **onsemi** is an Equal Opportunity/Affirmative Action Employer. This literature is subject to all applicable copyright laws and is not for resale in any manner.

PUBLICATION ORDERING INFORMATION

LITERATURE FULFILLMENT:

Email Requests to: orderlit@onsemi.com

onsemi Website: www.onsemi.com

TECHNICAL SUPPORT

North American Technical Support:

Voice Mail: 1 800-282-9855 Toll Free USA/Canada

Phone: 011 421 33 790 2910

Europe, Middle East and Africa Technical Support:

Phone: 00421 33 790 2910

For additional information, please contact your local Sales Representative