

EMI7403

EMI Filter with ESD Protection for MicroSD Card Applications

Product Description

The EMI7403 is a combination EMI filter with integrated TVS diodes for use on Multimedia Card interfaces. This state-of-the-art device utilizes solid-state, silicon-avalanche technology for superior clamping performance and DC electrical characteristics. The EMI7403 has been optimized for protection of MicroSD interfaces in smart phones and other portable electronics.

Features

- Provides ESD Protection to IEC61000-4-2: ±15 kV Contact Discharge
- Protection and Termination for 6 Lines + V_{CC}
- These Devices are Pb-Free, Halogen Free/BFR Free and are RoHS Compliant

Applications

- MicroSD Interfaces
- MMC Interfaces
- Feature Phones, Smart Phones

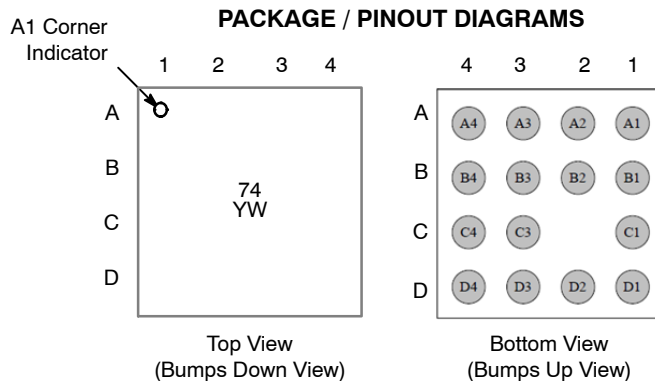

ON Semiconductor®

<http://onsemi.com>

MARKING DIAGRAM



**WLCSP15
CASE 567FX**

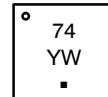

- 74 = Specific Device Code
- Y = Year
- W = Work Week
- = Pb-Free Package

ORDERING INFORMATION

Device	Package	Shipping†
EMI7403FCTBG	WLCSP15 (Pb-Free)	5000 / Tape & Reel

†For information on tape and reel specifications, including part orientation and tape sizes, please refer to our Tape and Reel Packaging Specifications Brochure, BRD8011/D.

EMI7403

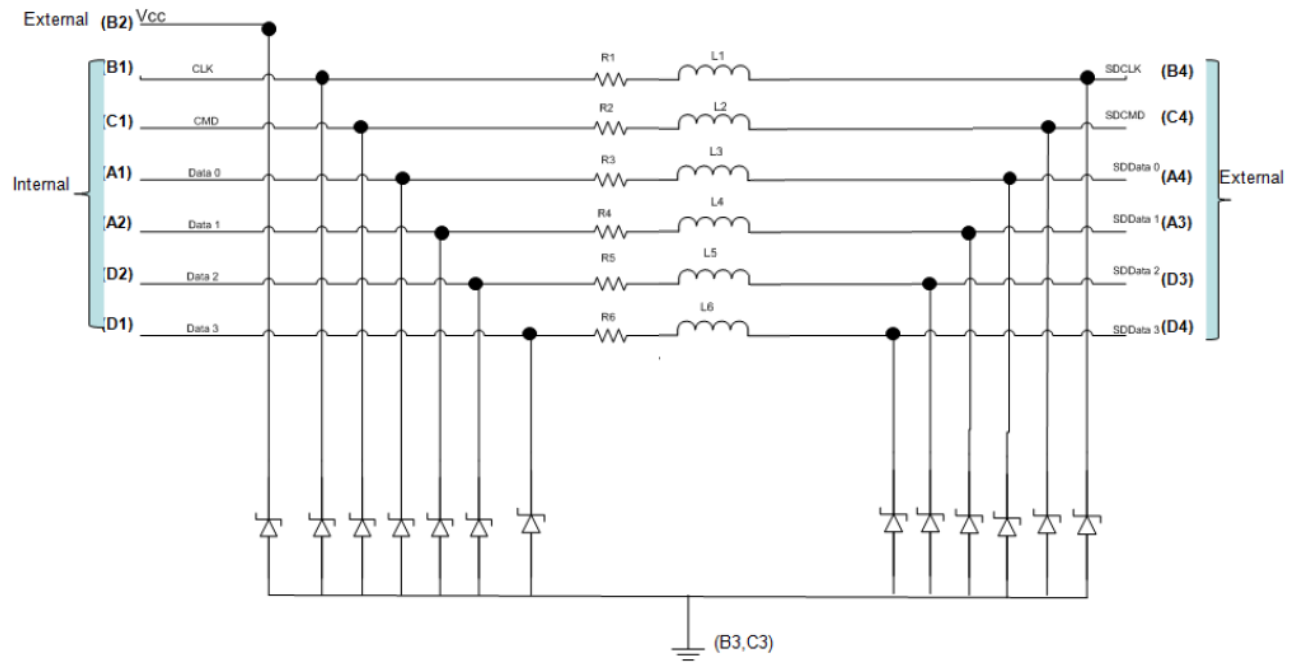

Figure 1. Electrical Schematic

Table 1. PIN DESCRIPTIONS

Pin	Description	Pin	Description	Pin	Description	Pin	Description
A1	data0 Internal	B1	clk Internal	C1	cmd Internal	D1	data3 Internal
A2	data1 Internal	B2	V _{CC} External			D2	data2 Internal
A3	SDdata1 External	B3	GND	C3	GND	D3	SDdata2 External
A4	SDdata0 External	B4	SDclk External	C4	SDcmd External	D4	SDdata3 External

EMI7403

ELECTRICAL SPECIFICATIONS AND CONDITIONS

Table 2. PARAMETERS AND OPERATING CONDITIONS

Parameter	Rating	Unit
Storage Temperature Range	-55 to +150	°C
Operating Temperature Range	-40 to +85	°C

Functional operation above the stresses listed in the Recommended Operating Ranges is not implied. Extended exposure to stresses beyond the Recommended Operating Ranges limits may affect device reliability.

ELECTRICAL CHARACTERISTICS (T_A = 25°C unless otherwise noted)

Symbol	Parameter	Test Conditions	Min	Typ	Max	Unit
V _{RWM}	Reverse Working Voltage	(Note 3)		3.3		V
V _{BR}	Breakdown Voltage	I _T = 1 mA; (Note 4)	6.0		9.0	V
I _{LEAK}	Channel Leakage Current	V _{IN} = 3.3 V		0.1	0.5	μA
R _{CH}	Channel Resistance (R1 to R6)			40		Ω
f _{3dB}	Cut-off Frequency	50 Ω Source and Load Termination		300		MHz
F _{atten}	Stop Band Attenuation	@ 700 MHz @ 900 MHz		20 35		dB
V _{ESD}	In-system ESD Withstand Voltage a) Contact discharge per IEC 61000-4-2 standard, Level 4 (External Pins) b) Contact discharge per IEC 61000-4-2 standard, Level 1 (Internal Pins)	(Notes 1 and 2)	±15 ±2			kV

Product parametric performance is indicated in the Electrical Characteristics for the listed test conditions, unless otherwise noted. Product performance may not be indicated by the Electrical Characteristics if operated under different conditions.

- Standard IEC61000-4-2 with C_{Discharge} = 150 pF, R_{Discharge} = 330, GND grounded.
- These measurements performed with no external capacitor.
- TVS devices are normally selected according to the working peak reverse voltage (V_{RWM}), which should be equal to or greater than the DC or continuous peak operating voltage level.
- V_{BR} is measured at pulse test current I_T.

EMI7403

RF CHARACTERISTICS

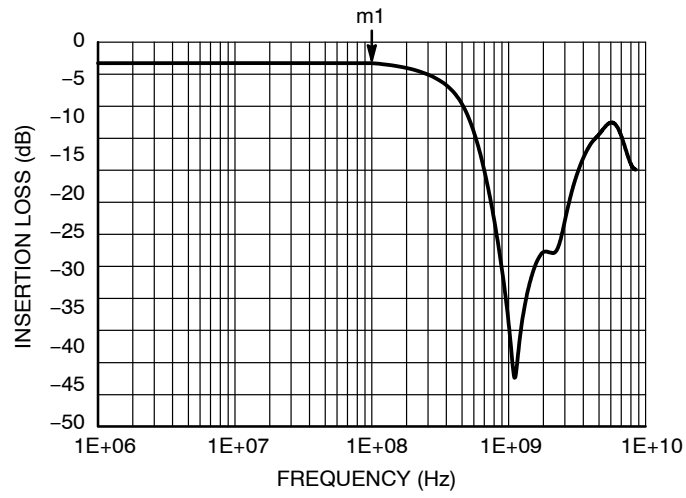

Figure 2. S21 Attenuation Simulation

Interface	Data Rate (Mbyte/s)	Fundamental Frequency (MHz)	EMI7403 Insertion Loss (dB)
DDR50/SDR50	50	100 (m1)	m1 = 3.27

MECHANICAL CASE OUTLINE

PACKAGE DIMENSIONS

ON Semiconductor®



SCALE 4:1

WLCSP15, 1.56x1.56
CASE 567FX
ISSUE O

DATE 07 JUN 2012

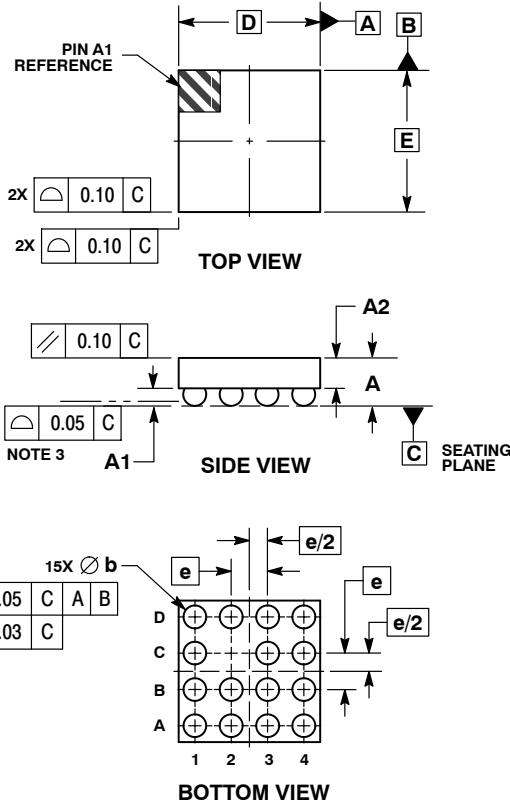

- NOTES:
1. DIMENSIONING AND TOLERANCING PER ASME Y14.5M, 1994.
 2. CONTROLLING DIMENSION: MILLIMETERS.
 3. COPLANARITY APPLIES TO SPHERICAL CROWNS OF SOLDER BALLS.

DIM	MILLIMETERS	
	MIN	MAX
A	0.47	0.53
A1	0.185	0.205
A2	0.305 REF	
b	0.24	0.29
D	1.56 BSC	
E	1.56 BSC	
e	0.40 BSC	

GENERIC MARKING DIAGRAM*

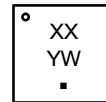

- XX = Specific Device Code
- Y = Year
- W = Work Week
- = Pb-Free Package

*This information is generic. Please refer to device data sheet for actual part marking. Pb-Free indicator, "G" or microdot "■", may or may not be present.

RECOMMENDED SOLDERING FOOTPRINT*

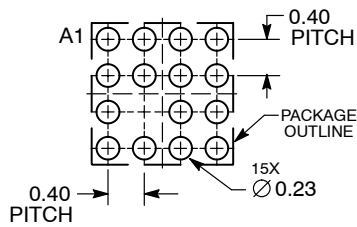

DIMENSIONS: MILLIMETERS

*For additional information on our Pb-Free strategy and soldering details, please download the ON Semiconductor Soldering and Mounting Techniques Reference Manual, SOLDERRM/D.

DOCUMENT NUMBER:	98AON81359E	Electronic versions are uncontrolled except when accessed directly from the Document Repository. Printed versions are uncontrolled except when stamped "CONTROLLED COPY" in red.
DESCRIPTION:	WLCSP15, 1.56X1.56	PAGE 1 OF 1

ON Semiconductor and are trademarks of Semiconductor Components Industries, LLC dba ON Semiconductor or its subsidiaries in the United States and/or other countries. ON Semiconductor reserves the right to make changes without further notice to any products herein. ON Semiconductor makes no warranty, representation or guarantee regarding the suitability of its products for any particular purpose, nor does ON Semiconductor assume any liability arising out of the application or use of any product or circuit, and specifically disclaims any and all liability, including without limitation special, consequential or incidental damages. ON Semiconductor does not convey any license under its patent rights nor the rights of others.

onsemi, **Onsemi**, and other names, marks, and brands are registered and/or common law trademarks of Semiconductor Components Industries, LLC dba "**onsemi**" or its affiliates and/or subsidiaries in the United States and/or other countries. **onsemi** owns the rights to a number of patents, trademarks, copyrights, trade secrets, and other intellectual property. A listing of **onsemi**'s product/patent coverage may be accessed at www.onsemi.com/site/pdf/Patent-Marking.pdf. **onsemi** reserves the right to make changes at any time to any products or information herein, without notice. The information herein is provided "as-is" and **onsemi** makes no warranty, representation or guarantee regarding the accuracy of the information, product features, availability, functionality, or suitability of its products for any particular purpose, nor does **onsemi** assume any liability arising out of the application or use of any product or circuit, and specifically disclaims any and all liability, including without limitation special, consequential or incidental damages. Buyer is responsible for its products and applications using **onsemi** products, including compliance with all laws, regulations and safety requirements or standards, regardless of any support or applications information provided by **onsemi**. "Typical" parameters which may be provided in **onsemi** data sheets and/or specifications can and do vary in different applications and actual performance may vary over time. All operating parameters, including "Typicals" must be validated for each customer application by customer's technical experts. **onsemi** does not convey any license under any of its intellectual property rights nor the rights of others. **onsemi** products are not designed, intended, or authorized for use as a critical component in life support systems or any FDA Class 3 medical devices or medical devices with a same or similar classification in a foreign jurisdiction or any devices intended for implantation in the human body. Should Buyer purchase or use **onsemi** products for any such unintended or unauthorized application, Buyer shall indemnify and hold **onsemi** and its officers, employees, subsidiaries, affiliates, and distributors harmless against all claims, costs, damages, and expenses, and reasonable attorney fees arising out of, directly or indirectly, any claim of personal injury or death associated with such unintended or unauthorized use, even if such claim alleges that **onsemi** was negligent regarding the design or manufacture of the part. **onsemi** is an Equal Opportunity/Affirmative Action Employer. This literature is subject to all applicable copyright laws and is not for resale in any manner.

PUBLICATION ORDERING INFORMATION

LITERATURE FULFILLMENT:

Email Requests to: orderlit@onsemi.com

onsemi Website: www.onsemi.com

TECHNICAL SUPPORT

North American Technical Support:

Voice Mail: 1 800-282-9855 Toll Free USA/Canada

Phone: 011 421 33 790 2910

Europe, Middle East and Africa Technical Support:

Phone: 00421 33 790 2910

For additional information, please contact your local Sales Representative