

**NOTES:**

1. Material : Music Wire
2. Finish : Zinc - Z
3. Sugg. Max. Deflection : 1891.000 Deg
4. Sugg. Max. Torque : 0.150 (in-lbs)
5. Total Coils : 8.500
6. Sugg. Mandrel Diameter : 0.150 (in)
7. All Drawing Dimensions are in Inches [mm]

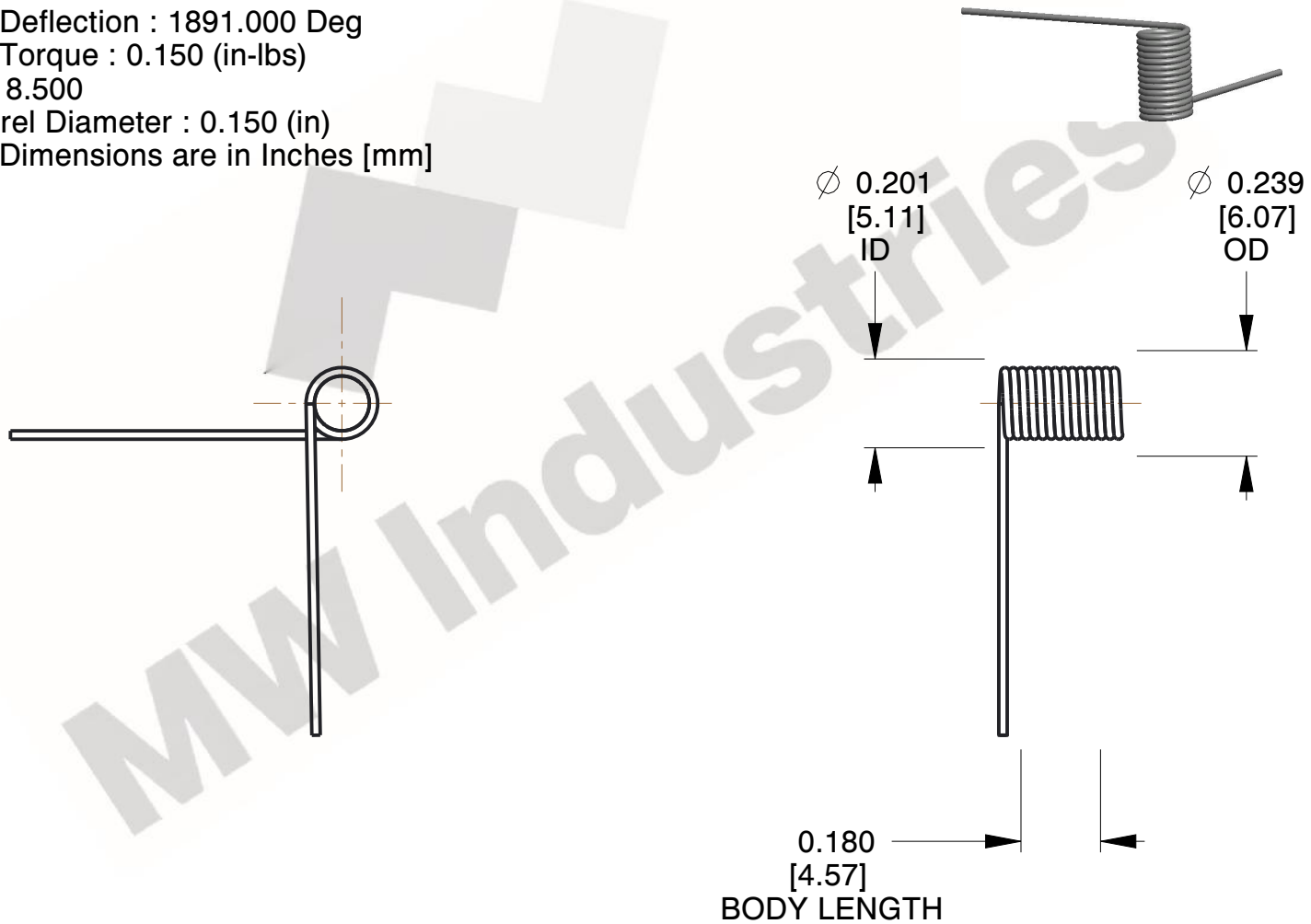

COMPONENT		TORSION SPRINGS	
<b>TO-1114</b>		<b>UNIT</b>	
		INCH [mm]	
TORSION SPRINGS		<b>SHEET</b>	
		1 of 1	