

AN-2021 LM3753/54 Evaluation Board

User's Guide



Literature Number: SNVA420
December 2009

1	Introduction	5
2	Powering and Loading Considerations	5
2.1	QUICK SETUP PROCEDURE	5
3	Board Configuration	6
3.1	LM3753 TRACK	6
3.2	LM3754 SOFT-START	6
3.3	OUTPUT VOLTAGE RIPPLE	6
3.4	EXTERNAL CLOCK SYNCHRONIZATION	7
3.5	POWER GOOD	7
3.6	MARGIN	7
3.7	DCR and RESISTOR SENSE	7
3.8	LOAD PULSE GENERATOR	7
3.9	OVER TEMPERATURE PROTECTION	8
3.10	VCC1, VCC2 and VDD	8
3.11	ACTIVE LOADS	8
4	Typical Performance Characteristics	8
5	Evaluation Board Schematic	10
6	PCB Layout	18

List of Figures

1	Basic Test Setup for the LM3753/54 Evaluation Board.....	6
2	Output Voltage Ripple Measurement Setup.....	7
3	Evaluation Board Schematic — Master.....	10
4	Evaluation Board Schematic — Slave.....	11
5	Evaluation Board Schematic — Interface.....	11
6	Top Layer Components and Overlay.....	18
7	Top Layer Copper.....	19
8	Mid Layer 1 Copper.....	20
9	Mid Layer 2 Copper.....	21
10	Bottom Layer Copper as Viewed From Top.....	22
11	Bottom Layer Components and Overlay as Viewed From Top.....	23

List of Tables

1	Bill of Materials for LM3753 Evaluation Board.....	12
2	Bill of Materials for LM3754 Evaluation Board.....	15

AN-2021 LM3753/54 Evaluation Board

The LM3753/54 evaluation board is designed to provide the design engineer with a fully functional power converter based solution using two LM3753 or LM3754 2-Phase Buck Controllers. This evaluation board produces an output voltage of 1.2 V at 25A per phase for a total of 100A. The switching frequency for the converter is set to 300 kHz per phase, for an effective 1.2 MHz at the input and output. The gate signals for each controller's outputs are 180 degree out of phase, with the two controllers having a 90 degree phase shift from each other. The printed circuit board consists of 4 layers of FR4 material with 2 ounce copper on all layers. This application note contains the evaluation board schematics, Bill-of-Materials (BOM) and a quick setup procedure. Refer to the LM3753/54 datasheet for complete circuit design information.

1 Introduction

The LM3753/54 evaluation board is designed to provide the design engineer with a fully functional power converter based solution using two LM3753 or LM3754 2-Phase Buck Controllers. This evaluation board produces an output voltage of 1.2 V at 25A per phase for a total of 100A. The switching frequency for the converter is set to 300 kHz per phase, for an effective 1.2 MHz at the input and output. The gate signals for each controller's outputs are 180 degree out of phase, with the two controllers having a 90 degree phase shift from each other. The printed circuit board consists of 4 layers of FR4 material with 2 ounce copper on all layers. This application note contains the evaluation board schematics, Bill-of-Materials (BOM) and a quick setup procedure. Refer to the LM3753/54 datasheet for complete circuit design information.

The performance of the evaluation board is as follows:

Input Range	: 6V to 18V
Output Voltage	1.2V \pm 1%
Output Current	0A to 100A
Switching Frequency	300 kHz
Load Regulation	0.1%
Board Size	4.2 x 5.4 x 0.063 inches

2 Powering and Loading Considerations

Read this entire page prior to attempting to power the evaluation board.

2.1 QUICK SETUP PROCEDURE

Step 1: Use an input power supply with at least 30A current capability. Connect the positive output of the power supply to the VIN terminal T1. Connect the negative output of the power supply to the input GND terminal T2.

Step 2: Connect a load with 100A capability to the VOUT terminal T3 and GND terminal T4.

Step 3: (LM3753 only) Connect a secondary power supply to the TRACK terminal TP13 and GND terminal TP2. Set the power supply voltage to 3.3V. Since the LM3753 is configured such that VOUT follows the TRACK input, VOUT cannot come up without applying a voltage to TRACK.

Step 4: Ensure that the Load Pulse switch SW1 is in the center OFF position. Check that the current limit trimmers R18 and R26 are turned fully clockwise for maximum output current. J1, J3, J5 and J7 should be installed, with J2, J4, J6 and J8 open.

Step 5: Set VIN to 12 V with no load being applied. Turn on the input power supply (followed by the secondary power supply for the LM3753 TRACK). The output voltage should be in regulation with a nominal value of 1.2V.

Step 6: Slowly increase the load while monitoring the output voltage. The output voltage should remain in regulation up to the full load current of 100A.

Step 7: Slowly vary the input voltage from 6V to 18V. The output voltage should remain in regulation with a nominal value of 1.2V.

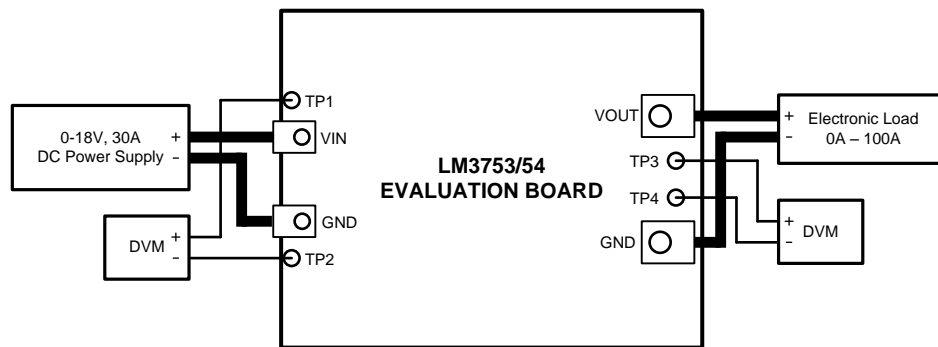

Figure 1. Basic Test Setup for the LM3753/54 Evaluation Board

3 Board Configuration

3.1 LM3753 TRACK

The LM3753 evaluation board is configured such that VOUT follows the TRACK input. This configuration will not allow VOUT to come up without applying a voltage to TRACK. In order to produce 1.2V on the output, the TRACK pin must be connected to a secondary 3.3V power supply.

To prevent current limit during startup, the rise time of the 3.3V TRACK signal should be longer than 100 μ s.

3.2 LM3754 SOFT-START

The LM3754 evaluation board is configured such that VOUT follows the SS signal, which is set by C12 and an internal 10 μ A current source. This allows the LM3754 to operate on its own, with a single power supply connected to VIN.

3.3 OUTPUT VOLTAGE RIPPLE

Output voltage ripple measurement should be taken directly across the output capacitor C66 between terminals TP3 and TP4. Care must be taken to minimize the loop area between the scope probe tip and the ground lead in order to minimize noise in the measurement. This can be achieved by removing the probe's spring tip and ground lead and then wrap a bare wire around the scope probe shaft. The bare wire should be in contact with the probe shaft since this is the ground lead for the probe. The measurement can be taken by connecting the bare wire onto the ground side of the capacitor and the probe tip onto the positive side of the capacitor. Figure 2 shows a diagram of this measurement technique.

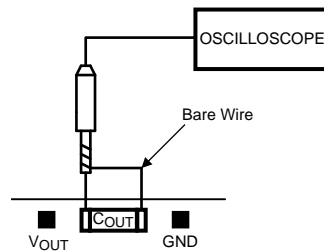

Figure 2. Output Voltage Ripple Measurement Setup

3.4 EXTERNAL CLOCK SYNCHRONIZATION

A SYNCIN terminal has been provided on the evaluation board in order to synchronize the converter to an external clock or other fixed frequency signal from 225 kHz to 375 kHz. Refer to the LM3753/54 datasheet for complete information.

3.5 POWER GOOD

A PGOOD terminal provides monitoring of the Power Good signal. When PGOOD is high at VCC1, the output voltage is within the Power Good window.

3.6 MARGIN

A MARGIN terminal has been provided on the evaluation board in order to adjust the output voltage by $\pm 5\%$. Shorting the MARGIN terminal to GND will adjust the output up 5%. Shorting the MARGIN terminal to VOUT will adjust the output down 5%.

3.7 DCR and RESISTOR SENSE

The LM3753/54 is delivered with the resistor sense option selected. To configure the board for DCR (Inductor DC Resistance) sensing, remove J1, J3, J5 and J7. Turn the current limit trimmers R18 and R26 fully counter-clockwise for the lower DC resistance. Short the power connections J2, J4, J6 and J8. Holes for the power jumpers will accommodate #14 AWG or 2 x #18 AWG solid copper wires. #2-56 hardware may also be used for the power connections. Due to the tight spacing, stagger the screws and nuts on the top and bottom; wrap #18 AWG solid copper wire around the hardware on the top side and tighten. Take care to avoid damaging adjacent components, particularly Q14-Q17 on the bottom side. Brass jumpers such as those used on terminal blocks should be avoided since the resistance is four times that of copper.

3.8 LOAD PULSE GENERATOR

An on-board load pulse generator allows for easy evaluation of the output voltage transient response. The LPI (Load Pulse In) and LPO (Load Pulse Out) terminals provide the interface to the load pulse generator. Setting SW1 to EXT connects LPI to LPO, which then allows the load pulse generator to be driven by LPI with an external 5V logic signal. Setting SW1 to INT allows the load pulse generator to be driven with an internally generated 1 ms pulse at 5% duty cycle.

J9 selects the amount of load. With J9 open, Load Branch 1 is engaged to draw $1.2V / 0.05\Omega = 24A$. With J9 shorted, Load Branch 1 and Load Branch 2 are engaged to draw $1.2V / 0.025\Omega = 48A$. TP41 through TP44 provide monitoring of the load step.

R59, C61 and the gate impedance of Q14-Q17 set the slew rate. With J9 open, $R59 = 51\Omega$ and $C61 = 0.01\ \mu\text{F}$, the slew rate is $24\text{A} / 1\ \mu\text{s}$. With J9 open, $R59 = 51\Omega$ and C61 open, the slew rate is $24\text{A} / 200\ \text{ns}$. Results are shown in the [Section 4](#).

3.9 OVER TEMPERATURE PROTECTION

An LM26LV provides over temperature protection should the PC board exceed 105°C . This shuts down switching by pulling the /FAULT bus low. Normal operation resumes when the board cools below 100°C . A VTEMP terminal provides an analog voltage which is inversely proportional to temperature. Refer to the LM26LV datasheet for complete design information.

3.10 VCC1, VCC2 and VDD

The VCC and VDD terminals provide monitoring points for the on-board voltages. For the evaluation board, VDD is generated by an NPN linear regulator controlled by the LM3753/54. To demonstrate the maximum power stage efficiency, a 5V current limited external supply may be used for VDD. **Extreme care must be exercised when applying an external voltage to the VDD terminal. Under no circumstances should a voltage be applied to VDD while $V_{IN} < 5\text{V}$, as damage to the LM3753/54 will occur.** To protect U1 and U2, the circuit may be modified by placing small Schottky diodes in series with R2 and R16 to block the reverse voltage. Refer to the LM3753/54 datasheet for complete circuit design information.

3.11 ACTIVE LOADS

Many constant-current types of active loads can exhibit an initial short circuit, which is sustained well beyond the normal soft-start cycle. To avoid current limit during startup, wait until the output voltage is up before turning on the load. Using an active load with a constant-resistance mode will avoid this startup timing issue.

4 Typical Performance Characteristics

Efficiency with 5V External VDD and DCR Sense

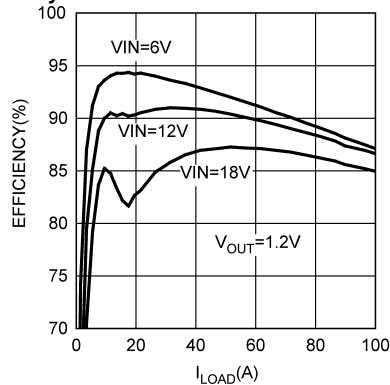

Efficiency with VDD Linear Regulator and Resistor Sense

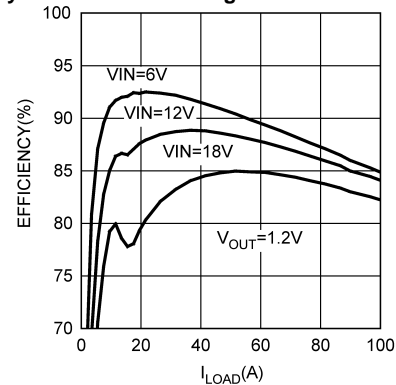

Output Load Transient +24A / 1 μs

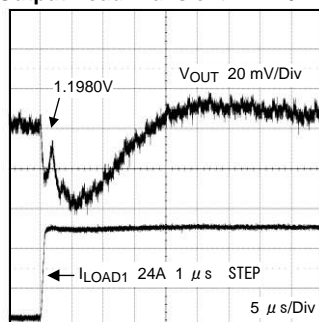

Output Load Transient -24A / 1 μs

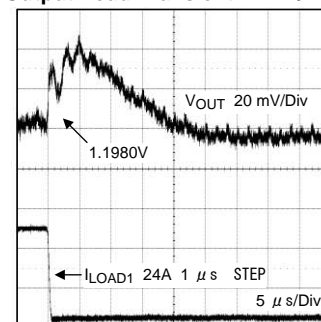

Output Load Transient +24A / 200 ns

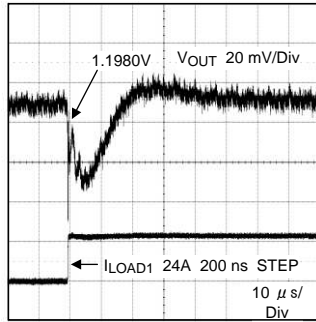

Output Load Transient -24A / 200 ns

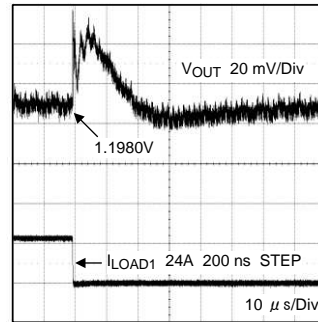

Startup from Enable

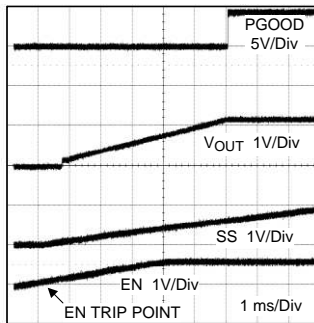

Restart from Fault

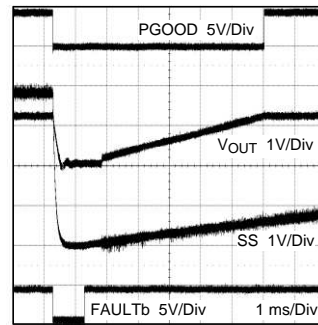

Switching at 12V Input

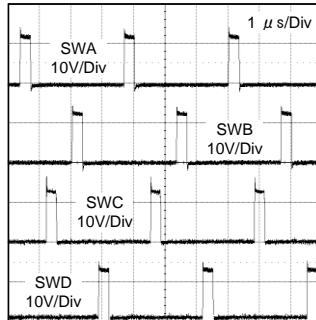

Output Voltage Ripple

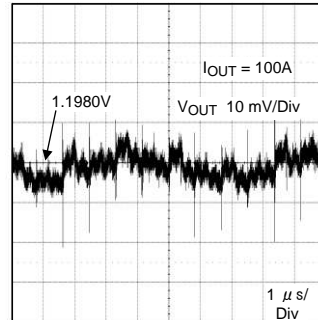

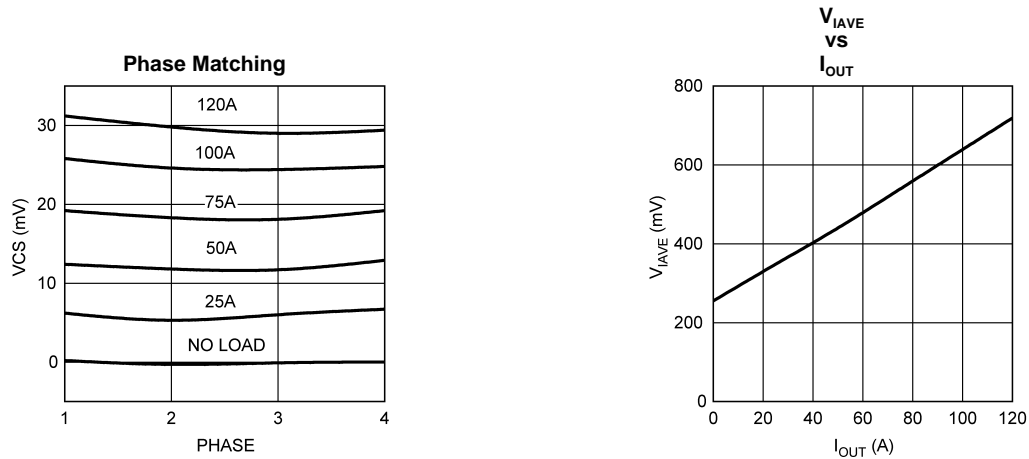

5 Evaluation Board Schematic

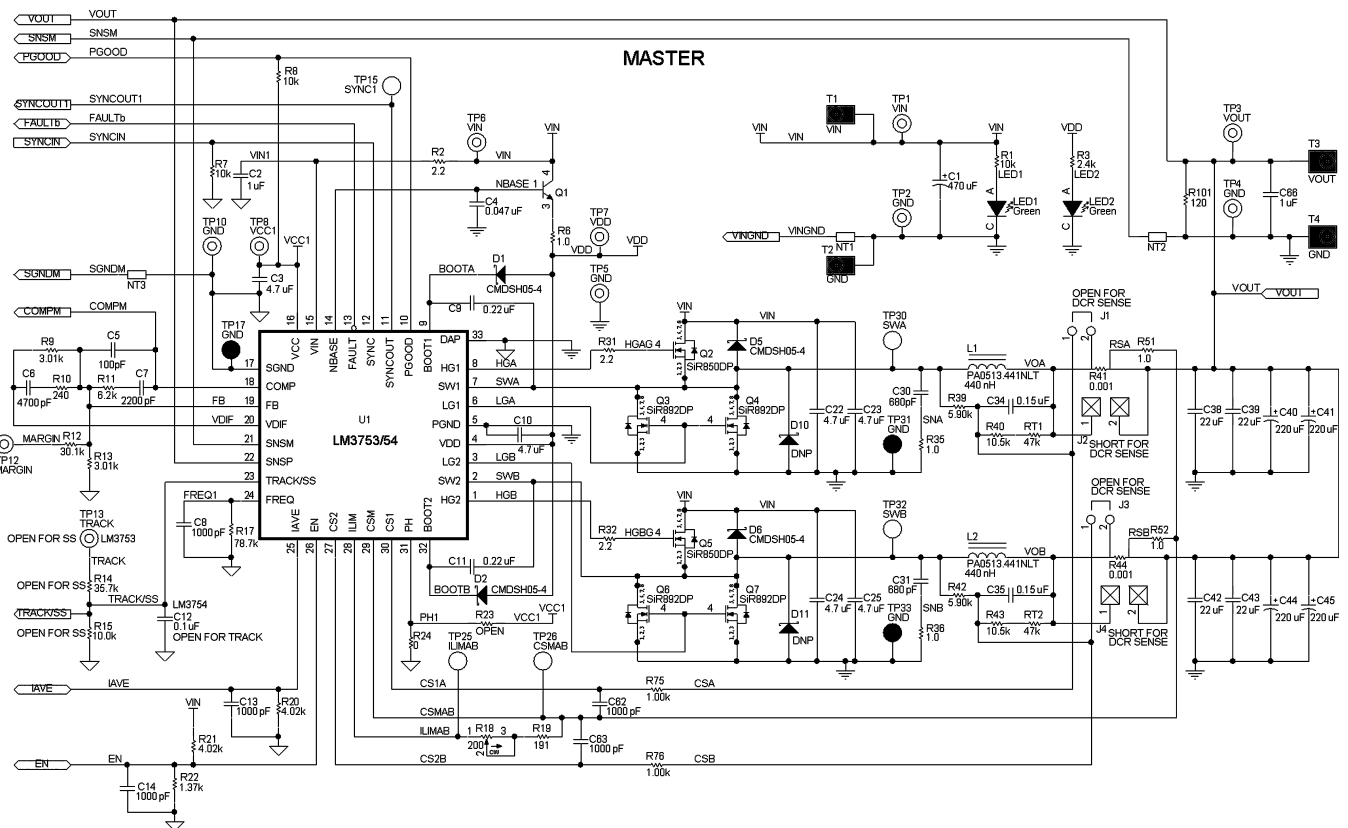

NT1, NT2 and NT3 are net ties for GND sensing.

Figure 3. Evaluation Board Schematic — Master

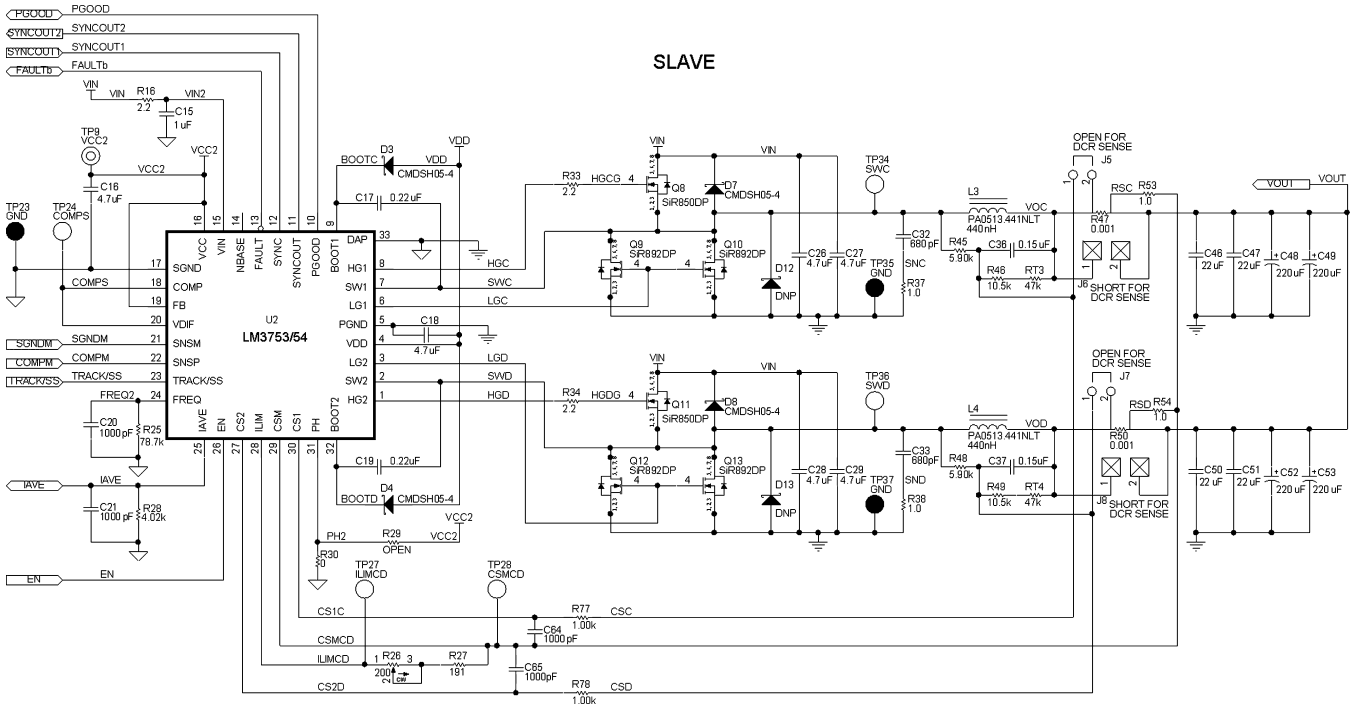

Figure 4. Evaluation Board Schematic — Slave

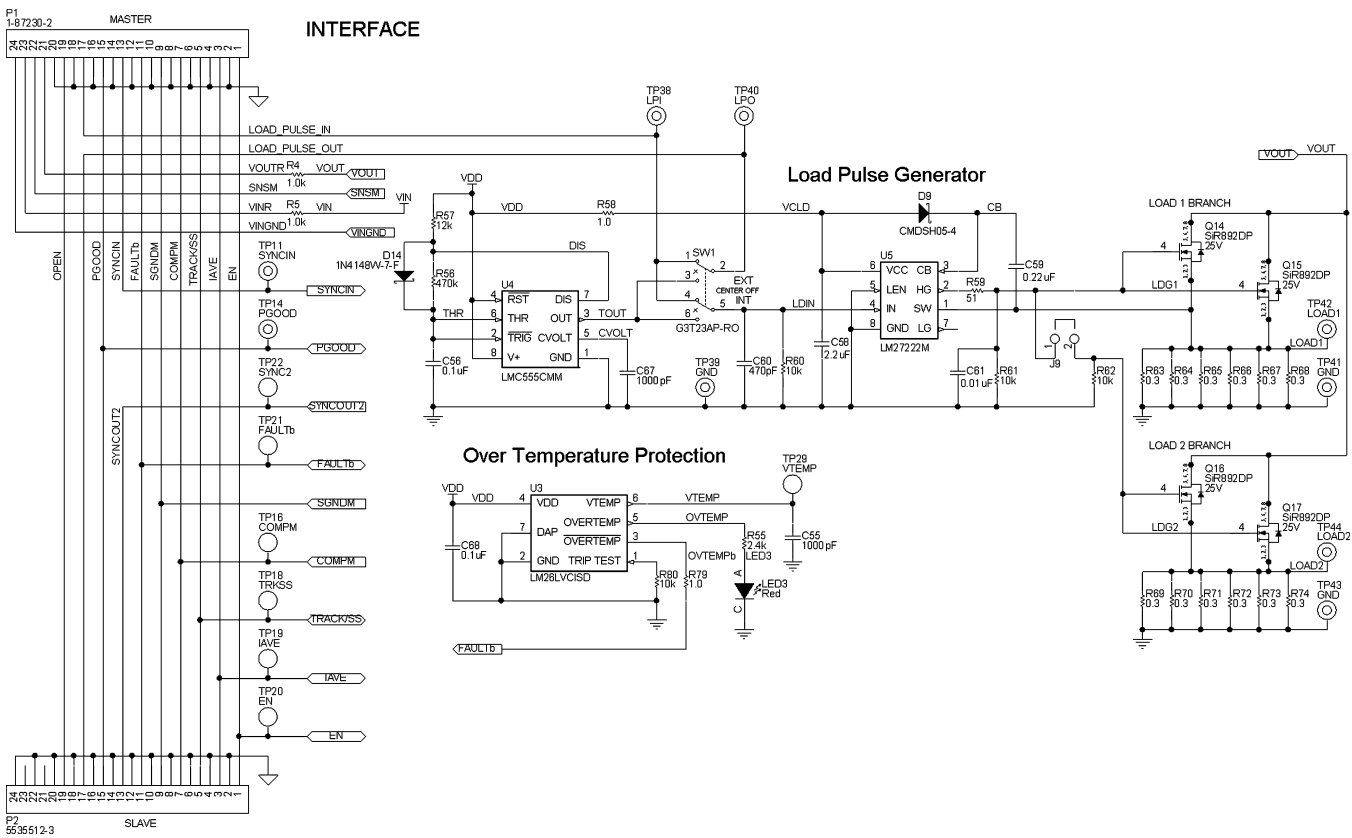

Figure 5. Evaluation Board Schematic — Interface

Table 1. Bill of Materials for LM3753 Evaluation Board

Designator	Value	Package	Description	Manufacturer	Part Number	QTY
C1	470uF	SMT Radial G	AL, 25V, 20%, 0.06 Ohm ESR	Panasonic	EEE-FP1E471AP	1
C2, C15	1uF	0603	Ceramic, X7R, 16V, 10%	TDK	C1608X7R1C105K	2
C3, C10, C16, C18	4.7uF	0805	Ceramic, X7R, 16V, 10%	MuRata	GRM21BR71C475KA73L	4
C4	0.047uF	0603	Ceramic, X7R, 25V, 10%	TDK	C1608X7R1E473K	1
C5	100pF	0603	Ceramic, C0G/NP0, 50V, 5%	TDK	C1608C0G1H101J	1
C6	4700pF	0603	Ceramic, X7R, 50V, 10%	MuRata	GRM188R71H472KA01D	1
C7	2200pF	0603	Ceramic, X7R, 50V, 10%	MuRata	GRM188R71H222KA01D	1
C8, C13, C14, C20, C21, C55, C62, C63, C64, C65, C67	1000pF	0603	Ceramic, X7R, 50V, 10%	MuRata	GRM188R71H102KA01D	11
C9, C11, C17, C19, C59	0.22uF	0603	Ceramic, X7R, 25V, 10%	Taiyo Yuden	TMK107B7224KA-T	5
C22, C23, C24, C25, C26, C27, C28, C29	4.7uF	1210	Ceramic, X7R, 25V, 10%	Taiyo Yuden	TMK325B7475KN-T	8
C30, C31, C32, C33	680pF	0603	Ceramic, C0G/NP0, 50V, 5%	TDK	C1608C0G1H681J	4
C34, C35, C36, C37	0.15uF	0603	Ceramic, X7R, 25V, 10%	MuRata	GRM188R71E154KA01D	4
C38, C39, C42, C43, C46, C47, C50, C51	22uF	1210	Ceramic, X7R, 16V, 10%	MuRata	GRM32ER71C226KE18L	8
C40, C41, C44, C45, C48, C49, C52, C53	220uF	UE	SP, 4V, 20%, 0.005 Ohm ESR	Panasonic	EEF-SE0G221R	8
C56, C68	0.1uF	0603	Ceramic, X7R, 25V, 10%	MuRata	GRM188R71E104KA01D	2
C58	2.2uF	0805	Ceramic, X7R, 16V, 10%	TDK	C2012X7R1C225K	1
C60	470pF	0603	Ceramic, X7R, 50V, 10%	MuRata	GRM188R71H471KA01D	1
C61	0.01uF	0603	Ceramic, X7R, 50V, 10%	TDK	C1608X7R1H103K	1
C66	1uF	1206	Ceramic, X7R, 25V, 10%	AVX	12063C105KAT2A	1
D1, D2, D3, D4, D5, D6, D7, D8, D9	0.47V	SOD-323	Vr = 40V, Io = 0.5A, Vf = 0.47V	Central Semiconductor	CMDSH05-4	9
D14	1.25V	SOD-123	Vr = 100V, Io = 0.15A, Vf = 1.25V	Diodes Inc.	1N4148W-7-F	1
H1, H2			Mach Screw, Round, #10-32 x 3/8, Brass		2EA13	2
H3, H4			Mach Screw, Round, #1/4-20 x 1/2, Brass		2EA30	2
H5, H6			Lock Nut, #10-32, Stainless Steel		1EY35	2
H7, H8			Lock Nut, #1/4-20, Brass		1FA58	2
H9, H10, H11, H12			Machine Screw, Round, #4-40 x 1/4, Nylon		4DFG1	4
H13, H14, H15, H16			Standoff Hex 0.5"L #4-40 Nylon	Keystone	1902C	4

Table 1. Bill of Materials for LM3753 Evaluation Board (continued)

Designator	Value	Package	Description	Manufacturer	Part Number	QTY
J1, J3, J5, J7, J9	1x2		Header, TH, 100mil, 1x2, Tin plated	Samtec Inc.	TSW-102-07-T-S	5
L1, L2, L3, L4	440nH	PA1513	Power Beads, 440nH, 0.32 mOhm	Pulse Engineering	PA0513.441NLT	4
LED1, LED2	Green	Power TOPLED w/lens	0.114W, 3.8V	OSRAM	LT E63C-BACB- 35-L-Z	2
LED3	Red	Power TOPLED w/lens	0.1075W, 2.15V	OSRAM	LS E63F-DBFA-1- Z	1
P1			Header, 24-Pin, Right Angle	Tyco Electronics	1-87230-2	1
P2			Receptacle 24-Pin, Right Angle	Tyco Electronics	5535512-3	1
Q1	NPN	DPAK	NPN, 8A, 80V	Central Semiconductor	CJD44H11	1
Q2, Q5, Q8, Q11	25V	PowerPA K SO-8	30A, 8.5nC, 7 mOHM	Vishay-Siliconix	SiR850DP	4
Q3, Q4, Q6, Q7, Q9, Q10, Q12, Q13, Q14, Q15, Q16, Q17	25V	PowerPA K SO-8	50A, 20 nC, 3 mOHM	Vishay-Siliconix	SiR892DP	12
R1, R7, R8, R60, R61, R62, R80	10k	0603	5%, 0.1W	Vishay-Dale	CRCW060310K0J NEA	7
R2, R16, R31, R32, R33, R34	2.2	0603	5%, 0.1W	Vishay-Dale	CRCW06032R20J NEA	6
R3, R55	2.4k	0603	5%, 0.1W	Vishay-Dale	CRCW06032K40J NEA	2
R4, R5	1.0k	0603	5%, 0.1W	Vishay-Dale	CRCW06031K00J NEA	2
R6, R35, R36, R37, R38, R51, R52, R53, R54, R58, R79	1.0	0603	5%, 0.1W	Vishay-Dale	CRCW06031R00J NEA	11
R9, R13	3.01k	0603	0.1%, 0.1W	Yageo America	RT0603BRD073K 01L	2
R10	240	0603	5%, 0.1W	Vishay-Dale	CRCW0603240RJ NEA	1
R11	6.2k	0603	5%, 0.1W	Vishay-Dale	CRCW06036K20J NEA	1
R12	30.1k	0603	1%, 0.1W	Vishay-Dale	CRCW060330K1 FKEA	1
R14	35.7k	0603	1%, 0.1W	Vishay-Dale	CRCW060335K7 FKEA	1
R15	10.0k	0603	1%, 0.1W	Vishay-Dale	CRCW060310K0 FKEA	1
R17, R25	78.7k	0603	1%, 0.1W	Vishay-Dale	CRCW060378K7 FKEA	2
R18, R26	200	TS53Y	Pot 5mm Sq Cermet	Vishay-Sfernice	TS53YL201	2
R19, R27	191	0603	1%, 0.1W	Vishay-Dale	CRCW0603191R FKEA	2
R20, R21, R28	4.02k	0603	1%, 0.1W	Vishay-Dale	CRCW06034K02 FKEA	3
R22	1.37k	0603	1%, 0.1W	Vishay-Dale	CRCW06031K37 FKEA	1
R24, R30	0	0603	5%, 0.1W	Vishay-Dale	CRCW06030000Z 0EA	2
R39, R42, R45, R48	5.90k	0603	1%, 0.1W	Vishay-Dale	CRCW06035K90 FKEA	4

Table 1. Bill of Materials for LM3753 Evaluation Board (continued)

Designator	Value	Package	Description	Manufacturer	Part Number	QTY
R40, R43, R46, R49	10.5k	0603	1%, 0.1W	Vishay-Dale	CRCW060310K5 FKEA	4
R41, R44, R47, R50	0.001	WSK2512	1%, 1W	Vishay-Dale	WSK25121L000F EA	4
R56	470k	0603	5%, 0.1W	Vishay-Dale	CRCW0603470KJ NEA	1
R57	12k	0603	5%, 0.1W	Vishay-Dale	CRCW060312K0J NEA	1
R59	51	0603	5%, 0.1W	Vishay-Dale	CRCW060351R0J NEA	1
R63, R64, R65, R66, R67, R68, R69, R70, R71, R72, R73, R74	0.3	2512	1%, 1W	Panasonic	ERJ-1TRQFR30U	12
R75, R76, R77, R78	1.00k	0603	1%, 0.1W	Vishay-Dale	CRCW06031K00 FKEA	4
R101	120		5%, 0.25W	Panasonic	ERD-S2TJ121V	1
RT1, RT2, RT3, RT4	47k	0603	Thermistor, 47K, 2%, B25/50 4050, 0.1W	MuRata	NCP18WB47J303 RB	4
SH-J1, SH-J3, SH-J5, SH-J7, SH-J9	1x2		Shunt, 100mil, Tin plated, Black	Amp	2-382811-1	5
SW1			Switch, DPDT, 3 Position	NKK	G3T23AP-RO	1
T1, T2	50A		Terminal 50A Lug	Panduit	CB35-36-CY	2
T3, T4	90A		Terminal 90A Lug	Panduit	CB70-14-CY	2
TP1, TP2, TP3, TP4, TP5, TP6, TP7, TP8, TP9, TP10, TP11, TP12, TP13, TP14, TP38, TP39, TP40, TP41, TP42, TP43, TP44	Triple		Terminal, Turret, TH, Triple	Keystone Electronics	1598-2	21
TP15, TP16, TP18, TP19, TP20, TP21, TP22, TP24, TP25, TP26, TP27, TP28, TP29, TP30, TP32, TP34, TP36	White		Test Point, TH, Multipurpose, White	Keystone Electronics	5012	17
TP17, TP23, TP31, TP33, TP35, TP37	Black		Test Point, TH, Multipurpose, Black	Keystone Electronics	5011	6
U1, U2	LM3753	SQA32A	Multi-Phase Buck Controller	National Semiconductor	LM3753SQ	2
U3	LM26LV 105°C	SDB06A	1.6V, LLP-6 Factory Preset Temperature Switch and Temperature Sensor	National Semiconductor	LM26LVCISD-105	1
U4	LMC555	MUA08A	CMOS Timer	National Semiconductor	LMC555CMM	1
U5	LM2722 2	M08A	High-Speed 4.5A Synchronous MOSFET Driver	National Semiconductor	LM27222M	1

Table 2. Bill of Materials for LM3754 Evaluation Board

Designator	Value	Package	Description	Manufacturer	Part Number	QTY
C1	470uF	SMT Radial G	AL, 25V, 20%, 0.06 Ohm ESR	Panasonic	EEE-FP1E471AP	1
C2, C15	1uF	0603	Ceramic, X7R, 16V, 10%	TDK	C1608X7R1C105K	2
C3, C10, C16, C18	4.7uF	0805	Ceramic, X7R, 16V, 10%	MuRata	GRM21BR71C475KA73L	4
C4	0.047uF	0603	Ceramic, X7R, 25V, 10%	TDK	C1608X7R1E473K	1
C5	100pF	0603	Ceramic, C0G/NP0, 50V, 5%	TDK	C1608C0G1H101J	1
C6	4700pF	0603	Ceramic, X7R, 50V, 10%	MuRata	GRM188R71H472KA01D	1
C7	2200pF	0603	Ceramic, X7R, 50V, 10%	MuRata	GRM188R71H222KA01D	1
C8, C13, C14, C20, C21, C55, C62, C63, C64, C65, C67	1000pF	0603	Ceramic, X7R, 50V, 10%	MuRata	GRM188R71H102KA01D	11
C9, C11, C17, C19, C59	0.22uF	0603	Ceramic, X7R, 25V, 10%	Taiyo Yuden	TMK107B7224KA-T	5
C12, C56, C68	0.1uF	0603	Ceramic, X7R, 25V, 10%	MuRata	GRM188R71E104KA01D	3
C22, C23, C24, C25, C26, C27, C28, C29	4.7uF	1210	Ceramic, X7R, 25V, 10%	Taiyo Yuden	TMK325B7475KN-T	8
C30, C31, C32, C33	680pF	0603	Ceramic, C0G/NP0, 50V, 5%	TDK	C1608C0G1H681J	4
C34, C35, C36, C37	0.15uF	0603	Ceramic, X7R, 25V, 10%	MuRata	GRM188R71E154KA01D	4
C38, C39, C42, C43, C46, C47, C50, C51	22uF	1210	Ceramic, X7R, 16V, 10%	MuRata	GRM32ER71C226KE18L	8
C40, C41, C44, C45, C48, C49, C52, C53	220uF	UE	SP, 4V, 20%, 0.005 Ohm ESR	Panasonic	EEF-SE0G221R	8
C58	2.2uF	0805	Ceramic, X7R, 16V, 10%	TDK	C2012X7R1C225K	1
C60	470pF	0603	Ceramic, X7R, 50V, 10%	MuRata	GRM188R71H471KA01D	1
C61	0.01uF	0603	Ceramic, X7R, 50V, 10%	TDK	C1608X7R1H103K	1
C66	1uF	1206	Ceramic, X7R, 25V, 10%	AVX	12063C105KAT2A	1
D1, D2, D3, D4, D5, D6, D7, D8, D9	0.47V	SOD-323	Vr = 40V, Io = 0.5A, Vf = 0.47V	Central Semiconductor	CMDSH05-4	9
D14	1.25V	SOD-123	Vr = 100V, Io = 0.15A, Vf = 1.25V	Diodes Inc.	1N4148W-7-F	1
H1, H2			Mach Screw, Round, #10-32 x 3/8, Brass		2EA13	2
H3, H4			Mach Screw, Round, #1/4-20 x 1/2, Brass		2EA30	2
H5, H6			Lock Nut, #10-32, Stainless Steel		1EY35	2
H7, H8			Lock Nut, #1/4-20, Brass		1FA58	2
H9, H10, H11, H12			Machine Screw, Round, #4-40 x 1/4, Nylon		4DFG1	4
H13, H14, H15, H16			Standoff Hex 0.5"L #4-40 Nylon	Keystone	1902C	4

Table 2. Bill of Materials for LM3754 Evaluation Board (continued)

Designator	Value	Package	Description	Manufacturer	Part Number	QTY
J1, J3, J5, J7, J9	1x2		Header, TH, 100mil, 1x2, Tin plated	Samtec Inc.	TSW-102-07-T-S	5
L1, L2, L3, L4	440nH	PA1513	Power Beads, 440nH, 0.32 mOhm	Pulse Engineering	PA0513.441NLT	4
LED1, LED2	Green	Power TOPLED w/lens	0.114W, 3.8V	OSRAM	LT E63C-BACB- 35-L-Z	2
LED3	Red	Power TOPLED w/lens	0.1075W, 2.15V	OSRAM	LS E63F-DBFA-1- Z	1
P1			Header, 24-Pin, Right Angle	Tyco Electronics	1-87230-2	1
P2			Receptacle 24-Pin, Right Angle	Tyco Electronics	5535512-3	1
Q1	NPN	DPAK	NPN, 8A, 80V	Central Semiconductor	CJD44H11	1
Q2, Q5, Q8, Q11	25V	PowerPA K SO-8	30A, 8.5nC, 7 mOHM	Vishay-Siliconix	SiR850DP	4
Q3, Q4, Q6, Q7, Q9, Q10, Q12, Q13, Q14, Q15, Q16, Q17	25V	PowerPA K SO-8	50A, 20 nC, 3 mOHM	Vishay-Siliconix	SiR892DP	12
R1, R7, R8, R60, R61, R62, R80	10k	0603	5%, 0.1W	Vishay-Dale	CRCW060310K0J NEA	7
R2, R16, R31, R32, R33, R34	2.2	0603	5%, 0.1W	Vishay-Dale	CRCW06032R20J NEA	6
R3, R55	2.4k	0603	5%, 0.1W	Vishay-Dale	CRCW06032K40J NEA	2
R4, R5	1.0k	0603	5%, 0.1W	Vishay-Dale	CRCW06031K00J NEA	2
R6, R35, R36, R37, R38, R51, R52, R53, R54, R58, R79	1.0	0603	5%, 0.1W	Vishay-Dale	CRCW06031R00J NEA	11
R9, R13	3.01k	0603	0.1%, 0.1W	Yageo America	RT0603BRD073K 01L	2
R10	240	0603	5%, 0.1W	Vishay-Dale	CRCW0603240RJ NEA	1
R11	6.2k	0603	5%, 0.1W	Vishay-Dale	CRCW06036K20J NEA	1
R12	30.1k	0603	1%, 0.1W	Vishay-Dale	CRCW060330K1 FKEA	1
R17, R25	78.7k	0603	1%, 0.1W	Vishay-Dale	CRCW060378K7 FKEA	2
R18, R26	200	TS53Y	Pot 5mm Sq Cermet	Vishay-Sfernice	TS53YL201	2
R19, R27	191	0603	1%, 0.1W	Vishay-Dale	CRCW0603191R FKEA	2
R20, R21, R28	4.02k	0603	1%, 0.1W	Vishay-Dale	CRCW06034K02 FKEA	3
R22	1.37k	0603	1%, 0.1W	Vishay-Dale	CRCW06031K37 FKEA	1
R24, R30	0	0603	5%, 0.1W	Vishay-Dale	CRCW06030000Z 0EA	2
R39, R42, R45, R48	5.90k	0603	1%, 0.1W	Vishay-Dale	CRCW06035K90 FKEA	4
R40, R43, R46, R49	10.5k	0603	1%, 0.1W	Vishay-Dale	CRCW060310K5 FKEA	4
R41, R44, R47, R50	0.001	WSK2512	1%, 1W	Vishay-Dale	WSK25121L000F EA	4

Table 2. Bill of Materials for LM3754 Evaluation Board (continued)

Designator	Value	Package	Description	Manufacturer	Part Number	QTY
R56	470k	0603	5%, 0.1W	Vishay-Dale	CRCW0603470KJ NEA	1
R57	12k	0603	5%, 0.1W	Vishay-Dale	CRCW060312K0J NEA	1
R59	51	0603	5%, 0.1W	Vishay-Dale	CRCW060351R0J NEA	1
R63, R64, R65, R66, R67, R68, R69, R70, R71, R72, R73, R74	0.3	2512	1%, 1W	Panasonic	ERJ-1TRQFR30U	12
R75, R76, R77, R78	1.00k	0603	1%, 0.1W	Vishay-Dale	CRCW06031K00 FKEA	4
R101	120		5%, 0.25W	Panasonic	ERD-S2TJ121V	1
RT1, RT2, RT3, RT4	47k	0603	Thermistor, 47K, 2%, B25/50 4050, 0.1W	MuRata	NCP18WB473J03 RB	4
SH-J1, SH-J3, SH-J5, SH-J7, SH-J9	1x2		Shunt, 100mil, Tin plated, Black	Amp	2-382811-1	5
SW1			Switch, DPDT, 3 Position	NKK	G3T23AP-RO	1
T1, T2	50A		Terminal 50A Lug	Panduit	CB35-36-CY	2
T3, T4	90A		Terminal 90A Lug	Panduit	CB70-14-CY	2
TP1, TP2, TP3, TP4, TP5, TP6, TP7, TP8, TP9, TP10, TP11, TP12, TP14, TP38, TP39, TP40, TP41, TP42, TP43, TP44	Triple		Terminal, Turret, TH, Triple	Keystone Electronics	1598-2	20
TP15, TP16, TP18, TP19, TP20, TP21, TP22, TP24, TP25, TP26, TP27, TP28, TP29, TP30, TP32, TP34, TP36	White		Test Point, TH, Multipurpose, White	Keystone Electronics	5012	17
TP17, TP23, TP31, TP33, TP35, TP37	Black		Test Point, TH, Multipurpose, Black	Keystone Electronics	5011	6
U1, U2	LM3754	SQA32A	Multi-Phase Buck Controller	National Semiconductor	LM3754SQ	2
U3	LM26LV 105°C	SDB06A	1.6V, LLP-6 Factory Preset Temperature Switch and Temperature Sensor	National Semiconductor	LM26LVCISD-105	1
U4	LMC555	MUA08A	CMOS Timer	National Semiconductor	LMC555CMM	1
U5	LM2722 2	M08A	High-Speed 4.5A Synchronous MOSFET Driver	National Semiconductor	LM27222M	1

6 PCB Layout

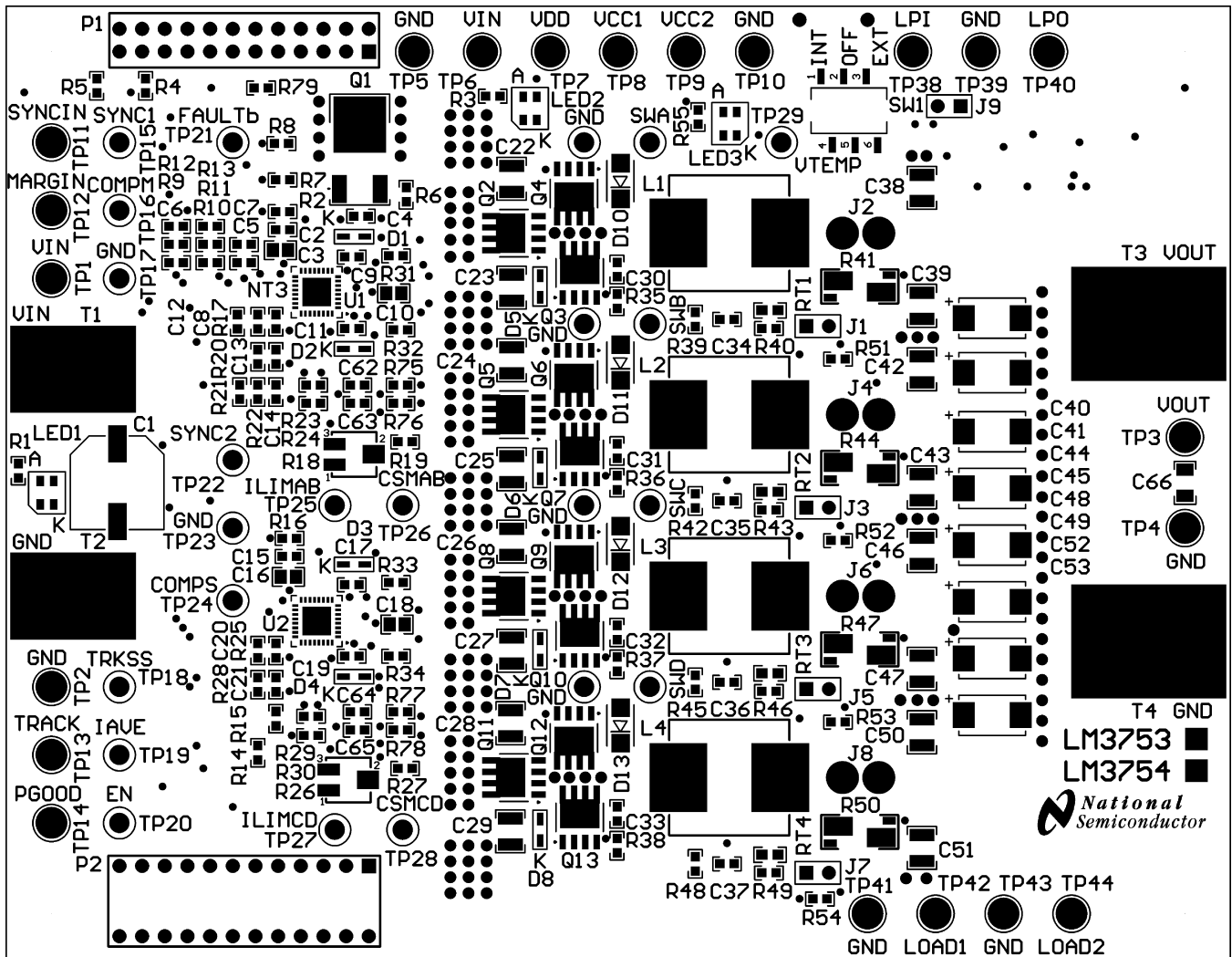

Figure 6. Top Layer Components and Overlay

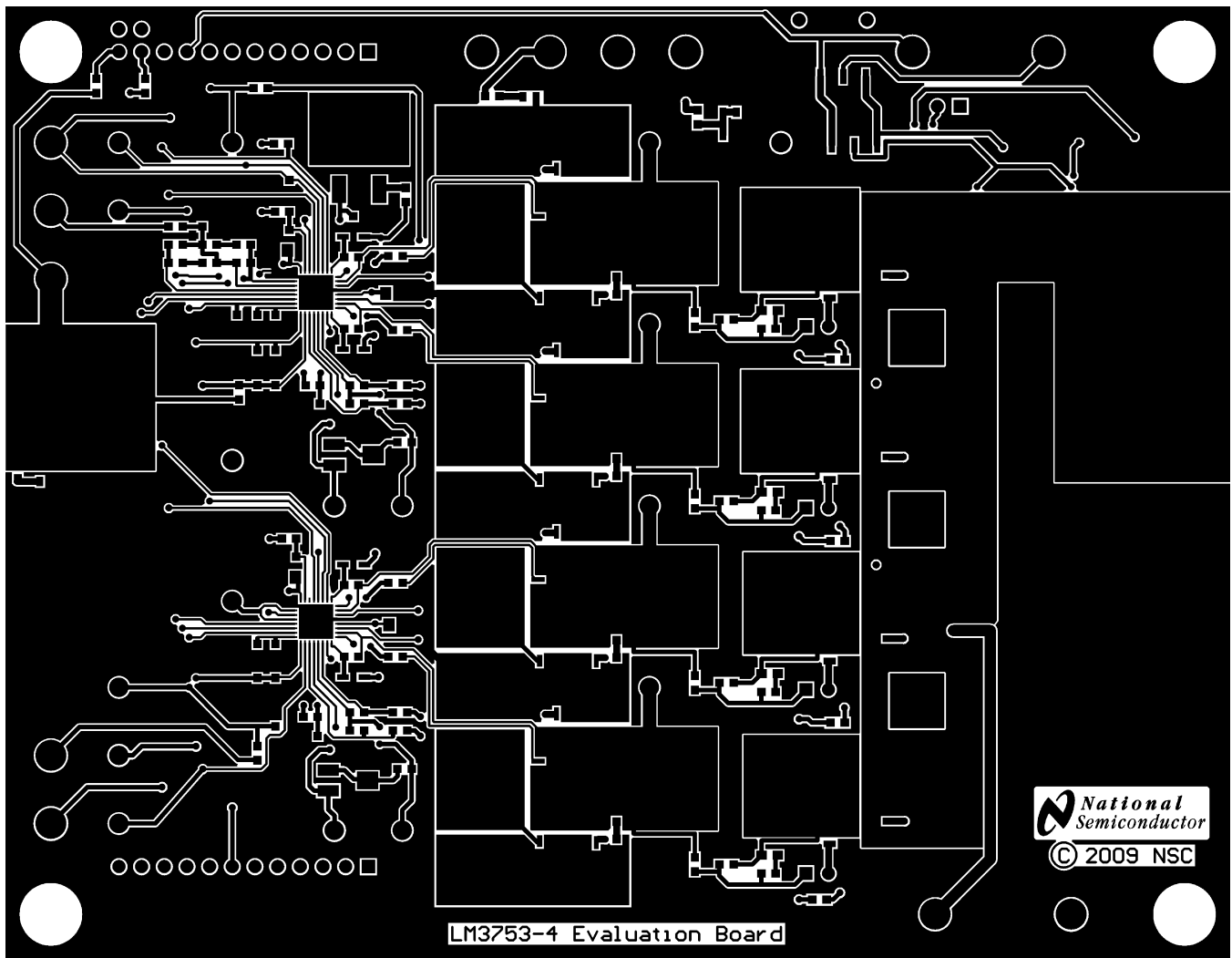

Figure 7. Top Layer Copper

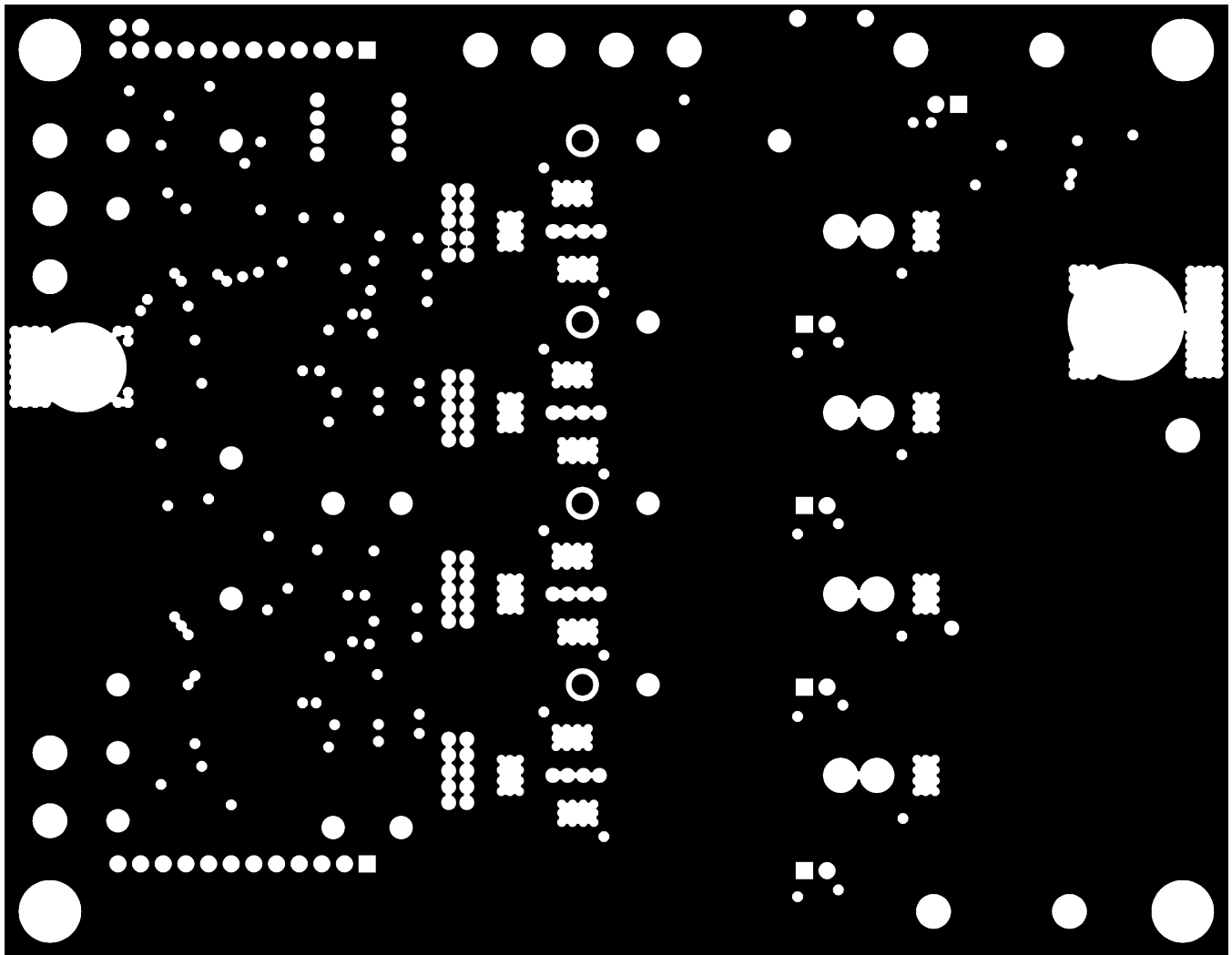

Figure 8. Mid Layer 1 Copper

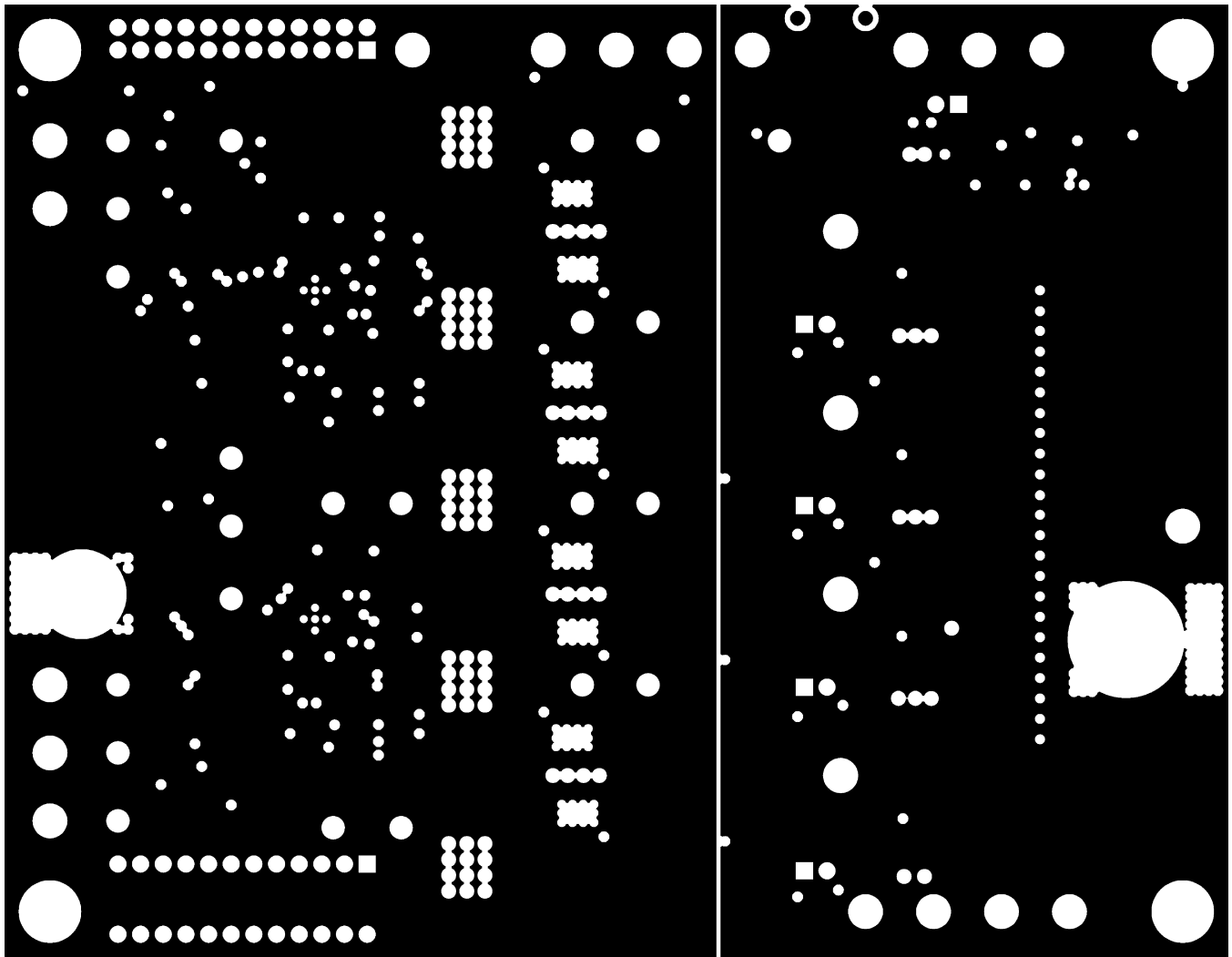

Figure 9. Mid Layer 2 Copper

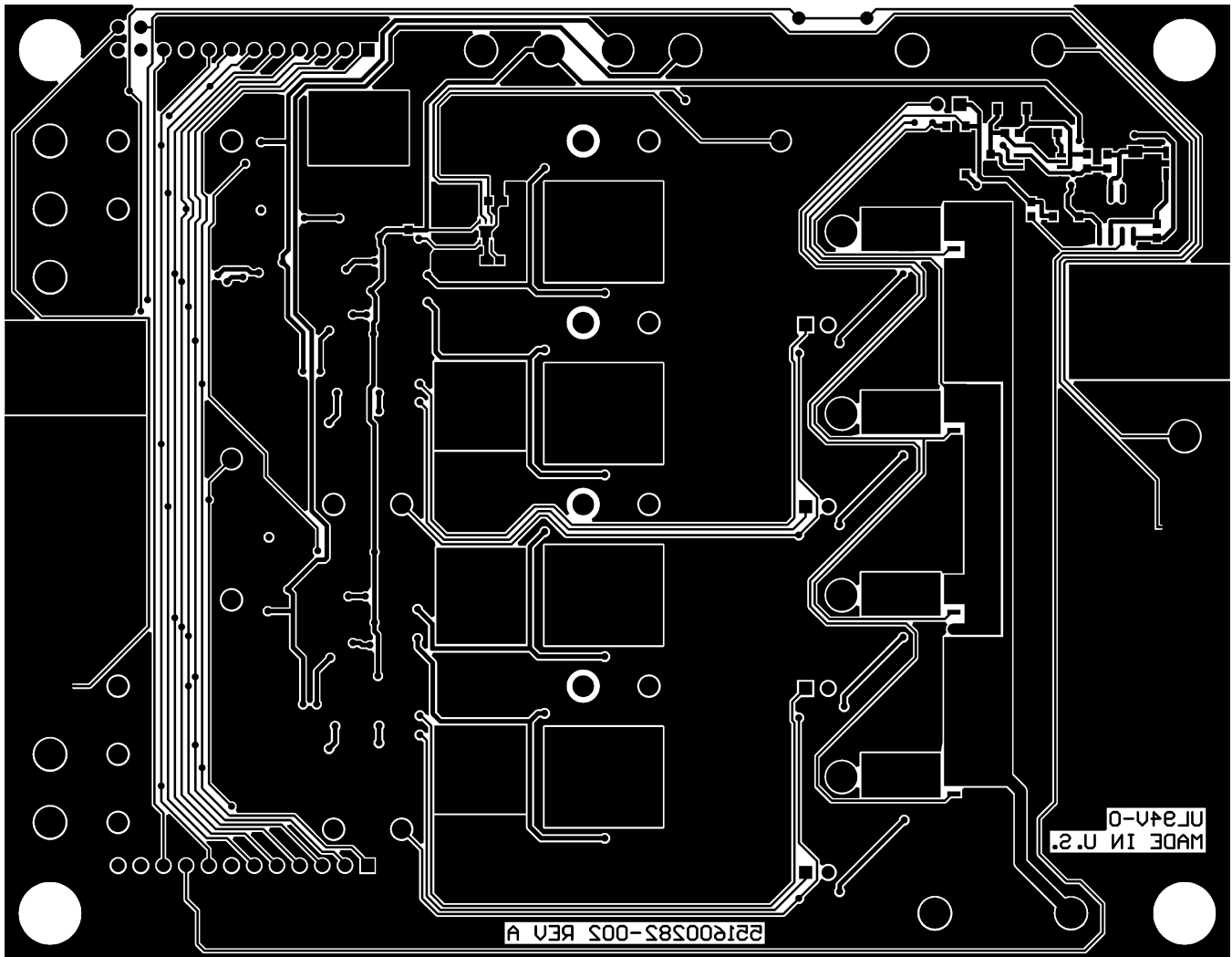

Figure 10. Bottom Layer Copper as Viewed From Top

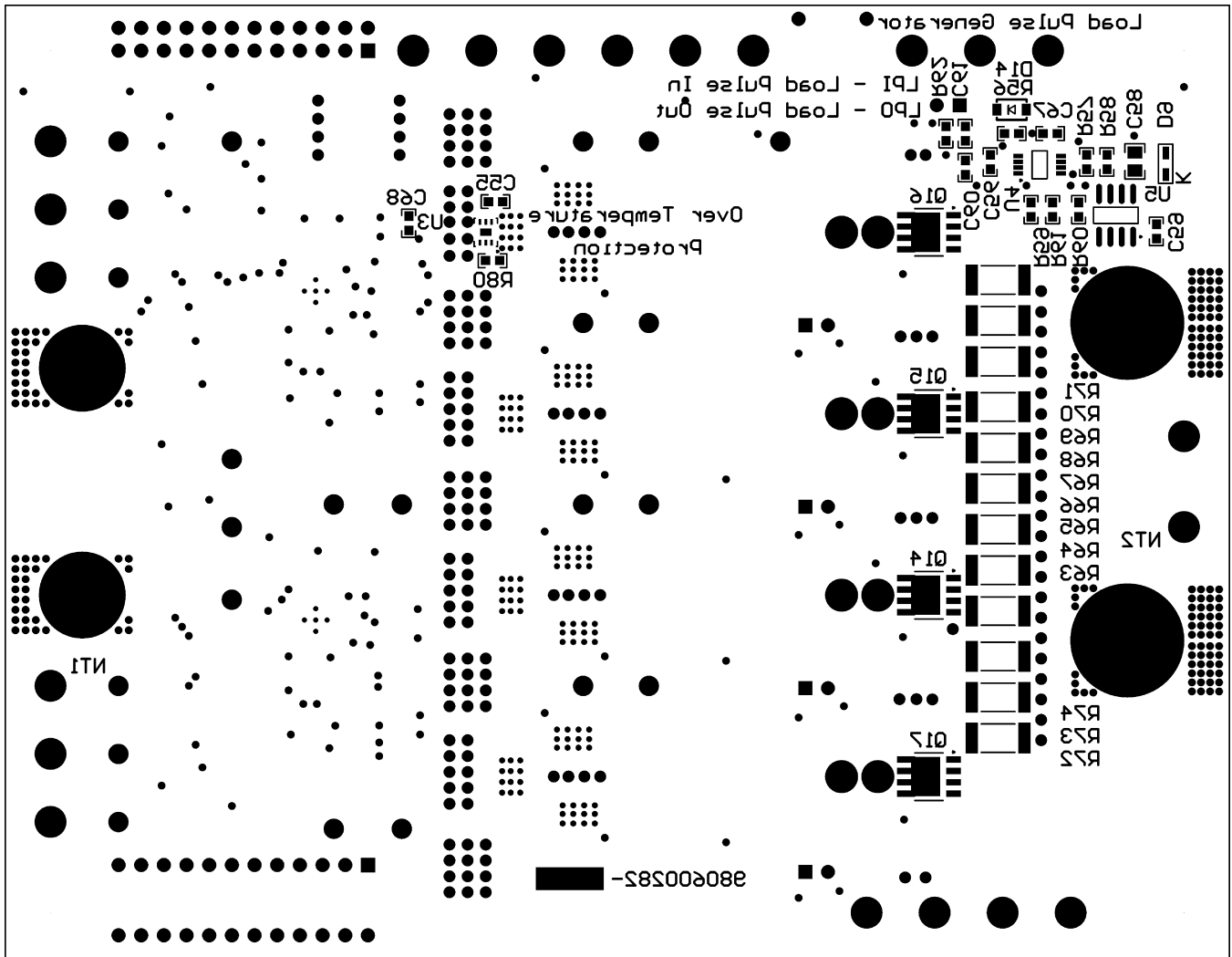

Figure 11. Bottom Layer Components and Overlay as Viewed From Top

STANDARD TERMS AND CONDITIONS FOR EVALUATION MODULES

1. *Delivery:* TI delivers TI evaluation boards, kits, or modules, including any accompanying demonstration software, components, or documentation (collectively, an "EVM" or "EVMs") to the User ("User") in accordance with the terms and conditions set forth herein. Acceptance of the EVM is expressly subject to the following terms and conditions.
 - 1.1 EVMs are intended solely for product or software developers for use in a research and development setting to facilitate feasibility evaluation, experimentation, or scientific analysis of TI semiconductor products. EVMs have no direct function and are not finished products. EVMs shall not be directly or indirectly assembled as a part or subassembly in any finished product. For clarification, any software or software tools provided with the EVM ("Software") shall not be subject to the terms and conditions set forth herein but rather shall be subject to the applicable terms and conditions that accompany such Software
 - 1.2 EVMs are not intended for consumer or household use. EVMs may not be sold, sublicensed, leased, rented, loaned, assigned, or otherwise distributed for commercial purposes by Users, in whole or in part, or used in any finished product or production system.
2. *Limited Warranty and Related Remedies/Disclaimers:*
 - 2.1 These terms and conditions do not apply to Software. The warranty, if any, for Software is covered in the applicable Software License Agreement.
 - 2.2 TI warrants that the TI EVM will conform to TI's published specifications for ninety (90) days after the date TI delivers such EVM to User. Notwithstanding the foregoing, TI shall not be liable for any defects that are caused by neglect, misuse or mistreatment by an entity other than TI, including improper installation or testing, or for any EVMs that have been altered or modified in any way by an entity other than TI. Moreover, TI shall not be liable for any defects that result from User's design, specifications or instructions for such EVMs. Testing and other quality control techniques are used to the extent TI deems necessary or as mandated by government requirements. TI does not test all parameters of each EVM.
 - 2.3 If any EVM fails to conform to the warranty set forth above, TI's sole liability shall be at its option to repair or replace such EVM, or credit User's account for such EVM. TI's liability under this warranty shall be limited to EVMs that are returned during the warranty period to the address designated by TI and that are determined by TI not to conform to such warranty. If TI elects to repair or replace such EVM, TI shall have a reasonable time to repair such EVM or provide replacements. Repaired EVMs shall be warranted for the remainder of the original warranty period. Replaced EVMs shall be warranted for a new full ninety (90) day warranty period.
3. *Regulatory Notices:*
 - 3.1 *United States*
 - 3.1.1 *Notice applicable to EVMs not FCC-Approved:*

This kit is designed to allow product developers to evaluate electronic components, circuitry, or software associated with the kit to determine whether to incorporate such items in a finished product and software developers to write software applications for use with the end product. This kit is not a finished product and when assembled may not be resold or otherwise marketed unless all required FCC equipment authorizations are first obtained. Operation is subject to the condition that this product not cause harmful interference to licensed radio stations and that this product accept harmful interference. Unless the assembled kit is designed to operate under part 15, part 18 or part 95 of this chapter, the operator of the kit must operate under the authority of an FCC license holder or must secure an experimental authorization under part 5 of this chapter.
 - 3.1.2 *For EVMs annotated as FCC – FEDERAL COMMUNICATIONS COMMISSION Part 15 Compliant:*

CAUTION

This device complies with part 15 of the FCC Rules. Operation is subject to the following two conditions: (1) This device may not cause harmful interference, and (2) this device must accept any interference received, including interference that may cause undesired operation.

Changes or modifications not expressly approved by the party responsible for compliance could void the user's authority to operate the equipment.

FCC Interference Statement for Class A EVM devices

NOTE: This equipment has been tested and found to comply with the limits for a Class A digital device, pursuant to part 15 of the FCC Rules. These limits are designed to provide reasonable protection against harmful interference when the equipment is operated in a commercial environment. This equipment generates, uses, and can radiate radio frequency energy and, if not installed and used in accordance with the instruction manual, may cause harmful interference to radio communications. Operation of this equipment in a residential area is likely to cause harmful interference in which case the user will be required to correct the interference at his own expense.

FCC Interference Statement for Class B EVM devices

NOTE: This equipment has been tested and found to comply with the limits for a Class B digital device, pursuant to part 15 of the FCC Rules. These limits are designed to provide reasonable protection against harmful interference in a residential installation. This equipment generates, uses and can radiate radio frequency energy and, if not installed and used in accordance with the instructions, may cause harmful interference to radio communications. However, there is no guarantee that interference will not occur in a particular installation. If this equipment does cause harmful interference to radio or television reception, which can be determined by turning the equipment off and on, the user is encouraged to try to correct the interference by one or more of the following measures:

- Reorient or relocate the receiving antenna.
- Increase the separation between the equipment and receiver.
- Connect the equipment into an outlet on a circuit different from that to which the receiver is connected.
- Consult the dealer or an experienced radio/TV technician for help.

3.2 Canada

3.2.1 For EVMs issued with an Industry Canada Certificate of Conformance to RSS-210

Concerning EVMs Including Radio Transmitters:

This device complies with Industry Canada license-exempt RSS standard(s). Operation is subject to the following two conditions: (1) this device may not cause interference, and (2) this device must accept any interference, including interference that may cause undesired operation of the device.

Concernant les EVMs avec appareils radio:

Le présent appareil est conforme aux CNR d'Industrie Canada applicables aux appareils radio exempts de licence. L'exploitation est autorisée aux deux conditions suivantes: (1) l'appareil ne doit pas produire de brouillage, et (2) l'utilisateur de l'appareil doit accepter tout brouillage radioélectrique subi, même si le brouillage est susceptible d'en compromettre le fonctionnement.

Concerning EVMs Including Detachable Antennas:

Under Industry Canada regulations, this radio transmitter may only operate using an antenna of a type and maximum (or lesser) gain approved for the transmitter by Industry Canada. To reduce potential radio interference to other users, the antenna type and its gain should be so chosen that the equivalent isotropically radiated power (e.i.r.p.) is not more than that necessary for successful communication. This radio transmitter has been approved by Industry Canada to operate with the antenna types listed in the user guide with the maximum permissible gain and required antenna impedance for each antenna type indicated. Antenna types not included in this list, having a gain greater than the maximum gain indicated for that type, are strictly prohibited for use with this device.

Concernant les EVMs avec antennes détachables

Conformément à la réglementation d'Industrie Canada, le présent émetteur radio peut fonctionner avec une antenne d'un type et d'un gain maximal (ou inférieur) approuvé pour l'émetteur par Industrie Canada. Dans le but de réduire les risques de brouillage radioélectrique à l'intention des autres utilisateurs, il faut choisir le type d'antenne et son gain de sorte que la puissance isotrope rayonnée équivalente (p.i.r.e.) ne dépasse pas l'intensité nécessaire à l'établissement d'une communication satisfaisante. Le présent émetteur radio a été approuvé par Industrie Canada pour fonctionner avec les types d'antenne énumérés dans le manuel d'usage et ayant un gain admissible maximal et l'impédance requise pour chaque type d'antenne. Les types d'antenne non inclus dans cette liste, ou dont le gain est supérieur au gain maximal indiqué, sont strictement interdits pour l'exploitation de l'émetteur.

3.3 Japan

3.3.1 *Notice for EVMs delivered in Japan:* Please see http://www.tij.co.jp/lstds/ti_ja/general/eStore/notice_01.page 日本国内に輸入される評価用キット、ボードについては、次のところをご覧ください。
http://www.tij.co.jp/lstds/ti_ja/general/eStore/notice_01.page

3.3.2 *Notice for Users of EVMs Considered "Radio Frequency Products" in Japan:* EVMs entering Japan may not be certified by TI as conforming to Technical Regulations of Radio Law of Japan.

If User uses EVMs in Japan, not certified to Technical Regulations of Radio Law of Japan, User is required by Radio Law of Japan to follow the instructions below with respect to EVMs:

1. Use EVMs in a shielded room or any other test facility as defined in the notification #173 issued by Ministry of Internal Affairs and Communications on March 28, 2006, based on Sub-section 1.1 of Article 6 of the Ministry's Rule for Enforcement of Radio Law of Japan,
2. Use EVMs only after User obtains the license of Test Radio Station as provided in Radio Law of Japan with respect to EVMs, or
3. Use of EVMs only after User obtains the Technical Regulations Conformity Certification as provided in Radio Law of Japan with respect to EVMs. Also, do not transfer EVMs, unless User gives the same notice above to the transferee. Please note that if User does not follow the instructions above, User will be subject to penalties of Radio Law of Japan.

【無線電波を送信する製品の開発キットをお使いになる際の注意事項】 開発キットの中には技術基準適合証明を受けていないものがあります。技術適合証明を受けていないものご使用に際しては、電波法遵守のため、以下のいずれかの措置を取っていただく必要がありますのでご注意ください。

1. 電波法施行規則第6条第1項第1号に基づく平成18年3月28日総務省告示第173号で定められた電波暗室等の試験設備でご使用いただく。
2. 実験局の免許を取得後ご使用いただく。
3. 技術基準適合証明を取得後ご使用いただく。

なお、本製品は、上記の「ご使用にあたっての注意」を譲渡先、移転先に通知しない限り、譲渡、移転できないものとします。

上記を遵守頂けない場合は、電波法の罰則が適用される可能性があることをご留意ください。日本テキサス・インスツルメンツ株式会社
東京都新宿区西新宿 6 丁目 2 4 番 1 号
西新宿三井ビル

3.3.3 *Notice for EVMs for Power Line Communication:* Please see http://www.tij.co.jp/llds/ti_ja/general/eStore/notice_02.page
電力線搬送波通信についての開発キットをお使いになる際の注意事項については、次のところをご覧ください。http://www.tij.co.jp/llds/ti_ja/general/eStore/notice_02.page

4 *EVM Use Restrictions and Warnings:*

4.1 EVMS ARE NOT FOR USE IN FUNCTIONAL SAFETY AND/OR SAFETY CRITICAL EVALUATIONS, INCLUDING BUT NOT LIMITED TO EVALUATIONS OF LIFE SUPPORT APPLICATIONS.

4.2 User must read and apply the user guide and other available documentation provided by TI regarding the EVM prior to handling or using the EVM, including without limitation any warning or restriction notices. The notices contain important safety information related to, for example, temperatures and voltages.

4.3 *Safety-Related Warnings and Restrictions:*

4.3.1 User shall operate the EVM within TI's recommended specifications and environmental considerations stated in the user guide, other available documentation provided by TI, and any other applicable requirements and employ reasonable and customary safeguards. Exceeding the specified performance ratings and specifications (including but not limited to input and output voltage, current, power, and environmental ranges) for the EVM may cause personal injury or death, or property damage. If there are questions concerning performance ratings and specifications, User should contact a TI field representative prior to connecting interface electronics including input power and intended loads. Any loads applied outside of the specified output range may also result in unintended and/or inaccurate operation and/or possible permanent damage to the EVM and/or interface electronics. Please consult the EVM user guide prior to connecting any load to the EVM output. If there is uncertainty as to the load specification, please contact a TI field representative. During normal operation, even with the inputs and outputs kept within the specified allowable ranges, some circuit components may have elevated case temperatures. These components include but are not limited to linear regulators, switching transistors, pass transistors, current sense resistors, and heat sinks, which can be identified using the information in the associated documentation. When working with the EVM, please be aware that the EVM may become very warm.

4.3.2 EVMs are intended solely for use by technically qualified, professional electronics experts who are familiar with the dangers and application risks associated with handling electrical mechanical components, systems, and subsystems. User assumes all responsibility and liability for proper and safe handling and use of the EVM by User or its employees, affiliates, contractors or designees. User assumes all responsibility and liability to ensure that any interfaces (electronic and/or mechanical) between the EVM and any human body are designed with suitable isolation and means to safely limit accessible leakage currents to minimize the risk of electrical shock hazard. User assumes all responsibility and liability for any improper or unsafe handling or use of the EVM by User or its employees, affiliates, contractors or designees.

4.4 User assumes all responsibility and liability to determine whether the EVM is subject to any applicable international, federal, state, or local laws and regulations related to User's handling and use of the EVM and, if applicable, User assumes all responsibility and liability for compliance in all respects with such laws and regulations. User assumes all responsibility and liability for proper disposal and recycling of the EVM consistent with all applicable international, federal, state, and local requirements.

5. *Accuracy of Information:* To the extent TI provides information on the availability and function of EVMs, TI attempts to be as accurate as possible. However, TI does not warrant the accuracy of EVM descriptions, EVM availability or other information on its websites as accurate, complete, reliable, current, or error-free.

6. *Disclaimers:*
- 6.1 EXCEPT AS SET FORTH ABOVE, EVMS AND ANY WRITTEN DESIGN MATERIALS PROVIDED WITH THE EVM (AND THE DESIGN OF THE EVM ITSELF) ARE PROVIDED "AS IS" AND "WITH ALL FAULTS." TI DISCLAIMS ALL OTHER WARRANTIES, EXPRESS OR IMPLIED, REGARDING SUCH ITEMS, INCLUDING BUT NOT LIMITED TO ANY IMPLIED WARRANTIES OF MERCHANTABILITY OR FITNESS FOR A PARTICULAR PURPOSE OR NON-INFRINGEMENT OF ANY THIRD PARTY PATENTS, COPYRIGHTS, TRADE SECRETS OR OTHER INTELLECTUAL PROPERTY RIGHTS.
- 6.2 EXCEPT FOR THE LIMITED RIGHT TO USE THE EVM SET FORTH HEREIN, NOTHING IN THESE TERMS AND CONDITIONS SHALL BE CONSTRUED AS GRANTING OR CONFERRING ANY RIGHTS BY LICENSE, PATENT, OR ANY OTHER INDUSTRIAL OR INTELLECTUAL PROPERTY RIGHT OF TI, ITS SUPPLIERS/LICENSORS OR ANY OTHER THIRD PARTY, TO USE THE EVM IN ANY FINISHED END-USER OR READY-TO-USE FINAL PRODUCT, OR FOR ANY INVENTION, DISCOVERY OR IMPROVEMENT MADE, CONCEIVED OR ACQUIRED PRIOR TO OR AFTER DELIVERY OF THE EVM.
7. *USER'S INDEMNITY OBLIGATIONS AND REPRESENTATIONS.* USER WILL DEFEND, INDEMNIFY AND HOLD TI, ITS LICENSORS AND THEIR REPRESENTATIVES HARMLESS FROM AND AGAINST ANY AND ALL CLAIMS, DAMAGES, LOSSES, EXPENSES, COSTS AND LIABILITIES (COLLECTIVELY, "CLAIMS") ARISING OUT OF OR IN CONNECTION WITH ANY HANDLING OR USE OF THE EVM THAT IS NOT IN ACCORDANCE WITH THESE TERMS AND CONDITIONS. THIS OBLIGATION SHALL APPLY WHETHER CLAIMS ARISE UNDER STATUTE, REGULATION, OR THE LAW OF TORT, CONTRACT OR ANY OTHER LEGAL THEORY, AND EVEN IF THE EVM FAILS TO PERFORM AS DESCRIBED OR EXPECTED.
8. *Limitations on Damages and Liability:*
- 8.1 *General Limitations.* IN NO EVENT SHALL TI BE LIABLE FOR ANY SPECIAL, COLLATERAL, INDIRECT, PUNITIVE, INCIDENTAL, CONSEQUENTIAL, OR EXEMPLARY DAMAGES IN CONNECTION WITH OR ARISING OUT OF THESE TERMS AND CONDITIONS OR THE USE OF THE EVMS PROVIDED HEREUNDER, REGARDLESS OF WHETHER TI HAS BEEN ADVISED OF THE POSSIBILITY OF SUCH DAMAGES. EXCLUDED DAMAGES INCLUDE, BUT ARE NOT LIMITED TO, COST OF REMOVAL OR REINSTALLATION, ANCILLARY COSTS TO THE PROCUREMENT OF SUBSTITUTE GOODS OR SERVICES, RETESTING, OUTSIDE COMPUTER TIME, LABOR COSTS, LOSS OF GOODWILL, LOSS OF PROFITS, LOSS OF SAVINGS, LOSS OF USE, LOSS OF DATA, OR BUSINESS INTERRUPTION. NO CLAIM, SUIT OR ACTION SHALL BE BROUGHT AGAINST TI MORE THAN ONE YEAR AFTER THE RELATED CAUSE OF ACTION HAS OCCURRED.
- 8.2 *Specific Limitations.* IN NO EVENT SHALL TI'S AGGREGATE LIABILITY FROM ANY WARRANTY OR OTHER OBLIGATION ARISING OUT OF OR IN CONNECTION WITH THESE TERMS AND CONDITIONS, OR ANY USE OF ANY TI EVM PROVIDED HEREUNDER, EXCEED THE TOTAL AMOUNT PAID TO TI FOR THE PARTICULAR UNITS SOLD UNDER THESE TERMS AND CONDITIONS WITH RESPECT TO WHICH LOSSES OR DAMAGES ARE CLAIMED. THE EXISTENCE OF MORE THAN ONE CLAIM AGAINST THE PARTICULAR UNITS SOLD TO USER UNDER THESE TERMS AND CONDITIONS SHALL NOT ENLARGE OR EXTEND THIS LIMIT.
9. *Return Policy.* Except as otherwise provided, TI does not offer any refunds, returns, or exchanges. Furthermore, no return of EVM(s) will be accepted if the package has been opened and no return of the EVM(s) will be accepted if they are damaged or otherwise not in a resalable condition. If User feels it has been incorrectly charged for the EVM(s) it ordered or that delivery violates the applicable order, User should contact TI. All refunds will be made in full within thirty (30) working days from the return of the components(s), excluding any postage or packaging costs.
10. *Governing Law:* These terms and conditions shall be governed by and interpreted in accordance with the laws of the State of Texas, without reference to conflict-of-laws principles. User agrees that non-exclusive jurisdiction for any dispute arising out of or relating to these terms and conditions lies within courts located in the State of Texas and consents to venue in Dallas County, Texas. Notwithstanding the foregoing, any judgment may be enforced in any United States or foreign court, and TI may seek injunctive relief in any United States or foreign court.

Mailing Address: Texas Instruments, Post Office Box 655303, Dallas, Texas 75265
Copyright © 2015, Texas Instruments Incorporated

IMPORTANT NOTICE

Texas Instruments Incorporated and its subsidiaries (TI) reserve the right to make corrections, enhancements, improvements and other changes to its semiconductor products and services per JESD46, latest issue, and to discontinue any product or service per JESD48, latest issue. Buyers should obtain the latest relevant information before placing orders and should verify that such information is current and complete. All semiconductor products (also referred to herein as "components") are sold subject to TI's terms and conditions of sale supplied at the time of order acknowledgment.

TI warrants performance of its components to the specifications applicable at the time of sale, in accordance with the warranty in TI's terms and conditions of sale of semiconductor products. Testing and other quality control techniques are used to the extent TI deems necessary to support this warranty. Except where mandated by applicable law, testing of all parameters of each component is not necessarily performed.

TI assumes no liability for applications assistance or the design of Buyers' products. Buyers are responsible for their products and applications using TI components. To minimize the risks associated with Buyers' products and applications, Buyers should provide adequate design and operating safeguards.

TI does not warrant or represent that any license, either express or implied, is granted under any patent right, copyright, mask work right, or other intellectual property right relating to any combination, machine, or process in which TI components or services are used. Information published by TI regarding third-party products or services does not constitute a license to use such products or services or a warranty or endorsement thereof. Use of such information may require a license from a third party under the patents or other intellectual property of the third party, or a license from TI under the patents or other intellectual property of TI.

Reproduction of significant portions of TI information in TI data books or data sheets is permissible only if reproduction is without alteration and is accompanied by all associated warranties, conditions, limitations, and notices. TI is not responsible or liable for such altered documentation. Information of third parties may be subject to additional restrictions.

Resale of TI components or services with statements different from or beyond the parameters stated by TI for that component or service voids all express and any implied warranties for the associated TI component or service and is an unfair and deceptive business practice. TI is not responsible or liable for any such statements.

Buyer acknowledges and agrees that it is solely responsible for compliance with all legal, regulatory and safety-related requirements concerning its products, and any use of TI components in its applications, notwithstanding any applications-related information or support that may be provided by TI. Buyer represents and agrees that it has all the necessary expertise to create and implement safeguards which anticipate dangerous consequences of failures, monitor failures and their consequences, lessen the likelihood of failures that might cause harm and take appropriate remedial actions. Buyer will fully indemnify TI and its representatives against any damages arising out of the use of any TI components in safety-critical applications.

In some cases, TI components may be promoted specifically to facilitate safety-related applications. With such components, TI's goal is to help enable customers to design and create their own end-product solutions that meet applicable functional safety standards and requirements. Nonetheless, such components are subject to these terms.

No TI components are authorized for use in FDA Class III (or similar life-critical medical equipment) unless authorized officers of the parties have executed a special agreement specifically governing such use.

Only those TI components which TI has specifically designated as military grade or "enhanced plastic" are designed and intended for use in military/aerospace applications or environments. Buyer acknowledges and agrees that any military or aerospace use of TI components which have **not** been so designated is solely at the Buyer's risk, and that Buyer is solely responsible for compliance with all legal and regulatory requirements in connection with such use.

TI has specifically designated certain components as meeting ISO/TS16949 requirements, mainly for automotive use. In any case of use of non-designated products, TI will not be responsible for any failure to meet ISO/TS16949.

Products

Audio	www.ti.com/audio
Amplifiers	amplifier.ti.com
Data Converters	dataconverter.ti.com
DLP® Products	www.dlp.com
DSP	dsp.ti.com
Clocks and Timers	www.ti.com/clocks
Interface	interface.ti.com
Logic	logic.ti.com
Power Mgmt	power.ti.com
Microcontrollers	microcontroller.ti.com
RFID	www.ti-rfid.com
OMAP Applications Processors	www.ti.com/omap
Wireless Connectivity	www.ti.com/wirelessconnectivity

Applications

Automotive and Transportation	www.ti.com/automotive
Communications and Telecom	www.ti.com/communications
Computers and Peripherals	www.ti.com/computers
Consumer Electronics	www.ti.com/consumer-apps
Energy and Lighting	www.ti.com/energy
Industrial	www.ti.com/industrial
Medical	www.ti.com/medical
Security	www.ti.com/security
Space, Avionics and Defense	www.ti.com/space-avionics-defense
Video and Imaging	www.ti.com/video

TI E2E Community

e2e.ti.com