

MAX14933/MAX14937 Evaluation Kit

Evaluates: MAX14933, MAX14937

General Description

The MAX14933/MAX14937 evaluation kit (EV kit) is a fully assembled and tested circuit board that demonstrates the functionality of the MAX14933/MAX14937 2-channel digital isolators in a 16-pin, wide-body SOIC surface-mount package. The EV kit features two independent isolated power supplies independently adjustable to +5V.

Features

- Ease of Use
 - Easy Powering Through Micro-USB or Test Points
 - SMA Connectors to Connect to External Equipment
- Guaranteed 5kV_{RMS} Isolation
- Fully Assembled and Tested.

Ordering Information appears at end of data sheet.

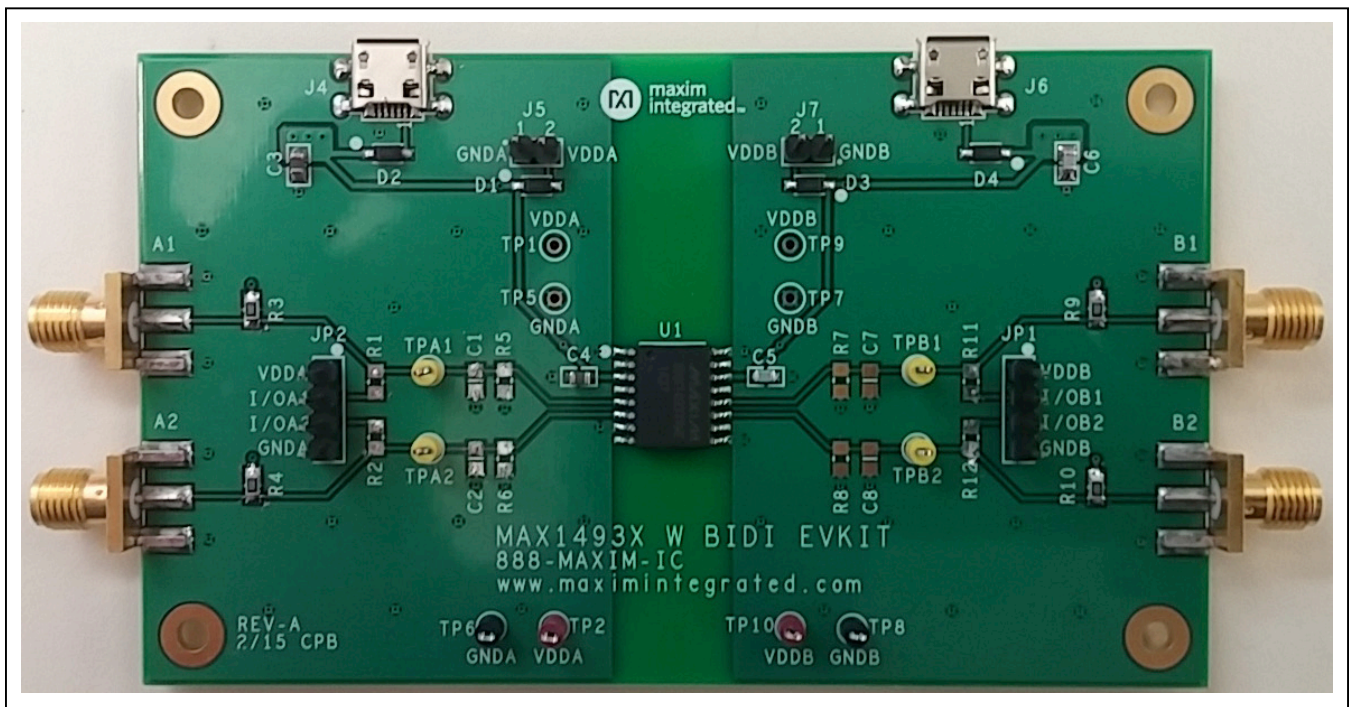

Quick Start

Required Equipment

- MAX14933/MAX14937 EV kit
- Two 5V DC power supplies or USB cables with a micro-B connector
- Signal/function generator
- Oscilloscope

Procedure

The EV kit is fully assembled and tested. Follow the steps below to verify board operation:

- 1) Connect the DC power supplies between the EV kit's VDDA/VDDDB and GNDA/GNDB test points.
- 2) Turn on the DC power supply and set it to 5V, then enable the power-supply output.
Note: *It is also possible to power the EV kit with standard USB ports. To do so, connect the micro-B end of the USB cables into PA/PB on the board. Connect the A-end of the USB cable into the USB ports.*
- 3) Connect any signal to the SMA connectors or test points and observe the isolated signal on the other side using an oscilloscope.

Detailed Description of Hardware (or Software)

The MAX14933/MAX14937 EV kit is a fully assembled and tested circuit board for evaluating the MAX14933/MAX14937 2-channel digital isolators in a 16-pin, wide-body SOIC package. The EV kit is powered from two +5V supplies, as described below.

External Power Supply

Power on the EV kit is derived from two +5V sources. Connect external supplies to the +5V and GNDA test points, or connect a micro-B USB cable to the on-board PA/PB connectors to provide the 5V supply. Both options have a reverse-current protection diode.

The devices level-shift the data and control signals, transmitting them across the isolation barrier. Each supply can be set independently and be present over the entire specified range of the device, regardless of the level or presence of the other supply.

The devices can be used to transmit signals on isolated I²C serial buses. Connect signals as shown in [Table 1](#) to evaluate isolated I²C operation.

A simplified schematic showing the connections for evaluating the devices in an isolated I²C interface is attached to this data sheet. The devices level-shift the data and clock signals, transmitting them across the isolation barrier.

Jumpers

Two jumpers (POWA/POWB) are provided to switch between powering the EV kit using micro-USB supplies or jumpers. When the jumpers are connected, the EV kit is powered from the micro-USB ports. In this case, no external supply should be connected to VDDA/VDDDB.

Pullups

All inputs and outputs are pulled up to the corresponding V_{DD} with a 4.7K resistor. The user has the option of adding a resistor or capacitor to ground, or a series resistor depending on their particular needs.

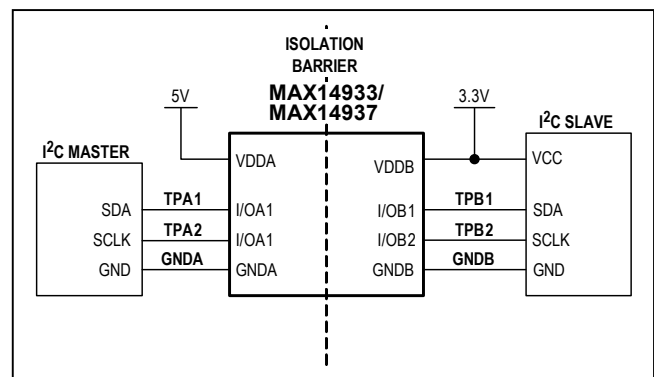

Figure 1. Simplified Schematic

Table 1. MAX14933/MAX14937 Connections for Isolated I²C Evaluation

| MAX14933/MAX14937 PIN | TEST POINT CONNECTION | DESCRIPTION |
|-----------------------|-----------------------|-------------|
| I/OA1 | TPA1 | SDA |
| I/OA2 | TPA2 | SCLK |

Component Information, PCB Files, and Schematic

See the following links for component information, PCB files, and schematics:

- [MAX14933/MAX14937 EV BOM](#)
- [MAX14933/MAX14937 EV PCB](#)
- [MAX14933/MAX14937 EV Schematic](#)

Ordering Information

| PART | TYPE |
|-----------------|--------|
| MAX14933WEVKIT# | EV Kit |
| MAX14937WEVKIT# | EV Kit |

#Denotes RoHS compliant.

Revision History

| REVISION NUMBER | REVISION DATE | DESCRIPTION | PAGES CHANGED |
|-----------------|---------------|-----------------|---------------|
| 0 | 5/15 | Initial release | — |

For pricing, delivery, and ordering information, please contact Maxim Direct at 1-888-629-4642, or visit Maxim Integrated's website at www.maximintegrated.com.

Maxim Integrated cannot assume responsibility for use of any circuitry other than circuitry entirely embodied in a Maxim Integrated product. No circuit patent licenses are implied. Maxim Integrated reserves the right to change the circuitry and specifications without notice at any time.

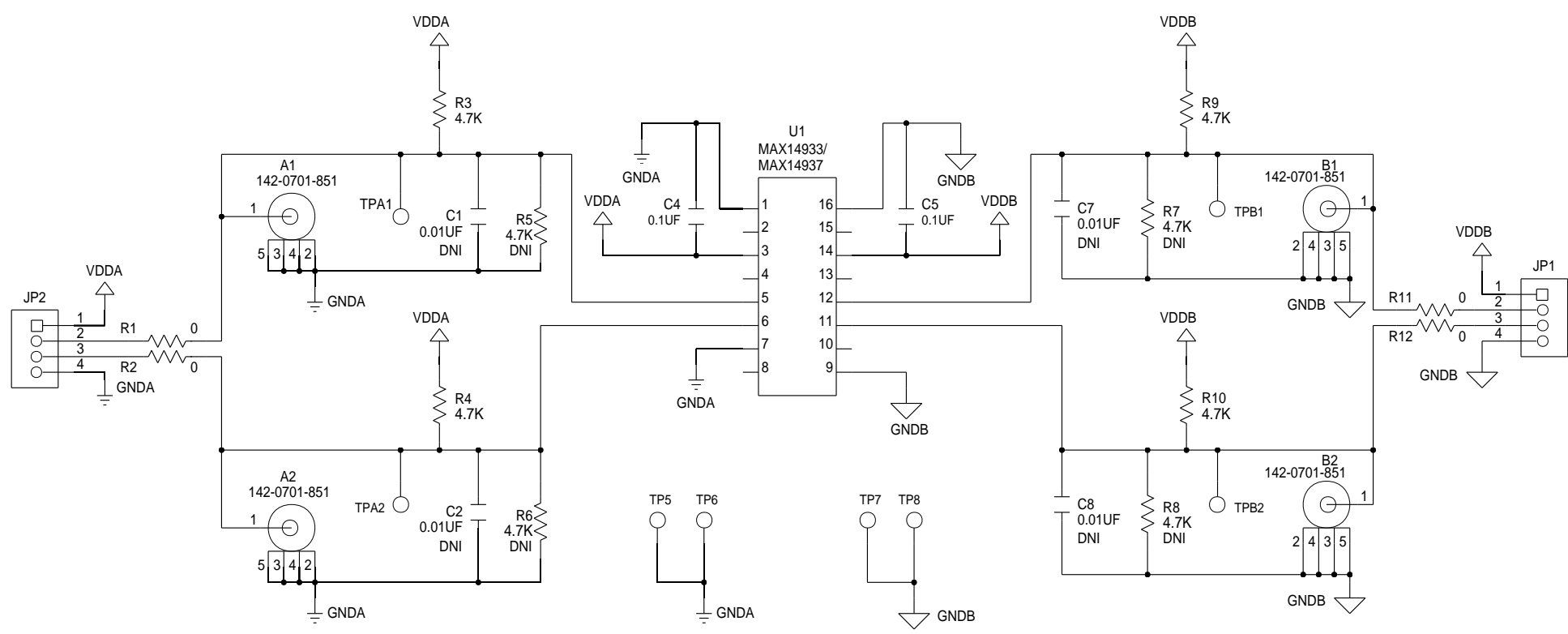
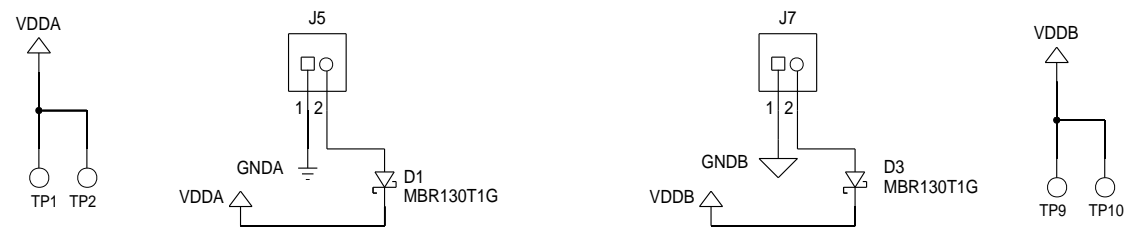
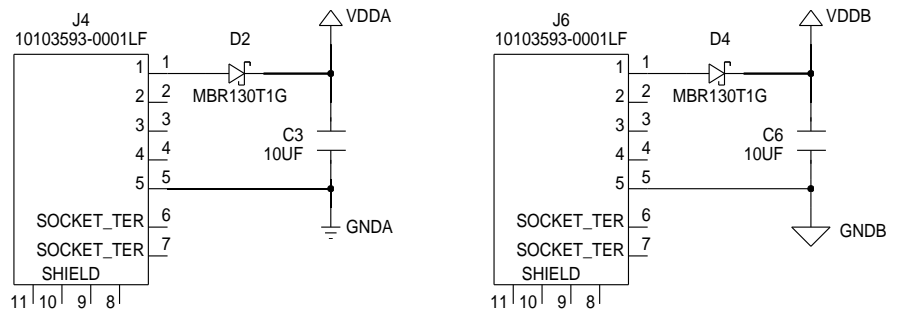

| | | |
|--|---------------------------------------|-------------------|
| PROJECT TITLE: MAX1493X W BIDI EVKIT | | |
| DRAWING TITLE: | | |
| SIZE B | HARDWARE NUMBER: <HARDWARE_NUMBER> | DATE: 02/24/15 |
| ENGINEER: <ENGINEER> | DRAWN BY: <DRAWN_BY> | REV: A |
| TEMPLATE REV: 1.5 | | SHEET 1 OF 1 |



This document contains information considered proprietary, and shall not be reproduced wholly or in part, nor disclosed to others without specific written permission.

HARDWARE NAME: MAX1493X_W_BIDI_EVKIT_A

HARDWARE NUMBER:

ENGINEER:

DESIGNER:

DATE: 02/25/2015

ODB++/GERBER: TOP

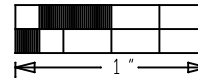
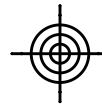
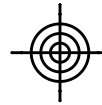
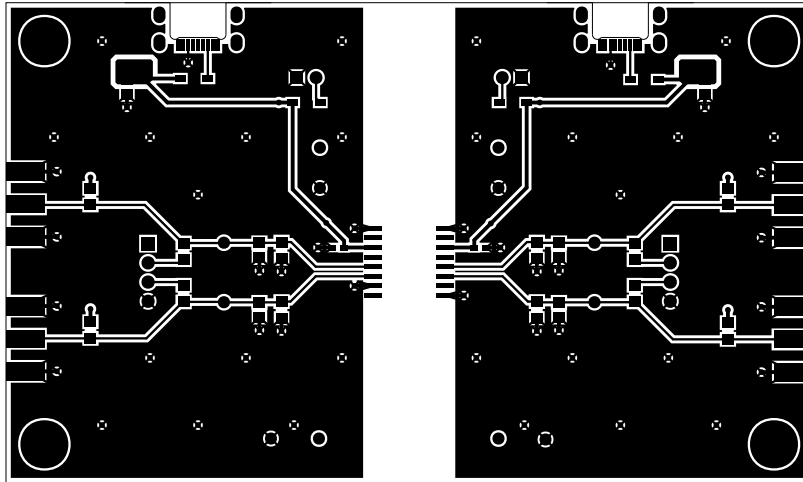



This document contains information considered proprietary, and shall not be reproduced wholly or in part, nor disclosed to others without specific written permission.

HARDWARE NAME: MAX1493X_W_BIDI_EVKIT_A

HARDWARE NUMBER:

ENGINEER:

DESIGNER:

DATE: 02/25/2015

ODB++/GERBER: L2_GND

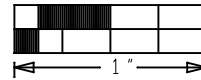
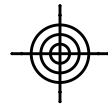
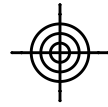
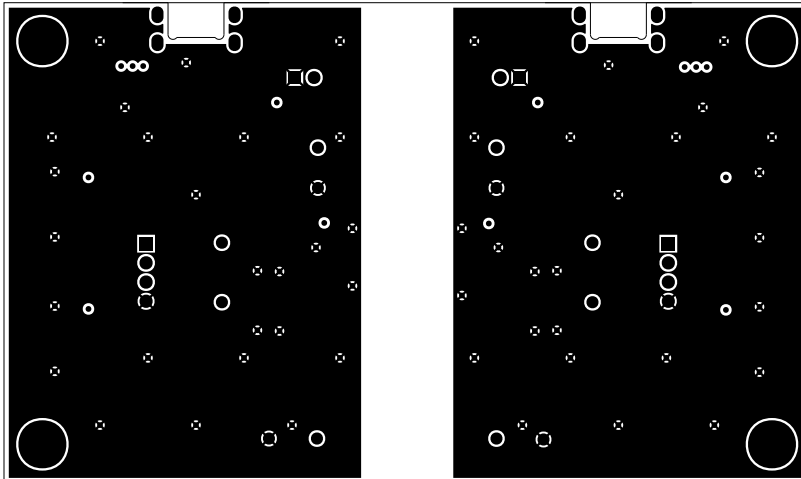



This document contains information considered proprietary, and shall not be reproduced wholly or in part, nor disclosed to others without specific written permission.

HARDWARE NAME: MAX1493X_W_BIDI_EVKIT_A

HARDWARE NUMBER:

ENGINEER:

DESIGNER:

DATE: 02/25/2015

ODB++/GERBER: L3_PWR

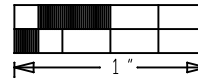
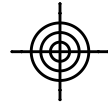
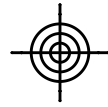
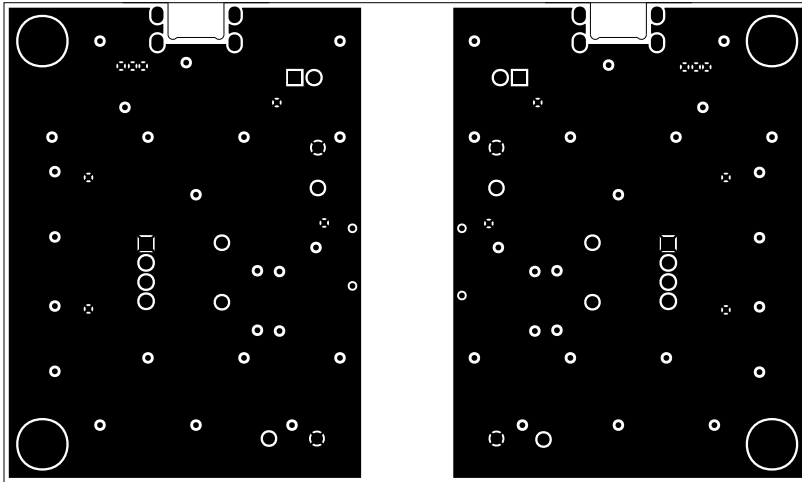



This document contains information considered proprietary, and shall not be reproduced wholly or in part, nor disclosed to others without specific written permission.

HARDWARE NAME: MAX1493X_W_BIDI_EVKIT_A

HARDWARE NUMBER:

ENGINEER:

DESIGNER:

DATE: 02/25/2015

ODB++/GERBER: BOTTOM

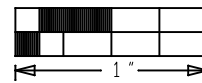
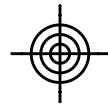
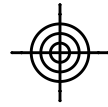
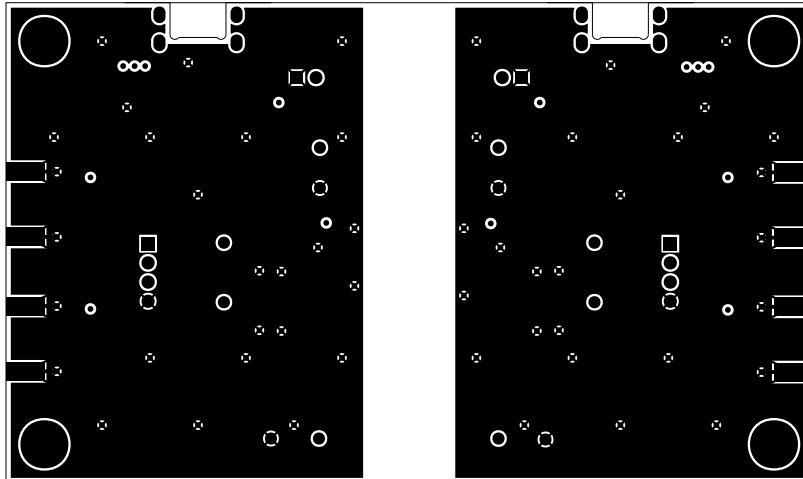

BILL OF MATERIALS (BOM)

| ITEM | QTY | REF DES | DESCRIPTION | MFG PART # |
|------|-----|------------------------|---|-------------------|
| 1 | 4 | A1, A2, B1, B2 | CONNECTOR; END LAUNCH JACK RECEPTACLE; BOARDMOUNT; STRAIGHT THROUGH; 2PINS; | 142-0701-801 |
| 2 | 2 | C3, C6 | CAPACITOR; SMT (0805); CERAMIC CHIP; 10UF; 10V; | LMK212F106ZG-T |
| 3 | 2 | C4, C5 | CAPACITOR; SMT (0603); CERAMIC CHIP; 0.1UF; 16V; | EMK107BJ104KAH |
| 4 | 4 | D1-D4 | DIODE; SCH; SCHÖTTKY POWER RECTIFIER; SMT (SOD-123); PIV=30V; IF=1.0A | MBR130T1G |
| 5 | 2 | J4, J6 | CONNECTOR; FEMALE; BOARDMOUNT; MICRO USB B-TYPE MID- MOUNT; RIGHT ANGLE; 5PINS | 10103593-0001LF |
| 6 | 2 | J5, J7 | CONNECTOR; MALE; THROUGH HOLE; BREAKAWAY; STRAIGHT; 2PINS | 961102-6404-AR |
| 7 | 2 | JP1, JP2 | CONNECTOR; MALE; THROUGH HOLE; BREAKAWAY; STRAIGHT; 4PINS | 961104-6804-AR |
| 8 | 4 | R1, R2, R11, R12 | RESISTOR; 0805; 0 OHM; 5%; JUMPER; 0.125W; THICK FILM | AC0805FR-070RL |
| 9 | 4 | R3, R4, R9, R10 | RESISTOR; 0805; 4.7K OHM; 5%; 200PPM; 0.25W; THICK FILM | ERJ-P06J472V |
| 10 | 4 | TP1, TP2, TP9, TP10 | TEST POINT | 5000 |
| 11 | 4 | TP5-TP8 | TEST POINT | 5001 |
| 12 | 4 | TPA1, TPA2, TPB1, TPB2 | TEST POINT | 5004 |
| 14 | 4 | C1, C2, C7, C8 | CAPACITOR; SMT; 0805; CERAMIC; 0.01uF; 50V; 5%; | GRM2195C1H103JA01 |
| 15 | 4 | R5-R8 | RESISTOR; 0805; 4.7K OHM; 5%; 200PPM; 0.25W; THICK FILM | ERJ-P06J472V |