



**ON Semiconductor®**

# **Test Procedure for the NCP1566 3.3-V/30-A Dc-Dc Converter**

---

Christophe Basso

October 30<sup>th</sup> 2017

Rev. 2



# Board Electrical Schematic

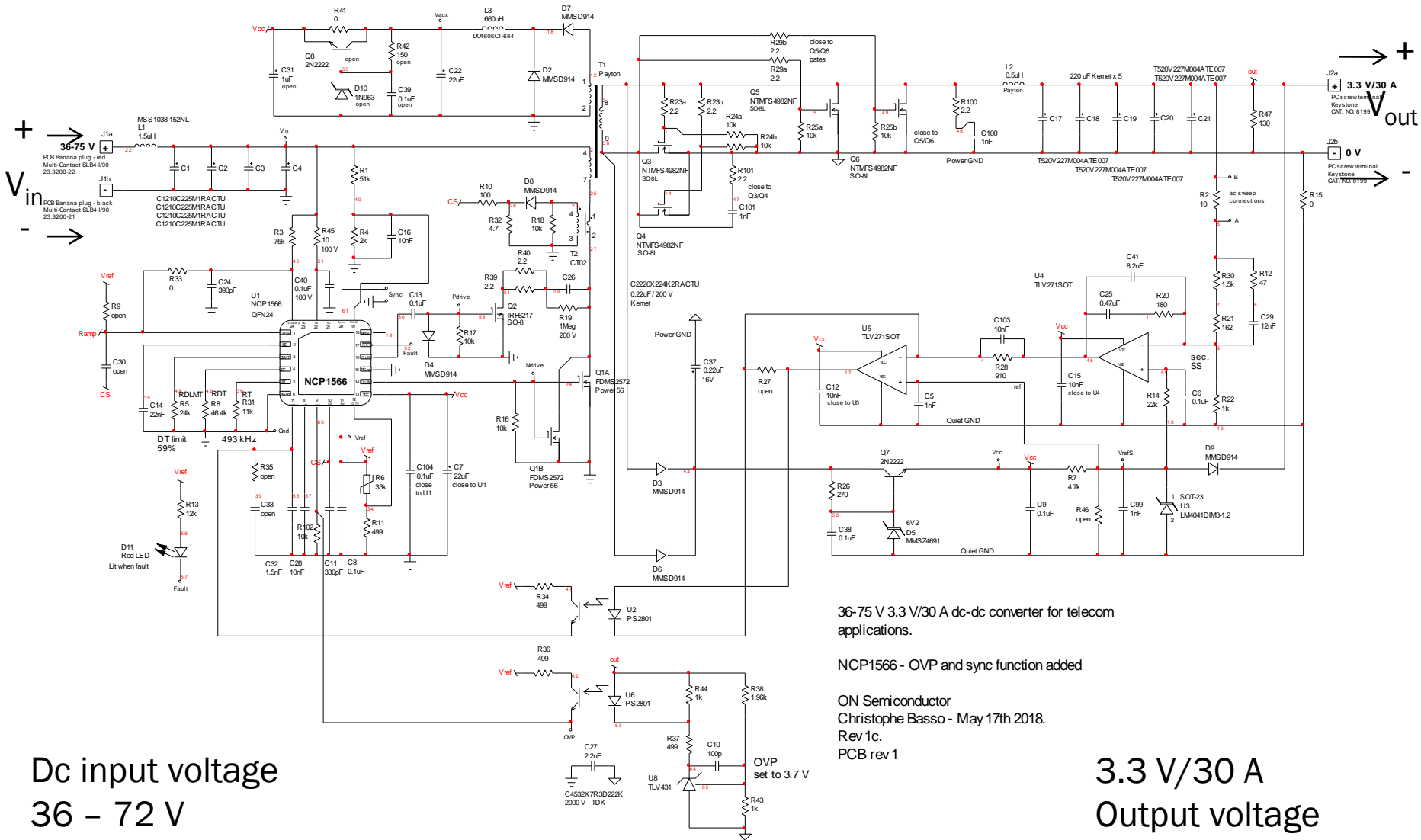

36-75 V 3.3 V/30 A dc-dc converter for telecom applications.

NCP1566 - OVP and sync function added

ON Semiconductor  
 Christophe Basso - May 17th 2018.  
 Rev 1c.  
 PCB rev 1

Dc input voltage  
 36 - 72 V

3.3 V/30 A  
 Output voltage



# Board Picture

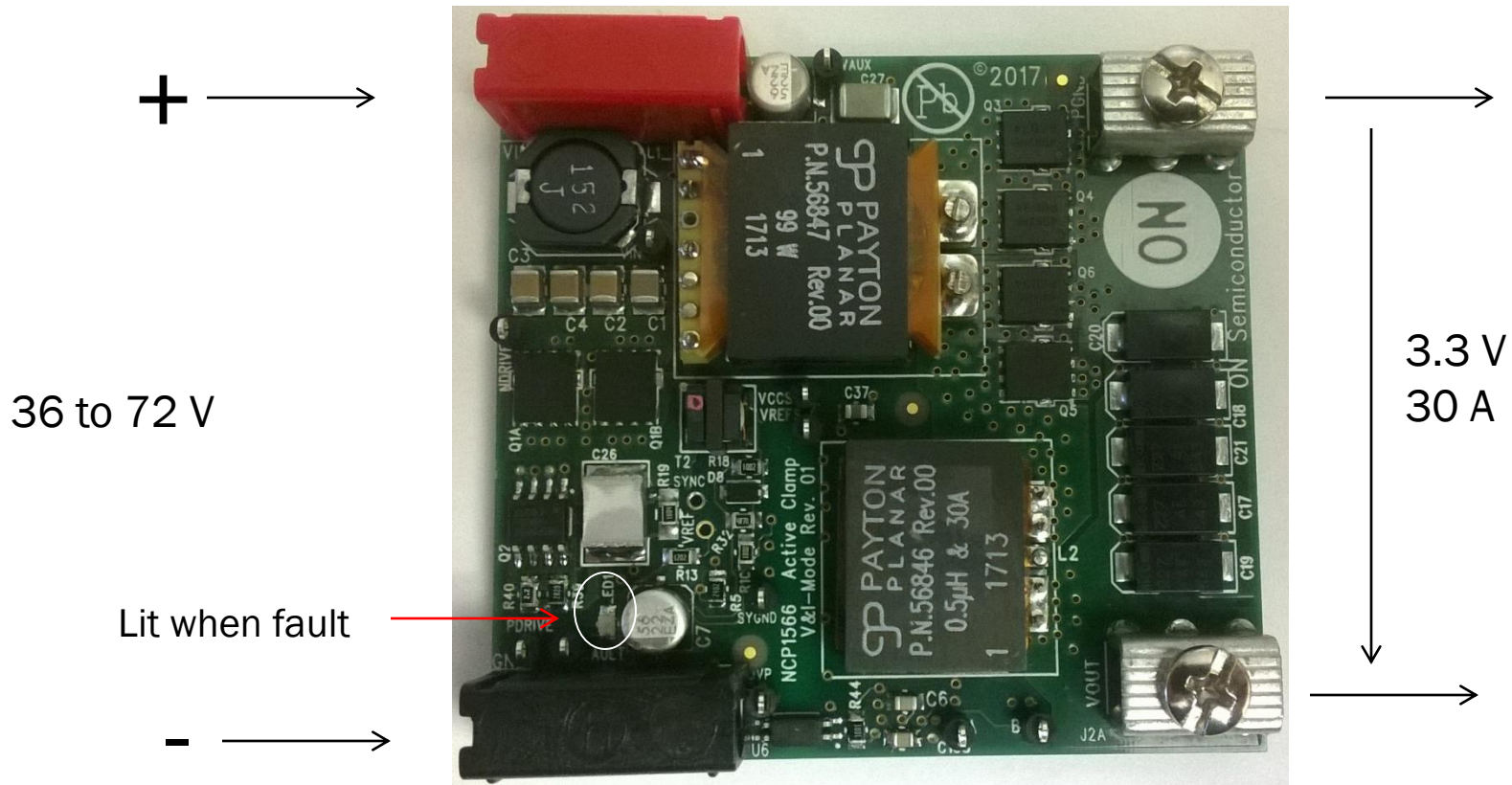

Input voltage from 36 V to 72 V dc. Nominal input is 48 V

Output voltage is 3.3 V nominal current is 30 A

NCP1566TELECGEVB

# Needed Equipment

The needed equipments are the following:

- ❑ a dc voltage source, delivering up to 80 V dc and up to 5 A
  - ❑ a dc load absorbing up to 100 W,  $V_{in,max} < 20\text{ V}$ ,  $I_{out,max} < 40\text{ A}$
  - ❑ either the above load can display dc V and dc A or separated V and A-meters are necessary
  - ❑ An oscilloscope with single shot capability
- *Kelvin sensing is necessary to connect the load to the board. If no precautions are taken, it is likely that the voltage drop at the load cables ends induces a reading error*

# Basic Test Setup

source



load

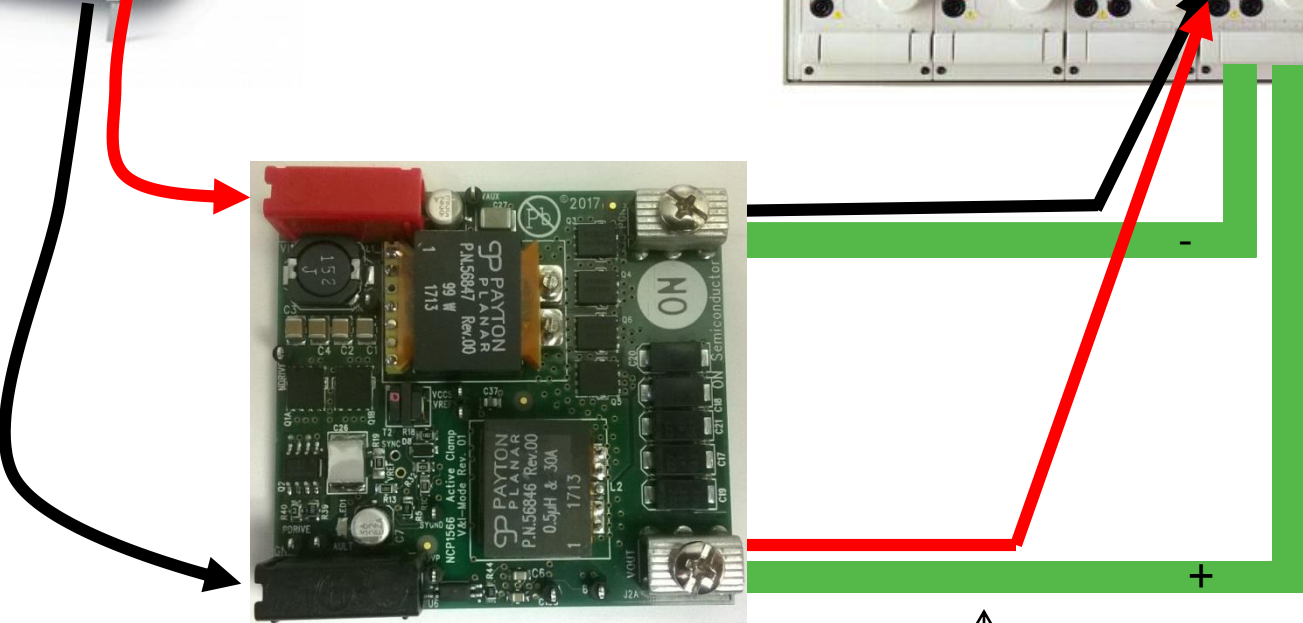
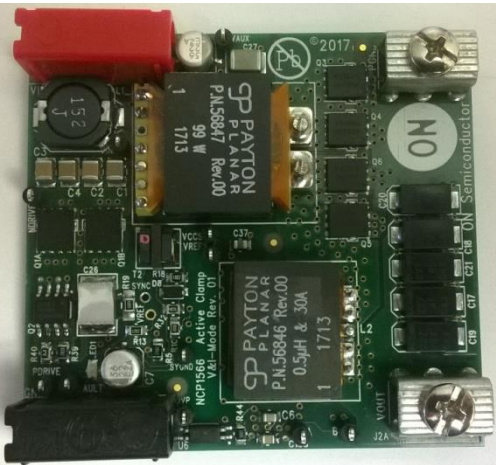
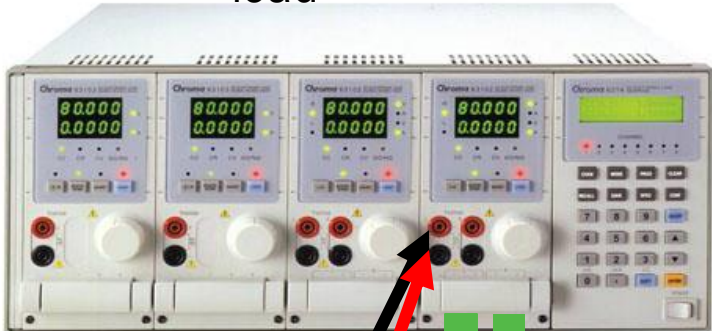

Kelvin sense



# Test n°1

source

load

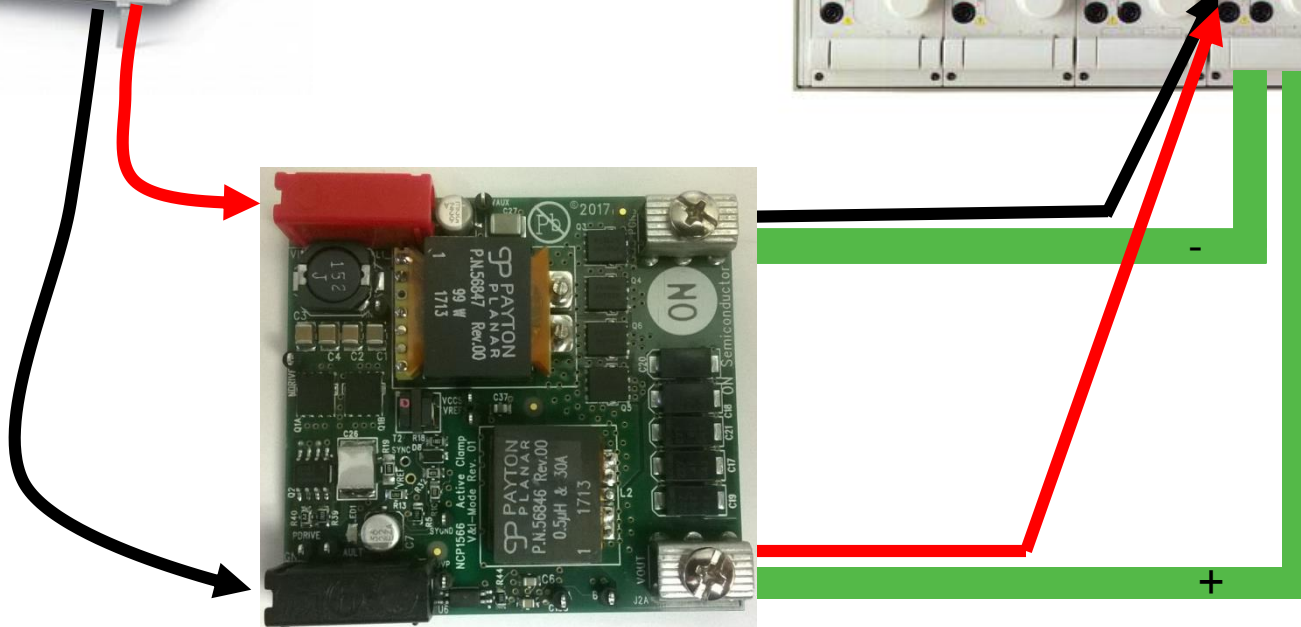
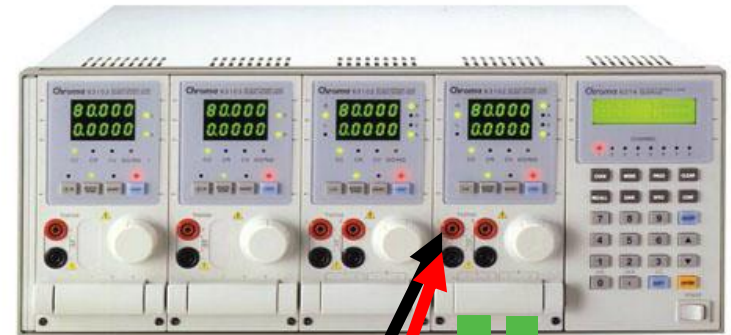

- Start the power supply while the load current is 30 A
- Monitor the output voltage on a scope
- Verify the voltage is monotonically rising



# Test n°1

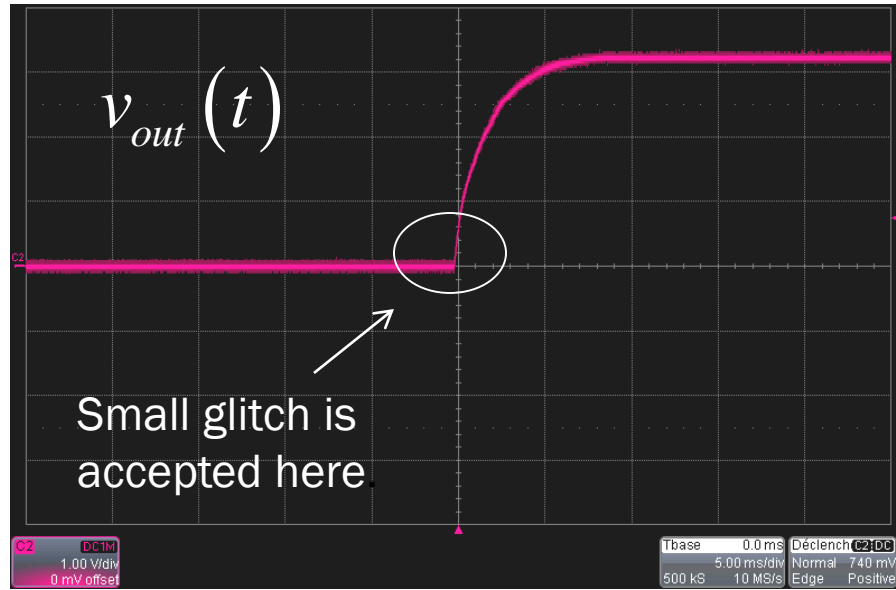

Ok

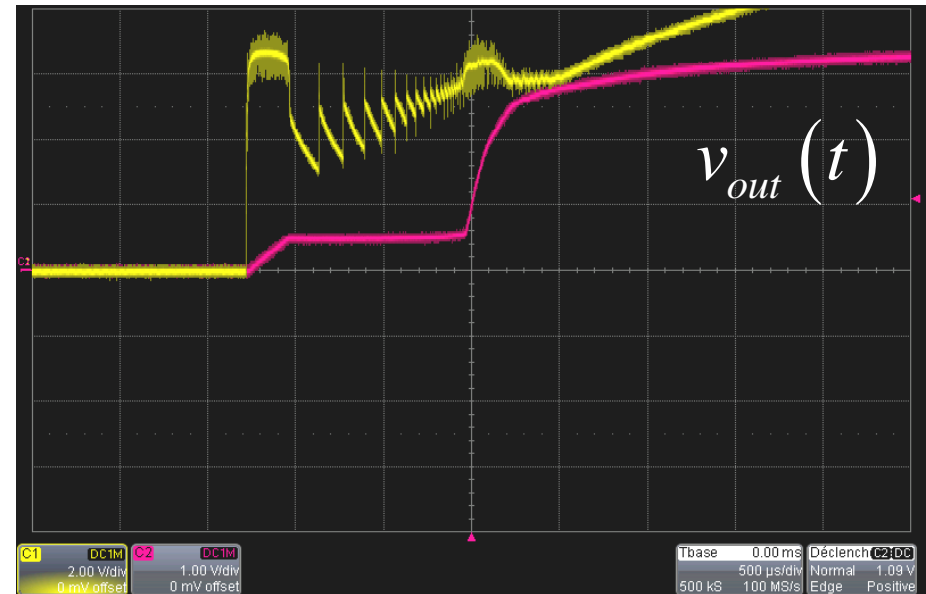

Bad

- It is important to verify the absence of double slope
- Repeat the test for  $V_{in} = 48\text{ V}$  and  $72\text{ V}$
- Change load to  $0\text{ A}$ , repeat tests. Wait  $10\text{ s}$  between re-starts
- A small glitch at the beginning of the rising edge is acceptable

# Test n°2

source



load

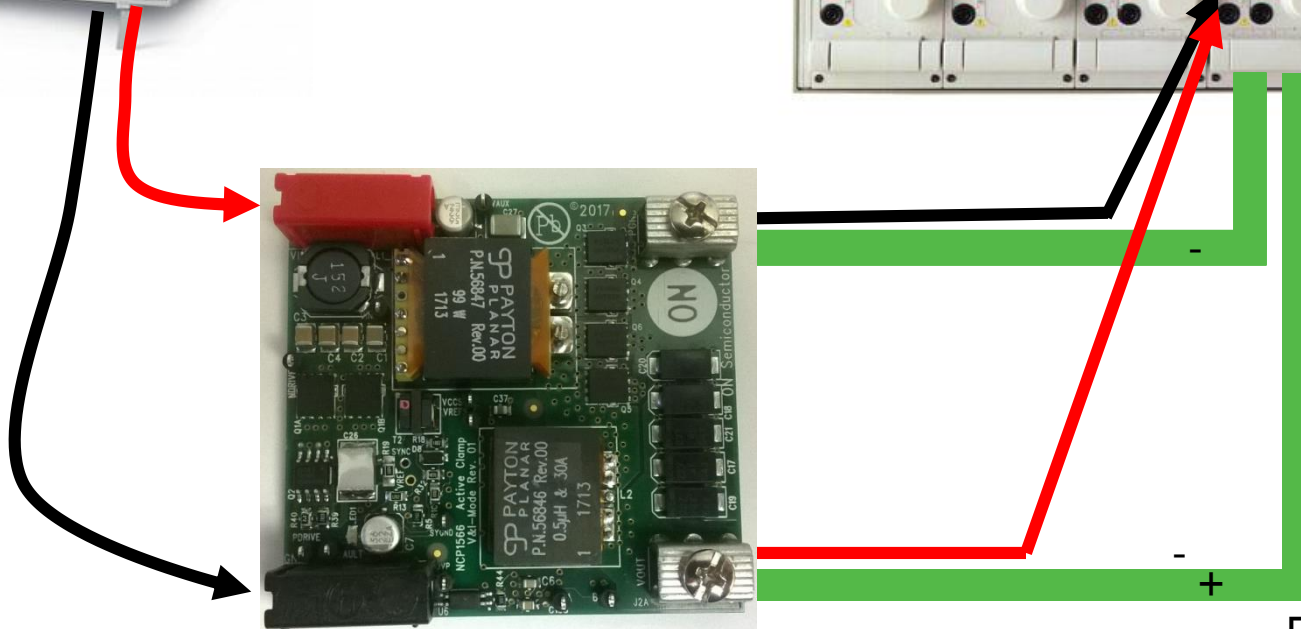
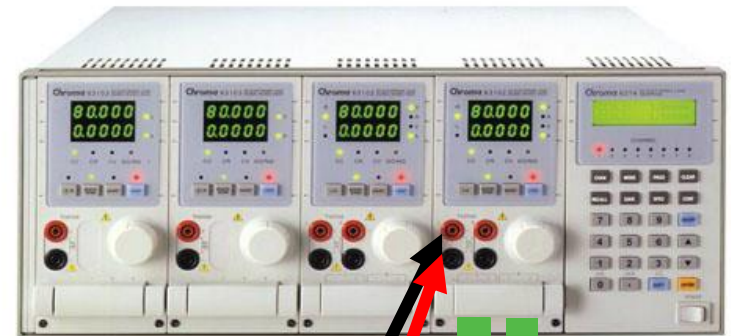

- Press short circuit at  $V_{in} = 36\text{ V}$ ,  $I_{out} = 30\text{ A}$ . Led is lit, board ticks.
- Repeat test for  $V_{in} = 72\text{ V}$
- Release short and make sure output resumes at 3.3 V

Press short



# Test n°3

source



load

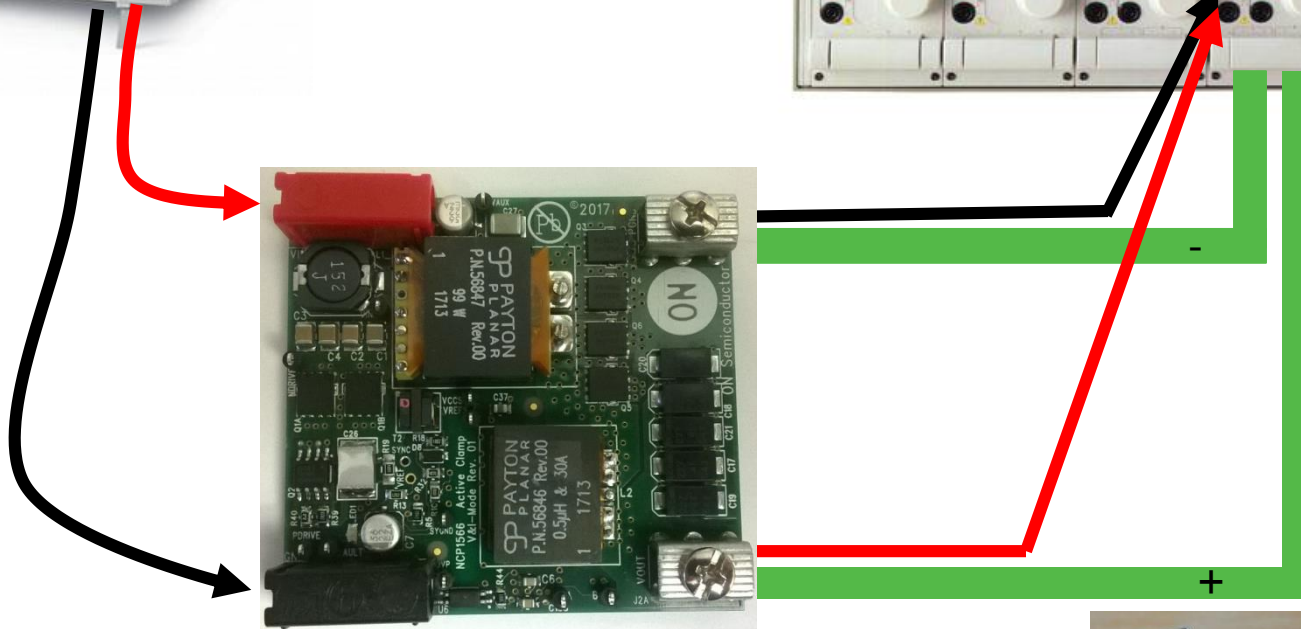
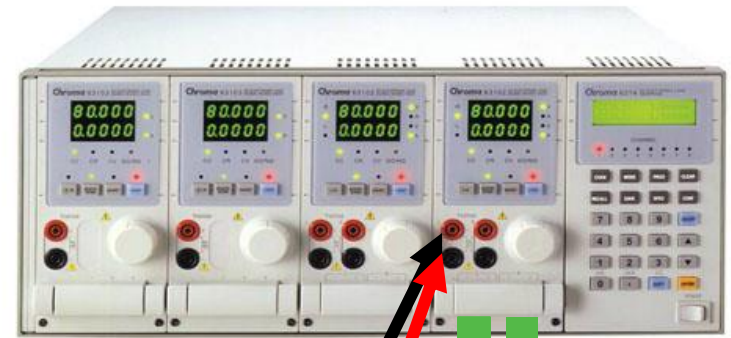

- Program load to dynamic current mode
- $I_{out}$  from 20 A to 15 A, slope 1 A/ $\mu$ s
- 1 ms interval, observe  $V_{out}$  on scope in ac, 20 mV/div



No pigtail!

# Test n°3

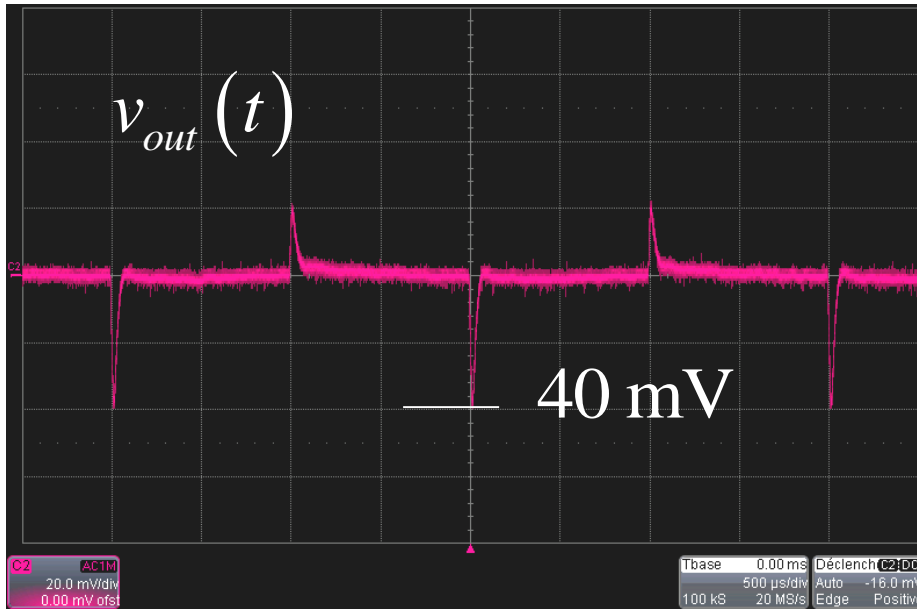

$V_{in} = 36 \text{ V}$   $I_{out} = 15 \text{ to } 20 \text{ A}, 1 \text{ A}/\mu\text{s}$

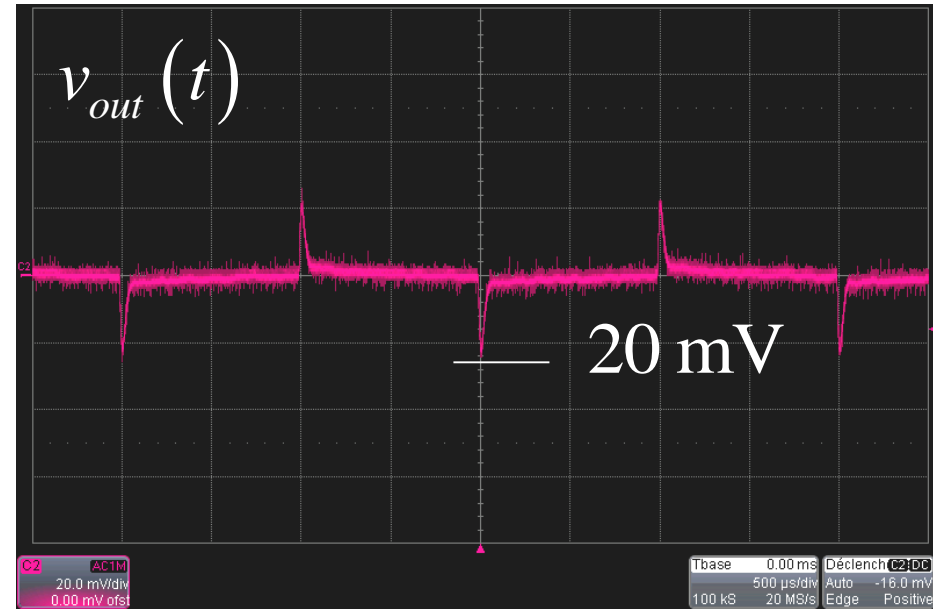

$V_{in} = 48 \text{ V}$   $I_{out} = 15 \text{ to } 20 \text{ A}, 1 \text{ A}/\mu\text{s}$

- Run the test from  $V_{in} = 36 \text{ V}$  (worst case) to  $V_{in} = 72 \text{ V}$ .
- Spec is to have an under/over shoot less than 60 mV

# Test n° 4

source



load

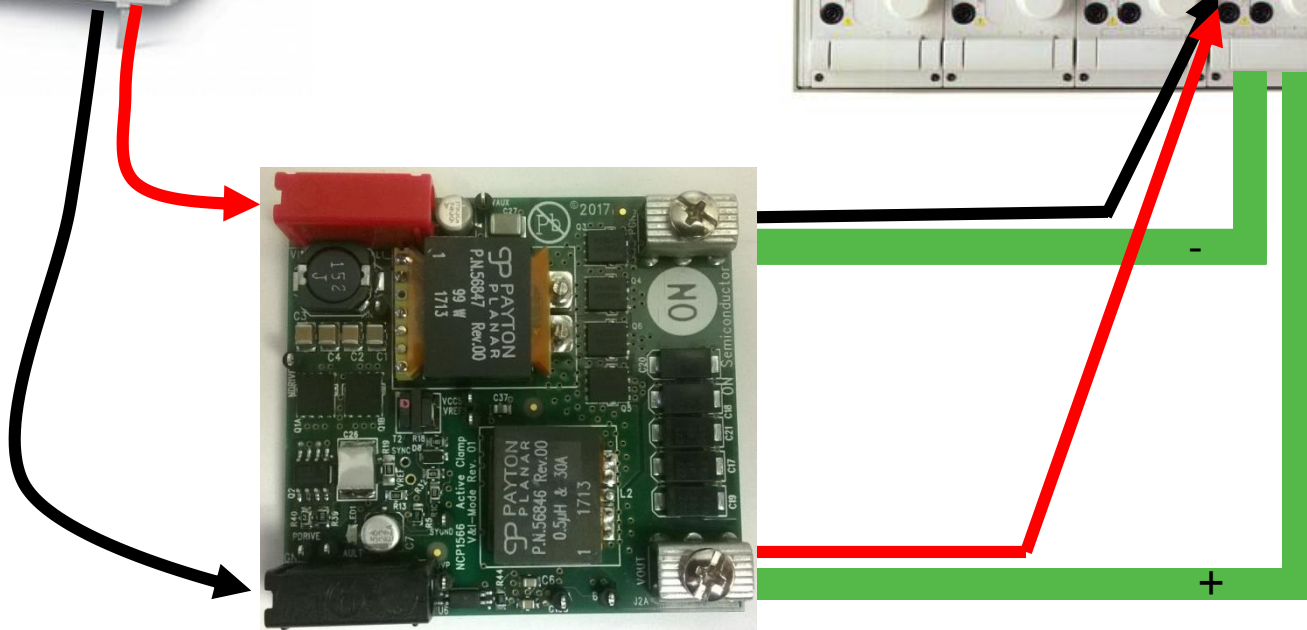
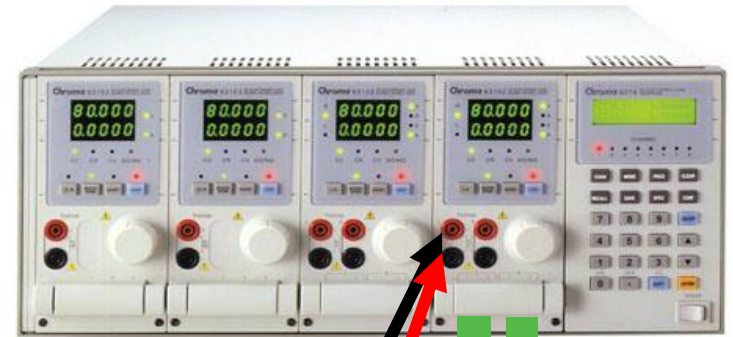

- Leave the board for 5 mn at  $V_{in} = 36 \text{ V}/30 \text{ A}$ .
- Check no thermal tripping occurs.
- Board is declared sound.

# Demonstration Board Schematic

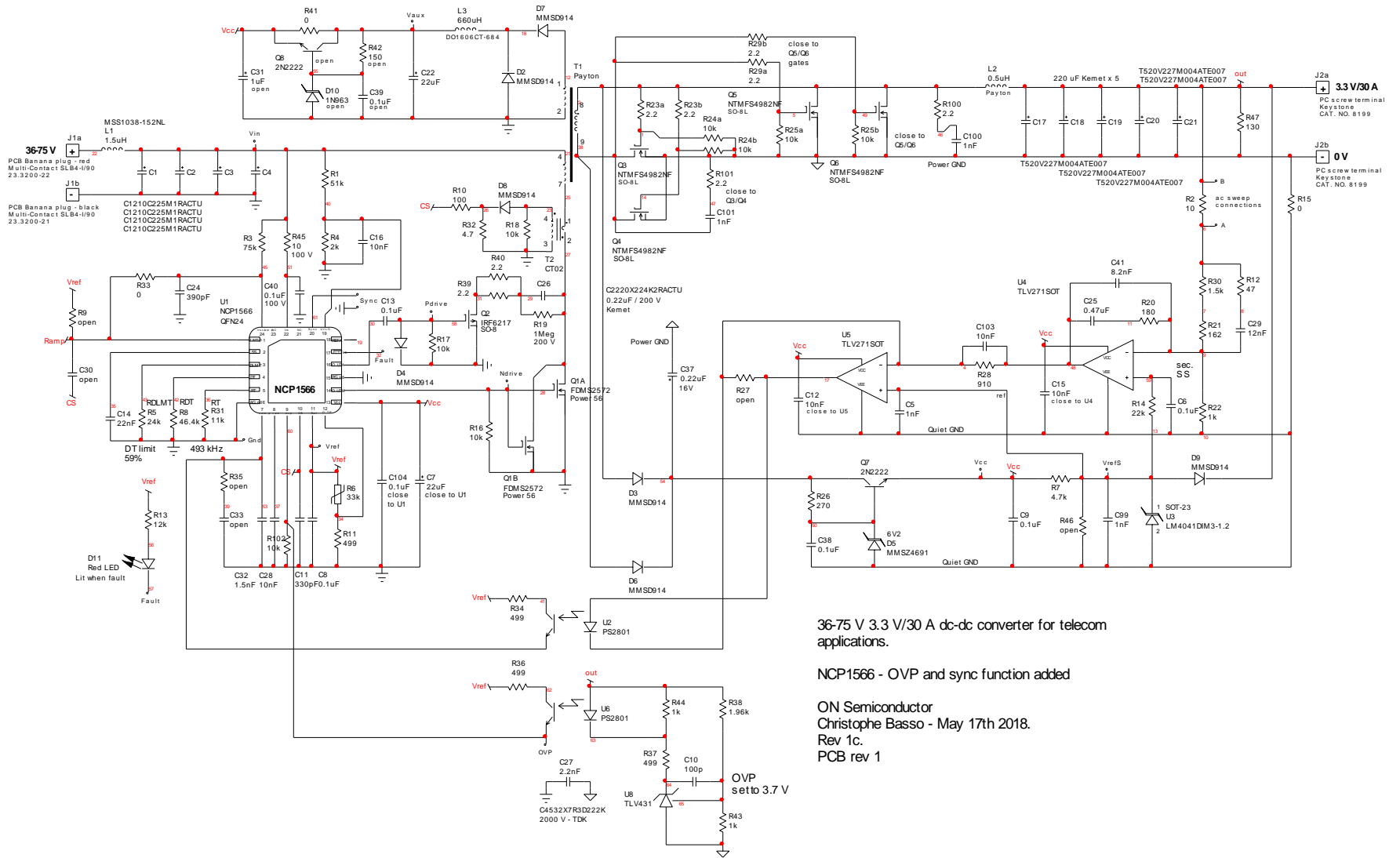

36-75 V 3.3 V/30 A dc-dc converter for telecom applications.

NCP1566 - OVP and sync function added

ON Semiconductor  
 Christophe Basso - May 17th 2018.  
 Rev 1c.  
 PCB rev 1

