

Bridgelux® Gen 7 Vero® 29 Array

Product Data Sheet DS93



Introduction

Vero® Series

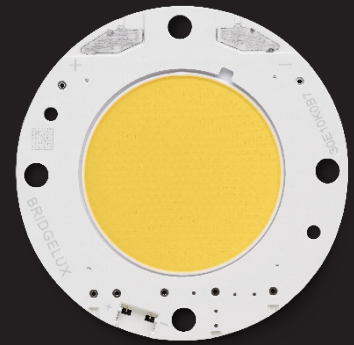

Vero® Series is a revolutionary advancement in chip on board (COB) light source technology and innovation. Vero LED light sources simplify luminaire design and manufacturing processes. Vero Chip on Board (COB) LED arrays are available in four LES configurations, engineered to enable new degrees of flexibility and reliability over a broad range of electrical currents. Vero arrays deliver increased lumen density to enable improved beam control and precision lighting with 2 and 3 SDCM color control standard for clean and consistent uniform lighting.

Vero products include an onboard connector port that enables a solder-free electrical interconnect, and simple mounting features for plug-and-play installation.

Bridgelux Décor Series™ is our state-of-the-art color line designed specifically for premium applications, producing unmatched LED light quality with brilliant color-rendering options and pleasing lighting palettes. Bridgelux Décor Series color points are available on Vero® SE Series, Vero® Series, V Series™ and V Series™ HD.

Décor Series™ Class A is based on human response testing, providing color points with a combined GAI and CRI metric.

Décor Series™ Ultra products provide a high CRI of 97 and typical R9 value of 98, which emphasizes the reds and color tones to which the human eye is most receptive - perfect for the most luxurious retail shops and world renowned museums. Décor Series Ultra is designed as a replacement for halogen lamps.

Décor Series™ Food products offer color points developed to address the unique requirements of the food, grocery, and restaurant industries. Highlighting the distinctive colors and nuanced patterns found in meats and breads, the Décor Series Food products are a must have for any butcher counter or bakery.

Décor Series™ Entertainment products provide color points developed specifically for the healthcare and entertainment industries. The 5600K cool white color point combined with a CRI of 90 or 97 provides the bright white required by these industries.

Décor Series™ Street and Landmark is designed to be a direct replacement for high pressure sodium lamps.

Features

- Efficacy of 160 lm/W typical
- Lumen output performance ranges from 3,850 to 38,400 lumens
- Broad range of CCT options from 1750K to 6500K
- CRI options include minimum 65, 70, 80, and 90, 2 and 3 SDCM color control for 2700K-4000K CCT
- Reliable operation at up to 2X nominal drive current
- Radial die pattern and improved lumen density
- Thermally isolated solder pads
- Onboard connector port
- Top side part number markings
- V_f bin code backside marking

Benefits

- Broad application coverage for interior and exterior lighting
- Flexibility for application driven lighting design requirements
- High quality true color reproduction
- Uniform consistent white light
- Flexibility in design optimization
- Enhanced ease of use and assembly
- Solderless connectivity enables plug & play installation and field upgradability
- Improved inventory management and quality control



Contents

Product Feature Map	2
Product Nomenclature	2
Product Selection Guide	3
Performance at Commonly Used Drive Currents	8
Electrical Characteristics	16
Eye Safety	17
Absolute Maximum Ratings	18
Performance Curves	19
Typical Radiation Pattern	23
Typical Color Spectrum	24
Mechanical Dimensions	25
Color Binning Information	26
Packaging and Labeling	27
Design Resources	29
Precautions	29
Disclaimers	29
About Bridgelux	30

Product Selection Guide

The following product configurations are available:

Table 1: Selection Guide, Pulsed Measurement Data ($T_j = T_c = 25^\circ\text{C}$)

Part Number	Nominal CCT ¹ (K)	CRI ²	Nominal Drive Current ³ (mA)	Typical Pulsed Flux ^{4,5,6} $T_c = 25^\circ\text{C}$ (lm)	Minimum Pulsed Flux ^{6,7} $T_c = 25^\circ\text{C}$ (lm)	Typical V_f (V)	Typical Power (W)	Typical Efficacy (lm/W)
BXRC-17E10K0-B-74	1750	80	1800	8291	7462	52.0	93.6	89
BXRC-17E10K0-C-74	1750	80	1710	10512	9461	69.4	118.7	89
BXRC-17E10K0-D-74	1750	80	2100	6994	6295	37.6	79.0	89
BXRC-20B10K1-C-73	2000	65	1710	17724	15952	69.4	118.7	149
BXRC-20B10K1-D-73	2000	65	2100	11793	10613	37.6	79.0	149
BXRC-25E10K0-B-74	2500	80	1800	13401	12061	52.0	93.6	143
BXRC-25E10K0-C-74	2500	80	1710	16991	15292	69.4	118.7	143
BXRC-25E10K0-D-74	2500	80	2100	11305	10174	37.6	79.0	143
BXRC-27E10K0-B-7X	2700	80	1800	14365	12928	52.0	93.6	153
BXRC-27E10K0-C-7X	2700	80	1710	18213	16392	69.4	118.7	153
BXRC-27E10K0-D-7X	2700	80	2100	12118	10906	37.6	79.0	153
BXRC-27G10K0-B-7X	2700	90	1800	11955	10759	52.0	93.6	128
BXRC-27G10K0-C-7X	2700	90	1710	15157	13641	69.4	118.7	128
BXRC-27G10K0-D-7X	2700	90	2100	10085	9076	37.6	79.0	128
BXRC-27H10K0-D-74	2700	97	2100	8788	7909	37.6	79.0	111
BXRC-30E10K0-B-7X ¹⁰	3000	80	1800	14943	13449	52.0	93.6	160
BXRC-30E10K0-C-7X ¹⁰	3000	80	1710	18946	17052	69.4	118.7	160
BXRC-30E10K0-D-7X ¹⁰	3000	80	2100	12606	11345	37.6	79.0	160
BXRC-30G10K0-B-7X	3000	90	1800	12437	11193	52.0	93.6	133
BXRC-30G10K0-C-7X	3000	90	1710	15768	14191	69.4	118.7	133
BXRC-30G10K0-D-7X	3000	90	2100	10491	9442	37.6	79.0	133
BXRC-30H10K0-D-7X	3000	97	2100	9353	8418	37.6	79.0	118
BXRC-30A10K1-B-73 ^{8,9}	3000	93	1800	11232	10109	52.0	93.6	120
BXRC-30A10K1-C-73 ^{8,9}	3000	93	1710	14241	12817	69.4	118.7	120
BXRC-30A10K1-D-73 ^{8,9}	3000	93	2100	9475	8528	37.6	79.0	120
BXRC-35E10K0-B-7X ¹⁰	3500	80	1800	15425	13883	52.0	93.6	165
BXRC-35E10K0-C-7X ¹⁰	3500	80	1710	19557	17602	69.4	118.7	165
BXRC-35E10K0-D-7X ¹⁰	3500	80	2100	13013	11711	37.6	79.0	165
BXRC-35G10K0-B-7X	3500	90	1800	12822	11540	52.0	93.6	137
BXRC-35G10K0-C-7X	3500	90	1710	16257	14631	69.4	118.7	137
BXRC-35G10K0-D-7X	3500	90	2100	10817	9735	37.6	79.0	137
BXRC-35A10K1-B-73 ^{8,9}	3500	93	1800	12074	10867	52.0	93.6	129
BXRC-35A10K1-C-73 ^{8,9}	3500	93	1710	15309	13778	69.4	118.7	129
BXRC-35A10K1-D-73 ^{8,9}	3500	93	2100	10186	9167	37.6	79.0	129

Notes for Table 1:

- Nominal CCT as defined by ANSI C78.377-2011. Products with a CCT of 5000K-6500K are hot targeted to $T_c = 85^\circ\text{C}$.
- CRI values are typical for Décor Series Class A and Décor Series Ultra products. CRI values are minimums for all other products. Minimum R_g value for 80 CRI products is 0, the minimum R_g values for 90 CRI products is 50, the minimum R_g values for 97 CRI products is 93. Bridgelux maintains a ±3 tolerance on CRI and R_g values.
- Drive current is referred to as nominal drive current.
- Products tested under pulsed condition (10ms pulse width) at nominal test current where T_j (junction temperature) = T_c (case temperature) = 25°C .
- Typical performance values are provided as a reference only and are not a guarantee of performance.
- Bridgelux maintains a ±7% tolerance on flux measurements.
- Minimum flux values at the nominal test current are guaranteed by 100% test.
- Nominal CCT is defined by the Lighting Research Center's Class A definition. The center of the Class A color bin is on the corresponding isothermal line.
- GAI value is 80. To help ensure optimal fixture level performance, GAI is measured at the fixture level, on axis, at a case temperature of 70°C . GAI may vary depending on fixture design and performance.
- SKUs can meet DLC premium (Outdoor Mid Output) requirements under certain system level conditions.

Product Selection Guide

Table 1: Selection Guide, Pulsed Measurement Data ($T_j = T_c = 25^\circ\text{C}$) (continued)

Part Number	Nominal CCT ¹ (K)	CRI ²	Nominal Drive Current ³ (mA)	Typical Pulsed Flux ^{4,5,6} $T_c = 25^\circ\text{C}$ (lm)	Minimum Pulsed Flux ^{6,7} $T_c = 25^\circ\text{C}$ (lm)	Typical V_f (V)	Typical Power (W)	Typical Efficacy (lm/W)
BXRC-40E10K0-B-7X ¹⁰	4000	80	1800	15522	13970	52.0	93.6	166
BXRC-40E10K0-C-7X ¹⁰	4000	80	1710	19680	17712	69.4	118.7	166
BXRC-40E10K0-D-7X ¹⁰	4000	80	2100	13094	11785	37.6	79.0	166
BXRC-40G10K0-B-7X	4000	90	1800	13304	11974	52.0	93.6	142
BXRC-40G10K0-C-7X	4000	90	1710	16868	15181	69.4	118.7	142
BXRC-40G10K0-D-7X	4000	90	2100	11223	10101	37.6	79.0	142
BXRC-40H10K0-D-7X	4000	97	2100	9633	8670	37.6	79.0	122
BXRC-40A10K1-B-73 ^{8,9}	4000	93	1800	12917	11625	52.0	93.6	138
BXRC-40A10K1-C-73 ^{8,9}	4000	93	1710	16377	14739	69.4	118.7	138
BXRC-40A10K1-D-73 ^{8,9}	4000	93	2100	10896	9807	37.6	79.0	138
BXRC-50C10K1-B-7X ¹⁰	5000	70	1800	17064	15358	52.0	93.6	182
BXRC-50C10K1-C-7X ¹⁰	5000	70	1710	21635	19472	69.4	118.7	182
BXRC-50C10K1-D-7X ¹⁰	5000	70	2100	14395	12956	37.6	79.0	182
BXRC-50E10K1-B-7X ¹⁰	5000	80	1800	16004	14403	52.0	93.6	171
BXRC-50E10K1-C-7X ¹⁰	5000	80	1710	20291	18262	69.4	118.7	171
BXRC-50E10K1-D-7X ¹⁰	5000	80	2100	13501	12151	37.6	79.0	171
BXRC-50G10K1-B-7X	5000	90	1800	13594	12234	52.0	93.6	145
BXRC-50G10K1-C-7X	5000	90	1710	17235	15512	69.4	118.7	145
BXRC-50G10K1-D-7X	5000	90	2100	11467	10321	37.6	79.0	145
BXRC-56G10K0-B-74	5600	90	1800	14268	12842	52.0	93.6	152
BXRC-56G10K0-C-74	5600	90	1710	18091	16282	69.4	118.7	152
BXRC-56G10Kx-D-74	5600	90	2100	12037	10833	37.6	79.0	152
BXRC-56H10K0-D-74	5600	97	2100	10410	9369	37.6	79.0	132
BXRC-57C10K1-B-7X ¹⁰	5700	70	1800	16486	14837	52.0	93.6	176
BXRC-57C10K1-C-7X ¹⁰	5700	70	1710	20902	18812	69.4	118.7	176
BXRC-57C10K1-D-7X ¹⁰	5700	70	2100	13907	12517	37.6	79.0	176
BXRC-57E10K1-B-7X ¹⁰	5700	80	1800	15818	14237	52.0	93.6	169
BXRC-57E10K1-C-7X ¹⁰	5700	80	1710	20056	18050	69.4	118.7	169
BXRC-57E10K1-D-7X ¹⁰	5700	80	2100	13344	12010	37.6	79.0	169
BXRC-65C10K1-B-7X ¹⁰	6500	70	1800	16775	15097	52.0	93.6	179
BXRC-65C10K1-C-7X ¹⁰	6500	70	1710	21269	19142	69.4	118.7	179
BXRC-65C10K1-D-7X ¹⁰	6500	70	2100	14151	12736	37.6	79.0	179
BXRC-65E10K1-B-7X ¹⁰	6500	80	1800	16099	14489	52.0	93.6	172
BXRC-65E10K1-C-7X ¹⁰	6500	80	1710	20412	18371	69.4	118.7	172
BXRC-65E10K1-D-7X ¹⁰	6500	80	2100	13581	12223	37.6	79.0	172

Notes for Table 1:

- Nominal CCT as defined by ANSI C78.377-2011. Products with a CCT of 5000K-6500K are hot targeted to $T_c = 85^\circ\text{C}$.
- CRI values are typical for Décor Series Class A and Décor Series Ultra products. CRI values are minimums for all other products. Minimum Rg value for 80 CRI products is 0, the minimum Rg values for 90 CRI products is 50, the minimum Rg value for 97 CRI products is 93. Bridgelux maintains a ± 3 tolerance on CRI and Rg values.
- Drive current is referred to as nominal drive current.
- Products tested under pulsed condition (10ms pulse width) at nominal test current where T_j (junction temperature) - T_c (case temperature) = 25°C .
- Typical performance values are provided as a reference only and are not a guarantee of performance.
- Bridgelux maintains a $\pm 7\%$ tolerance on flux measurements.
- Minimum flux values at the nominal test current are guaranteed by 100% test.
- Nominal CCT is defined by the Lighting Research Center's Class A definition. The center of the Class A color bin is on the corresponding isothermal line.
- GAI value is 80. To help ensure optimal fixture level performance, GAI is measured at the fixture level, on axis, at a case temperature of 70°C . GAI may vary depending on fixture design and performance.
- SKUs can meet DLC premium (Outdoor Mid Output) requirements under certain system level conditions.

Product Selection Guide

Table 2: Selection Guide, Stabilized DC Performance ($T_c = 70^\circ\text{C}$) ^{7,8}

Part Number	Nominal CCT ¹ (K)	GAI ²	CRI ³	Nominal Drive Current ⁴ (mA)	Typical DC Flux ^{5,6} $T_c = 70^\circ\text{C}$ (lm)	Minimum DC Flux ^{6,9} $T_c = 70^\circ\text{C}$ (lm)	Typical V_f (V)	Typical Power (W)	Typical Efficacy (lm/W)
BXRC-30A10K1-B-73	3000	80	93	1800	10446	9401	50.9	91.6	114
BXRC-30A10K1-C-73	3000	80	93	1710	13244	11920	67.9	116.1	114
BXRC-30A10K1-D-73	3000	80	93	2100	8812	7931	36.8	77.3	114
BXRC-35A10K1-B-73	3500	80	93	1800	11229	10106	50.9	91.6	123
BXRC-35A10K1-C-73	3500	80	93	1710	14237	12814	67.9	116.1	123
BXRC-35A10K1-D-73	3500	80	93	2100	9473	8526	36.8	77.3	122
BXRC-40A10K1-B-73	4000	80	93	1800	12013	10811	50.9	91.6	131
BXRC-40A10K1-C-73	4000	80	93	1710	15231	13708	67.9	116.1	131
BXRC-40A10K1-D-73	4000	80	93	2100	10134	9120	36.8	77.3	131

Notes for Table 2:

1. Nominal CCT is defined by the Lighting Research Center's Class A definition. The center of the Class A color bin is on the corresponding isothermal line.
2. To help ensure optimal fixture level performance, GAI is measured at the fixture level, on axis, at a case temperature of 70°C . GAI may vary depending on fixture design and performance.
3. CRI Values are specified as typical.
4. Drive current is referred to as nominal drive current.
5. Typical performance values are provided as a reference only and are not a guarantee of performance.
6. Bridgelux maintains a $\pm 7\%$ tolerance on flux measurements.
7. Typical stabilized DC performance values are provided as reference only and are not a guarantee of performance.
8. Typical performance is estimated based on operation under DC (direct current) with LED array mounted onto a heat sink with thermal interface material and the case temperature maintained at specified temperature. Based on Bridgelux test setup, values may vary depending on the thermal design of the luminaire and/or the exposed environment to which the product is subjected.
9. Minimum flux values at elevated temperatures are provided for reference only and are not guaranteed by 100% production testing. Based on Bridgelux test setup, values may vary depending on the thermal design of the luminaire and/or the exposed environment to which the product is subjected.

Product Selection Guide

Table 3: Selection Guide, Stabilized DC Performance ($T_c = 85^\circ\text{C}$)^{4,5}

Part Number	Nominal CCT ¹ (K)	CRI ²	Nominal Drive Current ³ (mA)	Typical DC Flux ^{4,5} $T_c = 85^\circ\text{C}$ (lm)	Minimum DC Flux ⁶ $T_c = 85^\circ\text{C}$ (lm)	Typical V_f (V)	Typical Power (W)	Typical Efficacy (lm/W)
BXRC-17E10K0-B-74	1750	80	1800	7462	6716	50.7	91.2	82
BXRC-17E10K0-C-74	1750	80	1710	9461	8515	68.1	116.4	81
BXRC-17E10K0-D-74	1750	80	2100	6295	5665	36.6	76.8	82
BXRC-20B10K1-C-73	2000	65	1710	15952	14356	68.1	116.4	137
BXRC-20B10K1-D-73	2000	65	2100	10613	9552	36.6	76.8	138
BXRC-25E10K0-B-74	2500	80	1800	12061	10855	50.7	91.2	132
BXRC-25E10K0-C-74	2500	80	1710	15292	13762	68.1	116.4	131
BXRC-25E10K0-D-74	2500	80	2100	10174	9157	36.6	76.8	133
BXRC-27E10K0-B-7X	2700	80	1800	12928	11635	50.7	91.2	142
BXRC-27E10K0-C-7X	2700	80	1710	16392	14752	68.1	116.4	141
BXRC-27E10K0-D-7X	2700	80	2100	10906	9816	36.6	76.8	142
BXRC-27G10K0-B-7X	2700	90	1800	10759	9683	50.7	91.2	118
BXRC-27G10K0-C-7X	2700	90	1710	13641	12277	68.1	116.4	117
BXRC-27G10K0-D-7X	2700	90	2100	9076	8169	36.6	76.8	118
BXRC-27H10K0-D-74	2700	97	2100	7909	7118	36.6	76.8	103
BXRC-30E10K0-B-7X	3000	80	1800	13449	12104	50.7	91.2	147
BXRC-30E10K0-C-7X	3000	80	1710	17052	15347	68.1	116.4	146
BXRC-30E10K0-D-7X	3000	80	2100	11345	10211	36.6	76.8	148
BXRC-30G10K0-B-7X	3000	90	1800	11193	10074	50.7	91.2	123
BXRC-30G10K0-C-7X	3000	90	1710	14191	12772	68.1	116.4	122
BXRC-30G10K0-D-7X	3000	90	2100	9442	8498	36.6	76.8	123
BXRC-30H10K0-D-7X	3000	97	2100	8418	7576	36.6	76.8	110
BXRC-30A10K1-B-73 ^{7,8}	3000	93	1800	10109	9098	50.7	91.2	111
BXRC-30A10K1-C-73 ^{7,8}	3000	93	1710	12817	11535	68.1	116.4	110
BXRC-30A10K1-D-73 ^{7,8}	3000	93	2100	8528	7675	36.6	76.8	111
BXRC-35E10K0-B-7X	3500	80	1800	13883	12494	50.7	91.2	152
BXRC-35E10K0-C-7X	3500	80	1710	17602	15842	68.1	116.4	151
BXRC-35E10K0-D-7X	3500	80	2100	11711	10540	36.6	76.8	153
BXRC-35G10K0-B-7X	3500	90	1800	11540	10386	50.7	91.2	127
BXRC-35G10K0-C-7X	3500	90	1710	14631	13168	68.1	116.4	126
BXRC-35G10K0-D-7X	3500	90	2100	9735	8762	36.6	76.8	127
BXRC-35A10K1-B-73 ^{7,8}	3500	93	1800	10867	9780	50.7	91.2	119
BXRC-35A10K1-C-73 ^{7,8}	3500	93	1710	13778	12400	68.1	116.4	118
BXRC-35A10K1-D-73 ^{7,8}	3500	93	2100	9167	8251	36.6	76.8	119

Notes for Table 3:

- Nominal CCT as defined by ANSI C78.377-2011. Products with a CCT of 5000K-6500K are hot targeted to $T_c = 85^\circ\text{C}$.
- All CRI values are measured at $T_c = T_a = 25^\circ\text{C}$. CRI values are typical for Décor Series Class A and Décor Series Ultra products. CRI values are minimums for all other products. Minimum Rg value for 80 CRI products is 0, the minimum Rg values for 90 CRI products is 50, the minimum Rg values for 97 CRI products is 93. Bridgelux maintains a ± 3 tolerance on CRI and Rg values.
- Drive current is referred to as nominal drive current.
- Typical stabilized DC performance values are provided as reference only and are not a guarantee of performance.
- Typical performance is estimated based on operation under DC (direct current) with LED array mounted onto a heat sink with thermal interface material and the case temperature maintained at 85°C . Based on Bridgelux test setup, values may vary depending on the thermal design of the luminaire and/or the exposed environment to which the product is subjected.
- Minimum flux values at elevated temperatures are provided for reference only and are not guaranteed by 100% production testing. Based on Bridgelux test setup, values may vary depending on the thermal design of the luminaire and/or the exposed environment to which the product is subjected.
- Nominal CCT is defined by the Lighting Research Center's Class A definition. The center of the Class A color bin is on the corresponding isothermal line.
- GAI value is 80. To help ensure optimal fixture level performance, GAI is measured at the fixture level, on axis, at a case temperature of 70°C . GAI may vary depending on fixture design and performance.

Product Selection Guide

Table 3: Selection Guide, Stabilized DC Performance ($T_c = 85^\circ\text{C}$)^{4,5} (continued)

Part Number	Nominal CCT ¹ (K)	CRI ²	Nominal Drive Current ³ (mA)	Typical DC Flux ^{4,5} $T_c = 85^\circ\text{C}$ (lm)	Minimum DC Flux ⁶ $T_c = 85^\circ\text{C}$ (lm)	Typical V_f (V)	Typical Power (W)	Typical Efficacy (lm/W)
BXRC-40E10K0-B-7X	4000	80	1800	13970	12573	50.7	91.2	153
BXRC-40E10K0-C-7X	4000	80	1710	17712	15941	68.1	116.4	152
BXRC-40E10K0-D-7X	4000	80	2100	11785	10606	36.6	76.8	154
BXRC-40G10K0-B-7X	4000	90	1800	11974	10776	50.7	91.2	131
BXRC-40G10K0-C-7X	4000	90	1710	15181	13663	68.1	116.4	130
BXRC-40G10K0-D-7X	4000	90	2100	10101	9091	36.6	76.8	132
BXRC-40H10K0-D-7X	4000	97	2100	8670	7803	36.6	76.8	113
BXRC-40A10K1-B-73 ^{7,8}	4000	93	1800	11625	10463	50.7	91.2	127
BXRC-40A10K1-C-73 ^{7,8}	4000	93	1710	14739	13265	68.1	116.4	127
BXRC-40A10K1-D-73 ^{7,8}	4000	93	2100	9807	8826	36.6	76.8	128
BXRC-50C10K1-B-7X	5000	70	1800	15358	13822	50.7	91.2	168
BXRC-50C10K1-C-7X	5000	70	1710	19472	17525	68.1	116.4	167
BXRC-50C10K1-D-7X	5000	70	2100	12956	11660	36.6	76.8	169
BXRC-50E10K1-B-7X	5000	80	1800	14403	12963	50.7	91.2	158
BXRC-50E10K1-C-7X	5000	80	1710	18262	16436	68.1	116.4	157
BXRC-50E10K1-D-7X	5000	80	2100	12151	10935	36.6	76.8	158
BXRC-50G10K1-B-7X	5000	90	1800	12234	11011	50.7	91.2	134
BXRC-50G10K1-C-7X	5000	90	1710	15512	13960	68.1	116.4	133
BXRC-50G10K1-D-7X	5000	90	2100	10321	9289	36.6	76.8	134
BXRC-56G10K0-B-74	5600	90	1800	12842	11557	50.7	91.2	141
BXRC-56G10K0-C-74	5600	90	1710	16282	14653	68.1	116.4	140
BXRC-56G10Kx-D-74	5600	90	2100	10833	9750	36.6	76.8	141
BXRC-56H10K0-D-74	5600	97	2100	9369	8432	36.6	76.8	122
BXRC-57C10K1-B-7X	5700	70	1800	14837	13353	50.7	91.2	163
BXRC-57C10K1-C-7X	5700	70	1710	18812	16931	68.1	116.4	162
BXRC-57C10K1-D-7X	5700	70	2100	12517	11265	36.6	76.8	163
BXRC-57E10K1-B-7X	5700	80	1800	14237	12813	50.7	91.2	156
BXRC-57E10K1-C-7X	5700	80	1710	18050	16245	68.1	116.4	155
BXRC-57E10K1-D-7X	5700	80	2100	12010	10809	36.6	76.8	156
BXRC-65C10K1-B-7X	6500	70	1800	15097	13588	50.7	91.2	166
BXRC-65C10K1-C-7X	6500	70	1710	19142	17228	68.1	116.4	164
BXRC-65C10K1-D-7X	6500	70	2100	12736	11462	36.6	76.8	166
BXRC-65E10K1-B-7X	6500	80	1800	14489	13040	50.7	91.2	159
BXRC-65E10K1-C-7X	6500	80	1710	18371	16534	68.1	116.4	158
BXRC-65E10K1-D-7X	6500	80	2100	12223	11001	36.6	76.8	159

Notes for Table 3:

- Nominal CCT as defined by ANSI C78.377-2011. Products with a CCT of 5000K-6500K are hot targeted to $T_c = 85^\circ\text{C}$.
- All CRI values are measured at $T_1 = T_c = 25^\circ\text{C}$. CRI values are typical for Decor Series Class A and Décor Series Ultra products. CRI values are minimums for all other products. Minimum Rg value for 80 CRI products is 0, the minimum Rg values for 90 CRI products is 50, the minimum Rg values for 97 CRI products is 93. Bridgelux maintains a ± 3 tolerance on CRI and Rg values.
- Drive current is referred to as nominal drive current.
- Typical stabilized DC performance values are provided as reference only and are not a guarantee of performance.
- Typical performance is estimated based on operation under DC (direct current) with LED array mounted onto a heat sink with thermal interface material and the case temperature maintained at 85°C . Based on Bridgelux test setup, values may vary depending on the thermal design of the luminaire and/or the exposed environment to which the product is subjected.
- Minimum flux values at elevated temperatures are provided for reference only and are not guaranteed by 100% production testing. Based on Bridgelux test setup, values may vary depending on the thermal design of the luminaire and/or the exposed environment to which the product is subjected.
- Nominal CCT is defined by the Lighting Research Center's Class A definition. The center of the Class A color bin is on the corresponding isothermal line.
- GAI value is 80. To help ensure optimal fixture level performance, GAI is measured at the fixture level, on axis, at a case temperature of 70°C . GAI may vary depending on fixture design and performance.

Performance at Commonly Used Drive Currents

Vero LED arrays are tested to the specifications shown using the nominal drive currents in Table 1. Vero may also be driven at other drive currents dependent on specific application design requirements. The performance at any drive current can be derived from the current vs. voltage characteristics shown in Figures 1, 2 & 3 and the flux vs. current characteristics shown in Figures 4, 5 & 6. The performance at commonly used drive currents is summarized in Table 4.

Table 4: Product Performance at Commonly Used Drive Currents

Part Number	CRI	Drive Current ¹ (mA)	Typical V_f $T_c = 25^\circ\text{C}$ (V)	Typical Power $T_c = 25^\circ\text{C}$ (W)	Typical Flux ² $T_c = 25^\circ\text{C}$ (lm)	Typical DC Flux ³ $T_c = 85^\circ\text{C}$ (lm)	Typical Efficacy $T_c = 25^\circ\text{C}$ (lm/W)
BXRC-17E10K0-B-74	80	900	49.6	44.7	4304	3929	96
		1200	50.5	60.6	5667	5152	94
		1800	52.0	93.6	8291	7462	89
		2700	54.1	146.1	11951	10659	82
		3600	55.8	201.0	15297	13477	76
BXRC-17E10K0-C-74	80	855	66.2	56.6	5972	5683	106
		1140	67.3	76.7	7590	7001	99
		1710	69.4	118.7	10512	9461	89
		2565	72.1	185.0	14913	12826	81
		3420	74.4	254.6	18692	15706	73
BXRC-17E10K0-D-74	80	1050	35.4	37.2	3847	3749	104
		1400	36.2	50.7	4951	4608	98
		2100	37.6	79.0	6994	6295	89
		3150	39.5	124.4	9957	8390	80
		4200	41.2	173.0	12550	10248	73
BXRC-20B10K1-C-73	65	855	66.2	56.6	10068	9581	178
		1140	67.3	76.7	12797	11804	167
		1710	69.4	118.7	17724	15952	149
		2565	72.1	185.0	25144	21625	136
		3420	74.4	254.6	31515	26482	124
BXRC-20B10K1-D-73	65	1050	35.4	37.2	6487	6320	175
		1400	36.2	50.7	8348	7769	165
		2100	37.6	79.0	11793	10613	149
		3150	39.5	124.4	16789	14146	135
		4200	41.2	173.0	21160	17279	122
BXRC-25E10K0-B-74	80	900	49.6	44.7	6957	6350	156
		1200	50.5	60.6	9160	8326	151
		1800	52.0	93.6	13401	12061	143
		2700	54.1	146.1	19317	17227	132
		3600	55.8	201.0	24724	21783	123
BXRC-25E10K0-C-74	80	855	66.2	56.6	9652	9185	171
		1140	67.3	76.7	12267	11316	160
		1710	69.4	118.7	16991	15292	143
		2565	72.1	185.0	24103	20731	130
		3420	74.4	254.6	30211	25386	119
BXRC-25E10K0-D-74	80	1050	35.4	37.2	6218	6059	167
		1400	36.2	50.7	8003	7448	158
		2100	37.6	79.0	11305	10174	143
		3150	39.5	124.4	16094	13561	129
		4200	41.2	173.0	20284	16564	117

Notes for Table 4:

1. Alternate drive currents are provided for reference only and are not a guarantee of performance.
2. Bridgelux maintains a $\pm 7\%$ tolerance on flux measurements.
3. Typical stabilized DC performance values are provided as reference only and are not a guarantee of performance.

Performance at Commonly Used Drive Currents

Table 4: Product Performance at Commonly Used Drive Currents (Continued)

Part Number	CRI	Drive Current ¹ (mA)	Typical V _f T _c = 25°C (V)	Typical Power T _c = 25°C (W)	Typical Flux ² T _c = 25°C (lm)	Typical DC Flux ³ T _c = 85°C (lm)	Typical Efficacy T _c = 25°C (lm/W)
BXRC-27E10Ko-B-7X	80	900	49.6	44.7	7457	6807	167
		1200	50.5	60.6	9819	8925	162
		1800	52.0	93.6	14365	12928	153
		2700	54.1	146.1	20707	18466	142
		3600	55.8	201.0	26502	23350	132
BXRC-27E10Ko-C-7X	80	855	66.2	56.6	10346	9845	183
		1140	67.3	76.7	13150	12130	171
		1710	69.4	118.7	18213	16392	153
		2565	72.1	185.0	25837	22222	140
		3420	74.4	254.6	32385	27212	127
BXRC-27E10Ko-D-7X	80	1050	35.4	37.2	6666	6495	179
		1400	36.2	50.6	8578	7983	169
		2100	37.6	79.0	12118	10906	153
		3150	39.5	124.4	17252	14536	139
		4200	41.2	172.9	21743	17755	126
BXRC-27G10Ko-B-7X	90	900	49.6	44.7	6206	5665	139
		1200	50.5	60.6	8171	7428	135
		1800	52.0	93.6	11955	10759	128
		2700	54.1	146.1	17232	15368	118
		3600	55.8	201.0	22056	19433	110
BXRC-27G10Ko-C-7X	90	855	66.2	56.6	8610	8193	152
		1140	67.3	76.7	10944	10095	143
		1710	69.4	118.7	15157	13641	128
		2565	72.1	185.0	21502	18493	116
		3420	74.4	254.6	26951	22646	106
BXRC-27G10Ko-D-7X	90	1050	35.4	37.2	5547	5405	149
		1400	36.2	50.6	7139	6644	141
		2100	37.6	79.0	10085	9076	128
		3150	39.5	124.4	14357	12097	115
		4200	41.2	172.9	18095	14776	105
BXRC-27H10Ko-D-74	97	1050	35.4	37.2	4834	4710	130
		1400	36.2	50.6	6221	5790	123
		2100	37.6	79.0	8788	7909	111
		3150	39.5	124.4	12511	10542	101
		4200	41.2	172.9	15768	12876	91
BXRC-30E10Ko-B-7X	80	900	49.6	44.7	7757	7081	174
		1200	50.5	60.6	10214	9285	169
		1800	52.0	93.6	14943	13449	160
		2700	54.1	146.1	21540	19210	147
		3600	55.8	201.0	27569	24291	137
BXRC-30E10Ko-C-7X	80	855	66.2	56.6	10763	10242	190
		1140	67.3	76.7	13679	12618	178
		1710	69.4	118.7	18946	17052	160
		2565	72.1	185.0	26878	23117	145
		3420	74.4	254.6	33689	28308	132

Notes for Table 4:

1. Alternate drive currents are provided for reference only and are not a guarantee of performance.
2. Bridgelux maintains a ± 7% tolerance on flux measurements.
3. Typical stabilized DC performance values are provided as reference only and are not a guarantee of performance.

Performance at Commonly Used Drive Currents

Table 4: Product Performance at Commonly Used Drive Currents (Continued)

Part Number	CRI	Drive Current ¹ (mA)	Typical V _f T _c = 25°C (V)	Typical Power T _c = 25°C (W)	Typical Flux ² T _c = 25°C (lm)	Typical DC Flux ³ T _c = 85°C (lm)	Typical Efficacy T _c = 25°C (lm/W)
BXRC-30E10Ko-D-7X	80	1050	35.4	37.2	6934	6756	186
		1400	36.2	50.6	8924	8305	176
		2100	37.6	79.0	12606	11345	160
		3150	39.5	124.4	17946	15121	144
		4200	41.2	172.9	22619	18470	131
BXRC-30G10Ko-B-7X	90	900	49.6	44.7	6456	5893	145
		1200	50.5	60.6	8501	7727	140
		1800	52.0	93.6	12437	11193	133
		2700	54.1	146.1	17927	15988	123
		3600	55.8	201.0	22945	20216	114
BXRC-30G10Ko-C-7X	90	855	66.2	56.6	8957	8524	158
		1140	67.3	76.7	11385	10502	148
		1710	69.4	118.7	15768	14191	133
		2565	72.1	185.0	22369	19239	121
		3420	74.4	254.6	28038	23559	110
BXRC-30G10Ko-D-7X	90	1050	35.4	37.2	5771	5623	155
		1400	36.2	50.6	7427	6912	147
		2100	37.6	79.0	10491	9442	133
		3150	39.5	124.4	14936	12585	120
		4200	41.2	172.9	18825	15372	109
BXRC-30H10Ko-D-7X	97	1050	35.4	37.2	5145	5013	138
		1400	36.2	50.6	6621	6162	131
		2100	37.6	79.0	9353	8418	118
		3150	39.5	124.4	13315	11219	107
		4200	41.2	172.9	16782	13704	97
BXRC-30A10K1-B-73	93	900	49.6	44.7	5831	5322	131
		1200	50.5	60.6	7678	6979	127
		1800	52.0	93.6	11232	10109	120
		2700	54.1	146.1	16191	14439	111
		3600	55.8	201.0	20722	18258	103
BXRC-30A10K1-C-73	93	855	66.2	56.6	8090	7698	143
		1140	67.3	76.7	10282	9485	134
		1710	69.4	118.7	14241	12817	120
		2565	72.1	185.0	20202	17376	109
		3420	74.4	254.6	25322	21277	99
BXRC-30A10K1-D-73	93	1050	35.4	37.2	5212	5078	140
		1400	36.2	50.6	6707	6242	132
		2100	37.6	79.0	9475	8528	120
		3150	39.5	124.4	13489	11366	108
		4200	41.2	172.9	17001	13883	98
BXRC-35E10Ko-B-7X	80	900	49.6	44.7	8008	7310	179
		1200	50.5	60.6	10544	9584	174
		1800	52.0	93.6	15425	13883	165
		2700	54.1	146.1	22235	19830	152
		3600	55.8	201.0	28459	25074	142

Notes for Table 4:

1. Alternate drive currents are provided for reference only and are not a guarantee of performance.
2. Bridgelux maintains a ± 7% tolerance on flux measurements.
3. Typical stabilized DC performance values are provided as reference only and are not a guarantee of performance.

Performance at Commonly Used Drive Currents

Table 4: Product Performance at Commonly Used Drive Currents (Continued)

Part Number	CRI	Drive Current ¹ (mA)	Typical V _f T _c = 25°C (V)	Typical Power T _c = 25°C (W)	Typical Flux ² T _c = 25°C (lm)	Typical DC Flux ³ T _c = 85°C (lm)	Typical Efficacy T _c = 25°C (lm/W)
BXRC-35E10Ko-C-7X	80	855	66.2	56.6	11110	10572	196
		1140	67.3	76.7	14121	13026	184
		1710	69.4	118.7	19557	17602	165
		2565	72.1	185.0	27745	23863	150
		3420	74.4	254.6	34775	29221	137
BXRC-35E10Ko-D-7X	80	1050	35.4	37.2	7158	6974	192
		1400	36.2	50.6	9212	8573	182
		2100	37.6	79.0	13013	11711	165
		3150	39.5	124.4	18525	15609	149
		4200	41.2	172.9	23349	19066	135
BXRC-35G10Ko-B-7X	90	900	49.6	44.7	6656	6076	149
		1200	50.5	60.6	8765	7967	145
		1800	52.0	93.6	12822	11540	137
		2700	54.1	146.1	18483	16484	127
		3600	55.8	201.0	23656	20843	118
BXRC-35G10Ko-C-7X	90	855	66.2	56.6	9235	8788	163
		1140	67.3	76.7	11738	10827	153
		1710	69.4	118.7	16257	14631	137
		2565	72.1	185.0	23063	19836	125
		3420	74.4	254.6	28907	24290	114
BXRC-35G10Ko-D-7X	90	1050	35.4	37.2	5950	5797	160
		1400	36.2	50.6	7657	7126	151
		2100	37.6	79.0	10817	9735	137
		3150	39.5	124.4	15399	12975	124
		4200	41.2	172.9	19408	15849	112
BXRC-35A10K1-B-73	93	900	49.6	44.7	6268	5722	140
		1200	50.5	60.6	8253	7502	136
		1800	52.0	93.6	12074	10867	129
		2700	54.1	146.1	17405	15522	119
		3600	55.8	201.0	22277	19627	111
BXRC-35A10K1-C-73	93	855	66.2	56.6	8697	8276	154
		1140	67.3	76.7	11053	10196	144
		1710	69.4	118.7	15309	13778	129
		2565	72.1	185.0	21718	18679	117
		3420	74.4	254.6	27221	22873	107
BXRC-35A10K1-D-73	93	1050	35.4	37.2	5603	5459	151
		1400	36.2	50.6	7211	6710	142
		2100	37.6	79.0	10186	9167	129
		3150	39.5	124.4	14501	12218	117
		4200	41.2	172.9	18276	14924	106
BXRC-40E10Ko-B-7X	80	900	49.6	44.7	8058	7355	180
		1200	50.5	60.6	10610	9644	175
		1800	52.0	93.6	15522	13970	166
		2700	54.1	146.1	22374	19954	153
		3600	55.8	201.0	28637	25231	142

Notes for Table 4:

1. Alternate drive currents are provided for reference only and are not a guarantee of performance.
2. Bridgelux maintains a ± 7% tolerance on flux measurements.
3. Typical stabilized DC performance values are provided as reference only and are not a guarantee of performance.

Performance at Commonly Used Drive Currents

Table 4: Product Performance at Commonly Used Drive Currents (Continued)

Part Number	CRI	Drive Current ¹ (mA)	Typical V _f T _c = 25°C (V)	Typical Power T _c = 25°C (W)	Typical Flux ² T _c = 25°C (lm)	Typical DC Flux ³ T _c = 85°C (lm)	Typical Efficacy T _c = 25°C (lm/W)
BXRC-40E10Ko-C-7X	80	855	66.2	56.6	11179	10638	198
		1140	67.3	76.7	14209	13107	185
		1710	69.4	118.7	19680	17712	166
		2565	72.1	185.0	27918	24012	151
		3420	74.4	254.6	34993	29404	137
BXRC-40E10Ko-D-7X	80	1050	35.4	37.2	7202	7018	194
		1400	36.2	50.6	9269	8626	183
		2100	37.6	79.0	13094	11785	166
		3150	39.5	124.4	18641	15707	150
		4200	41.2	172.9	23494	19185	136
BXRC-40G10Ko-B-7X	90	900	49.6	44.7	6907	6304	155
		1200	50.5	60.6	9094	8266	150
		1800	52.0	93.6	13304	11974	142
		2700	54.1	146.1	19178	17103	131
		3600	55.8	201.0	24546	21626	122
BXRC-40G10Ko-C-7X	90	855	66.2	56.6	9582	9118	169
		1140	67.3	76.7	12179	11235	159
		1710	69.4	118.7	16868	15181	142
		2565	72.1	185.0	23930	20581	129
		3420	74.4	254.6	29994	25203	118
BXRC-40G10Ko-D-7X	90	1050	35.4	37.2	6173	6015	166
		1400	36.2	50.6	7945	7394	157
		2100	37.6	79.0	11223	10101	142
		3150	39.5	124.4	15978	13463	128
		4200	41.2	172.9	20138	16444	116
BXRC-40H10Ko-D-7X	97	1050	35.4	37.2	5299	5163	142
		1400	36.2	50.6	6819	6346	135
		2100	37.6	79.0	9633	8670	122
		3150	39.5	124.4	13714	11555	110
		4200	41.2	172.9	17285	14114	100
BXRC-40A10K1-B-73	93	900	49.6	44.7	6705	6121	150
		1200	50.5	60.6	8829	8026	146
		1800	52.0	93.6	12917	11625	138
		2700	54.1	146.1	18619	16605	127
		3600	55.8	201.0	23831	20997	119
BXRC-40A10K1-C-73	93	855	66.2	56.6	9303	8853	164
		1140	67.3	76.7	11824	10907	154
		1710	69.4	118.7	16377	14739	138
		2565	72.1	185.0	23233	19982	126
		3420	74.4	254.6	29120	24469	114
BXRC-40A10K1-D-73	93	1050	35.4	37.2	5994	5840	161
		1400	36.2	50.6	7714	7179	152
		2100	37.6	79.0	10896	9807	138
		3150	39.5	124.4	15513	13071	125
		4200	41.2	172.9	19552	15966	113

Notes for Table 4:

1. Alternate drive currents are provided for reference only and are not a guarantee of performance.
2. Bridgelux maintains a ± 7% tolerance on flux measurements.
3. Typical stabilized DC performance values are provided as reference only and are not a guarantee of performance.

Performance at Commonly Used Drive Currents

Table 4: Product Performance at Commonly Used Drive Currents (Continued)

Part Number	CRI	Drive Current ¹ (mA)	Typical V _f T _c = 25°C (V)	Typical Power T _c = 25°C (W)	Typical Flux ² T _c = 25°C (lm)	Typical DC Flux ³ T _c = 85°C (lm)	Typical Efficacy T _c = 25°C (lm/W)
BXRC-50C10K1-B-7x	70	900	49.6	44.7	8858	8086	198
		1200	50.5	60.6	11664	10603	193
		1800	52.0	93.6	17064	15358	182
		2700	54.1	146.1	24598	21937	168
		3600	55.8	201.0	31482	27738	157
BXRC-50C10K1-C-7x	70	855	66.2	56.6	12290	11695	217
		1140	67.3	76.7	15621	14409	204
		1710	69.4	118.7	21635	19472	182
		2565	72.1	185.0	30693	26398	166
		3420	74.4	254.6	38470	32326	151
BXRC-50C10K1-D-7x	70	1050	35.4	37.2	7918	7715	213
		1400	36.2	50.6	10190	9484	201
		2100	37.6	79.0	14395	12956	182
		3150	39.5	124.4	20494	17268	165
		4200	41.2	172.9	25829	21092	149
BXRC-50E10K1-B-7x	80	900	49.6	44.7	8308	7584	186
		1200	50.5	60.6	10939	9944	181
		1800	52.0	93.6	16004	14403	171
		2700	54.1	146.1	23069	20573	158
		3600	55.8	201.0	29526	26014	147
BXRC-50E10K1-C-7x	80	855	66.2	56.6	11527	10969	204
		1140	67.3	76.7	14650	13514	191
		1710	69.4	118.7	20291	18262	171
		2565	72.1	185.0	28785	24757	156
		3420	74.4	254.6	36079	30317	142
BXRC-50E10K1-D-7x	80	1050	35.4	37.2	7426	7236	200
		1400	36.2	50.6	9557	8894	189
		2100	37.6	79.0	13501	12151	171
		3150	39.5	124.4	19220	16195	155
		4200	41.2	172.9	24224	19781	140
BXRC-50G10K1-B-7x	90	900	49.6	44.7	7057	6442	158
		1200	50.5	60.6	9292	8446	153
		1800	52.0	93.6	13594	12234	145
		2700	54.1	146.1	19595	17475	134
		3600	55.8	201.0	25079	22097	125
BXRC-50G10K1-C-7x	90	855	66.2	56.6	9791	9317	173
		1140	67.3	76.7	12444	11479	162
		1710	69.4	118.7	17235	15512	145
		2565	72.1	185.0	24450	21029	132
		3420	74.4	254.6	30646	25751	120
BXRC-50G10K1-D-7x	90	1050	35.4	37.2	6308	6146	170
		1400	36.2	50.6	8118	7555	160
		2100	37.6	79.0	11467	10321	145
		3150	39.5	124.4	16326	13756	131
		4200	41.2	172.9	20576	16802	119

Notes for Table 4:

1. Alternate drive currents are provided for reference only and are not a guarantee of performance.
2. Bridgelux maintains a ± 7% tolerance on flux measurements.
3. Typical stabilized DC performance values are provided as reference only and are not a guarantee of performance.

Performance at Commonly Used Drive Currents

Table 4: Product Performance at Commonly Used Drive Currents (Continued)

Part Number	CRI	Drive Current ¹ (mA)	Typical V _f T _c = 25°C (V)	Typical Power T _c = 25°C (W)	Typical Flux ² T _c = 25°C (lm)	Typical DC Flux ³ T _c = 85°C (lm)	Typical Efficacy T _c = 25°C (lm/W)
BXRC-56G10K0-B-7x	90	900	49.6	44.7	7407	6761	166
		1200	50.5	60.6	9753	8866	161
		1800	52.0	93.6	14268	12842	152
		2700	54.1	146.1	20568	18343	141
		3600	55.8	201.0	26324	23194	131
BXRC-56G10K0-C-7x	90	855	66.2	56.6	10277	9779	182
		1140	67.3	76.7	13062	12049	170
		1710	69.4	118.7	18091	16282	152
		2565	72.1	185.0	25664	22073	139
		3420	74.4	254.6	32167	27029	126
BXRC-56G10Kx-D-7x	90	1050	35.4	37.2	6621	6451	178
		1400	36.2	50.6	8521	7930	168
		2100	37.6	79.0	12037	10833	152
		3150	39.5	124.4	17136	14439	138
		4200	41.2	172.9	21597	17636	125
BXRC-56H10K0-D-74	97	1050	35.4	37.2	5726	5579	154
		1400	36.2	50.6	7369	6858	146
		2100	37.6	79.0	10410	9369	132
		3150	39.5	124.4	14820	12487	119
		4200	41.2	172.9	18679	15253	108
BXRC-57C10K1-B-7x	70	900	49.6	44.7	8558	7812	192
		1200	50.5	60.6	11269	10243	186
		1800	52.0	93.6	16486	14837	176
		2700	54.1	146.1	23764	21193	163
		3600	55.8	201.0	30415	26798	151
BXRC-57C10K1-C-7x	70	855	66.2	56.6	11874	11299	210
		1140	67.3	76.7	15092	13921	197
		1710	69.4	118.7	20902	18812	176
		2565	72.1	185.0	29652	25503	160
		3420	74.4	254.6	37166	31230	146
BXRC-57C10K1-D-7x	70	1050	35.4	37.2	7650	7454	206
		1400	36.2	50.6	9845	9162	194
		2100	37.6	79.0	13907	12517	176
		3150	39.5	124.4	19799	16682	159
		4200	41.2	172.9	24954	20377	144
BXRC-57E10K1-B-7x	80	900	49.6	44.7	8212	7496	184
		1200	50.5	60.6	10812	9829	179
		1800	52.0	93.6	15818	14237	169
		2700	54.1	146.1	22802	20335	156
		3600	55.8	201.0	29184	25713	145
BXRC-57E10K1-C-7x	80	855	66.2	56.6	11393	10842	201
		1140	67.3	76.7	14481	13357	189
		1710	69.4	118.7	20056	18050	169
		2565	72.1	185.0	28452	24471	154
		3420	74.4	254.6	35662	29966	140

Notes for Table 4:

1. Alternate drive currents are provided for reference only and are not a guarantee of performance.
2. Bridgelux maintains a ± 7% tolerance on flux measurements.
3. Typical stabilized DC performance values are provided as reference only and are not a guarantee of performance.

Performance at Commonly Used Drive Currents

Table 4: Product Performance at Commonly Used Drive Currents (Continued)

Part Number	CRI	Drive Current ¹ (mA)	Typical V _f T _c = 25°C (V)	Typical Power T _c = 25°C (W)	Typical Flux ² T _c = 25°C (lm)	Typical DC Flux ³ T _c = 85°C (lm)	Typical Efficacy T _c = 25°C (lm/W)
BXRC-57E10K1-D-7x	80	1050	35.4	37.2	7340	7152	197
		1400	36.2	50.6	9446	8791	187
		2100	37.6	79.0	13344	12010	169
		3150	39.5	124.4	18998	16007	153
		4200	41.2	172.9	23944	19552	138
BXRC-65C10K1-B-7x	70	900	49.6	44.7	8708	7949	195
		1200	50.5	60.6	11466	10423	189
		1800	52.0	93.6	16775	15097	179
		2700	54.1	146.1	24181	21565	166
		3600	55.8	201.0	30949	27268	154
BXRC-65C10K1-C-7x	70	855	66.2	56.6	12082	11497	214
		1140	67.3	76.7	15356	14165	200
		1710	69.4	118.7	21269	19142	179
		2565	72.1	185.0	30172	25951	163
		3420	74.4	254.6	37818	31778	149
BXRC-65C10K1-D-7x	70	1050	35.4	37.2	7784	7584	209
		1400	36.2	50.6	10018	9323	198
		2100	37.6	79.0	14151	12736	179
		3150	39.5	124.4	20146	16975	162
		4200	41.2	172.9	25392	20734	147
BXRC-65E10K1-B-7x	80	900	49.6	44.7	8357	7629	187
		1200	50.5	60.6	11004	10003	182
		1800	52.0	93.6	16099	14489	172
		2700	54.1	146.1	23207	20696	159
		3600	55.8	201.0	29702	26170	148
BXRC-65E10K1-C-7x	80	855	66.2	56.6	11595	11034	205
		1140	67.3	76.7	14738	13595	192
		1710	69.4	118.7	20412	18371	172
		2565	72.1	185.0	28957	24905	157
		3420	74.4	254.6	36295	30498	143
BXRC-65E10K1-D-7x	80	1050	35.4	37.2	7470	7279	201
		1400	36.2	50.6	9614	8947	190
		2100	37.6	79.0	13581	12223	172
		3150	39.5	124.4	19335	16291	155
		4200	41.2	172.9	24369	19899	141

Notes for Table 4:

1. Alternate drive currents are provided for reference only and are not a guarantee of performance.
2. Bridgelux maintains a ± 7% tolerance on flux measurements.
3. Typical stabilized DC performance values are provided as reference only and are not a guarantee of performance.

Electrical Characteristics

Table 5: Electrical Characteristics

Part Number	Drive Current (mA)	Forward Voltage Pulsed, $T_c = 25^\circ\text{C}$ (V) ^{1, 2, 3, 8}			Typical Coefficient of Forward Voltage ⁴ $\Delta V_f / \Delta T_c$ (mV/ $^\circ\text{C}$)	Typical Thermal Resistance Junction to Case ^{5,6} R_{j-c} ($^\circ\text{C}/\text{W}$)	Driver Selection Voltages ⁷ (V)	
		Minimum	Typical	Maximum			V_f Min. Hot $T_c = 105^\circ\text{C}$ (V)	V_f Max. Cold $T_c = -40^\circ\text{C}$ (V)
BXRC-xxx10Kx-B-7x	1800	48.1	52.0	55.9	-24.9	0.06	46.1	57.5
	3600	51.7	55.8	60.0	-24.9	0.07	49.7	61.6
BXRC-xxx10Kx-C-7x	1710	64.2	69.4	74.6	-33.2	0.04	61.5	76.8
	3420	68.8	74.4	80.0	-33.2	0.05	66.2	82.2
BXRC-xxx10Kx-D-7x	2100	34.8	37.6	40.4	-17.4	0.06	33.4	41.6
	4200	38.1	41.2	44.3	-17.4	0.07	36.7	45.4

Notes for Table 5:

- Parts are tested in pulsed conditions. $T_c = 25^\circ\text{C}$. Pulse width is 10ms.
- Voltage minimum and maximum are provided for reference only and are not a guarantee of performance.
- Bridgelux maintains a tester tolerance of $\pm 0.10\text{V}$ on forward voltage measurements.
- Typical coefficient of forward voltage tolerance is $\pm 0.1\text{mV}$ for nominal current.
- Thermal resistance values are based from test data of a 3000K 80 CRI product.
- Thermal resistance value was calculated using total electrical input power; optical power was not subtracted from input power. The thermal interface material used during testing is not included in the thermal resistance value.
- V_f min hot and max cold values are provided as reference only and are not guaranteed by test. These values are provided to aid in driver design and selection over the operating range of the product.
- This product has been designed and manufactured per IEC 62031:2014. This product has passed dielectric withstand voltage testing at 1160 V. The working voltage designated for the insulation is 80V d.c. The maximum allowable voltage across the array must be determined in the end product application.

Eye Safety

Table 6: Eye Safety Risk Group (RG) Classifications

Part Number	Drive Current ⁵ (mA)	CCT ⁵			
		2700K/3000K	4000K ²	5000K ³	6500K ⁴
BXRC-xxx10Kx-B-7x	1800	RG1	RG1	RG1	RG1
	2700	RG1	RG1	RG2	RG2
	3600	RG1	RG1	RG2	RG2
BXRC-xxx10Kx-C-7x	1710	RG1	RG1	RG1	RG2
	2565	RG1	RG1	RG2	RG2
	3420	RG1	RG2	RG2	RG2
BXRC-xxx10Kx-D-7x	2100	RG1	RG1	RG1	RG1
	3150	RG1	RG1	RG1	RG2
	4200	RG1	RG1	RG2	RG2

Notes for Table 6:

1. Eye safety classification for the use of Bridgelux Vero Series LED arrays is in accordance with specification IEC/TR 62778: Application of IEC 62471 for the assessment of blue light hazard to light sources and luminaires.
2. For products classified as RG2 at 4000K, $E_{thr} = 1847.5$ lx.
3. For products classified as RG2 at 5000K $E_{thr} = 1315.8$ lx.
4. For products classified as RG2 at 6500K, $E_{thr} = 1124.5$ lx.
5. Please contact your Bridgelux sales representative for E_{thr} values at specific drive currents and CCTs not listed

Absolute Maximum Ratings

Table 7: Maximum Ratings

Parameter	Maximum Rating		
LED Junction Temperature (T _j)	125°C		
Storage Temperature	-40°C to +105°C		
Operating Case Temperature ¹ (T _c)	105°C		
Soldering Temperature ²	300°C or lower for a maximum of 6 seconds		
	BXRC-xxx10Kx-B-7x	BXRC-xxx10Kx-C-7x	BXRC-xxx10Kx-D-7x
Maximum Drive Current ³	3600mA	3420mA	4200mA
Maximum Peak Pulsed Drive Current ^{4,5}	5140mA	4890mA	6000mA
Maximum Reverse Voltage ⁶	-90V	-120V	-65V

Notes for Table 7:

1. For IEC 62717 requirement, please consult your Bridgelux sales representative.
2. Refer to Bridgelux Application Note AN31: Assembly Considerations for Bridgelux Vero LED Arrays.
3. Arrays may be driven at higher currents however lumen maintenance may be reduced.
4. Per IEC 62031, LED Modules for General Lighting - Safety Specifications, the maximum allowable current when using the Molex Pico Connector is 3150mA.
5. Bridgelux recommends a maximum duty cycle of 10% and pulse width of 20 ms when operating LED Arrays at maximum peak pulsed current specified. Maximum peak pulsed currents indicate values where LED Arrays can be driven without catastrophic failures.
6. Light emitting diodes are not designed to be driven in reverse voltage and will not produce light under this condition. Maximum rating provided for reference only.

Performance Curves

Figure 1: Vero 29B Drive Current vs. Voltage

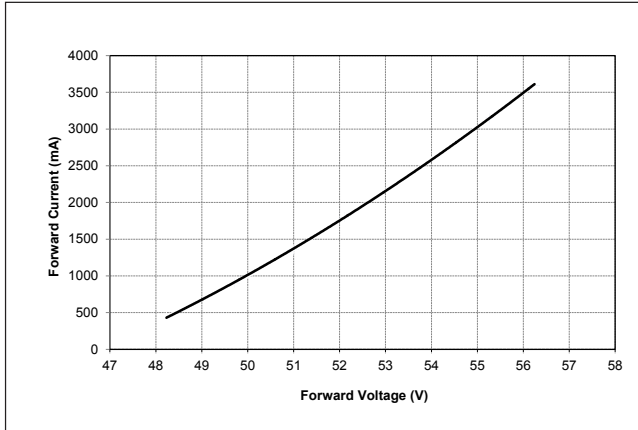

Figure 2: Vero 29C Drive Current vs. Voltage

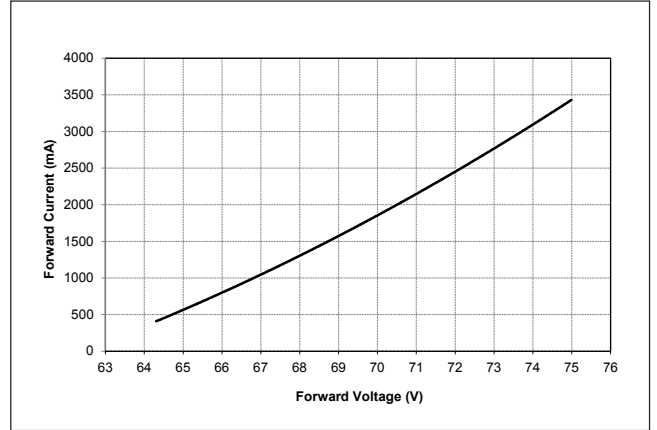

Figure 3: Vero 29D Drive Current vs. Voltage

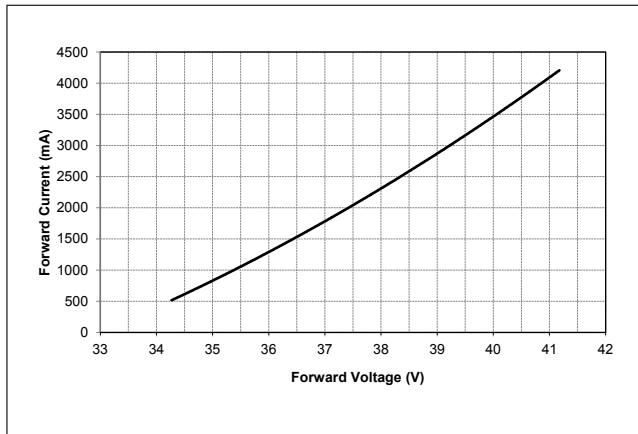

Figure 4: Vero 29B Typical Relative Flux vs. Current

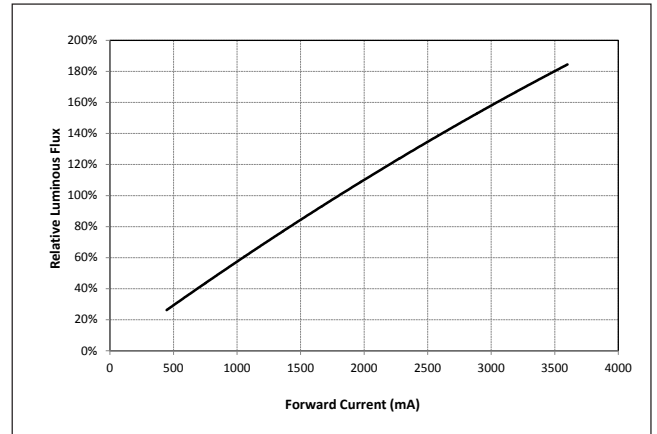

Figure 5: Vero 29C Typical Relative Flux vs. Current

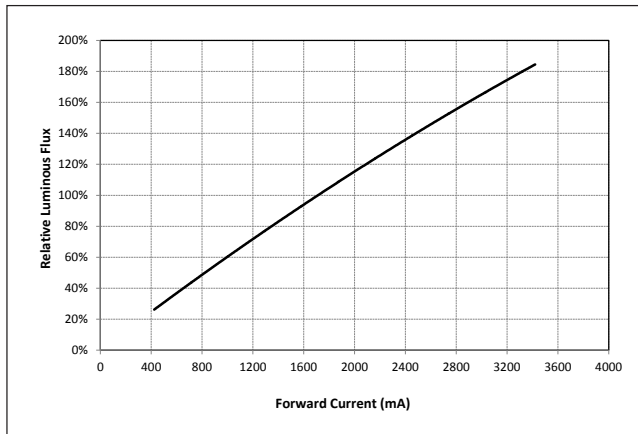
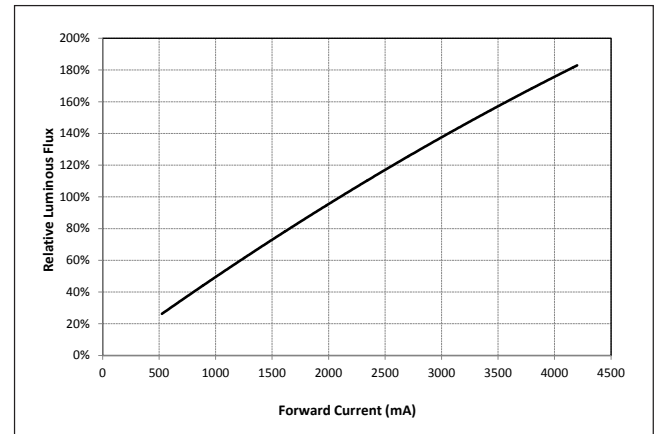

Figure 6: Vero 29D Typical Relative Flux vs. Current



Notes for Figures 1-6:

1. Bridgelux does not recommend driving high power LEDs at low currents. Doing so may produce unpredictable results. Pulse width modulation (PWM) is recommended for dimming effects.
2. Products tested under pulsed condition (10ms pulse width) at nominal test current where T_J (junction temperature) = T_C (case temperature) = 25°C.

Performance Curves

Figure 7: Typical DC Flux vs. Case Temperature

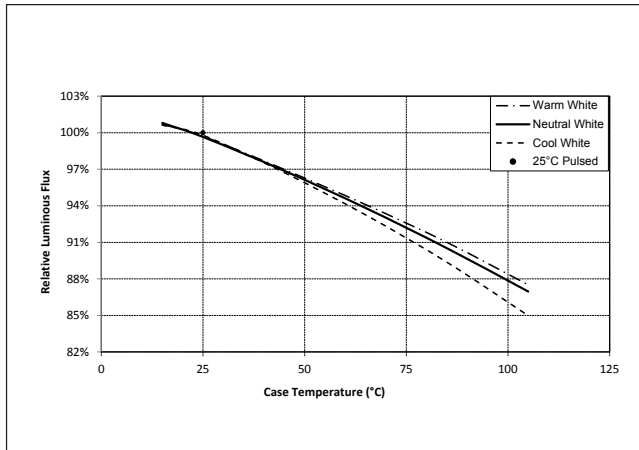

Figure 8: Typical DC ccy Shift vs. Case Temperature

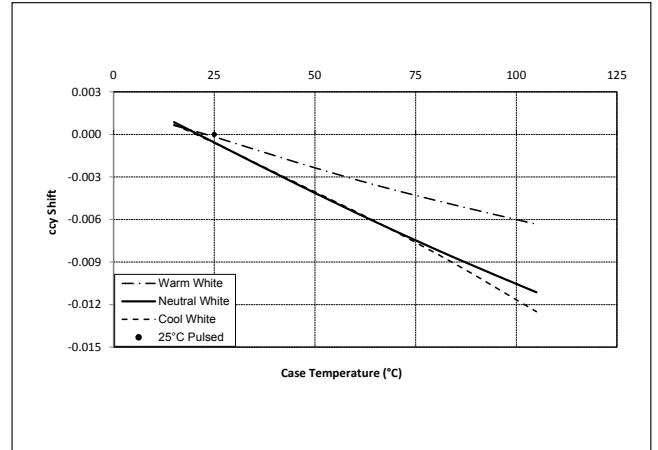

Figure 9: Typical DC ccx Shift vs. Case Temperature

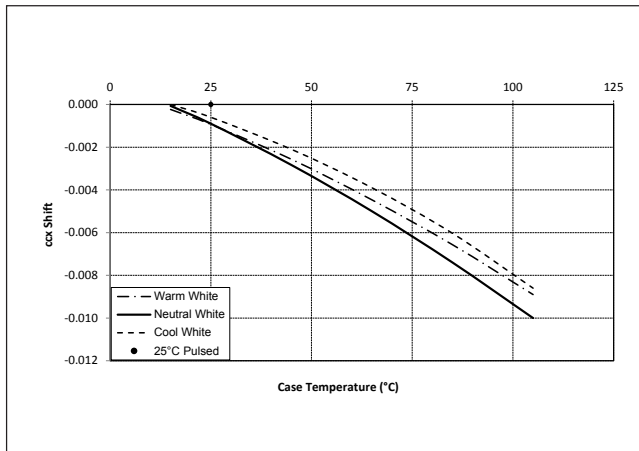
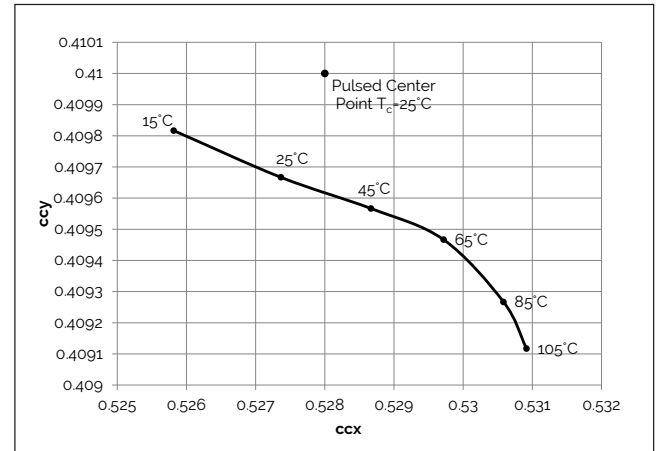

Figure 10: 2000K, 65 CRI Color Shift vs. Case Temperature



Notes for Figures 7 - 9:

1. Characteristics shown for warm white based on 3000K and 80 CRI.
2. Characteristics shown for neutral white based on 4000K and 80 CRI.
3. Characteristics shown for cool white based on 5000K and 70 CRI.
4. For other color SKUs, the shift in color will vary. Please contact your Bridgelux Sales Representative for more information.

Performance Curves

Figure 11: 1750K Color Shift vs. Case Temperature¹

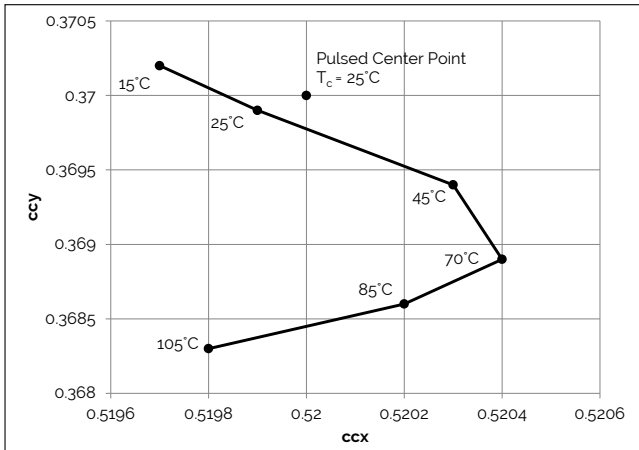

Figure 12: 2500K Color Shift vs. Case Temperature¹

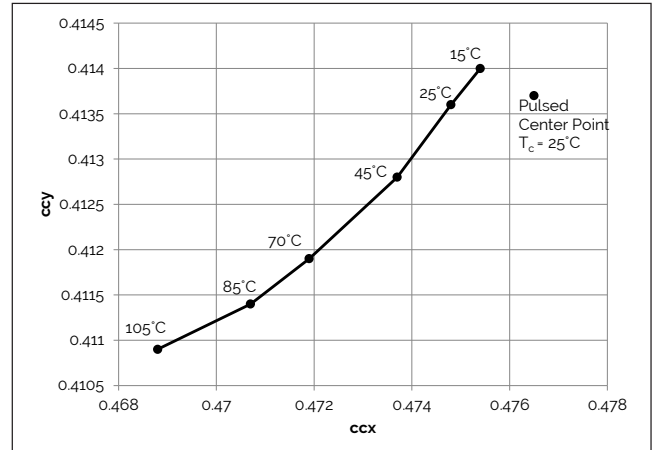

Figure 13: 5600K Color Shift vs. Case Temperature^{1,3}

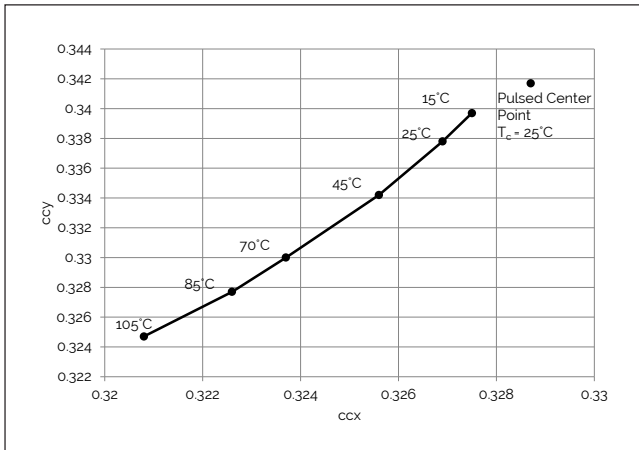

Figure 14: 3000K, Class A Color Shift vs. Case Temperature¹

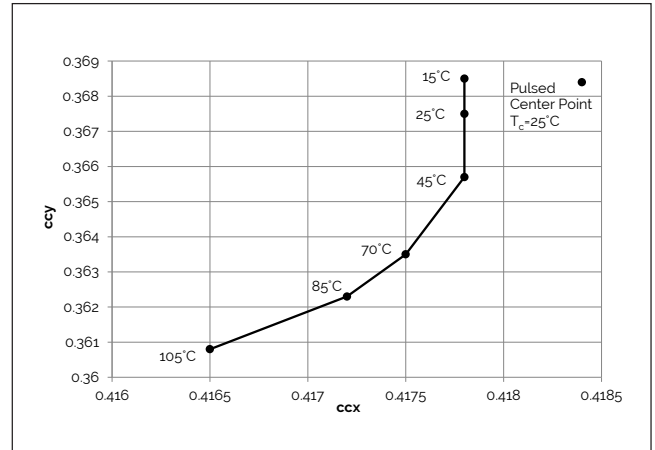

Figure 15: 3500K, Class A Color Shift vs. Case Temperature¹

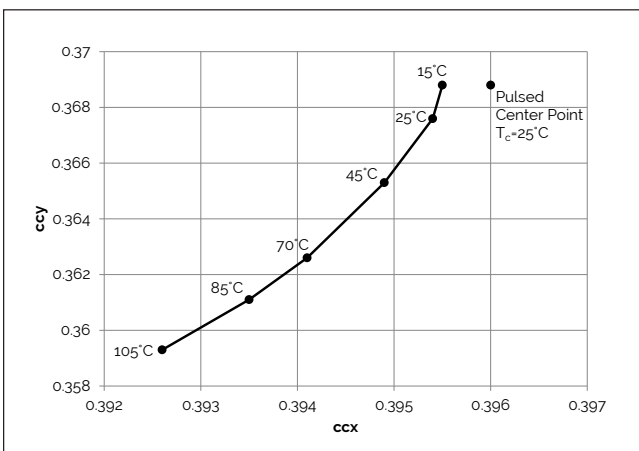
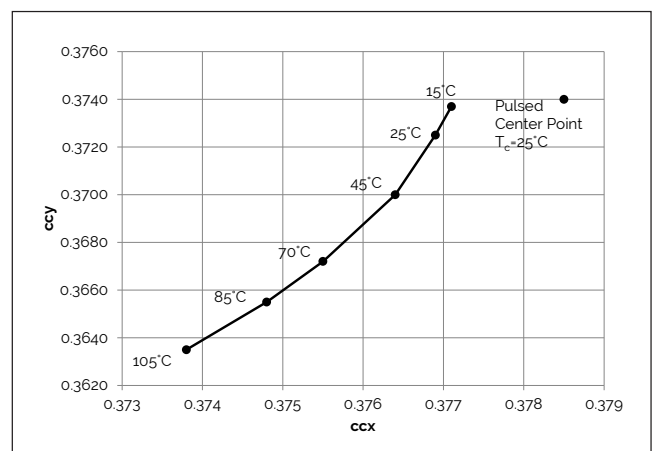

Figure 16: 4000K, Class A Color Shift vs. Case Temperature¹



Note for Figures 10-16:

1. Measurements made under DC test conditions at the nominal drive current.
2. Typical color shift is shown with a tolerance of ± 0.002 .
3. Color shift shown for product hot targeted at $T_c = 85^\circ\text{C}$

Performance Curves

Figure 17: Vero 29D Drive Current Derating Curve

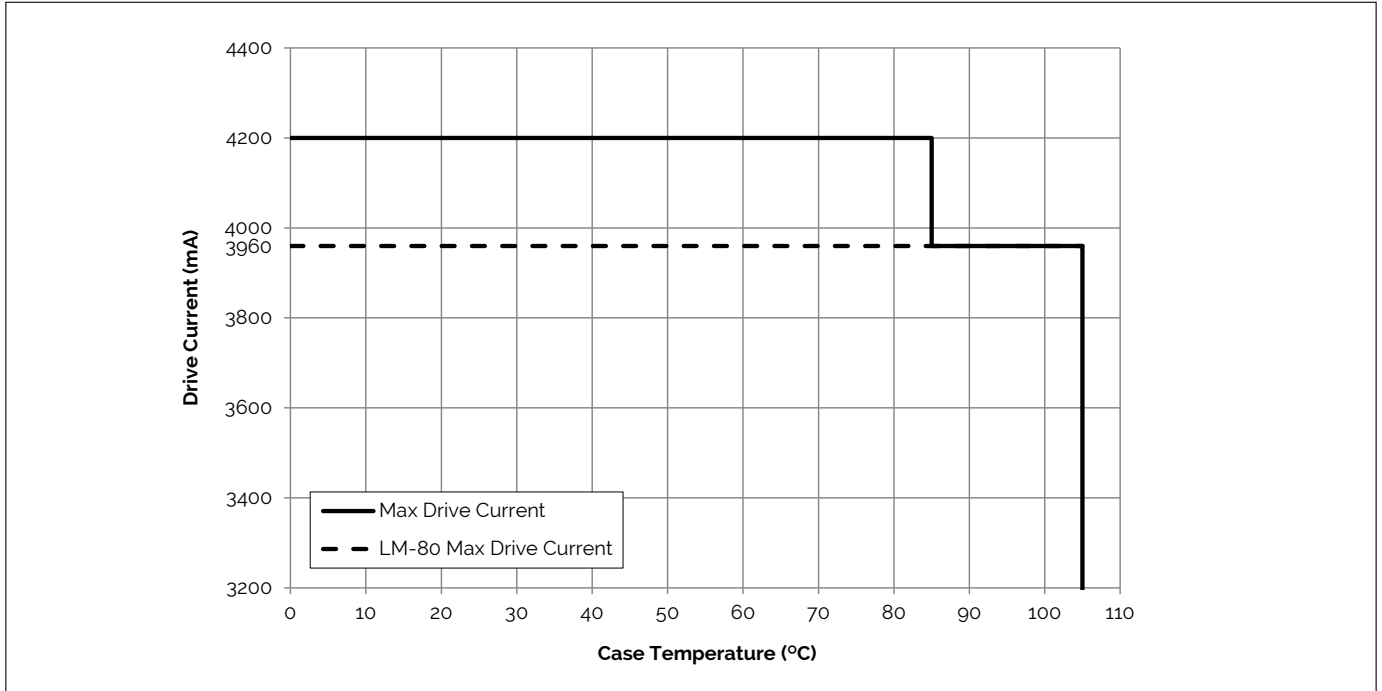

Notes for Figure 17:

1. The maximum allowable drive current for the Vero 29D product is dependent on the operating case temperature. Please refer to the Product Feature Map (page 2) for the location of the T_c Point
2. LM-80 Max Drive Current must not be exceeded in order to meet LM-80 lifetime projections.
3. Lumen maintenance (L70) and lifetime predictions are valid for drive current and case temperature conditions used for LM-80 testing as included in the applicable LM-80 test report for these products. Contact your Bridgelux sales representative for LM-80 report.

Typical Radiation Pattern

Figure 18: Typical Spatial Radiation Pattern

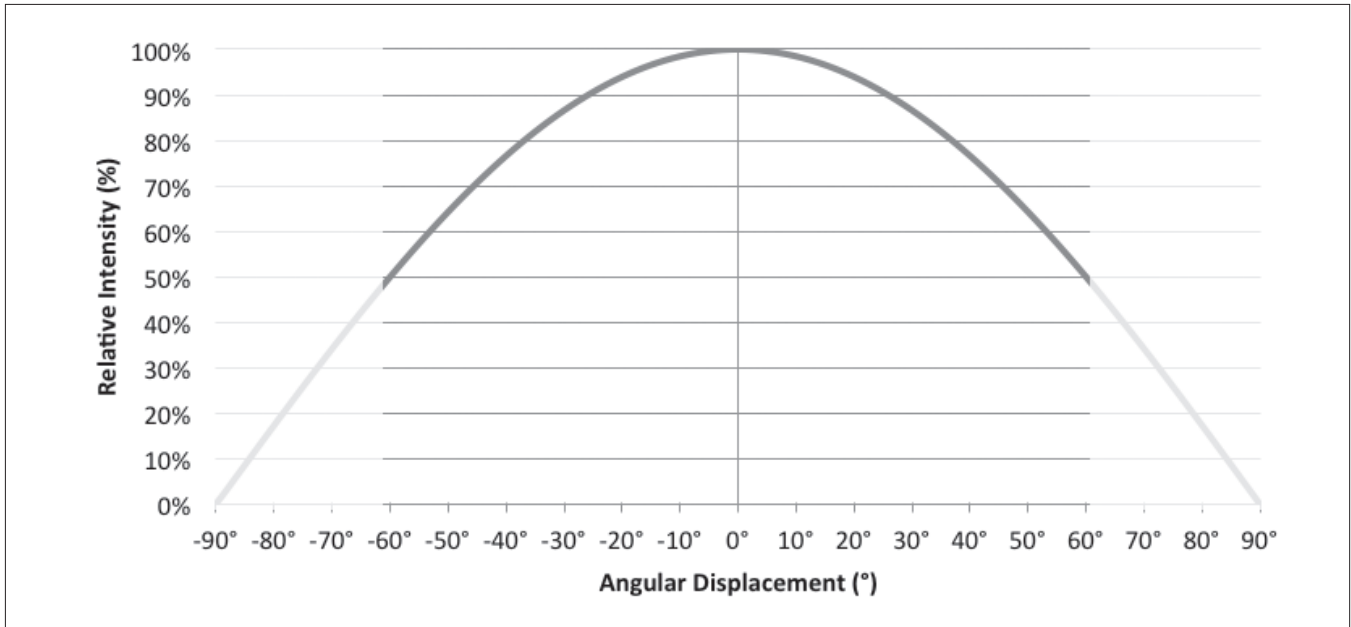

Note for Figure 18:

1. Typical viewing angle is 120°.
2. The viewing angle is defined as the off axis angle from the centerline where intensity is ½ of the peak value.

Figure 19: Typical Polar Radiation Pattern

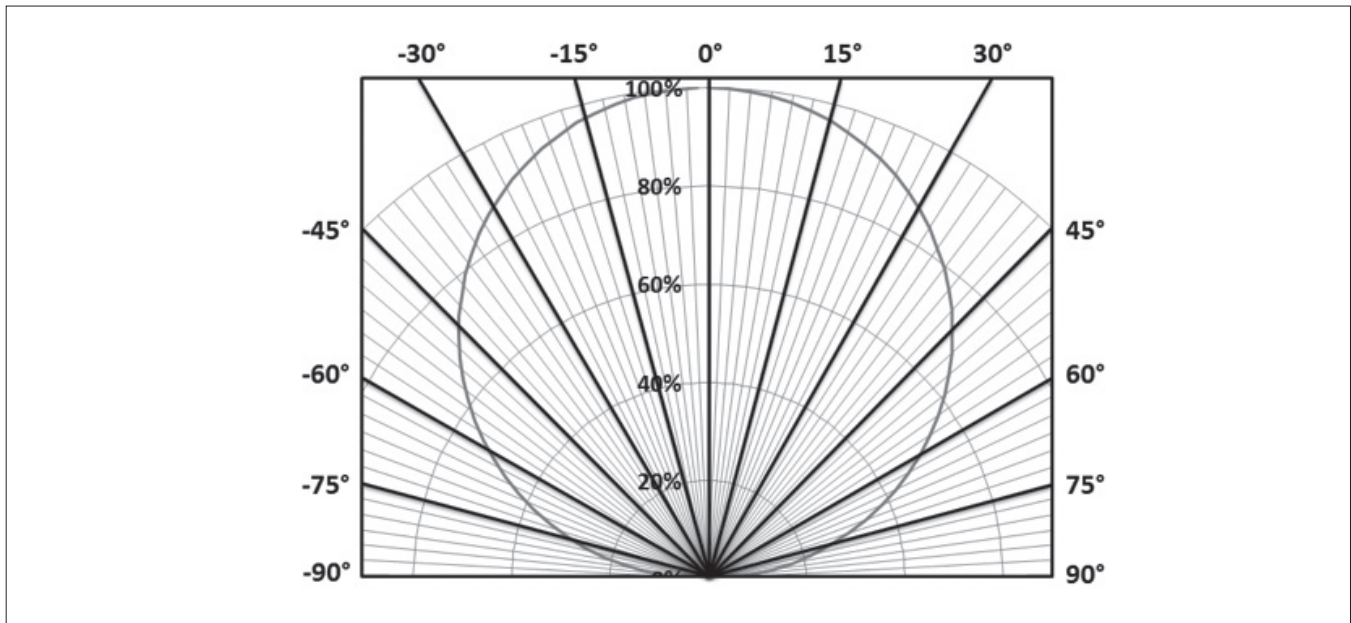

Typical Color Spectrum

Figure 20: Typical Color Spectrum

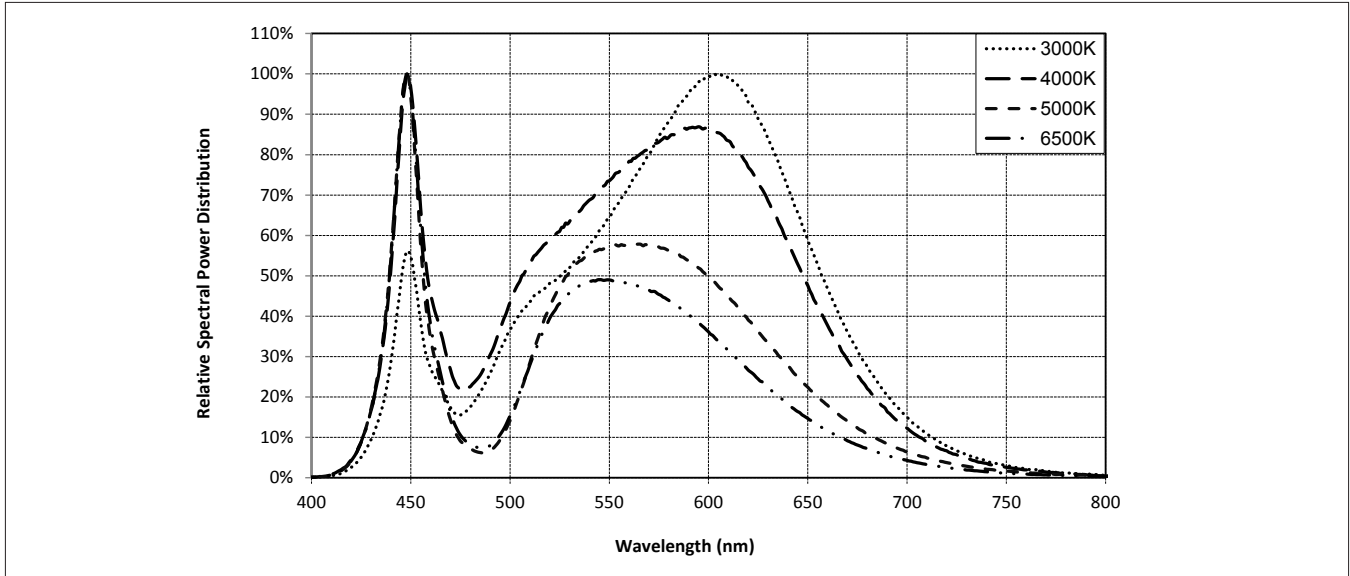

Note for Figure 20:

1. Color spectra measured at nominal current for $T_j = T_c = 25^\circ\text{C}$.
2. Color spectra shown is 3000K and 80 CRI.
3. Color spectra shown is 4000K and 80 CRI.
4. Color spectra shown is 5000K and 70 CRI.
4. Color spectra shown is 6500K and 70 CRI.

Figure 21: Typical Color Spectrum for Vero 29 with Décor Series

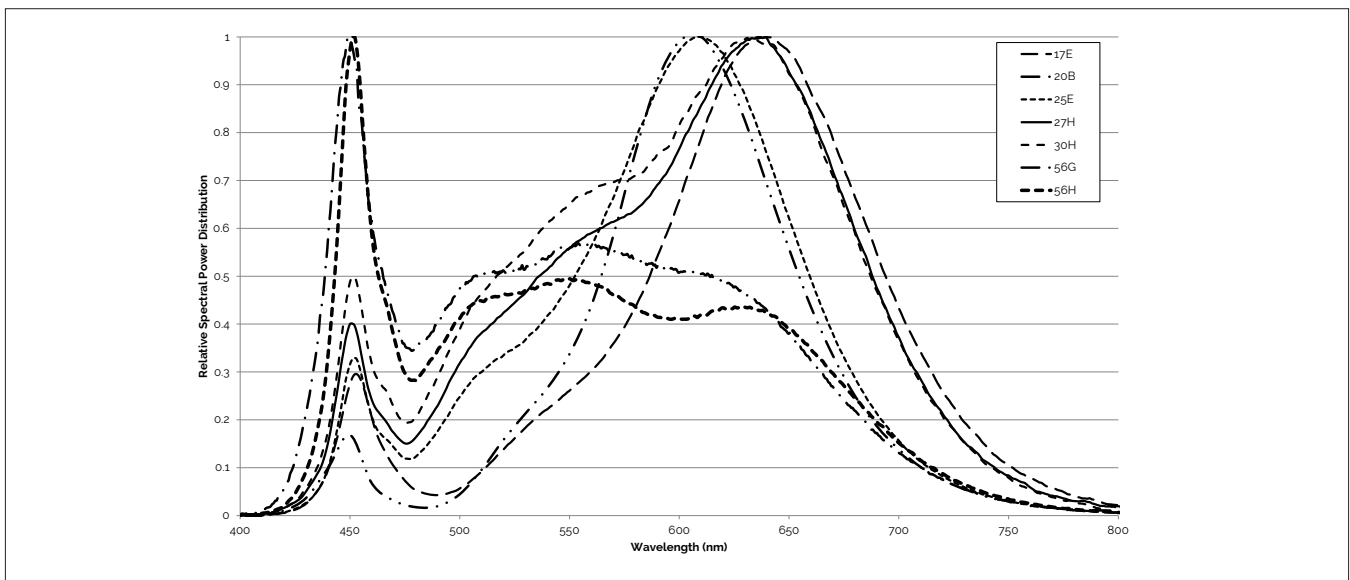

Note for Figure 21:

1. Color spectra measured at nominal current for $T_j = T_c = 25^\circ\text{C}$.

Mechanical Dimensions

Figure 22: Drawing for Vero 29 LED Array

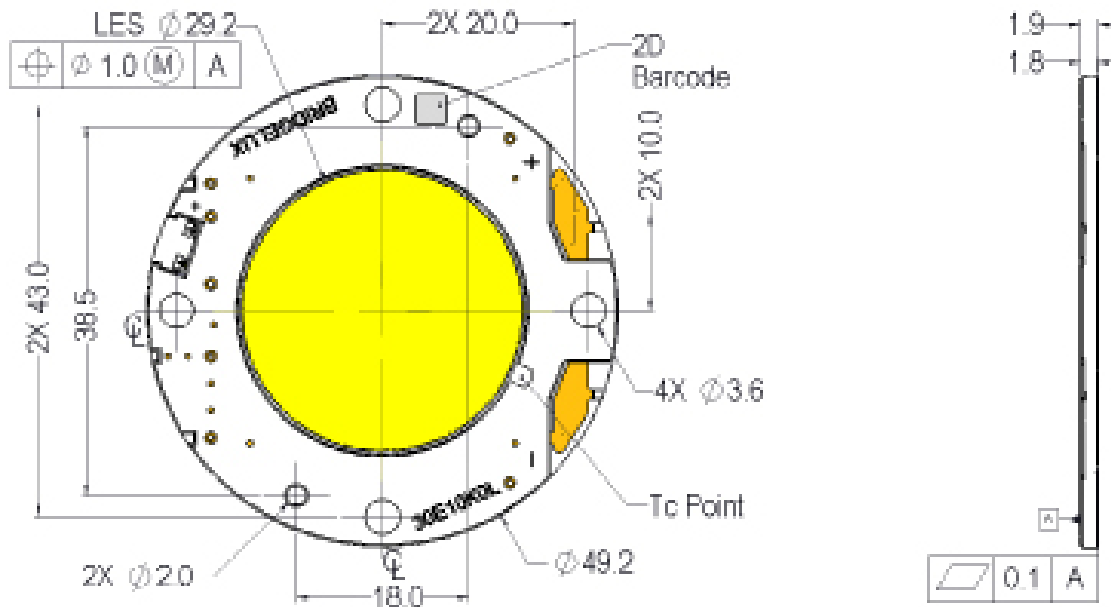

Notes for Figure 22:

1. Drawings are not to scale.
2. Drawing dimensions are in millimeters.
3. Unless otherwise specified, tolerances are $\pm 0.10\text{mm}$.
4. Mounting holes (4X) are for M3 screws.
5. Bridgelux recommends four tapped holes for mounting screws with $43.0 \pm 0.10\text{mm}$ center-to-center spacing.
6. Screws with flat shoulders (pan, dome, button, round, truss, mushroom) provide optimal torque control. Do NOT use flat, countersink, or raised head screws.
7. Solder pads and connector port are labeled "+" and "-" to denote positive and negative, respectively.
8. It is not necessary to provide electrical connections to both the solder pads and the connector port. Either set may be used depending on application specific design requirements.
9. Refer to Application Notes AN30 and AN31 for product handling, mounting and heat sink recommendations.
10. The optical center of the LED Array is nominally defined by the mechanical center of the array to a tolerance of $\pm 0.2\text{mm}$.
11. Bridgelux maintains a flatness of 0.10mm across the mounting surface of the array.

Color Binning Information

Figure 23: Graph of Warm and Neutral White Test Bins in xy Color Space

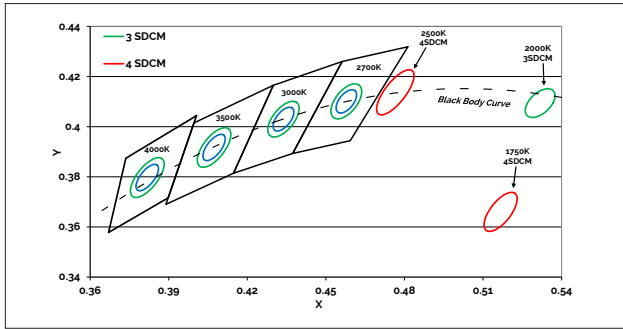

Note: Pulsed Test Conditions, $T_c = 25^\circ\text{C}$

Table 8: Warm and Neutral White xy Bin Coordinates and Associated Typical CCT

Bin Code	1750K	2000K	2500K	2700K	3000K ¹	3500K ¹	4000K ¹
ANSI Bin (for reference only)	-	-	-	(2580K - 2870K)	(2870K - 3220K)	(3220K - 3710K)	(3710K - 4260K)
73 (3 SDCM)	-	-	-	(2651K - 2794K)	(2968K - 3136K)	(3369K - 3586K)	(3851K - 4130K)
72 (2 SDCM)	-	-	-	(2674K - 2769K)	(2995K - 3107K)	(3404K - 3548K)	(3895K - 4081K)
Center Point (x,y)	(0.5167, 0.336)	(0.5280, 0.4100)	(0.4765, 0.4137)	(0.4578, 0.4101)	(0.4338, 0.403)	(0.4073, 0.3917)	(0.3818, 0.3797)

Note for Table 8:

1. Color Binning information excludes Decor Series Class A products. Please contact your Bridgelux Sales Representative for more information.

Figure 24: Graph of Cool White Test Bins in xy Color Space

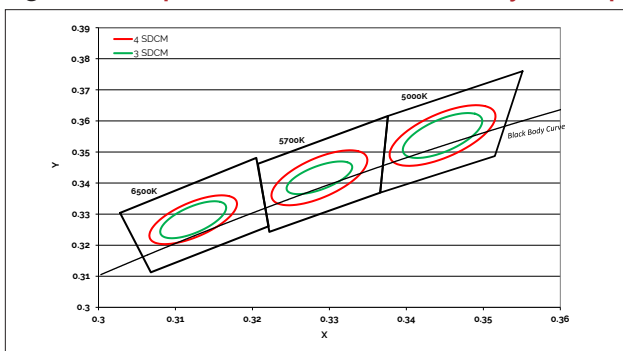

Note: Pulsed Test Conditions, $T_c = 25^\circ\text{C}$

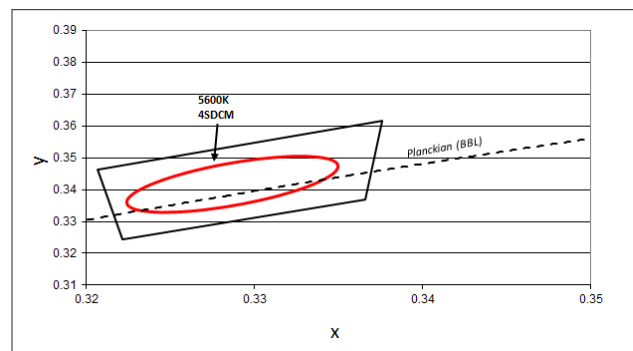

Note: Pulsed Test Conditions, $T_c = 25^\circ\text{C}$

Table 9: Cool White xy Bin Coordinates and Associated Typical CCT (product is hot targeted to $T_c = 85^\circ\text{C}$)

Bin Code	5000K	5600K ¹	5700K	6500K
ANSI Bin (for reference only)	(4745K - 5311K)	(5310K - 6020K)	(5312K - 6022K)	(6022K - 7042K)
74 (4 SDCM)	(4801K - 5282K)	(5475K - 5830K)	(5829K - 5481K)	(6270K - 6765K)
73 (3 SDCM)	(4835K - 5215K)	(5490K - 5820K)	(5490K - 5820K)	(6250K - 6745K)
Center Point (x,y)	(0.3447, 0.3553)	(0.3293, 0.3423)	(0.3287, 0.3417)	(0.3123, 0.3282)

Note for Table 9:

1. Select configurations with a CCT of 5600K are available with center point targets at $T_c = 85^\circ\text{C}$ or $T_c = 25^\circ\text{C}$.

Packaging and Labeling

Figure 25: Drawing for Vero 29 Packaging Tray

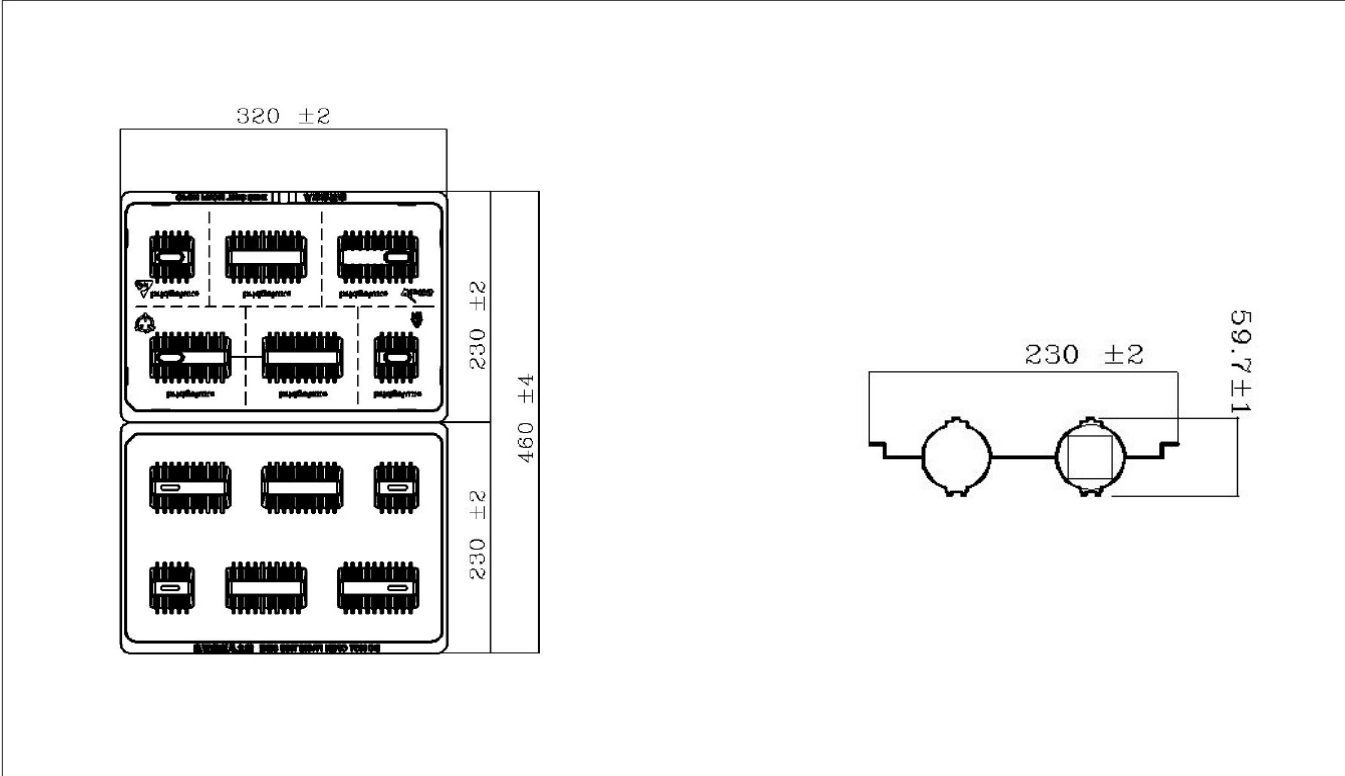

- Notes for Figure 25:
- 1. Dimensions are in millimeters.
 - 2. Drawings are not to scale.

Packaging and Labeling

Figure 26: Vero Series Packaging and Labeling

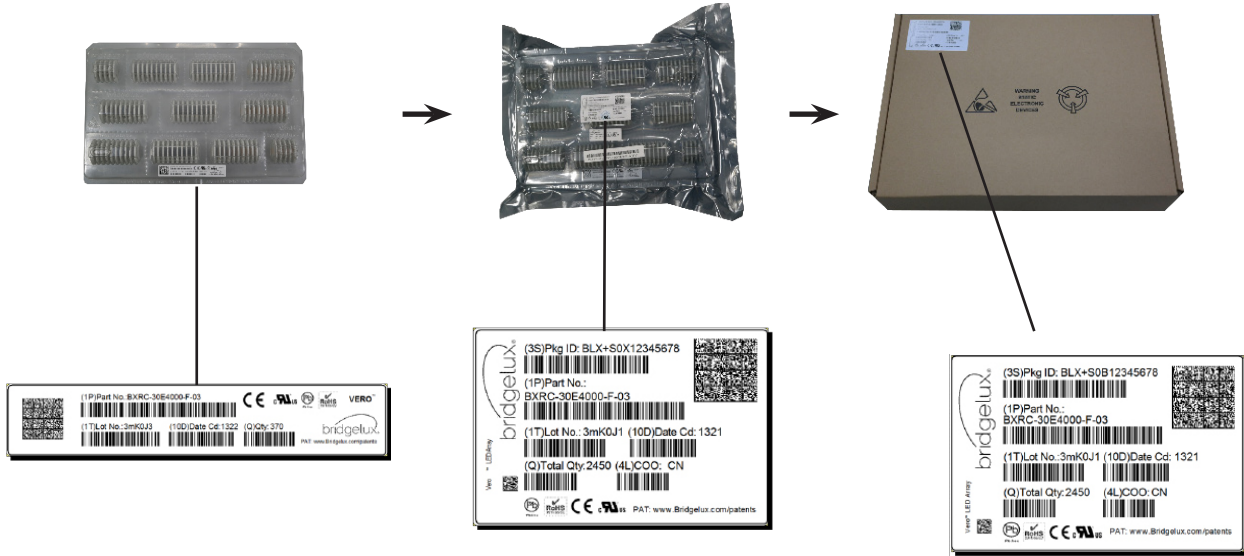

Notes for Figure 26:

1. Each tray holds 50 COBs.
2. Each tray is vacuum sealed in an anti-static bag and placed in its own box.
3. Each tray, bag and box is to be labeled as shown above.

Figure 27: Gen. 7 Product Labeling

Bridgelux COB arrays have laser markings on the back side of the substrate to help with product identification. In addition to the product identification markings, Bridgelux COB arrays also contain markings for internal Bridgelux manufacturing use only. The image below shows which markings are for customer use and which ones are for Bridgelux internal use only. The Bridgelux internal manufacturing markings are subject to change without notice, however these will not impact the form, function or performance of the COB array.



Design Resources

Application Notes

Bridgelux has developed a comprehensive set of application notes and design resources to assist customers in successfully designing with the Vero product family of LED array products. For all available application notes visit www.bridgelux.com.

Optical Source Models

Optical source models and ray set files are available for all Bridgelux products. For a list of available formats, visit www.bridgelux.com.

3D CAD Models

Three dimensional CAD models depicting the product outline of all Bridgelux Vero LED arrays are available in both IGS and STEP formats. Please contact your Bridgelux sales representative for assistance.

LM80

LM80 testing has been completed and the LM80 report is now available. Please contact your Bridgelux sales representative for LM-80 report.

Precautions

CAUTION: CHEMICAL EXPOSURE HAZARD

Exposure to some chemicals commonly used in luminaire manufacturing and assembly can cause damage to the LED array. Please consult Bridgelux Application Note AN31 for additional information.

CAUTION: RISK OF BURN

Do not touch the Vero LED array during operation. Allow the array to cool for a sufficient period of time before handling. The Vero LED array may reach elevated temperatures such that could burn skin when touched.

CAUTION

CONTACT WITH LIGHT EMITTING SURFACE (LES)

Avoid any contact with the LES. Do not touch the LES of the LED array or apply stress to the LES (yellow phosphor resin area). Contact may cause damage to the LED array.

Optics and reflectors must not be mounted in contact with the LES (yellow phosphor resin area). Optical devices may be mounted on the top surface of the plastic housing of the Vero LED array. Use the mechanical features of the LED array housing, edges and/or mounting holes to locate and secure optical devices as needed.

Disclaimers

MINOR PRODUCT CHANGE POLICY

The rigorous qualification testing on products offered by Bridgelux provides performance assurance. Slight cosmetic changes that do not affect form, fit, or function may occur as Bridgelux continues product optimization.

STANDARD TEST CONDITIONS

Unless otherwise stated, array testing is performed at the nominal drive current.

About Bridgelux: We Build Light That Transforms

At Bridgelux, we help companies, industries and people experience the power and possibility of light. Since 2002, we've designed LED solutions that are high performing, energy efficient, cost effective and easy to integrate. Our focus is on light's impact on human behavior, delivering products that create better environments, experiences and returns—both experiential and financial. And our patented technology drives new platforms for commercial and industrial luminaires.

For more information about the company, please visit
bridgelux.com
twitter.com/Bridgelux
facebook.com/Bridgelux
youtube.com/user/Bridgelux
linkedin.com/company/bridgelux-inc-_2
WeChat ID: BridgeluxInChina



46430 Fremont Boulevard
Fremont, CA 94538
Tel (925) 583-8400
www.bridgelux.com

© 2016-2018 Bridgelux, Inc. All rights reserved 2018. Product specifications are subject to change without notice. Bridgelux, the Bridgelux stylized logo design, Vero, V Series and V Series HD are registered trademarks, and Decor Series is a trademark of Bridgelux, Inc. All other trademarks are the property of their respective owners.

Bridgelux Gen 7 Vero 29 Array Series Product Data Sheet DS93 Rev. M (04/2018)