

## General Description

The TOFcam-660 is a cost optimized 3D camera. It is based on the ESPROS proprietary time-of-flight technology using the epc660 TOF flagship chip. The camera controls the illumination and the imager chip to obtain distance and grayscale images. The depth images are compensated against ambient light, temperature and reflectivity of the scene. By using one of the offered ESPROS user interfaces, 3D point clouds in a cartesian coordinate system are available. Thanks to the high performance of the imager chip with the unique ambient light suppression, the camera can be used under full sunlight condition.

This document allows a TOFcam-660 user easily to get the camera connected and started using a computer. It contains a description of all features of the device as well as all functions of GUI and ROS application. The complete description of interfaces, protocols and commands allows to connect the module to integrated systems. A software development kit (SDK) with all C++ source codes, libraries and drivers including is available by ordering the ESPROS epc660 evaluation kit.

## Features

- 320 x 240 pixels QVGA resolution (76'800 pixels)
- Measurement rate up to 20 TOF measurements per second (1.5 MIO distance and amplitude values per second)
- Distance measurement and object recognition from centimeters to 100 meters
- Four different field of view and operating ranges available
- Fully calibrated and compensated
- Sun- and ambient-light tolerant up to 100 kLux
- Ethernet interface
- Various user interfaces: GUI, ROS, Python
  - Evaluation of TOFcam-660 main features
  - Store and recall camera configuration
  - Easy collection of distance data and point clouds
  - Many explanations about "time of flight done right"

## Applications

- Research in various scientific fields
- IoT applications
- Evaluation and development of a epc660 based TOF sensor
  - Automatic vehicle guidance, in-cabin monitoring
  - Object classification and safeguarding
  - Face recognition, Gesture control (man-machine-interface)

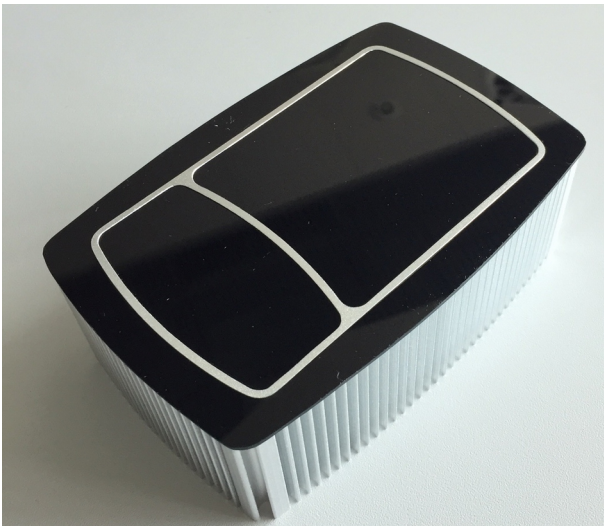

Figure 1: TOFcam-660

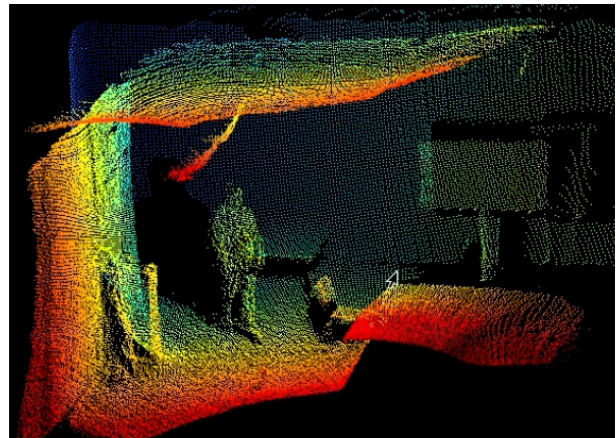

Figure 3: Point Cloud

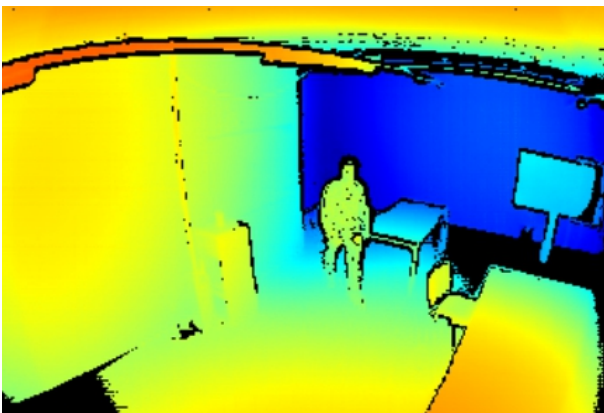

Figure 2: Color coded TOF distance

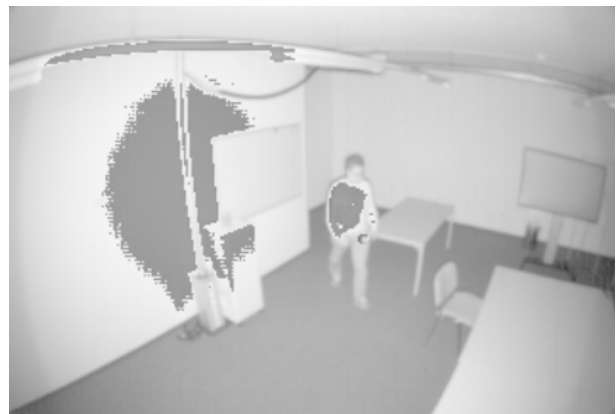











Figure 4: Amplitude as logarithmic gray scale

# Contents

<b>1.</b>	<b>Before you start</b>	<b>3</b>
1.1.	Precaution and Safety	3
1.2.	Updates	3
1.3.	Important Notes	3
<b>2.</b>	<b>Abbreviations</b>	<b>4</b>
<b>3.</b>	<b>Quick guide</b>	<b>6</b>
3.1.	Connecting the camera module	6
3.2.	Camera settings	6
<b>4.</b>	<b>TOFcam-660 time of flight camera</b>	<b>7</b>
4.1.	System overview	7
4.2.	Scope of delivery	7
4.3.	Ordering information	7
4.4.	Technical data	9
4.5.	Mechanical data	10
4.5.1.	Mechanical features	10
4.5.2.	Mechanical dimensions	11
4.6.	Camera connectors	11
4.6.1.	LAN connector	11
4.6.2.	Power and GPIO connector	11
4.6.3.	IP reset button	12
4.7.	Start up	12
4.8.	Firmware upgrade	13
<b>5.</b>	<b>GUI</b>	<b>14</b>
5.1.	GUI main window	14
5.1.1.	View menu	14
5.1.2.	Play menu	17
5.1.3.	Streaming files format description	18
5.1.4.	Live image window	18
5.1.5.	Point cloud	19
5.1.6.	Selective information windows	20
5.2.	Network settings	21
5.3.	Configurations menu	21
<b>6.</b>	<b>Operating the device with a ROS</b>	<b>22</b>
6.1.	ROS camera driver	22
6.1.1.	What is ROS?	22
6.1.2.	Building the ROS driver	22
6.1.3.	Running the ROS driver with launch file	22
6.2.	ROS API	23
6.2.1.	Start of the node	23
6.2.2.	Published topics	23
6.2.3.	Dynamically reconfigurable parameters	24
<b>7.</b>	<b>Communication interface</b>	<b>25</b>
7.1.	Description	25
7.2.	Command Connection (TCP)	25
<b>8.</b>	<b>Communication</b>	<b>26</b>
8.1.	Commands	26
8.2.	Responses	28
<b>9.</b>	<b>Measurement Data Connection (UDP)</b>	<b>29</b>
9.1.	Packetizing (transport layer)	29
9.2.	Payload (application layer)	30
9.3.	Payload Header	30
9.4.	Data types and format of measurement data	31
9.5.	Measurement data	31
<b>10.</b>	<b>Maintenance and disposal</b>	<b>32</b>
10.1.	Maintenance	32
10.2.	Disposal	32
<b>11.</b>	<b>Addendum</b>	<b>33</b>
11.1.	Related documents	33
11.2.	Links	33
11.3.	Licenses	33
<b>12.</b>	<b>IMPORTANT NOTICE</b>	<b>34</b>





# 1. Before you start

## 1.1. Precaution and Safety

	<b>Eye safety: Do not look directly into the camera under operation. Depending on the mode of operation, the camera device emits highly concentrated non-visible infrared light. It can be hazardous to the human eye. The use of these devices has to follow the safety precautions given in IEC62471.</b>
	The camera module is an electronic device. Handle it with the necessary ESD precaution.
	Over-voltage: Use only a power supply which correspond to the data sheet of the camera to avoid damage of the device or cause danger for humans.
	Cable-tripping: Place or mount the camera on solid ground or fix it correctly on a solid support. Place cables carefully. Falling devices can be damaged or harm persons.
	The camera comes with its own calibrated TOFCOS. Do not alter the TOFCOS without obeying the instructions herein.
	Be careful to the window surfaces of the camera. Never use any solvents, cleaners or mechanically abrasive towels or high pressure water to clean the camera.
	Operate the device in compliance with the local EMC regulations.
	This camera is not a safety device. It may not be used in safety applications, explosive atmospheres or in radioactive environment, except the user implements the required safety measures, e.g. by redundancy. However, the sole responsibility for the safety of the application is by the user.
	<b>LIMITED WARRANTY - LOSS OF WARRANTY</b> This camera should only be installed and used by authorized persons. All instructions in this data sheet and in the related documents shall be followed and fully complied with. In addition, the installer and user is required to comply with all local laws and regulations. The installer and user is fully responsible for the safe use and operation of the system. It is the sole responsibility of the installer and the user to ensure that this product is used according to all applicable codes and standards, in order to ensure safe operation of the whole application. Any alteration to the devices by the buyer, installer or user may result in device damage or unsafe operating conditions. ESPROS Photonics AG is not responsible for any liability or warranty claim which results from such manipulation or disregarding of given operating instructions.
	ESPROS Photonics AG is an ISO 9001: 2015 certified company.
	This product is according to European Union standards and free of hazardous substances.

## 1.2. Updates

**ESPROS Photonics is constantly striving to provide comprehensive and correct product information. Therefore, please check ESPROS' website regularly for updated versions of data sheets and documentations: [www.espros.com](http://www.espros.com)**

	Download the latest Flyer of TOFcam-660.
	Download the latest Installation and Operation Manual of the TOFcam-660.
	Download and use the latest software package "TOFCAM660_SW_Package" containing a graphical user interface (GUI) for Windows, Mac or Linux computers, a robot operating system (ROS) application, and a Python API framework. The current firmware "TOFCOS" is part of the GUI which allows an easy upgrade of the camera with current firmware. If there are any questions, please contact your ESPROS sales office or send an email to <a href="mailto:sales@espros.com">sales@espros.com</a> .
	Download and use the latest software development kit (SDK) "TOFCAM660_SDK" containing all source codes of the firmware, GUI, ROS and API. Unpacking the SDK is password protected. Get back to ESPROS to check whether you fulfill the requirements to get the password.

## 1.3. Important Notes

### Notes on PRELIMINARY versions:

**THIS MANUAL IS UNDER CONSTRUCTION. IMPORTANT PARTS MAY BE MISSING**

Colored marking in text means "under consideration" and refers to not yet applicable or verified information.

Values and/or information are either estimates or show the applicable principle only.

## 2. Abbreviations

Designator	Description
3D	Three dimensional
ACK	Acknowledged
ADC	Analog-to-digital converter
API	Application Program Interface
Binning	Summation of a defined number of pixels. Binning can be done in the charge (analog) or in the digital domain
CMD	Command
CPU	Central Processing Unit
CRC	Cyclic redundancy check (checksum)
cwTOF	Continuous wave modulated time of flight
DCS	Differential correlation sample
DLL	Delay locked loop, controllable delay line
DRNU	Distance response non-uniformity: Distance error from pixel to pixel with a target at the same distance
EMC	Electromagnetic compatibility
EMI	Electromagnetic interference
ESD	Electrostatic discharge
FoV	Field of view
fps	Frame rate, number of images per second
Frame	One image
GND	Ground terminal, negative supply voltage
GPIO	General Purpose Input / Output
GS	Grayscale
GUI	Graphical User Interface
HDR	High dynamic range
ID	Identifier
IN	Input terminal which is used to sense a high or low voltage
IP	Internet Protocol address
ISO	International organization for standardization
JEDEC	Joint electron device engineering council
LAN	Local Area Network
LED	Light emitting diode used to illuminate the scenery or as indicator
LSB	Least significant bit
LVTTTL	Low voltage transistor transistor logic
MSB	Most significant bit / byte
NACK	Not acknowledged
NF	Narrow field of view
OUT	Output terminal which is can be set to high or low voltage
QVGA	Quarter Video Graphics Array
RMS	Root mean square
RoHS	Restriction of hazardous substances
ROI	Region of interest in the pixel-field
ROS	Robot Operating System
RX	Receive terminal, data in
SDK	Software Development Kit

<b>Designator</b>	<b>Description</b>
SF	Standard field of view
SW	Software
TBD / tbd	To be defined, information not yet available or not valid
TOF	Time of Flight
TOFCOS	Time of Flight Camera Operating System
TTL	Transistor transistor logic
TX	Transmit terminal, data out
UART	Universal asynchronous receiver transmitter
USB	Universal Serial Bus
UWF	Ultra wide field of view
VDD	Positive supply voltage
WF	Wide field of view

Table 1: List of abbreviations used in this document

### 3. Quick guide

#### 3.1. Connecting the camera module

First of all you need to prepare a power supply for the camera. Therefore use the 6 pin connector which is included in the scope of delivery. If you ordered the power supply and power adapter cable as accessory according to chapter 4.3 then you don't need to provide a separate power supply connected to this 6 pin connector.

You need to install the Graphical User Interface onto your computer. This is available with the software package "TOFCAM660\_SW\_Package" from our download page.

You need to consider the IP address of the camera which is 10.10.31.180 with sub-net mask 255.255.255.0. So you need to operate the camera within the same network range. If your computer has a RJ45 LAN connector you can connect the camera directly with corresponding network settings of the LAN-adapter in your computer. You can choose a manual IP 10.10.31.190 for your computer e.g. If you use a RJ45 to USB adapter you need to configure the settings of your USB adapter accordingly. You can choose a manual IP address 10.10.31.190 for your USB adapter e.g. Disable the firewall on your computer or add an exception for the camera application. The firewall might block the visualization of data in the image window.

- Connect your camera with your computer using a RJ45 patch-cable.
- Connect your camera to the proper voltage using the prepared power supply.
- Start the GUI on your Computer. The connection to the camera will be indicated in the corner bottom left of the main window of the GUI (Connected to 10.10.31.180 - in green letters). This can take around 60 seconds. If there is no connection for several minutes then please disconnect and re-connect the power supply. If this don't help you need to check the network settings of your network adapter as described previously.

#### 3.2. Camera settings

- Choose Image Type "Distance"
- Select HDR mode "HDR temporal" with integration times: "low" = 1000µs / "medium" = 2000µs / "high" = 4000µs Depending on distance and reflectivity of the objects in the scene these values need to be reduced.
- For object detection set the "Minimum Amplitude" to 10 LSB, for accurate measuring to 100 LSB (this are good starting points, fine-tuning possible).
- Set the "Distance min" value to 100 mm and the "Distance max" to the effective maximum distance in your scenery.
- Disable all Filter functions.
- Depending on the maximum distance in your field of view you should choose a suitable "Modulation frequency" (unambiguity). For long distance a low modulation frequency is required.
- If you choose a modulation frequency which is not 12 MHz (24 MHz e.g.) the camera is not calibrated. In this case it might be required to consider a corresponding offset.
- Start streaming with the "Start" button.
- Decrease the "Integration time 3D low" to a value where you get no ADC overflow (pink) or saturated pixels (purple). Adjust the integration time "medium" and "high" accordingly.
- Play with filtering: enable "Temporal Filter" e.g.
- Optimize the color scale (visual graduation) of the relevant objects in your scenery by changing the "Distance min" value.
- Change the image type to the illustration of the scenery you like to see.

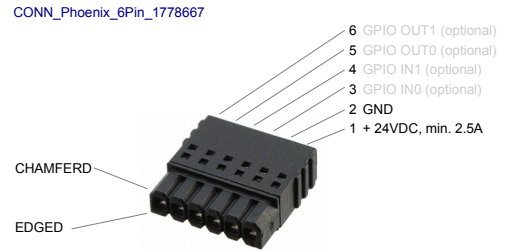

Figure 5: 6-pin power-supply and GPIO connector

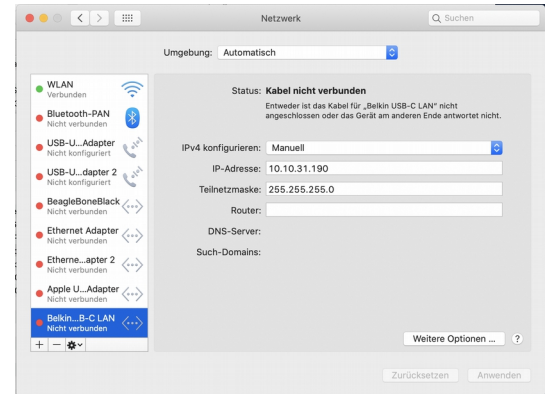

Figure 6: IP configuration of a USB-LAN adapter

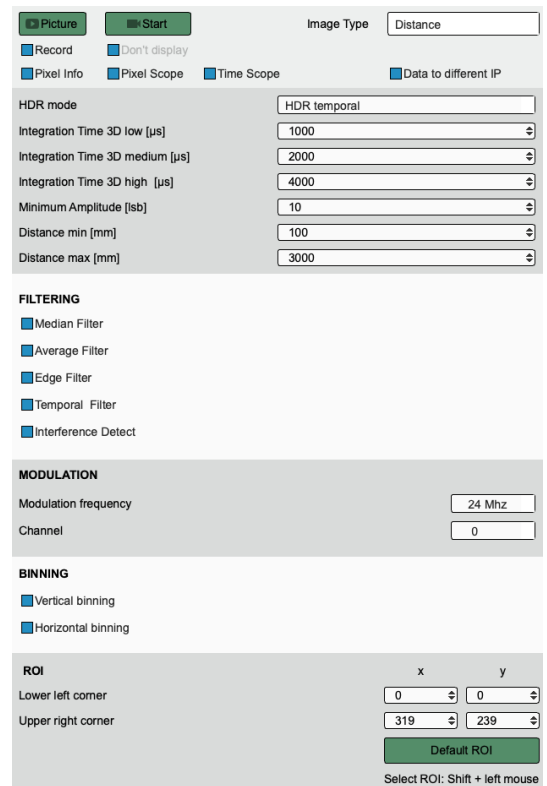

Figure 7: GUI window for camera settings

## 4. TOFcam-660 time of flight camera

### 4.1. System overview

The TOFcam-660 is a general purpose camera based on the ESPROS epc660 cwTOF imager chip:

- 24VDC power supply input
- RJ45 LAN connector
- General purpose I/O connector
- NXP I.MX RT1062 microcontroller
- The micro controller board communicates with the epc660 chip carrier board through an ultrafast TCMI serial interface.
- One out of four different lenses depending on the camera model focus the reflected light from the scenery onto the pixel field of the imager chip.
- NIR band pass filter, AR coatings and stray-light suppression for optimal optical performance
- LED illumination adopted to the specific field of view depending on the camera model
- TOF camera operating system (TOFCOS) for camera control, distance calculation and filtering
- Communication by Ethernet
- Application programming interface (API) for further processing is available. It opens the world for point cloud computing, using open source tools or creating own customer applications.
- ROS device drivers for Linux available
- Windows, Mac and Linux GUI available

### 4.2. Scope of delivery



Pieces	Part Name	Picture
1	Time of Flight Camera TOFcam-660 consisting of: <ul style="list-style-type: none"> <li>- Aluminum housing</li> <li>- Receiver optic</li> <li>- Illumination cpl.</li> <li>- CPU electronics</li> <li>- interfaces</li> </ul>	
1	6 pin connector plug for 24V power supply and GPIO <ul style="list-style-type: none"> <li>- Plug with snap-fit clamps</li> <li>- Connecting instructions</li> <li>- Pin assignment</li> </ul>	
4	Self tapping screws for camera mount	
1	Software package containing GUI, ROS, Python API and current Firmware. Available on the ESPROS download page.	
1	Documentation (useful additional information available on the ESPROS download page )	

Table 2: Scope of delivery

### 4.3. Ordering information

Picture	Part No.	Name	Description
	P100 654	TOFcam-660-NF	FoV 31 x 24°, 81m operating range 50LSB on 18% reflective target at full sunlight
	P100 655	TOFcam-660-SF	FoV 70 x 51°, 25m operating range 50LSB on 18% reflective target, up to 78kLux
	P100 656	TOFcam-660-WF	FoV 108 x 77°, 11m operating range 50LSB on 18% reflective target at full sunlight

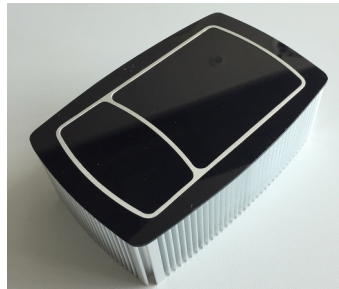

	P100 595	TOFcam-660-UWF	FoV 125 x 93°, 6m operating range 50LSB on 18% reflective target
	P100 638	24VDC connector	Included in TOFcam-660 basic unit. To connect the camera to a corresponding power supply.
	P100 609	Power adapter cable	Cable to connect a TOFcam-660 directly with the power supply P100 282
	P100 282	Power Supply 24VDC	Input 100 ... 240V DC output: 24V, 2.5A
	P100 284	Power cord 2 pole	CH/EU plug
	P300 189	Power cord adapter CH/EU - US	
	P300 780	Patch cable, 2m, RJ45	
	P300 781	Adapter RJ45 to USB	
	P300 473	Cable USB A to Micro USB	

Table 3: Order information for cameras and accessories



#### 4.4. Technical data

All characteristics are at typical operational temperature  $T_A = +25^\circ\text{C}$

Parameter	Description	Conditions	Min.	Typical	Max.	Units	Comments
$V_{DD}$	Main supply voltage	Ripple <sup>1</sup> < 50 mV <sub>pp</sub>	–	24	–	VDC	
$I_{DD}$	Supply current		–	–	–	A	
$\lambda$	Operating wavelength			940		nm	
$RES_{IMAGE}$	Image resolution			320 x 240		Pixel	QVGA
FoV	Field of view	Version NF		31 x 24		°	Refer to Chapter 4.3
		Version SF		70 x 51		°	
		Version WF		108 x 77		°	
		Version UWF		125 x 93		°	
$D_R$	Measuring range in dark	Version NF	0.5		96	m	2% accuracy on 90% reflective target, dark
		Version SF	0.3		38	m	
		Version WF	0.2		18	m	
		Version UWF	0.2		12	m	
$D_M$	Measuring range on full sunlight	Version NF	0.5		38	m	2% accuracy on 90% reflective target, 100kLux ambient light
		Version SF	0.2		10	m	
		Version WF	0.2		5	m	
		Version UWF	0.2		4	m	
Acc	Accuracy, measuring range min. ... 2m			± 4		cm	Mean of 100 samples
	Accuracy, 2m ... measuring range max.			± 2		%	
$f_{MOD}$	Modulation frequency selectable		0.75		24	MHz	Refer to unambiguity range
$D_{Unambiguity}$	Unambiguity range <sup>2</sup>	@ $f_{MOD} = 24\text{MHz}$		6.25		m	
		@ $f_{MOD} = 12\text{MHz}$		12.5		m	
		@ $f_{MOD} = 6\text{MHz}$		25		m	
		@ $f_{MOD} = 3\text{MHz}$		50		m	
		@ $f_{MOD} = 1.5\text{MHz}$		100		m	
		@ $f_{MOD} = 0.75\text{MHz}$		200		m	
$f_{SHIFT}$		Channel 0		0			To avoid interference in multi camera operation environment
		Channel 1		$-f_{MOD} / 30$		MHz	
		Channel 2		$-f_{MOD} / 34$ approx.		MHz	
		Channel 3		$-f_{MOD} / 40$		MHz	
		Channel 4		$-f_{MOD} / 48$		MHz	
		Channel 5		$-f_{MOD} / 60$		MHz	
		Channel 6		$-f_{MOD} / 80$		MHz	
		Channel 7		$-f_{MOD} / 120$		MHz	
		Channel 8		$-f_{MOD} / 240$		MHz	
		Channel 9		$+f_{MOD} / 240$		MHz	
		Channel 10		$+f_{MOD} / 120$		MHz	
		Channel 11		$+f_{MOD} / 80$		MHz	
		Channel 12		$+f_{MOD} / 60$		MHz	
		Channel 13		$+f_{MOD} / 48$		MHz	
		Channel 14		$+f_{MOD} / 40$		MHz	
		Channel 15		$+f_{MOD} / 34$ approx.		MHz	
Channel 16		$+f_{MOD} / 30$		MHz			
$t_{INT}$	Integration time selectable for distance		1		4'000	µs	
	Integration time selectable for gray scale		1		100'000	µs	

Parameter	Description	Conditions	Min.	Typical	Max.	Units	Comments
$t_{\text{CYCLE}}$	Measurement cycle time for full TOF image			–		s	@ $t_{\text{INT}} = 1'000\mu\text{s}$
$t_{\text{PWR\_UP}}$	Power up time until acceptance of commands				1.5	s	
$t_{\text{WARM\_UP}}$	Warm-up time until output data is in tolerance			–		s	
$\Phi_{\text{AL}}$	Ambient-light suppression			> 100		kLux	Indirect, on target
$T_{\text{A}}$	Ambient temperature range		-20		60	°C	Operation and storage
RH	Relative humidity		15		90	%	Non-condensing
W	Weight			600		g	Without cable
ESD	Electrostatic discharge rating		JEDEC HBM class 1C (1kV to < 2kV)				Human body model
EMC / EMI	EMC emission		EN 61000-6-3:2011-09				
	Eye safety		IEC 62471:2006				Refer to Chapter 1.1.

Table 4: Technical data

Notes:

- <sup>1</sup> Min. and Max. voltage values include noise and ripple voltage
- <sup>2</sup> The camera uses the continuous-wave TOF phase-shift measurement technique. Highly reflective objects outside of the unambiguity distance will appear closer due to the wrap-around of the modulation period.
- <sup>3</sup> To reliably avoid interference in multi camera applications the effective modulation frequency of the selected channels should differ for at least 50 kHz between each single unit. Thus at modulation frequencies lower than 12 MHz not all channels should be used.

## 4.5. Mechanical data

### 4.5.1. Mechanical features

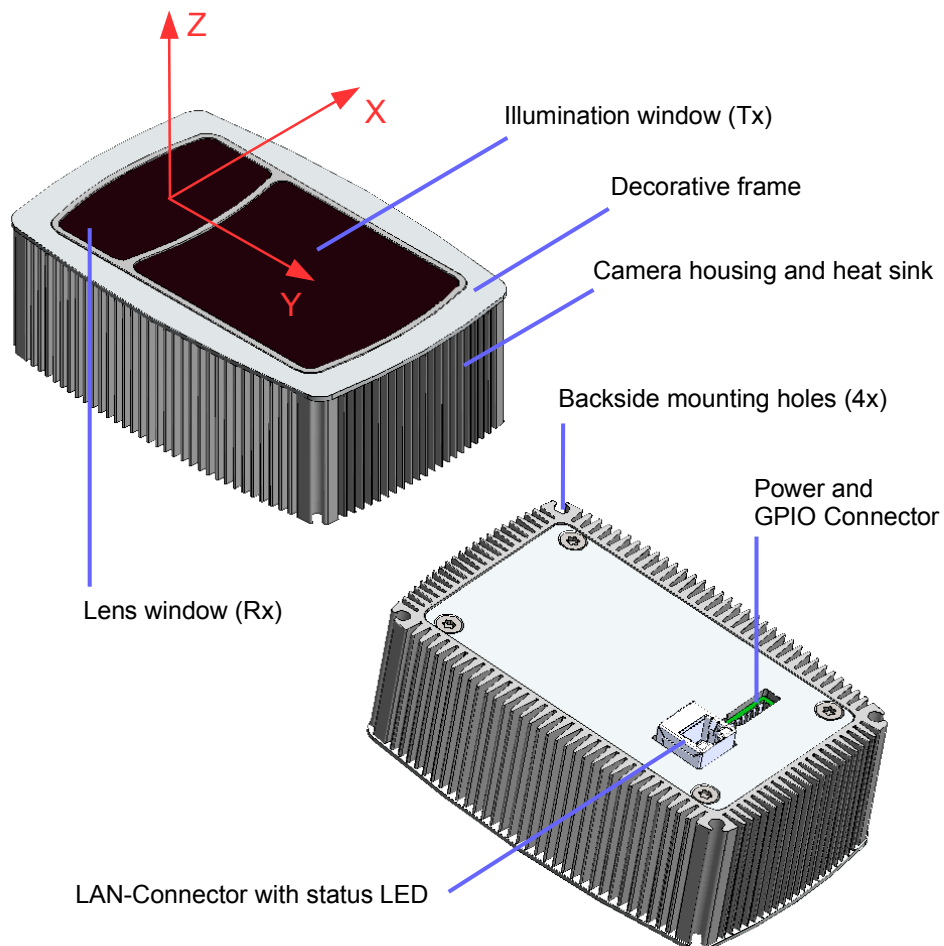

Figure 8: Mechanical features

#### 4.5.2. Mechanical dimensions

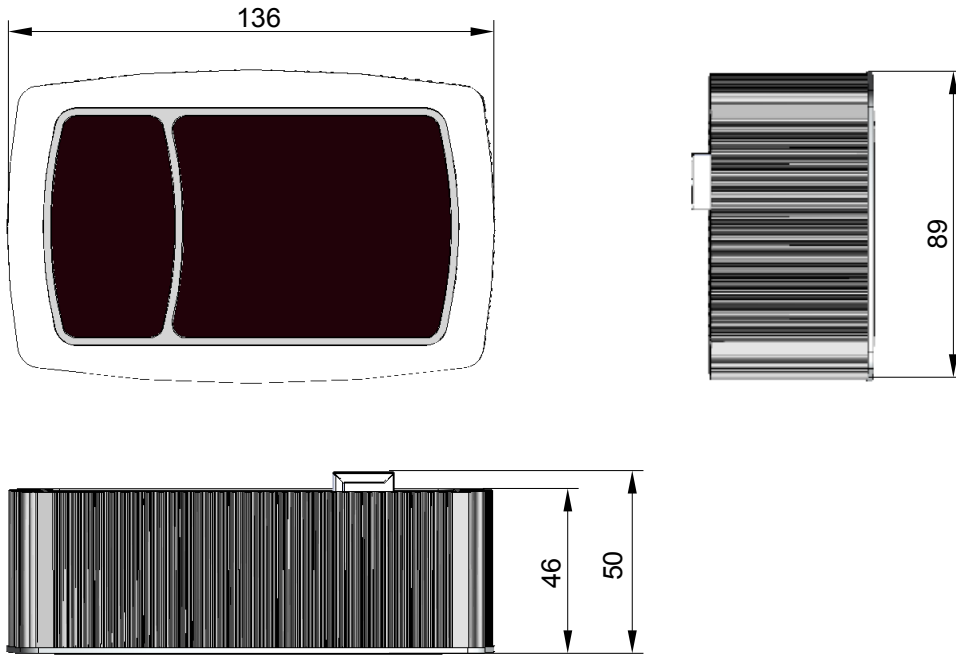

Figure 9: Camera dimensions

#### 4.6. Camera connectors

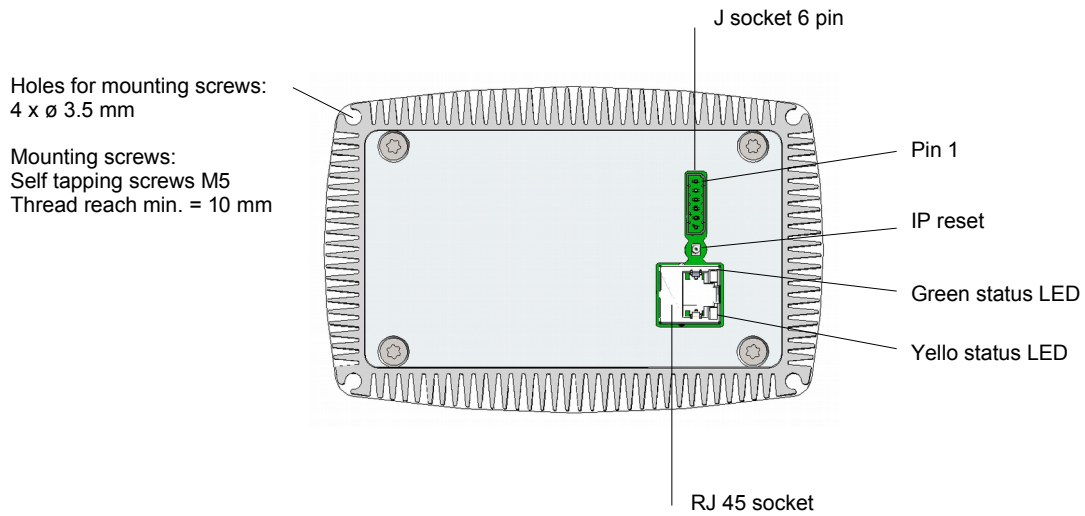

Figure 10: Camera connectors

##### 4.6.1. LAN connector

Connector type: THD Connector RJ45, 8P8C 1000BASE-T

Matching plug: any RJ45 8P8C plugs

Accessory: LAN cables and Ethernet to USB adapter available as accessories. Refer to Chapter 4.3.

##### 4.6.2. Power and GPIO connector

Connector type: Term Block, R/A, 6 Pos STR 2.5mm

Matching plug: Term Block Plug, 6 Pos STR 2.5mm

Accessory: For matching connector plug refer to Chapter 4.3.

No.	Name	Function	Comments
1	VDD	VDD: +24V	Stable and free of noise power supply for the imager section.
2	GND	Negative supply terminal	
3	PIN3	IN 0	Open-drain input, refer to toFigure 11
4	PIN4	IN 1	
5	PIN5	OUT 0	Digital output, refer toFigure 12
6	UART_TX	OUT 1	

Table 5: Pin table

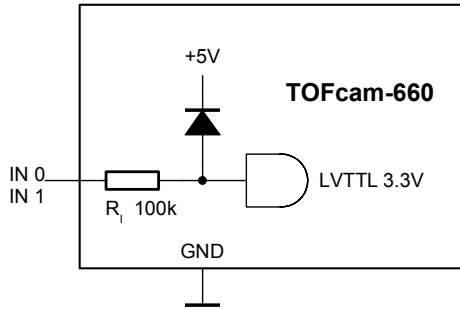

Figure 11: Input pins IN 1 and IN 2

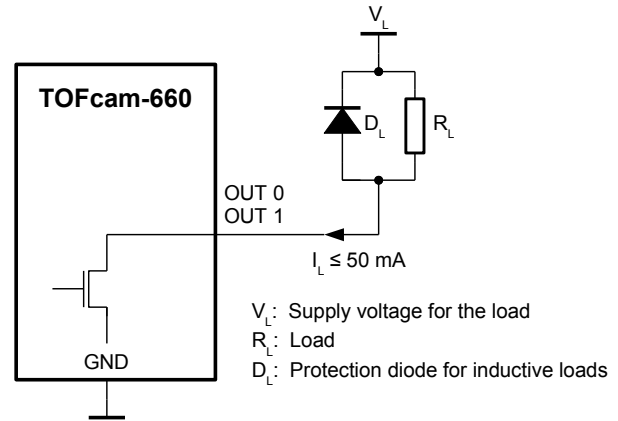

Figure 12: Output pins OUT1 and OUT2



Make sure to use the right plug and insert it properly to avoid damage of the device connector!

#### 4.6.3. IP reset button

If you get no connection to a TOFcam-660 with changed and unknown IP address the IP reset button allows you to reset the IP to factory standard of 10.10.31.180. Therefore press the button for 5 seconds during start-up of the camera.

#### 4.7. Start up

The camera has a factory set IP address which is 10.10.31.180 with a sub-net mask 255.255.255.0. You need to adjust the network settings of the host computer according to this address. The LAN needs a 1000MB/s capability. Ensure that your firewall do not block the data visualization in the image window. In most cases you need to disable the firewall or to set an exception for the camera application.

- Connect your camera directly with your computer using a RJ45 patch-cable or additionally using a RJ45 to USB adapter.
- Connect your camera to the proper voltage using the prepared power supply.
- Start the GUI on your Computer.

The device notifies the power-up with a constantly lighting green LED. During network communication start-up the yellow status LED is flashing. This can take up to 60 seconds. In the corner bottom left the GUI shows the network connection status. If there is no connection for several minutes then please disconnect and re-connect the power supply. If this don't help you need to check the network settings of your network adapter as described previously.

Error cases:

- If the green status LED do not light then the camera is not connected to a suitable power supply or not connected to a network adapter.
- If the GUI indicates the camera as "Disconnected from 10.10.31.180" then the network settings are incorrect.
- If the GUI indicates the camera as "Connected to 10.10.31.180" but "Start" a data stream do not open an image window then the firewall blocks the application or the LAN has too low transfer rate.

## 4.8. Firmware upgrade

To upload the firmware over ethernet you need to do the following steps:

1. Click the “Update firmware” button in GUI, refer to Chapter 5.3

or

Send command “JUMP\_TO\_BOOTLOADER“, open a new browser-window and type the current IP of the TOFcam-660 into the address line of the browser

2. Erase the current camera application. You need to confirm the deletion using the password TOFcam-660
3. Choose the update file (usually “cameraApplication\_XiP.bin“) by browsing your harddisk. The firmware according GUI release date is included in the folder “firmware“ included in “TOFCAM660\_SW\_Package“ from the ESPROS download page.
4. Start the firmware upgrade process with the “Upload“ button.
5. Start the TOFcam-660 to check whether the firmware upgrade was successful.



Figure 13: Figure 11: Browser based bootloader tool

## 5. GUI

First, before installation of a new software release, read the README and CHANGELOG files of the download package to get latest product information.

### 5.1. GUI main window

After starting the “TOFCAM660” application, the control window of the GUI appears. The software connects automatically to the device if a camera is physically connected to the computer. The connection is indicated in the status indicator line in the footer of the control window, the header shows the GUI version in use, the current firmware installed on the camera as well as the wafer and chip ID of the epc660 imager. The menu selection on the left side bar allows a user to step into the GUI control options.

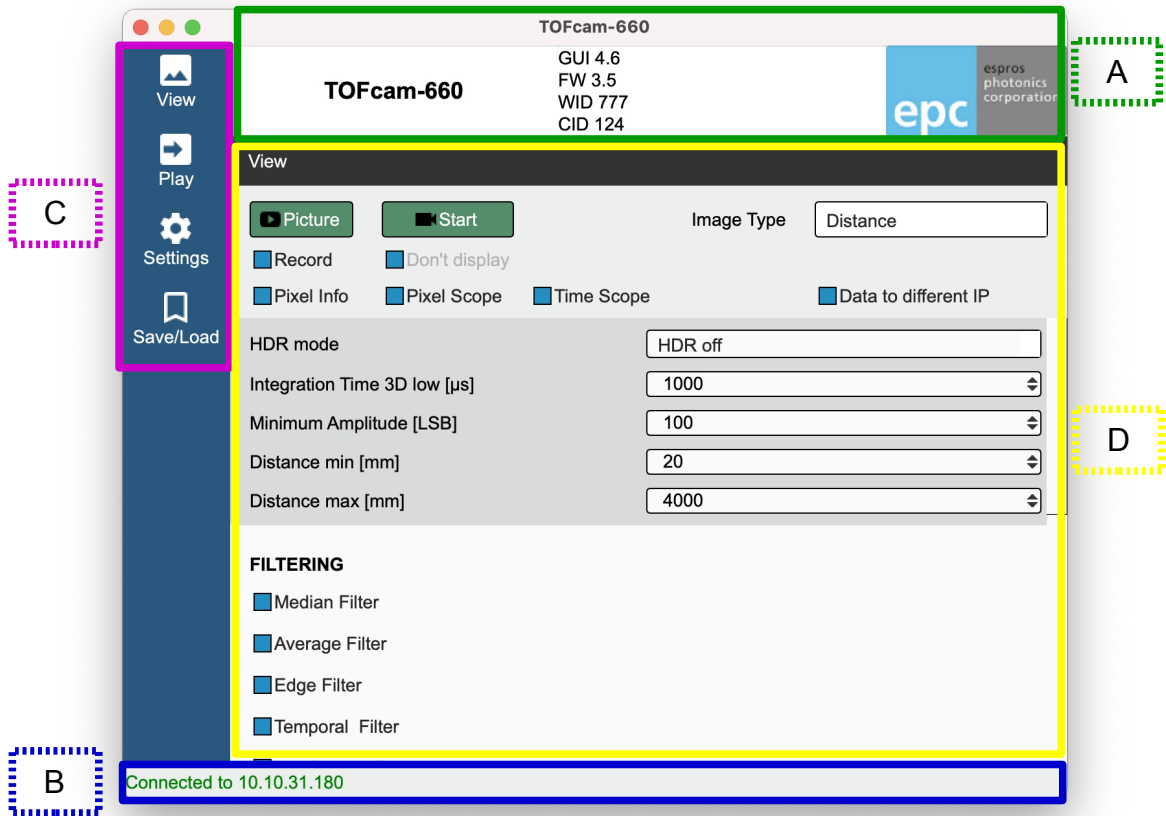

Figure 14: Sections of the GUI main screen

- A) Camera type, GUI version, Firmware version, Chip-/Wafer-ID of the epc660 in the connected camera
- B) Connection status:
- C) Menu tab
  - View Chapter 5.1.1
  - Play Chapter 5.1.2
  - Settings Chapter 5.2
  - Save/Load Chapter 5.3
- D) Controls for the selected menu tab

#### 5.1.1. View menu

The View menu allows to control the camera and the camera output. Distance, amplitude and gray-scale images, DCS (raw data) or point clouds can be captured, streamed or recorded. Detailed information about pixel groups or one single pixel can be illustrated. For the whole GUI there are helpful tooltips available. These tooltips pop-up by moving the cursor either to the corresponding text (refer to Figure 16).

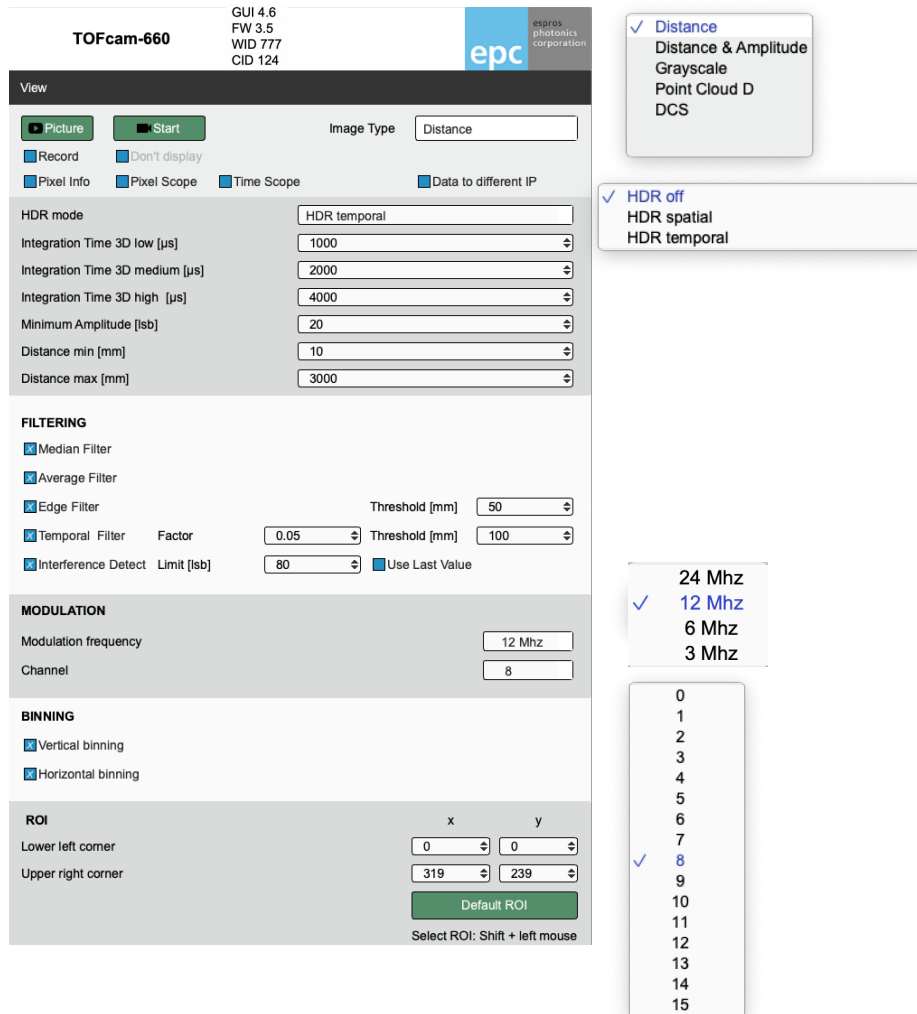

Figure 15: Camera controls

- “Picture” and “Start” open the “Image” window according to the selection in the “Image Type” drop-down menu. Please see Chapter 5.1.4 to read the details about the live image window. The “Picture” button acquires one single frame while the “Start” button starts a live stream. It changes its look to “Stop” which allows terminating the streaming.
- “Record” function allows to save picture data (one picture per push on the “Image” button) or as live stream (from “Start” to “Stop” command each). On computers with low performance it might be helpful to enable the “Don't display” function to use all resources for recording the live stream. The recorded data contains all values according to the selected “Image Type”.
- “Data to different IP” allows to stream the data record to another device than the one which controls the camera.
- The “Info” and “Scope” check boxes open additional windows with dedicated information. You will find additional description about these functions in Chapter 5.1.6.
- “HDR off” let's the camera operate with one integration time only.
- “HDR spatial” operates all odd rows of the imager with the “Integration Time 3D low” value and all even rows with the “Integration Time 3D medium” value.
- “HDR temporal” allows using up to 3 different integration time values (integration times with zero values are ignored). In this mode one complete image is acquired with each set integration time 3D low ... high. After the acquisition of all frames, a new image is generated from the different frames by using the most confident value (pixel by pixel). Due to multiple image acquisitions, this mode reduces the frame rate.
- Integration time setting allows to define the exposure time to acquire one Differential Correlation Sample (DCS). Four DCS' are required for distance acquisition.
- A minimal amplitude can be set. This is the minimum received signal to provide distance. One should use low limits for object recognition but high limits for accurate distance measurements. Please investigate the TOF theory to become familiar with the physical context. A very helpful lecture might be the book “3D-TOF, A guideline to 3D-TOF sensors that work” by ESPROS Photonics Corp. (author Beat De Coi et. al.).
- “Distance min” cuts off all pixels reporting a value below this setting. In addition, the color distance minimum scale is adjusted to this setting.
- “Distance max” cuts off all pixels reporting a value beyond this setting. In addition, the color distance maximum scale is adjusted to this setting.

- The color scale visualizes distance of every pixel in the viewer. Dark red represents the shortest, dark blue the farthest distances.
- Various powerful filter functions are available with specific thresholds and filter factors. The algorithms behind are shown in corresponding tooltips.
- To avoid interference issues due to unknown systems disturbing the sensor a “Interference detection” can be enabled. Interfered pixels will be detected automatically and indicated as “invalid data”. By selecting the “use last value” function the last valid value is sent for the affected pixel instead of marking it as invalid. This function is also be used to suppress motion blur.
- The modulation frequency defines the unambiguity range. Refer to Chapter 4.4
- “Modulation channel” selection allows a shift of the modulation frequency from the main (default) modulation frequency. Multiple cameras operating in the same scenery (full or partially) with the same modulation frequency will interfere each other which leads to sporadically wrong distance information. This can be eliminated if the cameras do not use the same modulation frequency or channel respectively. The difference of the effective modulation frequency of the cameras used should be at least 50 kHz. Refer to Chapter 4.4
- Vertical and horizontal binning allow to combine two neighbor pixels each to one single value. Due to the higher signal level the noise will be reduced and distance accuracy increased. The resolution will be reduced by factor two each.
- The ROI (region of interest) allows to reduce the active pixel field. Only pixels within the selected ROI will be acquired. The “Default ROI” button resets the ROI to full imager size of 320 x 240 pixels.

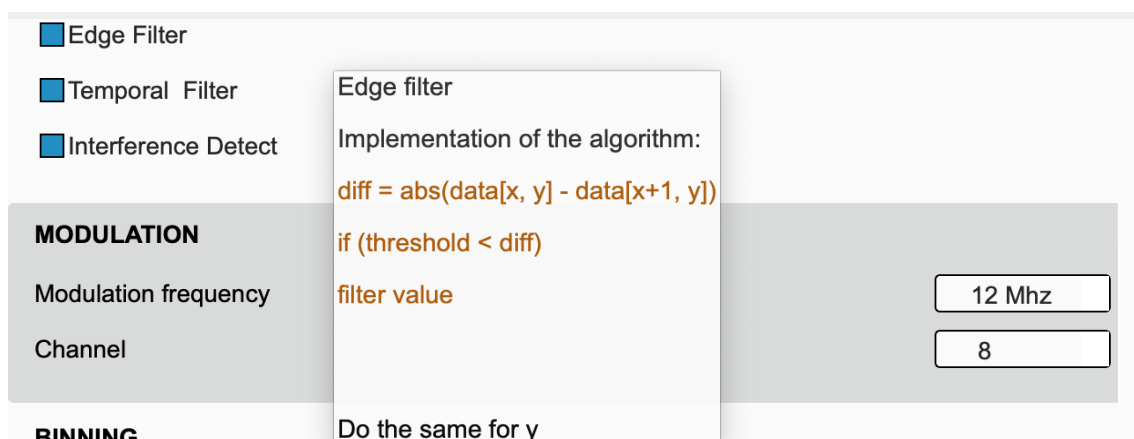

Figure 16: Tooltip examples



### 5.1.2. Play menu

The “Play” menu allows replaying the recorded streams. This is possible in slow motion, original speed or accelerated. A single frame can be searched and selected and the streamed data can be converted to point clouds. This functions of the GUI can be used even if no camera is connected.

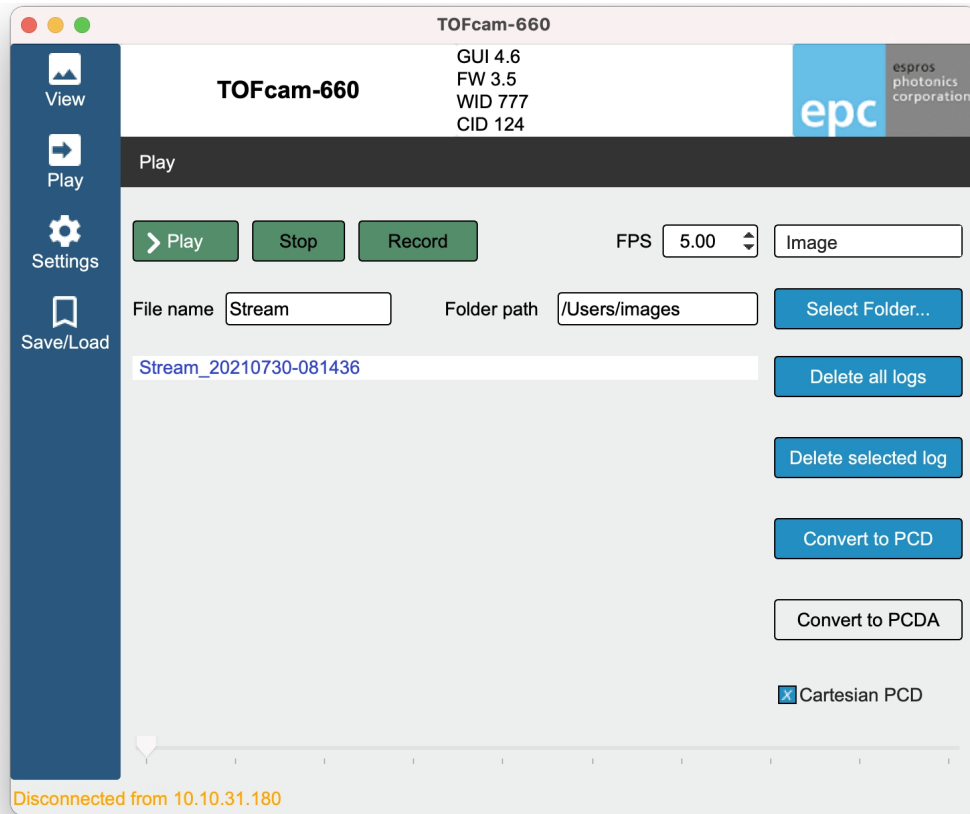

Figure 17: Player controls

- “Play” replays the selected stream with the set frame rate. After changing the selection or pushing the “Stop” button the original frame rate of the recording is used. The “Start” button changes its look to “Pause” after been pushed. Selecting the “Pause” button interrupts the playback and allows to continue from the same point.  
The player can replay the recorded data only with the parameters which has been set during the recording process. This includes also the “Image Type” according to the “View” menu.
- “Stop” aborts the replay, resets the timer to zero and the frame rate to the recording frame rate.
- “Record” streams images according to the parameters set in the “View” menu, refer to Chapter 5.1.1.
- “FPS” sets the acquisition frame rate (or the replay speed respectively). This value is reset by pressing the “Stop” button or by changing the selected log in the list.
- “File name” defines the file name of the log file. An “underline” character separates this name from the current calendar day followed by a “minus” separated time stamp.
- “Folder path” defines the log file location. This path can be changed either directly in the input field or with the “Select Folder” function.
- “Delete all logs” will delete all logs in the selected folder. “Delete selected log” deletes the selected log only. All deletions needs to be confirmed by the user.
- “Convert to PCD” allows converting the recorded binary files to point cloud files which are compatible with point cloud applications such as “Cloud Compare” or “Cloud Compare Viewer”. The converted 3D point cloud has a distance color coding or an amplitude color coding (“Convert to PCDA”).
- The slide bar in the bottom allows manual spooling of the stream forth and back.

### 5.1.3. Streaming files format description

Images are recorded in selected folder and consists of 2 type files:

- A) index ASCII file - <file name>\_<yyyymmddd>-<hhmmss>.idx
- B) binary data files - <file name>\_<yyyymmddd>-<hhmmss>-<index>.bin

Index .idx file contains binary file names in ASCII format.

Image .bin files contains image information in binary format, are using LittleEndian coding and consist of 4 parts:

1. Image header - 25 bytes.
2. User data – optional (comments and addition information. By default no user data).
3. Data – ROI (width \* height) \* 2 or ROI (width \* height) \* 4 (2 bytes per pixel).
4. Additional recorder information - 3 bytes.

BIN image format:

- file size - 4 bytes
- VERSION - 1 byte
- DATA\_TYPE - 2 bytes
- WIDTH - 2 bytes
- HEIGHT - 2 bytes
- ROI\_X0 - 2 bytes
- ROI\_Y0 - 2 bytes
- ROI\_X1 - 2 bytes
- ROI\_Y1 - 2 bytes
- INT\_TIME0 - 2 bytes
- INT\_TIME1 - 2 bytes
- INT\_TIME3 - 2 bytes
- TEMPERATURE - 2 bytes
- OFFSET - 2 bytes (information were begins image data)
- USER\_DATA – x bytes (offset - 25)
- DATA - x bytes (from offset)

TIME\_DIFF – 2 bytes (time stamp difference mS)

DEVICE\_ID – 1 byte (5 for cam660)

Data:

for distance image: (2 bytes ) x width x height - 2 bytes per pixel

for amplitude-distance image: (amplitude 2 bytes + distance 2 bytes ) x width x height - 4 bytes per pixel

### 5.1.4. Live image window

The “Image” window pops-up after a streaming, a replay or a recording has been started from the “View” or the “Play” menu. This window contains the images according to the selected “Image Type”. A recorded stream contains only the data which has been selected during the recording process (distance, amplitude, grayscale or DCS raw data).

With several controls the image can be adjusted to users needs: mirror and rotation functions to adjust the image according to the camera installation position and direction of view, region of interest and all info and scope functions with dedicated information as described in Chapter 5.1.6.

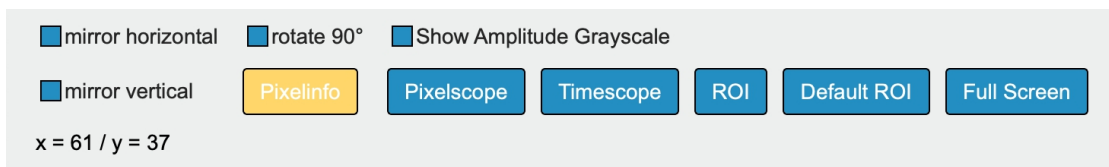

Figure 18: Live image controls

- “mirror horizontal” flips the image horizontally.
- “mirror vertical” flips the image vertically.
- “rotate 90°” rotates the image for 90°.
- The amplitude can be shown as color coded values (default) or as gray-scale.

- The scope functions allow to show some decided information about one single pixel or a selection of many pixels. A description about these information can be found in Chapter 5.1.6. The pixel selection can be deleted with right mouse click or by just doing a new selection.
- “ROI” selects a region of interest by using the left mouse button. “Default ROI” resets the ROI.
- “Full screen” fits the live image window to the screen. To leave the full screen mode press “Esc”.

### 5.1.5. Point cloud

The “Point cloud” window pops-up after a streaming, a replay or a recording has been started from the “View” or the “Play” menu with image type “Point cloud”.

The point cloud can be adjusted according to the camera installation position and direction of view with the mirror and rotation functions. Using the control buttons for default, front, side and top view turns the point cloud into a well defined direction.

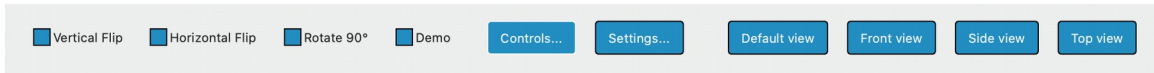

Figure 19: Point cloud window

Using keyboard and mouse allows further controls of the point cloud illustration. Activating the “Settings” allows additional fine tuning of the point cloud visualization.

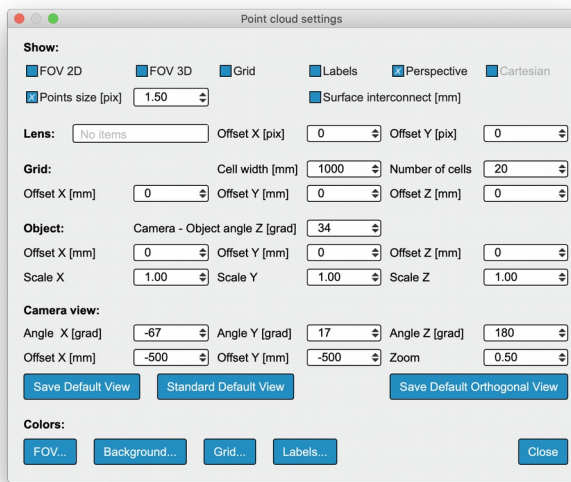

Figure 20: Point Cloud Settings

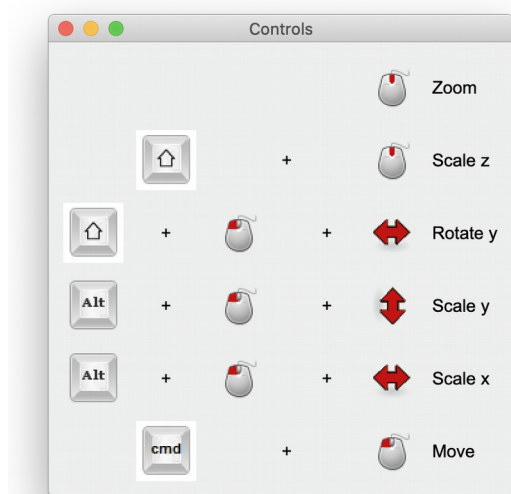

Figure 21: Point Cloud Controls

### 5.1.6. Selective information windows

Pixel data shows the distance values and confidence level of one selected pixel. Minimum, Maximum and Average values from the last 100 measurements as well as standard deviation are shown. Additionally the current frame rate and the chip temperature (temporally filtered) are indicated.

The pixel scope shows the current values of a selected row or an area of selected pixels where each column is indicated separately and all pixels per column are averaged.

The time scope is used to plot the chronologic distance and / or amplitude values of a single pixel or a averaged values of a selected area of the pixel field.

“CopyToClipboard” and “Save” allows to use the current content of the scope fur further use as spreadsheet.

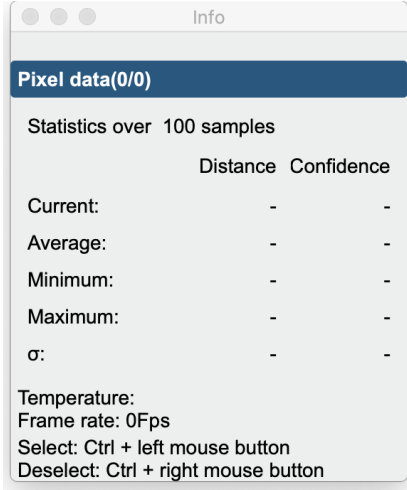

Figure 22: Pixel data

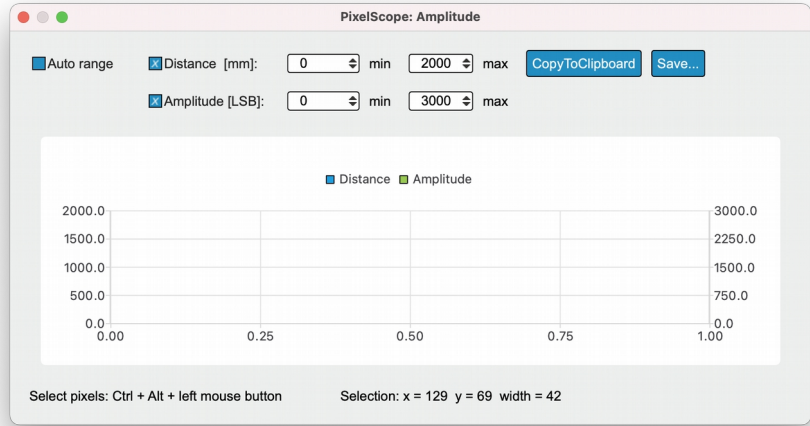

Figure 23: Pixel Scope

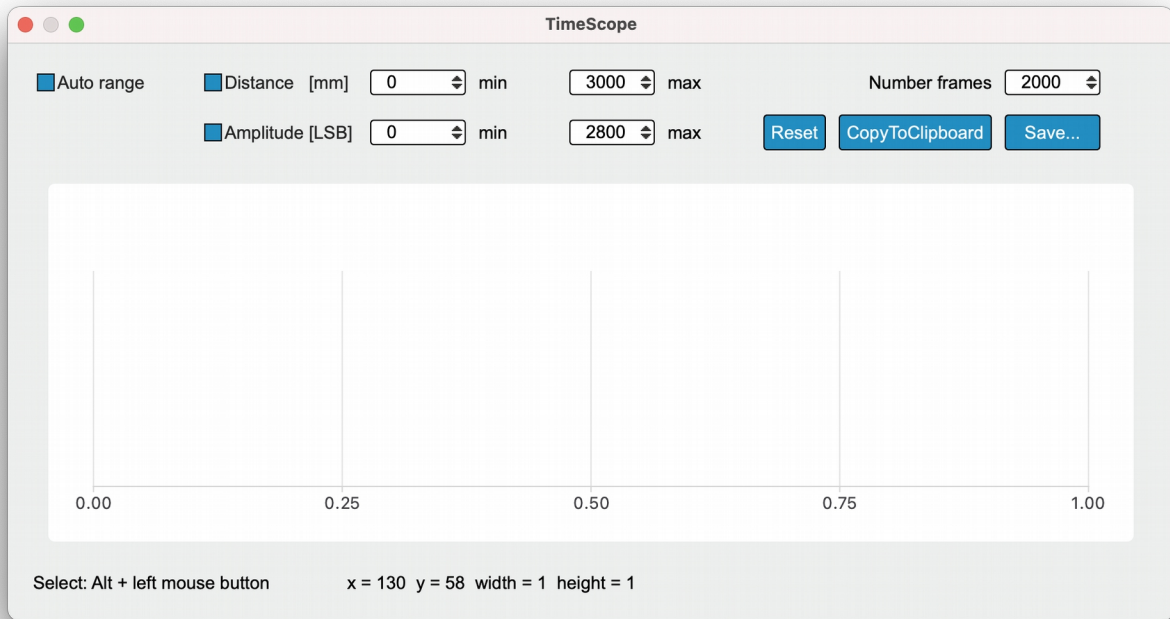

Figure 24: Time Scope

## 5.2. Network settings

It is possible to change the IP address, subnet mask and the gateway of the camera. “Apply IP” permanently stores the current network settings of the TOFcam-660 currently connected.  
If the network settings have been changed accidentally it is possible to reset these values to factory settings. Please refer to Chapter 4.6.3 how to do that.

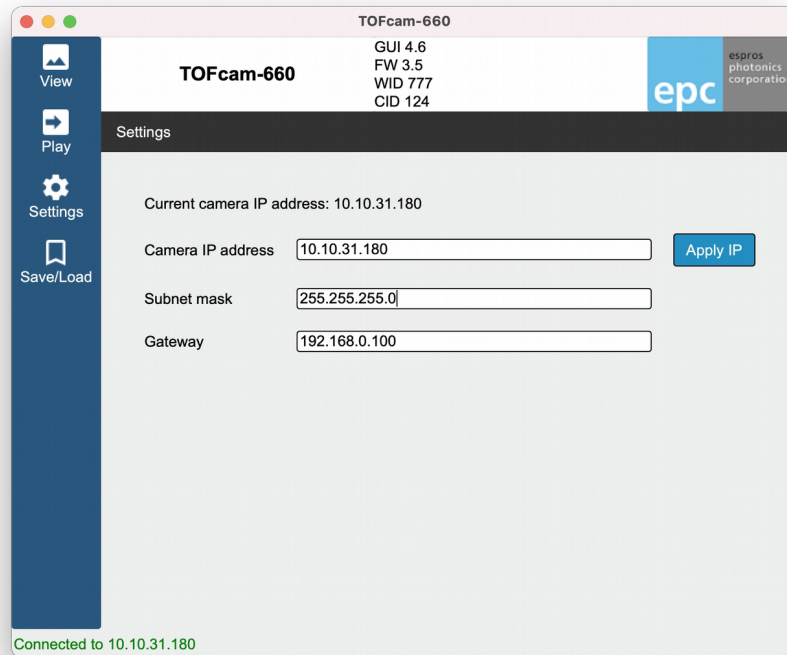

Figure 25: Network settings

## 5.3. Configurations menu

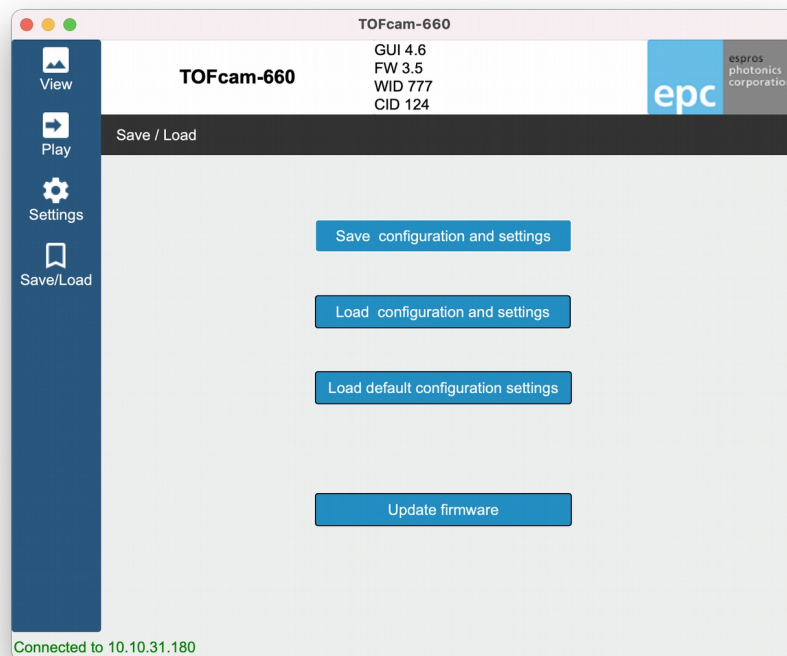

Figure 26: Load and save camera configurations

“Save configuration and settings” from the current camera application to a file.

“Load configuration and settings” from a file stored on the PC into the camera application.

“Load default configuration settings” restores all factory set default values.

“Update firmware” allows to upgrade the firmware according to Chapter 4.8

## 6. Operating the device with a ROS

### 6.1. ROS camera driver

#### 6.1.1. What is ROS?

The Robot Operating System (ROS) is a set of software libraries and tools that help you build robot applications. From drivers to state-of-the-art algorithms and with powerful developer tools, ROS has what is needed for a robotics project. It is all open source (Source: ROS.org). For more details, also refer to ROS.org and ROS Wiki sensors.

#### 6.1.2. Building the ROS driver

System requirement: Linux operating system.

Download the “TOFCAM660\_SW\_Package” from the website [www.espros.com](http://www.espros.com), section Downloads, 02\_Cameras\_and\_Modules.

There is enclosed the “TOFCAM660\_ROS\_driver” file.

Extract zip file for example in `~/projects/` directory

Change current directory:

```
> cd ~/projects/cam660_driver
```

Build a project from the command:

```
> catkin_make
```

Change to the home directory and open the bash-file:

```
> cd ~
```

```
> gedit .bashrc
```

Insert the following line at the end of the bash-file:

```
source ~/projects/cam660_driver/devel/setup.bash
```

Save the file and exit editor.

Log-out and again log-in linux or execute command:

```
> source ~/projects/cam660_driver/devel/setup.bash
```

#### 6.1.3. Running the ROS driver with launch file

Start the ROS with GUI in terminal mode with the following command:

```
roslaunch espros_tof_cam660 camera.launch
```

The ROS tool opens with the different node windows and is ready to use.

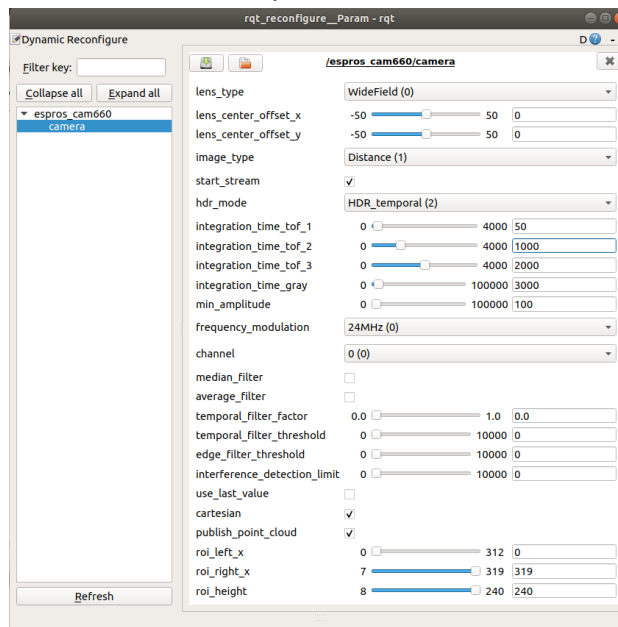

Figure 27: Example of the “dynamic reconfigure” node window

Start the camera operation by changing in the menu the parameter “start\_stream” from false to true.

## 6.2. ROS API

This is the official driver for the ESPROS TOFcam-660. The annotation follows the rules of ROS.org.

### 6.2.1. Start of the node

If you use in terminal mode the APIs only, without GUI:

Start the ROS operating system in a Terminal1 with the command: `roscore`

Start the TOFcam-660 in a Terminal2 with the command: `roslaunch espros_cam660 cam660_node`

### 6.2.2. Published topics

Topic name	ROS msgs file	ROS message type	Function
camera/distance_image_raw	sensor_msgs	Image	Sends the grayscale or amplitude image according the selected image type parameter
camera/amplitude_image_raw	sensor_msgs	Image	Sends the distance image for image type parameters which include distance
camera/dcs_image_raw	sensor_msgs	Image	Sends 4 DCS images
camera/points	sensor_msgs	PointCloud2	Sends the point cloud image for image type parameters which include distance

Table 6: ESPROS ROS topics

### 6.2.3. Dynamically reconfigurable parameters

Refer for details on the dynamically reconfigurable parameters to the enclosed “dynamic\_reconfigure package” or to [http://wiki.ros.org/dynamic\\_reconfigure](http://wiki.ros.org/dynamic_reconfigure).

Parameter	Function	Data format	Default	Reference
~lens_type	Sets the lens field of view 0: WideField 1: StandardField 2: NarrowField	int	0	n/a
~lens_center_offset_x	Sets the offset of lens center relative to sensor center Range: -50 ... 50 pixels	int	0	n/a
~lens_center_offset_y		int	0	n/a
~image_type		Sets the image acquisition type 0: Grayscale 1: Distance 2: Distance and amplitude 3: DCS	int	1
~start_stream	Enables image streaming	bool	True	n/a
~hdr_mode	Sets HDR mode 0: hdr off 1: hdr spatial 2: hdr temporal	int	0	n/a
~integration_time_tof_1	Sets the integration time for distance measurements in microseconds. Range: 1 ... 4'000 µs	int	50	n/a
~integration_time_tof_2		int	400	
~integration_time_tof_3		int	1000	
~integration_time_gray	Sets the integration time for grayscale measurements in microseconds. Range: 0 ... 50'000 µs	int	3000	n/a
~min_amplitude	Sets the amplitude limits. Range 0 ... 2'047 LSB	int	100	
~frequency_modulation	Sets camera frequency modulation. Range: 24 ... 0.75 MHz	int	0	n/a
~channel	Sets camera frequency modulation offset.	int	0	n/a
~median_filter	Enables the spatial median filter for distance filtering	bool	False	n/a
~average_filter	Enables the spatial average filter for distance filtering	bool	False	n/a
~temporal_filter_factor	Sets the factor 'k' of the temporal filter (Kalman). Range: 0.0 ... 1.0	double	0	n/a
~temporal_filter_threshold	Sets the threshold of the temporal filter (Kalman). Range: 0 ... 10000 mm	int	0	n/a
~edge_filter_threshold	Spatial edge filter threshold. Range: 0 ... 10000 mm	int	0	n/a
~temporal_edge_filter_threshold_low	Temporal edge filter low threshold. Range: 0 ... 10000 mm	int	0	n/a
~temporal_edge_filter_threshold_high	Temporal edge filter high threshold. Range: 0 ... 10000 mm	int	0	n/a
~interference_detection_limit	Interference detection threshold. Range 0... 10000 mm	int	0	n/a
~use_last_value	Enables interference detection last value	bool	False	n/a
~cartesian	Enables point cloud cartesian transformation (false = spheric)	bool	True	n/a
~publish_point_cloud	Activates pointCloud2Publisher node to send information (camera/points)	bool	True	Table 6
~roi_left_x	Sets ROI (region of interest) left x position. Range 0 ... 312	int	0	n/a
~roi_right_x	Sets ROI (region of interest) right x position. Range 7 ... 319	int	319	n/a
~roi_height	Sets ROI (region of interest) height. Range 8 ... 240	int	240	n/a

Table 7: ROS parameter table



## 7. Communication interface

### 7.1. Description

The TOFcam-660 is connected to a PC. The TOFcam-660 acts as TCP server: one TCP connection and one UDP connection are opened for command and measurement data as shown in Figure 29. A simple command/answer structure is used: the PC sends a command to the camera and the camera answers it with an acknowledge or an error code over the command connection. As soon as the requested data is ready it is sent over the measurement connection. The data is marked with marker bytes for handshaking. The following ports are used for communication:

- TCP commands connection: 50660
- TCP trace information: 50661
- UDP measurement data connection: 45454

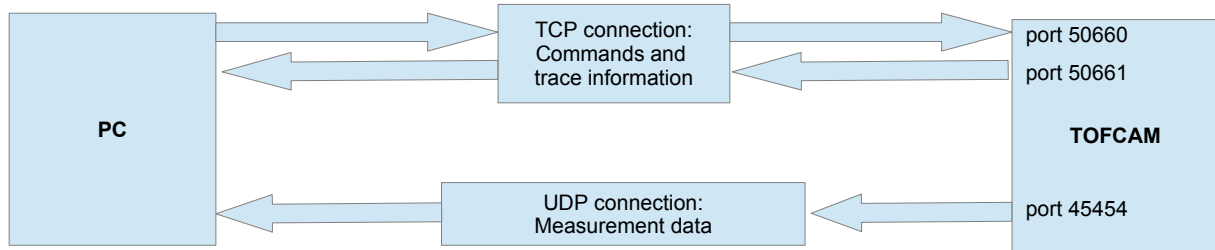

Figure 28: TOFcam-660 host interface

### 7.2. Command Connection (TCP)

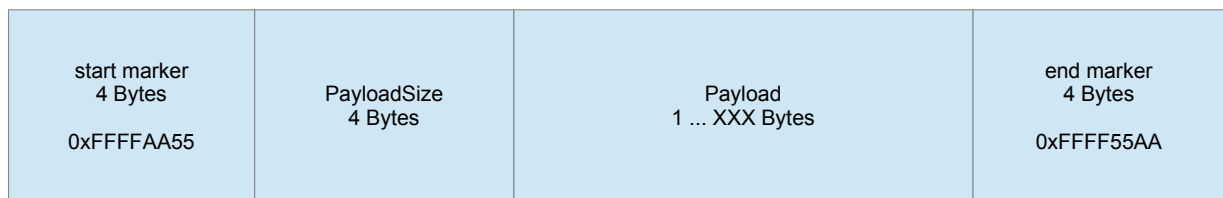

Figure 29: Command/Answer packet composition

Command and answer packets are composed from fields as shown in Figures 29 and . With the marker bytes and the size a reliable detection of the packet boundaries can be achieved.

The payload itself is composed of the following fields:

Command  2 Bytes	Parameters/data size depending on command, see Chapter 8.1	User data:  0 ... 1024 Bytes
------------------------	---	------------------------------------

Figure 30: Command payload fields

Answer  1 Byte	Parameters/data size depending on answer, see Chapter 8.2	User data:  0 ... 1024 Bytes
----------------------	--	------------------------------------

Figure 31: Answer payload fields

User data: Meta-data that will be returned in the measurement data (UDP). Can be used to identify the data.

## 8. Communication

### 8.1. Commands

Command	ID	Parameters	Description										
SET_ROI	0 (0x00)	X0: 2Bytes Y0: 2Bytes X1: 2Bytes Y1: 2Bytes  Example: <table border="1"> <thead> <tr> <th>ID</th> <th>X0</th> <th>Y0</th> <th>X1</th> <th>Y1</th> </tr> </thead> <tbody> <tr> <td>0x00</td> <td>0x00</td> <td>0x00</td> <td>0x00</td> <td>0x00</td> </tr> </tbody> </table> X0 = 0, Y0 = 0, X1 = 319, Y1 = 239	ID	X0	Y0	X1	Y1	0x00	0x00	0x00	0x00	0x00	Set the ROI of the sensor default: x0, Y0 = 0 x1 = 319 y2 = 239
ID	X0	Y0	X1	Y1									
0x00	0x00	0x00	0x00	0x00									
SET_INT_TIMES	1 (0x01)	IntegrationTime3DLow: 2Bytes (< 4000) IntegrationTime3DMid: 2Bytes (< 4000) IntegrationTime3DHigh: 2Bytes (< 4000) IntegrationTimeGrayscale: 2Bytes (< 50000)  Example: <table border="1"> <thead> <tr> <th>ID</th> <th>low integration time 3D image</th> <th>mid integration time 3D image</th> <th>high integration time 3D image</th> <th>integration time grayscale</th> </tr> </thead> <tbody> <tr> <td>0x01</td> <td>0x00</td> <td>0x64</td> <td>0x03</td> <td>0xE8</td> </tr> </tbody> </table> Low integration time 3D: 100us Mid integration time 3D: 1000us High integration time 3D: 2000us Integration time grayscale: 50000us	ID	low integration time 3D image	mid integration time 3D image	high integration time 3D image	integration time grayscale	0x01	0x00	0x64	0x03	0xE8	Set all integration times at once. Unit are $\mu$ s. To switch off an integration time set its value to 0.
ID	low integration time 3D image	mid integration time 3D image	high integration time 3D image	integration time grayscale									
0x01	0x00	0x64	0x03	0xE8									
GET_DISTANCE_AMPLITUDE	2 (0x02)	Stream (true/false): 1Byte <table border="1"> <tr> <td>7Bit unused</td> <td>1Bit Stream</td> </tr> </table>	7Bit unused	1Bit Stream	Get distance and amplitude as stream or single measurement								
7Bit unused	1Bit Stream												
GET_DISTANCE	3 (0x03)	Stream (true/false): 1Byte <table border="1"> <tr> <td>7Bit unused</td> <td>1Bit Stream</td> </tr> </table>	7Bit unused	1Bit Stream	Get distance only as stream or single measurement								
7Bit unused	1Bit Stream												
GET_GRAYSCALE	5 (0x05)	Stream (true/false): 1Byte <table border="1"> <tr> <td>7Bit unused</td> <td>1Bit Stream</td> </tr> </table>	7Bit unused	1Bit Stream	Get grayscale as stream or single measurement								
7Bit unused	1Bit Stream												
GET_DCS	7 (0x07)	Stream (true/false): 1Byte <table border="1"> <tr> <td>7Bit unused</td> <td>1Bit Stream</td> </tr> </table>	7Bit unused	1Bit Stream	Get DCS data as stream or single measurement								
7Bit unused	1Bit Stream												
STOP_STREAM	6 (0x06)	-	Stop streaming										
SYSTEM_RESET	45 (0x2D)	-	Resets the CPU										
SET_MIN_AMPLITUDE	21 (0x15)	MinAmplitude: unsigned 16Bit  Example: <table border="1"> <thead> <tr> <th>ID</th> <th>minAmplitude</th> </tr> </thead> <tbody> <tr> <td>0x01</td> <td>0x01</td> </tr> </tbody> </table> Minimum 3d amplitude = 400LSB	ID	minAmplitude	0x01	0x01	Set the minimal Amplitude [LSB]; the limit where the pixel is set to "low Amplitude"						
ID	minAmplitude												
0x01	0x01												

Table 8: Implemented commands

Command	ID	Parameters	Description								
SET_FILTER	22 (0x16)	TemporalFilter factor: 2Bytes, unsigned 16Bit TemporalFilter threshold: 2Bytes, unsigned 16Bit MedianFilter enabled: 1Byte unsigned AverageFilter enabled: 1Bytes unsigned EdgeDetection threshold: 2Bytes, unsigned 16Bit InterferenceDetection useLastValue: 1Byte unsigned InterferenceDetection limit: 2Bytes, unsigned 16Bit	Set all filter settings at once.  Disable TemporalFilter: Set factor to zero  Disable EdgeDetection: Set threshold to zero  Disable interferenceDetection: Set limit to zero								
SET_MODULATION	23 (0x17)	Frequency: 1Byte Channel: 1Byte Reserved: 1Byte  Example: <table border="1"> <thead> <tr> <th>ID</th> <th>frequency</th> <th>channel</th> <th>reserved</th> </tr> </thead> <tbody> <tr> <td>0x17</td> <td>0x00</td> <td>0x00</td> <td>0x00</td> </tr> </tbody> </table> Modulation frequency = 12MHz, channel = 0	ID	frequency	channel	reserved	0x17	0x00	0x00	0x00	Frequency: 0: 12 MHz 1: 24 MHz 2: 6 MHz 3: 3 MHz 4: 1.5 MHz 5: 0.75 MHz  Channel: 0 ... 15
ID	frequency	channel	reserved								
0x17	0x00	0x00	0x00								
SET_BINNING	24 (0x18)	Binning configuration: 1Byte  Example: <table border="1"> <thead> <tr> <th>ID</th> <th>binning config</th> </tr> </thead> <tbody> <tr> <td>0x18</td> <td>0x00</td> </tr> </tbody> </table> Mode: no binning	ID	binning config	0x18	0x00	0: None 1: Vertical 2: Horizontal 3: Horizontal + Vertical				
ID	binning config										
0x18	0x00										
SET_HDR	25 (0x19)	HDR configuration: 1Byte Response type: acknowledge  Example: <table border="1"> <thead> <tr> <th>ID</th> <th>HDR config</th> </tr> </thead> <tbody> <tr> <td>0x19</td> <td>0x00</td> </tr> </tbody> </table> Mode: no HDR	ID	HDR config	0x19	0x00	0: Off 1: Spatial HDR 2: Temporal HDR				
ID	HDR config										
0x19	0x00										
READ_CHIP_INFORMATION	36 (0x24)	-									
READ_FIRMWARE_RELEASE	37 (0x25)	-									

Table 9: Implemented commands

## 8.2. Responses

Response (1 Byte)	Value	Payload	Description
ANSWER_ACK	0	-	The command has successfully been executed.
ANSWER_NACK	255	-	The command has not been received successfully
ANSWER_ERROR	1	Error number (2Bytes, unsigned 16Bit)	The command could not be executed. The error number contains the reason.
ANSWER_FIRMWARE_RELEASE	2	Firmware Release, 4Bytes, unsigned 16Bit major, unsigned 16Bit minor	
ANSWER_CHIP_INFORMATION	3	Wafer ID, 2Bytes, unsigned 16Bit Chip ID, 2Bytes, unsigned 16Bit	
DATA_DISTANCE_AMPLITUDE		4Bytes per pixel	refer to chapter 9.5 Measurement data
DATA_DISTANCE		2Bytes per pixel	refer to chapter 9.5 Measurement data
DATA_GRAYSCALE		2Bytes per pixel	refer to chapter 9.5 Measurement data
DATA_DCS		2Bytes per pixel x 4DCS	refer to chapter 9.5 Measurement data

Table 10: Implemented Camera Answers

## 9. Measurement Data Connection (UDP)

### 9.1. Packetizing (transport layer)

The data of one measurement (for example distance) is divided (packetized) into as many UDP packets as needed to transport a complete measurement. Each packet contains the information to which measurement it belongs and where in the measurement it belongs to. The receiving application has to concatenate the payload in the single packets to reassemble the original image.

Example: This table shows a measurement containing a total of 30 Bytes, divided in 4 packets:

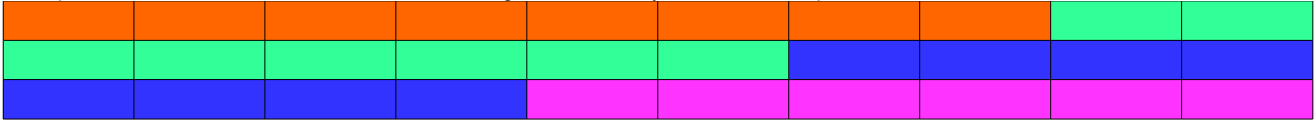

Figure 32: Example of packetizing measurement data

Packet 0: 8Bytes, offset 0

Packet 1: 8Bytes, offset 8

Packet 2: 8Bytes, offset 16

Packet 3: 6Bytes (remaining Bytes), offset 24

In reality the packages are much larger: 20 Bytes header and up to 1400 Bytes Payload.

Each UDP packet is divided into the fields shown in Figure 32. The single fields are explained in Table 11

Element	Description
DataNumber	16Bit unsigned, counter identifying the measurement. Will reset to zero after 65535 measurements
TotalSize	32Bit unsigned, total size in bytes of the data for the whole measurement
PayloadSize	16Bit unsigned, payload size (number of bytes) of the current packet
NumPacket	32Bit unsigned, total number of packets belonging to this measurement
PacketNumber	32Bit unsigned, number of the actual packet of the measurement
Offset	32Bit unsigned, offset (number of bytes) where the payload of this packet must be copied into the receiving buffer
Payload	Payload of the packet as described above

Table 11: UDP Packet fields

## 9.2. Payload (application layer)

After a successful measurement all image data are written into the payload. The payload contains a header with meta-data. This meta-data contains the actual settings of the sensor during image capture.

The payload is structured as shown in Figure 33.



Figure 33: Payload structure

For transmission the payload is chopped into packets as described in chapter 9.1.

## 9.3. Payload Header

The Header is composed from the different fields as shown in figure 34. The single fields are explained in table 12.

Version	Datatype	Width	Height	RoiX0	RoiY0	RoiX1	RoiY1	Int time low	Int time mid	Int time high	Temperature	Offset	user data
1Byte	2Bytes	2Bytes	2Bytes	2Bytes	2Bytes	2Bytes	2Bytes	2Bytes	2Bytes	2Bytes	2Bytes	2Bytes	0 ... 1 kByte

Figure 34: Payload Header

Element	Bytes	Index	Description
Version	1	0	Version of the header structure, starting at 01.
Datatype	2	1	Type of measurement data, see table 13.
Width	2	3	Width of image in pixels
Height	2	5	Height of image in pixels
RoiX0	2	7	Upper left corner in pixels of the region of interest
RoiY0	2	9	Upper left corner in pixels of the region of interest
RoiX1	2	11	lower right corner in pixels of the region of interest
RoiY1	2	13	lower right corner in pixels of the region of interest
Int time 0	2	15	Integration time 0 - low integration time 3D
Int time 1	2	17	Integration time 1 - mid integration time 3D
Int time 2	2	19	Integration time 3 - high integration time 3D
Temperature	2 signed	21	Temperature in [0.01 °C]
DataOffset	2	23	Offset from package start where the measurement data starts (length of header plus user data)
UserData	0 ... 1024	25	Copy of the data, that was transmitted together with the command.

Table 12: Payload header fields

#### 9.4. Data types and format of measurement data

Value	Description	Data				
0	DATA_DISTANCE_AMPLITUDE	4Bytes per pixel: <table border="1"> <tr> <td>4Bit reserved</td> <td>12Bit Amplitude</td> <td>2Bit reserved</td> <td>14Bit Distance 0-16m (1mm/bit)</td> </tr> </table>	4Bit reserved	12Bit Amplitude	2Bit reserved	14Bit Distance 0-16m (1mm/bit)
4Bit reserved	12Bit Amplitude	2Bit reserved	14Bit Distance 0-16m (1mm/bit)			
1	DATA_DISTANCE	2Bytes per pixel: <table border="1"> <tr> <td>2Bit Confidence</td> <td>14Bit Distance (1mm/bit)</td> </tr> </table>	2Bit Confidence	14Bit Distance (1mm/bit)		
2Bit Confidence	14Bit Distance (1mm/bit)					
3	DATA_GRAYSCALE	2Bytes per pixel <table border="1"> <tr> <td>5Bit unused</td> <td>11Bit Grayscale</td> </tr> </table>	5Bit unused	11Bit Grayscale		
5Bit unused	11Bit Grayscale					
4	DATA_DCS	2Bytes per pixel x 4DCS <table border="1"> <tr> <td>4Bit unused</td> <td>12Bit DCS</td> </tr> </table>	4Bit unused	12Bit DCS		
4Bit unused	12Bit DCS					

Table 13: Type of actual measurement data

#### 9.5. Measurement data

Each pixel is coded according to table 14. In cases where the distance or amplitude of a pixel can not be determined, error codes are inserted. Receiving application has to check for these error codes prior to further processing.

Code	Situation	Used for data type
0 ... 64000	Valid value	Distance: distance in mm (12 / 24MHz)
0 ... 2894	Valid value	TOF Amplitude / Grayscale Amplitude: value in LSB
64001	Low Amplitude	Distance
64002	ADC-Overflow	Distance/Amplitude/DCS
64003	Saturation	Distance/Amplitude/Grayscale/DCS
64004	Bad pixel	All images
64007	Interference	Distance/Amplitude
64008	Edge filtered	Distance/Amplitude

Table 14: Coding of pixels

## 10. Maintenance and disposal

### 10.1. Maintenance

The device does not need any maintenance. A functional check is recommended each time the device is taken into operation:

- Check the mounting position and the detection area of the sensor with respect to the operational conditions. Also check that there is no hazardous situation.
- From time to time, clean the windows with a soft towel like you clean your sunglasses. Never use any solvents for cleaning. THE DEVICE CAN BE DESTROYED!

### 10.2. Disposal

Disposal should be done using the most up-to-date recycling technologies for electronic components according to the local regulations and laws. The design and manufacture of the cameras and components are done in compliance with the RoHS legal regulations. Traces of dangerous materials may be found in the electronic components, but not in harmful quantities.



## 11. Addendum

### 11.1. Related documents

Data sheet epc660, ESPROS Photonics Corp.

Book 3D-TOF, A guideline to 3D-TOF sensors that work by ESPROS Photonics Corp. (author Beat Dede Coi et. al.)

### 11.2. Links

[www.espros.com](http://www.espros.com)

[www.pointcloud.org](http://www.pointcloud.org) - Point Cloud Library (PCL)

[www.pdal.io](http://www.pdal.io) - Point Data Abstraction Library (PDAL)

[www.opencv.org](http://www.opencv.org) - OpenCV (OpenSource Computer Vision)

[www.ros.org](http://www.ros.org) - Robot Operating System (ROS)

<http://wiki.ros.org> - ROS documentation

### 11.3. Licenses

We appreciate the use of the following open source or free software in our tools and respect the large amount of work the owners have done:

Tool	Internet address	License holder
Qt-5	<a href="https://www.qt.io">https://www.qt.io</a>	Copyright (C) 2018 The Qt Company
ROS	<a href="http://www.ros.org">www.ros.org</a>	Open Source Robotics Foundation

All rights reserved by the owners.

THIS SOFTWARE IS PROVIDED BY THE COPYRIGHT HOLDERS AND CONTRIBUTORS "AS IS" AND ANY EXPRESS OR IMPLIED WARRANTIES, INCLUDING, BUT NOT LIMITED TO, THE IMPLIED WARRANTIES OF MERCHANTABILITY AND FITNESS FOR A PARTICULAR PURPOSE ARE DISCLAIMED. IN NO EVENT SHALL THE COPYRIGHT HOLDER OR CONTRIBUTORS BE LIABLE FOR ANY DIRECT, INDIRECT, INCIDENTAL, SPECIAL, EXEMPLARY, OR CONSEQUENTIAL DAMAGES (INCLUDING, BUT NOT LIMITED TO, PROCUREMENT OF SUBSTITUTE GOODS OR SERVICES; LOSS OF USE, DATA, OR PROFITS; OR BUSINESS INTERRUPTION) HOWEVER CAUSED AND ON ANY THEORY OF LIABILITY, WHETHER IN CONTRACT, STRICT LIABILITY, OR TORT (INCLUDING NEGLIGENCE OR OTHERWISE) ARISING IN ANY WAY OUT OF THE USE OF THIS SOFTWARE, EVEN IF ADVISED OF THE POSSIBILITY OF SUCH DAMAGE.

## 12. IMPORTANT NOTICE

ESPROS Photonics AG and its subsidiaries (ESPROS) reserve the right to make corrections, modifications, enhancements, improvements, and other changes to its products, documentations and services at any time and to discontinue any product or service without notice. Customers should obtain the latest relevant information before placing orders and should verify that such information is current and complete. All products are sold subject to ESPROS' terms and conditions of sale supplied at the time of order acknowledgment.

ESPROS warrants performance of its hardware products to the specifications applicable at the time of sale in accordance with ESPROS' standard warranty. Testing and other quality control techniques are used to the extent ESPROS deems necessary to support this warranty. Except where mandated by government requirements, testing of all parameters of each product is not necessarily performed.

ESPROS assumes no liability for applications assistance or customer product design. Customers are responsible for their products and applications using ESPROS components. To minimize the risks associated with customer products and applications, customers should provide adequate design and operating safeguards.

ESPROS does not warrant or represent that any license, either express or implied, is granted under any ESPROS patent right, copyright, mask work right, or other ESPROS intellectual property right relating to any combination, machine, or process in which ESPROS products or services are used. Information published by ESPROS regarding third-party products or services does not constitute a license from ESPROS to use such products or services or a warranty or endorsement thereof. Use of such information may require a license from a third party under the patents or other intellectual property of the third party, or a license from ESPROS under the patents or other intellectual property of ESPROS.

Resale of ESPROS products or services with statements different from or beyond the parameters stated by ESPROS for that product or service voids all express and any implied warranties for the associated ESPROS product or service. ESPROS is not responsible or liable for any such statements.

ESPROS products are not authorized for use in safety-critical applications (such as life support) where a failure of the ESPROS product would reasonably be expected to cause severe personal injury or death, unless officers of the parties have executed an agreement specifically governing such use. Buyers represent that they have all necessary expertise in the safety and regulatory ramifications of their applications, and acknowledge and agree that they are solely responsible for all legal, regulatory and safety-related requirements concerning their products and any use of ESPROS products in such safety-critical applications, notwithstanding any applications-related information or support that may be provided by ESPROS. Further, Buyers must fully indemnify ESPROS and its representatives against any damages arising out of the use of ESPROS products in such safety-critical applications.

ESPROS products are neither designed nor intended for use in military/aerospace applications or environments unless the ESPROS products are specifically designated by ESPROS as military-grade. Only products designated by ESPROS as military-grade meet military specifications. Buyers acknowledge and agree that any such use of ESPROS products which ESPROS has not designated as military-grade is solely at the Buyer's risk, and that they are solely responsible for compliance with all legal and regulatory requirements in connection with such use.

ESPROS products are neither designed nor intended for use in automotive applications or environments unless the specific ESPROS products are designated by ESPROS as compliant with ISO/TS 16949 requirements. Buyers acknowledge and agree that, if they use any non-designated products in automotive applications, ESPROS will not be responsible for any failure to meet such requirements.