

FEATURES

4-channel, 16-bit resolution ADC

2 track-and-hold amplifiers

Throughput

1 MSPS (normal mode)

888 kSPS (impulse mode)

Analog input voltage range: 0 V to 5 V

No pipeline delay

Parallel and serial 5 V/3 V interface

SPI®/QSPI™/MICROWIRE™/DSP compatible

Single 5 V supply operation

Power dissipation

120 mW typical

2.6 mW at 10 kSPS

48-lead frame chip scale package (LFCSP)

Pin-to-pin compatible with the AD7654

Low cost

Supports defense and aerospace applications (AQEC standard)

Military temperature range (–55°C to +125°C)

Controlled manufacturing baseline

Product change notification

Qualification data available on request

APPLICATIONS

AC motor control

3-phase power control

4-channel data acquisition

Uninterrupted power supplies

Communications

GENERAL DESCRIPTION

The AD7655-EP is a low cost, simultaneous sampling, dual-channel, 16-bit, charge redistribution SAR, analog-to-digital converter that operates from a single 5 V power supply. It contains two low noise, wide bandwidth, track-and-hold amplifiers that allow simultaneous sampling, a high speed 16-bit sampling ADC, an internal conversion clock, error correction circuits, and both serial and parallel system interface ports. Each track-and-hold has a multiplexer in front to provide a 4-channel input ADC. The A0 multiplexer control input allows the choice of simultaneously sampling input pairs INA1/INB1 (A0 = low) or INA2/INB2 (A0 = high). The part features a very high sampling rate mode (normal) and, for low

FUNCTIONAL BLOCK DIAGRAM

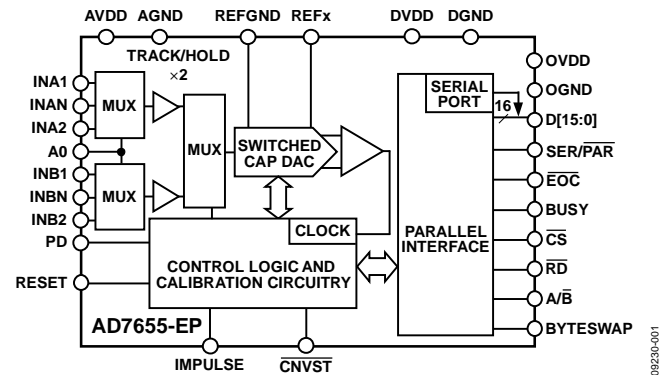

Figure 1.

Table 1. PuSAR® Selection

Type/kSPS	100 to 250	500 to 570	800 to 1000	>1000
Pseudo Differential	AD7660/ AD7661	AD7650/ AD7652 AD7664/ AD7666	AD7653 AD7667	
True Bipolar				
True Differential	AD7663 AD7675	AD7665 AD7676	AD7671 AD7677	AD7621 AD7623
18 Bit	AD7678	AD7679	AD7674	AD7641
Multichannel/ Simultaneous		AD7654	AD7655	

power applications, a reduced power mode (impulse) where the power is scaled with the throughput. Operation is specified from –55°C to +125°C.

Full details about this enhanced product are available in the [AD7655](#) data sheet, which should be consulted in conjunction with this data sheet.

PRODUCT HIGHLIGHTS

- Multichannel ADC.**
The AD7655-EP features 4-channel inputs with two sample-and-hold circuits that allow simultaneous sampling.
- Fast Throughput.**
The AD7655-EP is a 1 MSPS, charge redistribution, 16-bit SAR ADC with internal error correction circuitry.
- Single-Supply Operation.**
The AD7655-EP operates from a single 5 V supply. In impulse mode, its power dissipation decreases with throughput.
- Serial or Parallel Interface.**
Versatile parallel or 2-wire serial interface arrangements are compatible with both 3 V and 5 V logic.

Rev. B

[Document Feedback](#)

Information furnished by Analog Devices is believed to be accurate and reliable. However, no responsibility is assumed by Analog Devices for its use, nor for any infringements of patents or other rights of third parties that may result from its use. Specifications subject to change without notice. No license is granted by implication or otherwise under any patent or patent rights of Analog Devices. Trademarks and registered trademarks are the property of their respective owners.

TABLE OF CONTENTS

Features	1	Timing Specifications	5
Applications	1	Absolute Maximum Ratings	7
General Description	1	ESD Caution.....	7
Functional Block Diagram	1	Pin Configurations and Function Descriptions	8
Product Highlights	1	Outline Dimensions	11
Revision History	2	Ordering Guide	12
Specifications.....	3		

REVISION HISTORY

1/2018—Rev. A to Rev. B

Added CP-48-4 Package	Universal
Change to General Description Section	1
Added Figure 5; Renumbered Sequentially	8
Changes to Figure 4 and Table 6.....	8
Updated Outline Dimensions	11
Changes to Ordering Guide	11

2/2011—Rev. 0 to Rev. A

Removed LQFP from Features Section	1
Removed Internal Power Dissipation (700 mW) from Table 5.....	7

7/2010—Revision 0: Initial Version

SPECIFICATIONS

AVDD = DVDD = 5 V, OVDD = 2.7 V to 5.25 V; V_{REF} = 2.5 V; all specifications T_{MIN} to T_{MAX}, unless otherwise noted.

Table 2.

Parameter	Conditions	Min	Typ	Max	Unit
RESOLUTION		16			Bits
ANALOG INPUT					
Voltage Range	V _{INx} – V _{INxN}	0		2 V _{REF}	V
Common-Mode Input Voltage	V _{INxN}	–0.1		+0.5	V
Analog Input CMRR	f _{IN} = 100 kHz		55		dB
Input Current	1 MSPS throughput		45		μA
Input Impedance					
THROUGHPUT SPEED					
Complete Cycle (2 Channels)	Normal mode			2	μs
Throughput Rate	Normal mode	0		1	MSPS
Complete Cycle (2 Channels)	Impulse mode			2.25	μs
Throughput Rate	Impulse mode	0		888	kSPS
DC ACCURACY					
Integral Linearity Error ¹		–6		+6	LSB ²
No Missing Codes		15			Bits
Transition Noise			0.8		LSB
Full-Scale Error	T _{MIN} to T _{MAX}		±0.25	±0.5	% of FSR
Full-Scale Error Drift			±2		ppm/°C
Unipolar Zero Error	T _{MIN} to T _{MAX}			±0.25	% of FSR
Unipolar Zero Error Drift			±0.8		ppm/°C
Power Supply Sensitivity	AVDD = 5 V ± 5%		±0.8		LSB
AC ACCURACY					
Signal-to-Noise	f _{IN} = 100 kHz		86		dB ³
Spurious-Free Dynamic Range	f _{IN} = 100 kHz		98		dB
Total Harmonic Distortion	f _{IN} = 100 kHz		–96		dB
Signal-to-Noise and Distortion	f _{IN} = 100 kHz		86		dB
Channel-to-Channel Isolation	f _{IN} = 100 kHz, –60 dB input		30		dB
–3 dB Input Bandwidth	f _{IN} = 100 kHz		–92		dB
			10		MHz
SAMPLING DYNAMICS					
Aperture Delay			2		ns
Aperture Delay Matching			30		ps
Aperture Jitter			5		ps rms
Transient Response	Full-scale step			250	ns
REFERENCE					
External Reference Voltage Range		2.3	2.5	AVDD/2	V
External Reference Current Drain	1 MSPS throughput		180		μA
DIGITAL INPUTS					
Logic Levels					
V _{IL}		–0.3		+0.8	V
V _{IH}		+2.0		DVDD + 0.3	V
I _{IL}		–1		+1	μA
I _{IH}		–1		+1	μA
DIGITAL OUTPUTS					
Data Format ⁴					
Pipeline Delay ⁵					
V _{OL}	I _{SINK} = 1.6 mA			0.4	V
V _{OH}	I _{SOURCE} = –500 μA	OVDD – 0.2			V

Parameter	Conditions	Min	Typ	Max	Unit
POWER SUPPLIES					
Specified Performance					
AVDD		4.75	5	5.25	V
DVDD		4.75	5	5.25	V
OVDD		2.7		5.25 ⁶	V
Operating Current ⁷					
AVDD	1 MSPS throughput		15.5		mA
DVDD			8.5		mA
OVDD			100		μA
Power Dissipation					
	1 MSPS throughput ⁷		120	135	mW
	20 kSPS throughput ⁸		2.6		mW
	888 kSPS throughput ⁸		114	125	mW
TEMPERATURE RANGE⁹					
Specified Performance					
	T _{MIN} to T _{MAX}	-55		+125	°C

¹ Linearity is tested using endpoints, not best fit.

² LSB means least significant bit. With the 0 V to 5 V input range, 1 LSB is 76.294 μV.

³ All specifications in dB are referred to as full-scale input, FS. Tested with an input signal at 0.5 dB below full scale unless otherwise specified.

⁴ Parallel or serial 16 bit.

⁵ Conversion results are available immediately after completed conversion.

⁶ The maximum should be the minimum of 5.25 V and DVDD + 0.3 V.

⁷ In normal mode; tested in parallel reading mode.

⁸ In impulse mode; tested in parallel reading mode.

⁹ Consult sales for extended temperature range.

TIMING SPECIFICATIONSAVDD = DVDD = 5 V, OVDD = 2.7 V to 5.25 V; V_{REF} = 2.5 V; all specifications T_{MIN} to T_{MAX}, unless otherwise noted.

Table 3.

Parameter	Symbol	Min	Typ	Max	Unit
CONVERSION AND RESET					
Convert Pulse Width	t ₁	5			ns
Time Between Conversions (Normal Mode/Impulse Mode)	t ₂	2/2.25			μs
$\overline{\text{CNVST}}$ Low to BUSY High Delay	t ₃			32	ns
BUSY High All Modes Except in Master Serial Read After Convert Mode (Normal Mode/Impulse Mode)	t ₄			1.75/2	μs
Aperture Delay	t ₅		2		ns
End of Conversions to BUSY Low Delay	t ₆	10			ns
Conversion Time (Normal Mode/Impulse Mode)	t ₇			1.75/2	μs
Acquisition Time	t ₈	250			ns
RESET Pulse Width	t ₉	10			ns
$\overline{\text{CNVST}}$ Low to $\overline{\text{EOC}}$ High Delay	t ₁₀			30	ns
$\overline{\text{EOC}}$ High for Channel A Conversion (Normal Mode/Impulse Mode)	t ₁₁			1/1.25	μs
$\overline{\text{EOC}}$ Low after Channel A Conversion	t ₁₂	45			ns
$\overline{\text{EOC}}$ High for Channel B Conversion	t ₁₃			0.75	μs
Channel Selection Setup Time	t ₁₄	250			ns
Channel Selection Hold Time	t ₁₅			30	ns
PARALLEL INTERFACE MODES					
$\overline{\text{CNVST}}$ Low to DATA Valid Delay	t ₁₆			1.75/2	μs
DATA Valid to BUSY Low Delay	t ₁₇	14			ns
Bus Access Request to DATA Valid	t ₁₈			40	ns
Bus Relinquish Time	t ₁₉	5		15	ns
A/B Low to Data Valid Delay	t ₂₀			40	ns
MASTER SERIAL INTERFACE MODES					
$\overline{\text{CS}}$ Low to SYNC Valid Delay	t ₂₁			10	ns
$\overline{\text{CS}}$ Low to Internal SCLK Valid Delay ¹	t ₂₂			10	ns
$\overline{\text{CS}}$ Low to SDOUT Delay	t ₂₃			10	ns
$\overline{\text{CNVST}}$ Low to SYNC Delay, Read During Convert (Normal Mode/Impulse Mode)	t ₂₄		250/500		ns
SYNC Asserted to SCLK First Edge Delay	t ₂₅	3			ns
Internal SCK Period ²	t ₂₆	23		40	ns
Internal SCLK High ²	t ₂₇	12			ns
Internal SCLK Low ²	t ₂₈	7			ns
SDOUT Valid Setup Time ²	t ₂₉	4			ns
SDOUT Valid Hold Time ²	t ₃₀	2			ns
SCLK Last Edge to SYNC Delay ²	t ₃₁	1			ns
$\overline{\text{CS}}$ High to SYNC High-Z	t ₃₂			10	ns
$\overline{\text{CS}}$ High to Internal SCLK High-Z	t ₃₃			10	ns
$\overline{\text{CS}}$ High to SDOUT High-Z	t ₃₄			10	ns
BUSY High in Master Serial Read after Convert ²	t ₃₅		See Table 4		
$\overline{\text{CNVST}}$ Low to SYNC Asserted Delay (Normal Mode/Impulse Mode)	t ₃₆		0.75/1		μs
SYNC Deasserted to BUSY Low Delay	t ₃₇		25		ns

Parameter	Symbol	Min	Typ	Max	Unit
SLAVE SERIAL INTERFACE MODES					
External SCLK Setup Time	t ₃₈	5			ns
External SCLK Active Edge to SDOUT Delay	t ₃₉	3		18	ns
SDIN Setup Time	t ₄₀	5			ns
SDIN Hold Time	t ₄₁	5			ns
External SCLK Period	t ₄₂	25			ns
External SCLK High	t ₄₃	10			ns
External SCLK Low	t ₄₄	10			ns

¹ In serial interface modes, the SYNC, SCLK, and SDOUT timings are defined with a maximum load C_L of 10 pF; otherwise C_L is 60 pF maximum.

² In serial master read during convert mode. See Table 4 for serial master read after convert mode.

Table 4. Serial Clock Timings in Master Read After Convert

DIVSCLK[1]	Symbol	0	0	1	1	Unit
DIVSCLK[0]		0	1	0	1	
SYNC to SCLK First Edge Delay Minimum	t ₂₅	3	17	17	17	ns
Internal SCLK Period Minimum	t ₂₆	25	50	100	200	ns
Internal SCLK Period Typical	t ₂₆	40	70	140	280	ns
Internal SCLK High Minimum	t ₂₇	12	22	50	100	ns
Internal SCLK Low Minimum	t ₂₈	7	21	49	99	ns
SDOUT Valid Setup Time Minimum	t ₂₉	4	18	18	18	ns
SDOUT Valid Hold Time Minimum	t ₃₀	2	4	30	80	ns
SCLK Last Edge to SYNC Delay Minimum	t ₃₁	1	3	30	80	ns
Busy High Width Maximum (Normal)	t ₃₅	3.25	4.25	6.25	10.75	μs
Busy High Width Maximum (Impulse)	t ₃₅	3.5	4.5	6.5	11	μs

ABSOLUTE MAXIMUM RATINGS

Table 5.

Parameter	Values
Analog Input INAx, INBx, REFx, INxN, REFGND	AVDD + 0.3 V to AGND – 0.3 V
Ground Voltage Differences AGND, DGND, OGNND	±0.3 V
Supply Voltages AVDD, DVDD, OVDD	–0.3 V to +7 V
AVDD to DVDD, AVDD to OVDD	±7 V
DVDD to OVDD	–0.3 V to +7 V
Digital Inputs	–0.3 V to DVDD + 0.3 V
Internal Power Dissipation	2.5 W
Junction Temperature	150°C
Storage Temperature Range ¹	–65°C to +150°C
Lead Temperature Range (Soldering 10 sec)	300°C

¹ Specification is for device in free air: 48-lead LFCSP, $\theta_{JA} = 26^{\circ}\text{C}/\text{W}$.

Stresses at or above those listed under Absolute Maximum Ratings may cause permanent damage to the product. This is a stress rating only; functional operation of the product at these or any other conditions above those indicated in the operational section of this specification is not implied. Operation beyond the maximum operating conditions for extended periods may affect product reliability.

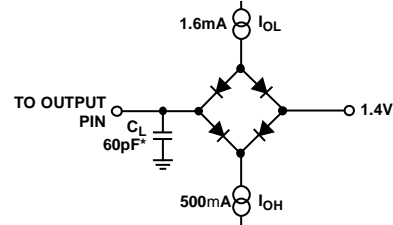

*IN SERIAL INTERFACE MODES, THE SYNC, SCLK, AND SDOOUT TIMINGS ARE DEFINED WITH A MAXIMUM LOAD C_L OF 10pF; OTHERWISE, THE LOAD IS 60pF MAXIMUM.

09P230-002

Figure 2. Load Circuit for Digital Interface Timing

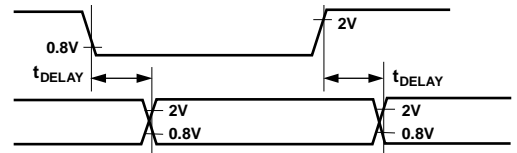

09P230-003

Figure 3. Voltage Reference Levels for Timing

ESD CAUTION



ESD (electrostatic discharge) sensitive device. Charged devices and circuit boards can discharge without detection. Although this product features patented or proprietary protection circuitry, damage may occur on devices subjected to high energy ESD. Therefore, proper ESD precautions should be taken to avoid performance degradation or loss of functionality.

PIN CONFIGURATIONS AND FUNCTION DESCRIPTIONS

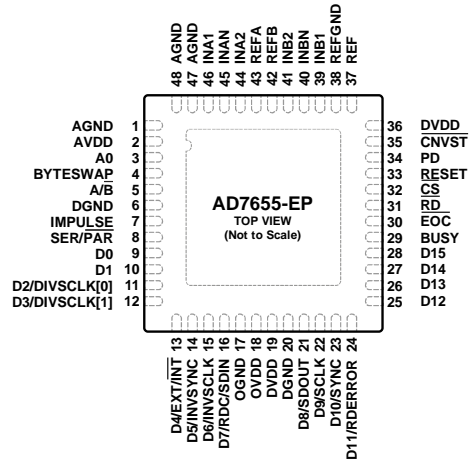
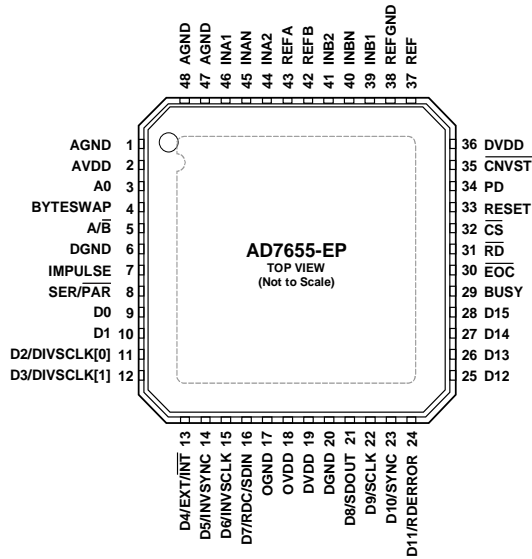

NOTES
1. EXPOSED PAD. THE EPAD IS CONNECTED TO GROUND; HOWEVER, THIS CONNECTION IS NOT REQUIRED TO MEET SPECIFIED PERFORMANCE.

Figure 4. 48-Lead LFCSP (CP-48-1)

NOTES
1. EXPOSED PAD. THE EPAD IS CONNECTED TO GROUND; HOWEVER, THIS CONNECTION IS NOT REQUIRED TO MEET SPECIFIED PERFORMANCE.

Figure 5. 48-Lead LFCSP (CP-48-4)

Table 6. Pin Function Descriptions

Pin No.	Mnemonic	Type ¹	Description
1, 47, 48	AGND	P	Analog Power Ground Pin.
2	AVDD	P	Input Analog Power Pin. Nominally 5 V.
3	A0	DI	Multiplexer Select. When LOW, the analog inputs INA1 and INB1 are sampled simultaneously, then converted. When HIGH, the analog inputs INA2 and INB2 are sampled simultaneously, then converted.
4	BYTESWAP	DI	Parallel Mode Selection (8 Bit, 16 Bit). When LOW, the LSB is output on D[7:0] and the MSB is output on D[15:8]. When HIGH, the LSB is output on D[15:8] and the MSB is output on D[7:0].
5	A/B	DI	Data Channel Selection. In parallel mode, when LOW, the data from Channel B is read. When HIGH, the data from Channel A is read. In serial mode, when HIGH, Channel A is output first followed by Channel B. When LOW, Channel B is output first followed by Channel A.
6, 20	DGND	P	Digital Power Ground.
7	IMPULSE	DI	Mode Selection. When HIGH, this input selects a reduced power mode. In this mode, the power dissipation is approximately proportional to the sampling rate.
8	SER/PAR	DI	Serial/Parallel Selection Input. When LOW, the parallel port is selected; when HIGH, the serial interface mode is selected and some bits of the DATA bus are used as a serial port.
9, 10	D[0:1]	DO	Bit 0 and Bit 1 of the Parallel Port Data Output Bus. When SER/PAR is HIGH, these outputs are in high impedance.
11, 12	D[2:3] or DIVSCLK[0:1]	DI/O	When SER/PAR is LOW, these outputs are used as Bit 2 and Bit 3 of the Parallel Port Data Output Bus. When SER/PAR is HIGH, EXT/INT is LOW, and RDC/SDIN is LOW, which is the serial master read after convert mode. These inputs, part of the serial port, are used to slow down the internal serial clock that clocks the data output. In the other serial modes, these inputs are not used.
13	D[4] or EXT/INT	DI/O	When SER/PAR is LOW, this output is used as Bit 4 of the Parallel Port Data Output Bus. When SER/PAR is HIGH, this input, part of the serial port, is used as a digital select input for choosing the internal or an external data clock called, respectively, master and slave mode. With EXT/INT tied LOW, the internal clock is selected on SCLK output. With EXT/INT set to a logic HIGH, output data is synchronized to an external clock signal connected to the SCLK input.

Pin No.	Mnemonic	Type ¹	Description
14	D[5] or INVSYNC	DI/O	When SER/ $\overline{\text{PAR}}$ is LOW, this output is used as Bit 5 of the Parallel Port Data Output Bus. When SER/ $\overline{\text{PAR}}$ is HIGH, this input, part of the serial port, is used to select the active state of the SYNC signal in Master modes. When LOW, SYNC is active HIGH. When HIGH, SYNC is active LOW.
15	D[6] or INVSCCLK	DI/O	When SER/ $\overline{\text{PAR}}$ is LOW, this output is used as Bit 6 of the parallel port data output bus. When SER/ $\overline{\text{PAR}}$ is HIGH, this input, part of the serial port, is used to invert the SCLK signal. It is active in both master and slave modes.
16	D[7] or RDC/SDIN	DI/O	When SER/ $\overline{\text{PAR}}$ is LOW, this output is used as Bit 7 of the Parallel Port Data Output Bus. When SER/ $\overline{\text{PAR}}$ is HIGH, this input, part of the serial port, is used as either an external data input or a read mode selection input, depending on the state of EXT/ $\overline{\text{INT}}$. When EXT/ $\overline{\text{INT}}$ is HIGH, RDC/SDIN can be used as a data input to daisy-chain the conversion results from two or more ADCs onto a single SDOOUT line. The digital data level on SDIN is output on SDOOUT with a delay of 32 SCLK periods after the initiation of the read sequence. When EXT/ $\overline{\text{INT}}$ is LOW, RDC/SDIN is used to select the read mode. When RDC/SDIN is HIGH, the previous data is output on SDOOUT during conversion. When RDC/SDIN is LOW, the data can be output on SDOOUT only when the conversion is complete.
17	OGND	P	Input/Output Interface Digital Power Ground.
18	OVDD	P	Input/Output Interface Digital Power. Nominally at the same supply as the supply of the host interface (5 V or 3 V).
19, 36	DVDD	P	Digital Power. Nominally at 5 V.
21	D[8] or SDOUT	DO	When SER/ $\overline{\text{PAR}}$ is LOW, this output is used as Bit 8 of the Parallel Port Data Output Bus. When SER/ $\overline{\text{PAR}}$ is HIGH, this output, part of the serial port, is used as a serial data output synchronized to SCLK. Conversion results are stored in a 32-bit on-chip register. The AD7655-EP provides the two conversion results, MSB first, from its internal shift register. The order of channel outputs is controlled by A/B. In serial mode, when EXT/ $\overline{\text{INT}}$ is LOW, SDOUT is valid on both edges of SCLK. In serial mode, when EXT/ $\overline{\text{INT}}$ is HIGH: If INVSCCLK is LOW, SDOUT is updated on the SCLK rising edge and valid on the next falling edge. If INVSCCLK is HIGH, SDOUT is updated on the SCLK falling edge and valid on the next rising edge.
22	D[9] or SCLK	DI/O	When SER/ $\overline{\text{PAR}}$ is LOW, this output is used as Bit 9 of the Parallel Port Data Output Bus. When SER/ $\overline{\text{PAR}}$ is HIGH, this pin, part of the serial port, is used as a serial data clock input or output, depends upon the logic state of the EXT/ $\overline{\text{INT}}$ pin. The active edge where the data SDOUT is updated depends on the logic state of the INVSCCLK pin.
23	D[10] or SYNC	DO	When SER/ $\overline{\text{PAR}}$ is LOW, this output is used as Bit 10 of the Parallel Port Data Output Bus. When SER/ $\overline{\text{PAR}}$ is HIGH, this output, part of the serial port, is used as a digital output frame synchronization for use with the internal data clock (EXT/ $\overline{\text{INT}}$ = Logic LOW). When a read sequence is initiated and INVSYNC is LOW, SYNC is driven HIGH and frames SDOUT. After the first channel is output, SYNC is pulsed LOW. When a read sequence is initiated and INVSYNC is HIGH, SYNC is driven LOW and remains LOW while SDOUT output is valid. After the first channel is output, SYNC is pulsed HIGH.
24	D[11] or RDERROR	DO	When SER/ $\overline{\text{PAR}}$ is LOW, this output is used as Bit 11 of the Parallel Port Data Output Bus. When SER/ $\overline{\text{PAR}}$ is HIGH and EXT/ $\overline{\text{INT}}$ is HIGH, this output, part of the serial port, is used as an incomplete read error flag. In slave mode, when a data read is started but not complete when the following conversion is complete, the current data is lost and RDERROR is pulsed HIGH.
25 to 28	D[12:15]	DO	Bit 12 to Bit 15 of the parallel port data output bus. When SER/ $\overline{\text{PAR}}$ is HIGH, these outputs are in high impedance.
29	BUSY	DO	Busy Output. Transitions HIGH when a conversion is started and remains HIGH until the two conversions are complete and the data is latched into the on-chip shift register. The falling edge of BUSY can be used as a data ready clock signal.
30	$\overline{\text{EOC}}$	DO	End of Convert Output. Goes LOW at each channel conversion.
31	$\overline{\text{RD}}$	DI	Read Data. When $\overline{\text{CS}}$ and $\overline{\text{RD}}$ are both LOW, the interface parallel or serial output bus is enabled.
32	$\overline{\text{CS}}$	DI	Chip Select. When $\overline{\text{CS}}$ and $\overline{\text{RD}}$ are both LOW, the interface parallel or serial output bus is enabled. $\overline{\text{CS}}$ is also used to gate the external serial clock.
33	RESET	DI	Reset Input. When set to a logic HIGH, reset the AD7655-EP. Current conversion, if any, is aborted. If not used, this pin could be tied to DGND.
34	PD	DI	Power-Down Input. When set to a logic HIGH, power consumption is reduced and conversions are inhibited after the current conversion is completed.

Pin No.	Mnemonic	Type ¹	Description
35	$\overline{\text{CNVST}}$	DI	Start Conversion. A falling edge on $\overline{\text{CNVST}}$ puts the internal sample-and-hold into the hold state and initiates a conversion. In impulse mode (IMPULSE = HIGH), if $\overline{\text{CNVST}}$ is held LOW when the acquisition phase (t_8) is complete, the internal sample-and-hold is put into the hold state and a conversion is immediately started.
37	REF	AI	This input pin is used to provide a reference to the converter.
38	REFGND	AI	Reference Input Analog Ground.
39, 41	INB1, INB2	AI	Channel B Analog Inputs.
40, 45	INBN, INAN	AI	Analog Inputs Ground Senses. Allow to sense each channel ground independently.
42, 43	REFB, REFA	AI	These inputs are the references applied to Channel A and Channel B, respectively.
44, 46	INA2, INA1 EPAD	AI	Channel A Analog Inputs. Exposed Pad. The exposed pad is connected to ground; however, this connection is not required to meet specified performance.

¹ AI = input; DI = digital input; DO = digital output; DI/O = bidirectional digital; P = power.

OUTLINE DIMENSIONS

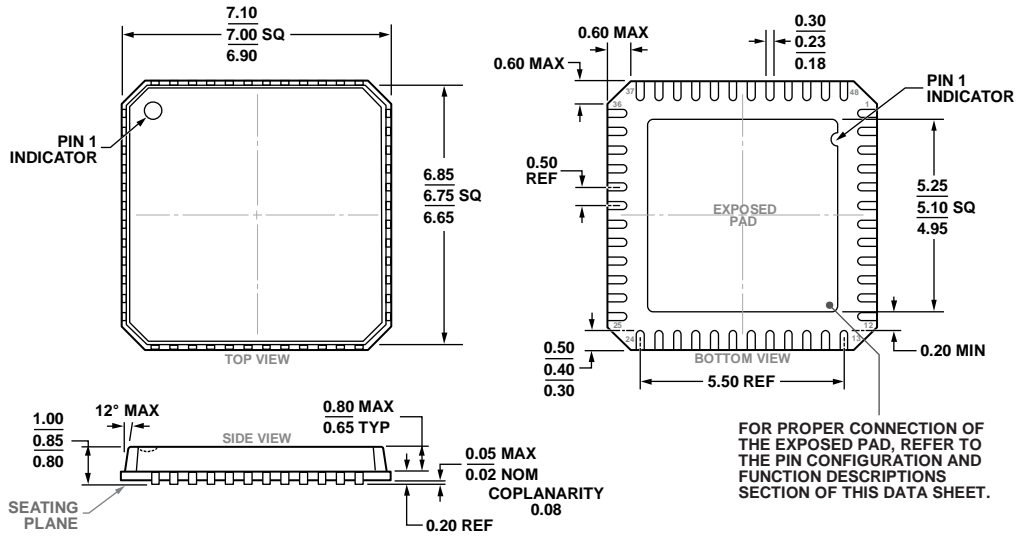

COMPLIANT TO JEDEC STANDARDS MO-220-VKGD-2

Figure 6. 48-Lead Lead Frame Chip Scale Package [LFCSP]
7 mm x 7 mm Body and 0.85 mm Package Height
(CP-48-1)

Dimensions shown in millimeters

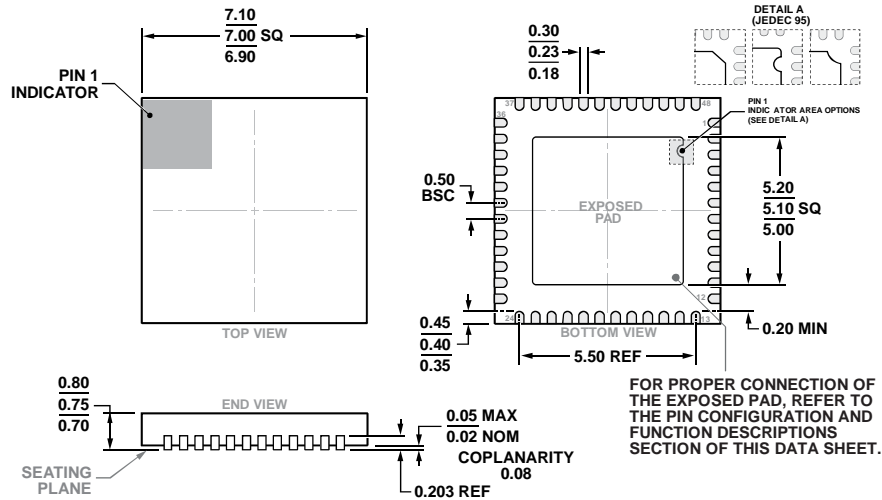

COMPLIANT TO JEDEC STANDARDS MO-220-WKGD-4

Figure 7. 48-Lead Lead Frame Chip Scale Package [LFCSP]
7 mm x 7 mm Body and 0.75 mm Package Height
(CP-48-4)

Dimensions shown in millimeters

ORDERING GUIDE

Model¹	Temperature Range	Package Description	Package Option
AD7655SCP-EP-RL	-55°C to +125°C	48-Lead Lead Frame Chip Scale Package [LFCSP]	CP-48-1
AD7655SCPZ-EP-RL	-55°C to +125°C	48-Lead Lead Frame Chip Scale Package [LFCSP]	CP-48-4

¹ Z = RoHS Compliant Part.