

Digital Output Micro Pressure Sensor

MMR920C04 Data Sheet

DESCRIPTION

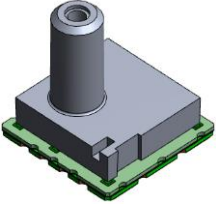

The MMR920C04 digitally outputs a micro pressure value which was corrected. Customers need no correction because it corrects and outputs the differences of sensors and temperature characteristics. It does not require complicated sensor drive or control circuit, and devices with high performance can be made only with this module and an external microcontroller which will be the host.

FEATURES

- Small package: 7.0(W) × 7.0(D) × 7.2(H)mm
- Operating pressure range -40~+40cmH₂O (-3.922~+3.922kPa)
Effective resolution: 0.002cmH₂O_{RMS} (98.1Pa_{RMS}) (at MODE4)
Pressure measurement error: ±0.5[%FS]
- It corrects the differences of sensors and temperature characteristics when shipped from our factory.
- It digitally outputs pressure value corrected in the module. (SPI/I²C)
I²C slave address (7 bits) is 0x67
- Noise reduction is possible by a built-in Low Pass Filter.

Index

DESCRIPTION	1
FEATURES	1
BLOCK DIAGRAM.....	3
PIN CONFIGURATION.....	4
TERMINAL EXPLANATIONS	5
ABSOLUTE MAXIMUM RATINGS	6
RECOMMENDED OPERATING CONDITIONS	6
ELECTRICAL CHARACTERISTICS	7
Analog characteristics	7
Digital I/O.....	8
Pressure sensor characteristics.....	9
Temperature sensor characteristics	9
Definition of characteristics	10
FUNCTION EXPLANATION.....	12
Function Outline.....	12
State transition table	13
Command code	14
Flow chart of pressure/temperature measurement.....	16
Timing Chart.....	17
Low Pass Filter	18
SEIAL INTERFACE	19
Baud rate.....	19
SPI AC Characteristics.....	20
SPI format	21
I2C AC Characteristics	23
I2C format	24
TYPICAL APPLICATION CIRCUIT	26
TYPICAL PERFORMANCE CHARACTERISTICS	27
DIMENSIONS	33
NOTES.....	34
Safety Precautions.....	34
Application considerations during actual circuit design	34
Precautions for Foreign Exchange and Foreign Trade Control Act	35
Prohibitions for Industrial Property Rights	35
Precautions for Product Liability Act.....	35
Others	35
ATTENTION	35
ADDDITIONAL NOTES.....	35
MARKING CONTENTS	36
RECOMMENDED LAND PATTERN.....	37
CONDITION FOR PACKAGE MOUNTING.....	38
Pb-Free recommended profile condition	38
Storage method	39
LINEUP	42

BLOCK DIAGRAM

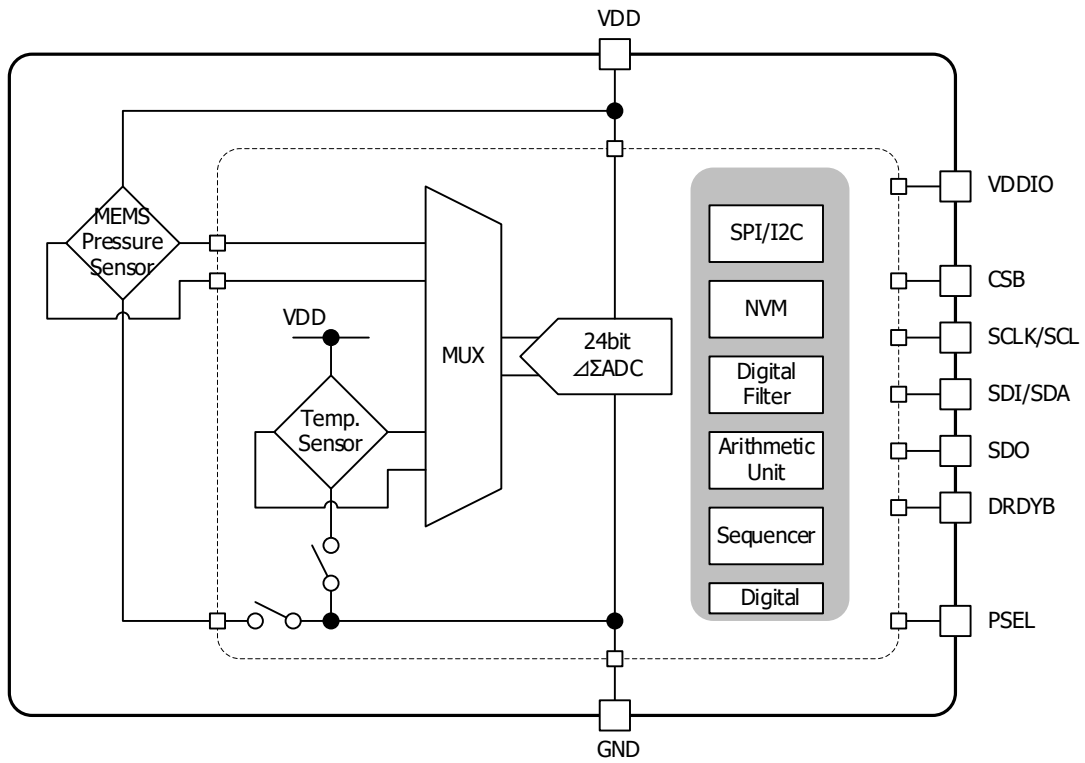

Fig. 1 Block diagram

PIN CONFIGURATION

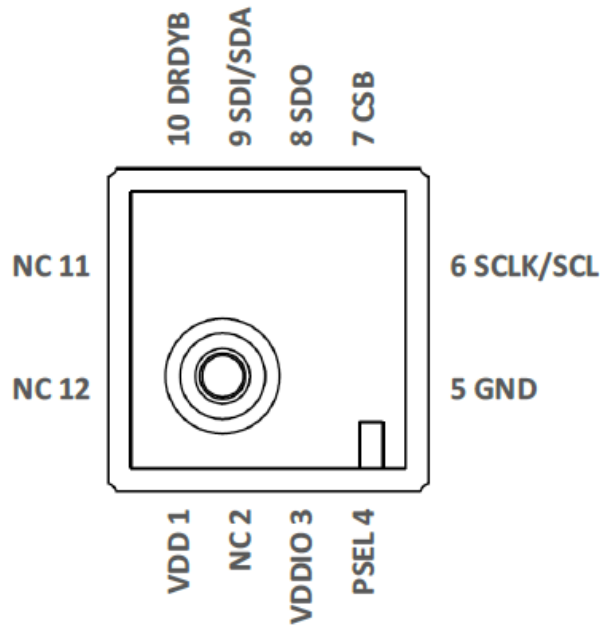

Fig. 2 Pin configuration (Top view)

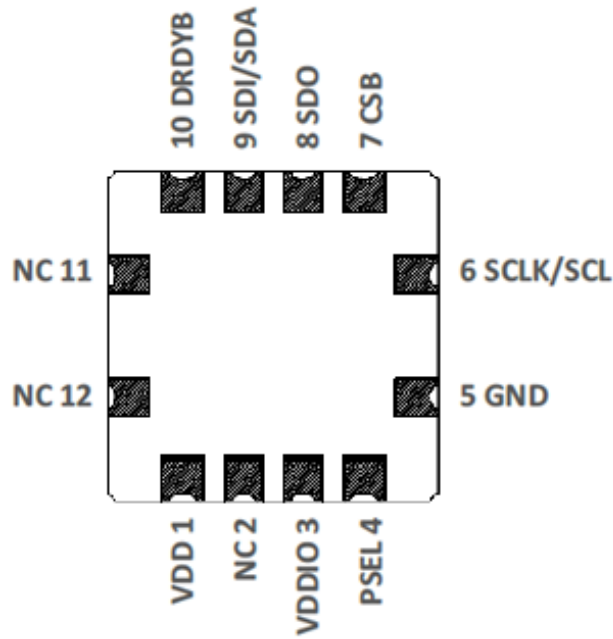

Fig. 3 Pin configuration (Bottom view)

TERMINAL EXPLANATIONS

Table 1 Pin table

No.	Pin Name	Type	Function
1	VDD	I	Power-supply for analog circuit
2	NC	-	No connect.
3	VDDIO	I	Power-supply for digital I/O
4	PSEL	I	Protocol select terminal(High : SPI/Low:I2C) * PSEL is not pull-up / pull-down in the internal circuit. Please use it must be connected to VDDIO or GND.
5	GND	-	GND
6	SCLK SCL	I I/O	Serial clock for SPI communication (SCLK) Serial clock for I2C communication (SCL)
7	CSB	I	Chip select for SPI communication *Please set to open circuit when I2C is used
8	SDO	O	Serial Data Output for SPI communication (SDO=MISO) *Please set to open circuit when I2C is used
9	SDI SDA	I I/O	Serial Data Input for SPI communication (SDI=MOSI) Serial Data (Input and output) for I2C communication (SDA)
10	DRDYB	O	Output terminal which notifies the completion of pressure measurement and calculation correction (negative logic)
11	NC	-	No connect.
12	NC	-	No connect.

ABSOLUTE MAXIMUM RATINGS

(unless otherwise specified, Ta=25°C)

Item	Symbol	Min.	Max.	Unit
Storage temperature range	T _{STG}	-40	85	°C
Analog supply voltage	VDD _{MAX}	-0.3	4.0	V
Digital I/O voltage	VDDIO _{MAX}	-0.3	4.0	V
Overpressure (note ¹)	P _{MAX}	-80 (-7.845)	+80 (+7.845)	cmH ₂ O (kPa)
Burst pressure (note ²)	P _{Burst}	-500 (-49)	+500 (+49)	cmH ₂ O (kPa)
Pressure medium (note ³)	-	AIR (non-condensing)		-

note¹: Overpressure is the maximum pressure to which the device can be taken and still meet specifications when return to the Operating pressure range.

note²: Burst pressure is the pressure at which the IC is damaged and leaks occur.

note³: Storage and operation in an environment of dry and non-corrosive gases.

RECOMMENDED OPERATING CONDITIONS

(unless otherwise specified, Ta=25°C)

Item	Symbol	Min.	Typ.	Max.	Unit
Operating temperature range	T _{OPR}	0	-	50	°C
Analog supply voltage	VDD _{OPR}	3.0	3.3	3.6	V
Digital input voltage	VDDIO _{OPR}	1.2	-	3.6	V
Operating pressure range	P _{OPR}	-40 (-3.922)	-	+40 (+3.922)	cmH ₂ O (kPa)
Full Scale	FS	-	40 (3.922)	-	cmH ₂ O (kPa)

ELECTRICAL CHARACTERISTICS

Analog characteristics
(unless Ta=25°C, VDD=VDDIO=3.3V)

Item	Symbol	Condition	Min.	Typ.	Max.	Unit.
VDD Current consumption	I _{VDDact}	Pressure measure active	640	800	960	μA
	I _{VDDsd}	Shutdown	-	0.01	0.1	
VDDIO Current consumption	I _{VDDIOact}	Pressure measure active	1.4	2.5	3.0	μA
	I _{VDDIOsd}	Shutdown	-	0.1	1.0	
Conversion time (note ⁴)	t _{con1}	MODE1	0.385	0.395	0.405	msec
	t _{con2}	MODE2	0.770	0.790	0.810	
	t _{con3}	MODE3	1.54	1.58	1.62	
	t _{con4}	MODE4	3.08	3.16	3.24	

note⁴: The conversion time is longer when the temperature is measured once every 256 times and the characteristic correction is updated.

Digital I/O

(unless otherwise specified, Ta=25°C, VDD=3.0~3.6V, VDDIO=1.2~3.6V)

Item	Symbol	Conditions	Min.	Typ.	Max.	Unit
High level input voltage	V _{IH}	-	0.8 × VDDIO	-	VDDIO +0.3	V
Low level input voltage	V _{IL}	-	-0.3	-	0.2 × VDDIO	V
Output voltage High level	V _{OH1}	VDDIO ≥ 2.0V I _{OH} =-3mA	VDDIO -0.4	-	-	V
	V _{OH2}	VDDIO < 2.0V I _{OH} =-1mA	0.8 × VDDIO	-	-	V
Output voltage Low level	V _{OL1}	VDDIO ≥ 2.0V I _{OL} =3mA	-	-	0.4	V
	V _{OL2}	VDDIO < 2.0V I _{OL} =1mA	-	-	0.2 × VDDIO	V

Pressure sensor characteristics

(unless otherwise specified, Ta=25°C, VDD=3.3V, VDDIO=1.2~3.6V)

Item	Symbol	Condition	Min.	Typ.	Max.	Unit
Pressure resolution	P _{Res}	-	-	0.00001	-	cmH2O
Pressure effective resolution	P _{Eres1}	MODE1 (tcon1 = Typ 0.395ms)	-	0.019	0.076	cmH2O RMS
	P _{Eres2}	MODE2 (tcon2 = Typ 0.790ms)	-	0.009	0.036	
	P _{Eres3}	MODE3 (tcon3 = Typ 1.58ms)	-	0.004	0.016	
	P _{Eres4}	MODE4 (tcon4 = Typ 3.16ms)	-	0.002	0.008	
Pressure measurement error	t _{HRESP}	-40 ~ +40cmH2O Ta = 0°C~50°C	-1.0	-	1.0	%FS (note ⁵)
Pressure span accuracy	P _{Sacc}	-40 ~ +40cmH2O Ta = 0°C~50°C	-0.65	-	0.65	%FS (note ⁵)
Pressure span accuracy Long term drift	P _{Slt}	-40 ~ +40cmH2O Ta = 0°C~50°C	-	-	±0.35	%FS (note ⁵)
Pressure linearity	P _L	-40 ~ +40cmH2O Ta = 0°C~50°C	-0.22	-	0.22	%FS (note ⁵)

note⁵: Ratio to Full Scale (40cmH2O).

Temperature sensor characteristics

(unless otherwise specified, Ta=25°C, VDD=3.3V VDDIO=1.2~3.6V)

Item	Symbol	Conditions	Min.	Typ.	Max.	Unit
Temperature measurement error	T _{acc}	0°C~ 50°C	-2.0	-	2.0	°C

Definition of characteristics

Pressure measurement value P_{result}

It is the device output value obtained by Read Pressure Result Command.

Pressure resolution P_{Res}

This Value is equivalent to 1LSB of output digital value.

Pressure effective resolution P_{Eres}

Measure 16 points after the pressure output is stable, and it is the standard deviation of the 16 points.

Pressure measurement error P_{Err}

It is the deviation amount of the Pressure measurement value from the ideal line. (Refer to Fig. 4)

Fig. 5 shows source of error included in the pressure measurement error.

Pressure linearity P_L

It is the amount of deviation from the Ref. line connecting measurement value $-40\text{cmH}_2\text{O}$ with $+40\text{cmH}_2\text{O}$. (Refer to Fig. 4)

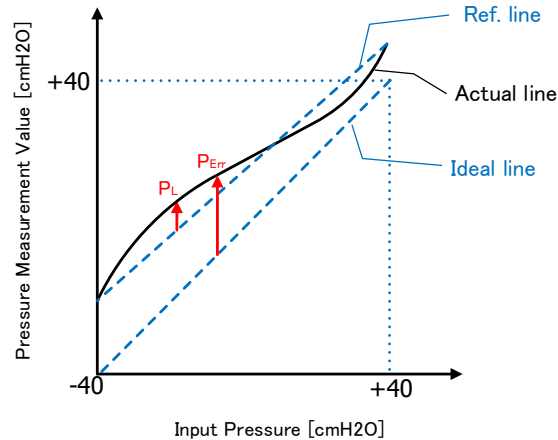

Fig. 4 Definition of Characteristics

Pressure span accuracy P_{Sacc}

It is the accuracy removing the error caused by the offset from the pressure measurement error. (Refer to Fig. 5)

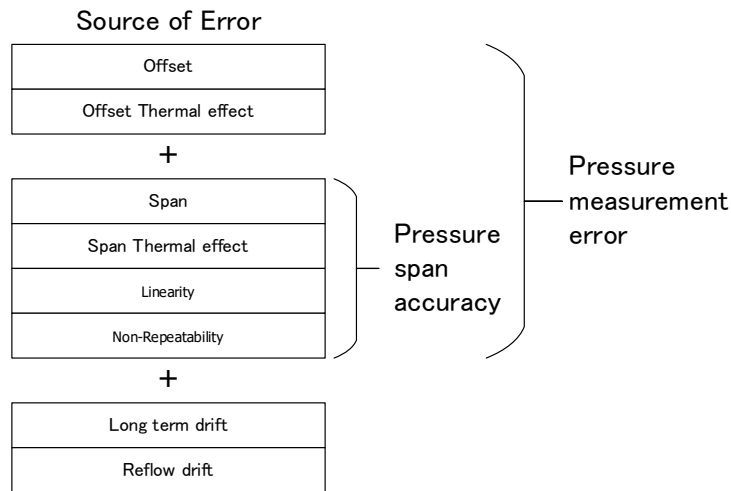

Fig. 5 Source of Error

Pressure span accuracy Long term drift P_{SltD}

The amount of fluctuation in Pressure span accuracy over a long term.

FUNCTION EXPLANATION

Function Outline

The MMR920C04 is consists of piezo resistive pressure sensor and an analog front end IC.

It converts analog output voltage from piezo resistive pressure sensor to digital value of 24 bits, and corrects and outputs variations of sensor characteristics due to variations of temperature and process.

Conversion time and Pressure effective resolution are selectable with the mode of different four. Conversion time and Pressure effective resolution are in the relationship of trade-off.

Noise reduction is possible by a built-in Low Pass Filter. Cutoff frequency of Low Pass Filter can be changed.

State transition table

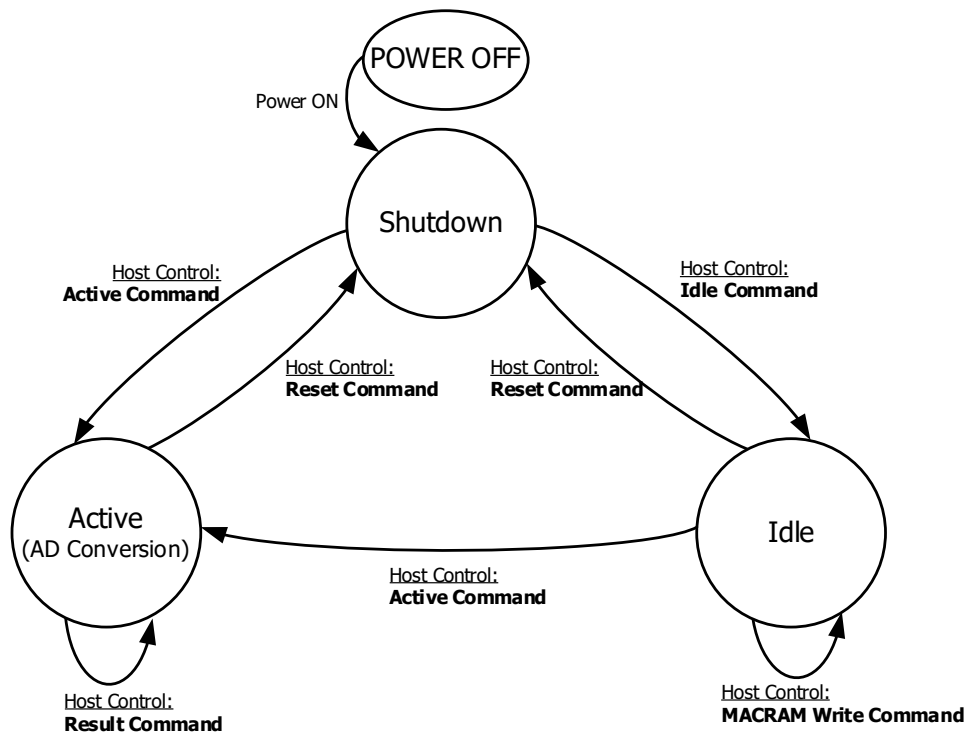

Fig. 6 State transition diagram

Table 2 State transition table

State Command	Shutdown	Active	Idle
Reset	Power on Reset & Initial Boot =>Shutdown	Power on Reset & Initial Boot =>Shutdown	Power on Reset & Initial Boot =>Shutdown
Active	Reset & Boot Load =>Active state(AD conversion)	Ignore(note ⁶) =>Keep state	=>Active state (AD conversion)
Result	Ignore(note ⁶) =>Keep state	Output result =>Keep state	Do not issue(note ⁷) =>Keep state
Idle	Reset & Boot Load =>Idle state	Do not issue(note ⁸) =>Idle state	=>Keep state
MACRAM Write	Ignore(note ⁶) =>Keep state	Do not issue(note ⁸) =>Keep state	Change cutoff frequency =>Keep state
Status	Output code =>Keep state	Output code =>Keep state	Output code =>Keep state

note⁶: NACK is returned to the command.

note⁷: The correct result isn't output. Additionally, ACK is returned to the command.

note⁸: Although command is acceptable, it goes unintended behavior since sequence is running.

Command code

Table 3 Command code list

Command Name		Command Code									Applicable format	
		HEX.	BIN.									
			C7	C6	C5	C4	C3	C2	C1	C0		
Reset		0x72	0	1	1	1	0	0	1	0	SPI Write format I2C Write format	
		Reset and Return to Shutdown state. It becomes busy for the maximum 1.8msec.										
Idle		0x94	1	0	0	1	0	1	0	0	SPI Write format I2C Write format	
		Start up the internal circuit and put it in the idle state.										
Active	Measure at MODE 1	0xA0	1	0	1	0	0	0	0	0	SPI Write format I2C Write format	
	Measure at MODE 2	0xA2	1	0	1	0	0	0	1	0		
	Measure at MODE 3	0xA4	1	0	1	0	0	1	0	0		
	Measure at MODE 4	0xA6	1	0	1	0	0	1	1	0		
Start AD conversion.												
Normal		0xC0	1	1	0	0	0	0	0	0	SPI Write/Read format I2C Combined format	
		With Low Pass Filter	0xC4	1	1	0	0	0	1	0		0
Read Pressure Result		Read compensated pressure result. It outputs the result of pressure measurement at 24bits, MSB first. A negative number is expressed by 2's complement. About output range, in case of positive output : 000000 h ~ 7FFFFFF h (in decimal number : 0 ~ +8388607), in case of negative output : FFFFFFF h ~ 800000 h (in decimal number : -1 ~ -8388608) However, the result of measurement when being used beyond a recommended operating condition can't be guaranteed. Pressure value = DEC. / 10 ⁵ Output example:										
		HEX.	DEC.	Pressure								
		800000 h	-8388608	-83.88608cmH2O								
		C2F700 h	-4000000	-40.00000cmH2O								
		FFFFFF h	-1	-0.00001cmH2O								
		000000 h	0	0.00000cmH2O								
		000001 h	1	0.00001cmH2O								
		3D0900 h	4000000	40.00000cmH2O								
		7FFFFFF h	8388607	83.88607cmH2O								

Table 4 Command code list (continued)

Command Name	Command Code									Applicable format																																			
	HEX.	BIN.																																											
		C7	C6	C5	C4	C3	C2	C1	C0																																				
Read Temperature Result	0xC2	1	1	0	0	0	0	1	0	SPI Write/Read format I2C Combined format																																			
	<p>Read compensated temperature result. It outputs the result of pressure measurement at 24bits, MSB first. A negative number is expressed by 2's complement. About output range, in case of positive output : 000000 h ~ 7FFFFFFF h (in decimal number : 0 ~ +8388607), in case of negative output : FFFFFFFF h ~ 800000 h (in decimal number : -1 ~ -8388608) However, the result of measurement when being used beyond a recommended operating condition can't be guaranteed.</p> <p>Temperature value = DEC. / 2⁷</p> <p>Output example:</p> <table border="1"> <thead> <tr> <th>HEX.</th> <th>DEC.</th> <th>Temperature</th> </tr> </thead> <tbody> <tr> <td>000000 h</td> <td>0</td> <td>0.000 °C</td> </tr> <tr> <td>000C80 h</td> <td>3200</td> <td>25.000 °C</td> </tr> <tr> <td>001900 h</td> <td>6400</td> <td>50.000 °C</td> </tr> </tbody> </table>										HEX.	DEC.	Temperature	000000 h	0	0.000 °C	000C80 h	3200	25.000 °C	001900 h	6400	50.000 °C																							
HEX.	DEC.	Temperature																																											
000000 h	0	0.000 °C																																											
000C80 h	3200	25.000 °C																																											
001900 h	6400	50.000 °C																																											
Status	0x80	1	0	0	0	0	0	0	0	SPI Write/Read format I2C Combined format																																			
	<p>Output 8bits data depending on the IC conditions</p> <table border="1"> <thead> <tr> <th>D7</th> <th>D6</th> <th>D5</th> <th>D4</th> <th>D3</th> <th>D2</th> <th>D1</th> <th>D0</th> <th>State</th> </tr> </thead> <tbody> <tr> <td>0</td> <td>0</td> <td>0</td> <td>0</td> <td>0</td> <td>0</td> <td>0</td> <td>0</td> <td>Shutdown</td> </tr> <tr> <td>1</td> <td>1</td> <td>1</td> <td>0</td> <td>0</td> <td>1</td> <td>0</td> <td>1</td> <td>Idle</td> </tr> <tr> <td>1</td> <td>1</td> <td>1</td> <td>0</td> <td>1</td> <td>1</td> <td>0</td> <td>1</td> <td>Active</td> </tr> </tbody> </table>										D7	D6	D5	D4	D3	D2	D1	D0	State	0	0	0	0	0	0	0	0	Shutdown	1	1	1	0	0	1	0	1	Idle	1	1	1	0	1	1	0	1
D7	D6	D5	D4	D3	D2	D1	D0	State																																					
0	0	0	0	0	0	0	0	Shutdown																																					
1	1	1	0	0	1	0	1	Idle																																					
1	1	1	0	1	1	0	1	Active																																					
MACRAM Write	0xE4	1	1	1	0	0	1	0	0	SPI MACRAM Write format I2C MACRAM Write format (special format)																																			
	It is used for writing filter coefficient. For the filter coefficient, refer to 10-6. LowPassFilter .																																												

Timing Chart

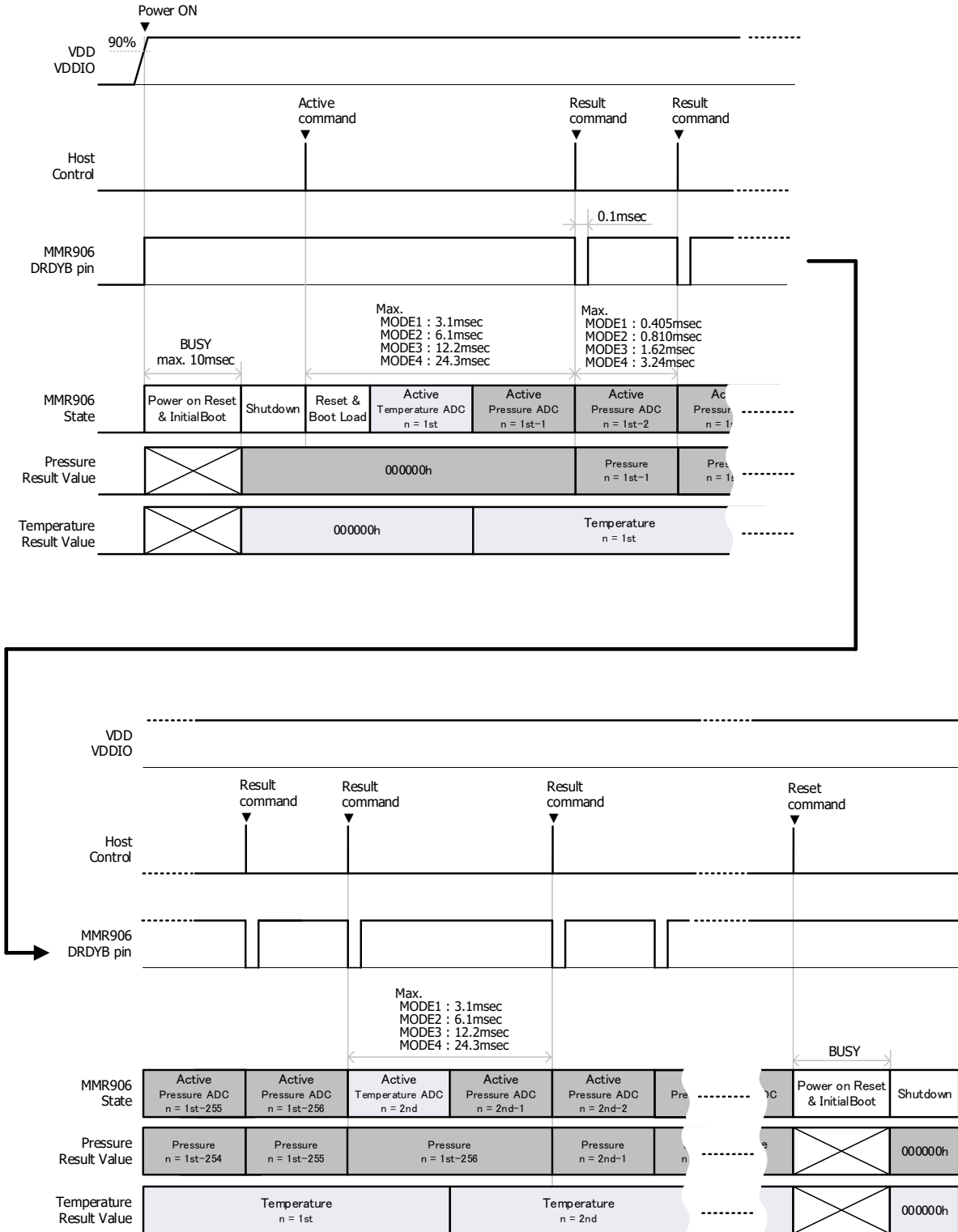

Fig. 8 Timing Chart

Low Pass Filter

Noise reduction is possible by a built-in Low Pass Filter. Pressure value with Low Pass Filter applied can be got using command code 0xC4. Cutoff frequency f_c can be changed by filter coefficient 4Bytes calculated by the equation (1). Filter coefficient is written to the IC using the MACRAM Write command in the idle state. Filter coefficient is cleared to the default value in the shutdown state.

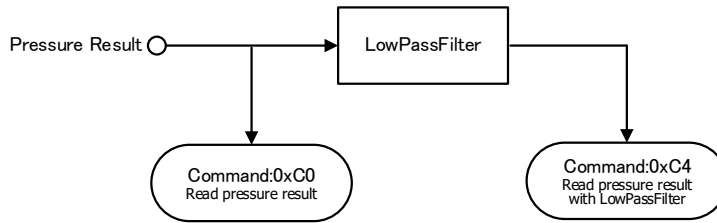

Fig. 9 Low Pass Filter Configuration

Table 5 example of character with Low Pass Filter

Cutoff frequency		No filter	fc=100Hz	fc=10Hz
Pressure effective resolution example [cmH2O RMS]	MODE1	0.019	0.012	0.0068
	MODE2	0.008	0.0064	0.0034
	MODE3	0.0044	0.0036	0.0022
	MODE4	0.0025	0.0023	0.0013

Filter coefficient equation

$$\text{Filter coefficient(4Bytes)} = 2^{27} \times \exp(-2\pi \times f_c \times t_{con}) \dots \dots \dots (\text{Eq1})$$

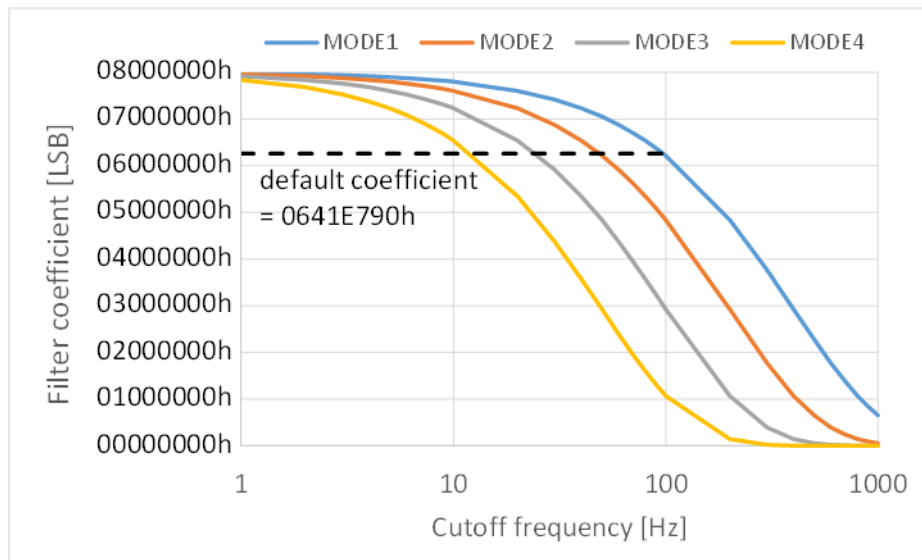

Fig. 10 Filter coefficient example

SERIAL INTERFACE

It supports SPI and I2C as an interface for serial communication. SPI (max. 5Mbps) or I2C (max.3.4Mbps) can be selected by PSEL terminal. When PSEL terminal is set to High, SPI will be selected. When it is set to Low, I2C will be selected. Please set High voltage of PSEL terminal the same potential as VDDIO terminal.

Baud rate

※ This item is not inspected at the time of shipment.
(unless otherwise specified, Ta=25°C, VDD=3.0~3.6V)

Item	Symbol	Conditions	Min.	Typ.	Max.	Unit
I2C communication speed	BR _{I2C1}	VDDIO ≥ 2.0V Cb ≤ 100pF	-	-	3.4	Mbps
	BR _{I2C2}	VDDIO < 2.0V Cb ≤ 100pF	-	-	0.4	
	BR _{I2C3}	VDDIO ≥ 2.0V Cb ≤ 400pF	-	-	1.7	
	BR _{I2C4}	VDDIO < 2.0V Cb ≤ 400pF	-	-	0.4	
SPI communication speed	BR _{SPI1}	VDDIO ≥ 2.0V Cb ≤ 100pF	-	-	5.0	
	BR _{SPI2}	VDDIO < 2.0V Cb ≤ 100pF	-	-	1.0	
	BR _{SPI3}	VDDIO ≥ 2.0V Cb ≤ 400pF	-	-	2.5	
	BR _{SPI4}	VDDIO < 2.0V Cb ≤ 400pF	-	-	0.5	

SPI AC Characteristics

※ This item is not inspected at the time of shipment.

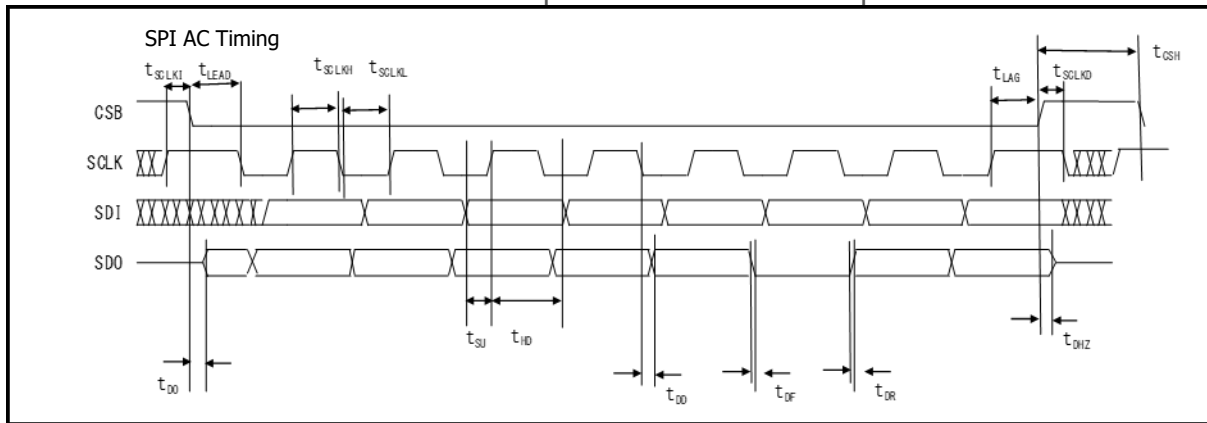

Fig. 11 SPI SPI AC timing chart

Table 6 SPI AC Characteristics

Items	Symbol	VDDIO<2V		VDDIO≥2V		Unit
		min.	max.	min.	max.	
SCLK frequency (Duty 50±10%)	f_{SCLK}	-	1	-	5	MHz
SCLK High period (90%~90%)	t_{SCLKH}	400		80	-	ns
SCLK Low period (10%~10%)	t_{SCLKL}	400		80	-	ns
SCLK wait time	t_{SCLKI}	500	-	100	-	ns
SCLK Delay time	t_{SCLKD}	0	-	0	-	ns
CSB High period (90%~90%)	t_{CSH}	1000	-	200	-	ns
Time from CSB falling to SCLK falling	t_{LEAD}	0	-	0	-	ns
Time from SCLK rising to CSB rising	t_{LAG}	500	-	100	-	ns
SDI setup time	t_{SU}	100	-	10	-	ns
SDI hold time	t_{HD}	10	-	10	-	ns
SDO rise time (Load 100pF) (10%~90%)	t_{DR}		50	-	50	ns
SDO fall time (Load 100pF) (10%~90%)	t_{DF}		50	-	50	ns
SDO output delay time (Load 100pF)	t_{DDY}	-	120	-	60	ns
Time from CSB falling to SDO output (Load 100pF)	t_{ACC}	-	120	-	60	ns
Time from CSB rising to SDO output HiZ (Load 100pF)	t_{DHZ}	-	170	-	170	ns

SPI format

The basic format of SPI is shown below. The relationship between clock (SCLK) and data (SDI/SDO) is Mode3. Data send/receive is started when CSB becomes low level from the status when SCLK is high level. Data is updated on falling edges of the SCLK, and sampled on rising edges of the SCLK. Data send/receive is ended when CSB becomes high level from the status when SCLK is high level.

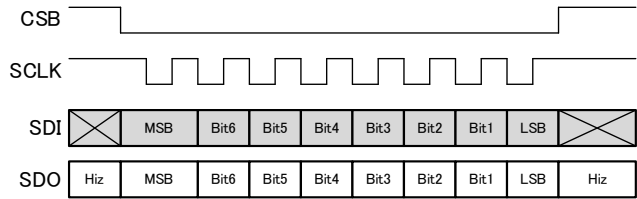

Fig. 12 SPI Waveform

SPI Write form

Please send command code of 8 bits. When their commands are received, it turns over ACK to 8 bits.



Fig. 13 SPI Write forma

SPI Write/Read format

Please send command code of 8 bits. When the command is received, it turns over ACK to 8 bits and it outputs the data MSB first.

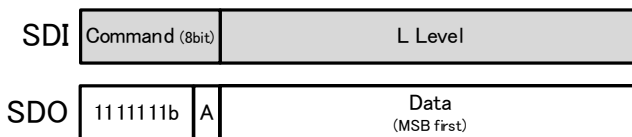

Fig. 14 SPI Write/Read format

SPI MACRAM Write format

Please send command code (0xE4) and memory address (0x6F). When command is received, it turns over ACK to 8 bits. Then please send Filter coefficient of 4Bytes MSB first. After receiving data, it becomes busy for the maximum 15msec in order to data- writing. During this time, 00h which indicates busy is output. When data- writing is completed, 01h is output.

How to discern busy:

After sending write data, continue to input clock with maintaining communicating mode. Then, 00h is output to indicate that it is busy. When the writing has been completed, 01h will be output. *The "00h" to indicate busy may sometimes be output or not depending on the clock frequency.

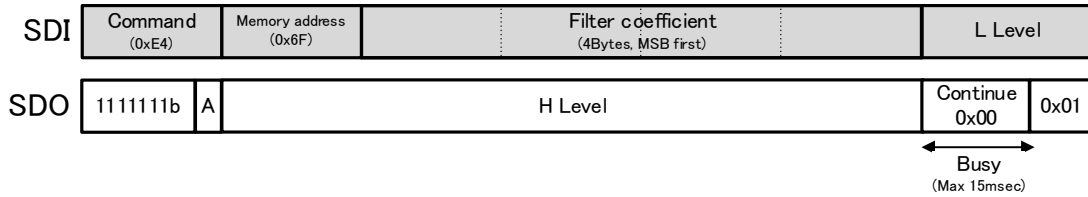

Fig. 15 SPI MACRAM Write forma

SPI ACK

When command code which is send in each SPI format is received, it outputs L level to 8 bits as ACK. If command code is not accepted or command code is not valid, it outputs H Level to 8 bits as NACK.

I2C AC Characteristics

※ This item is not inspected at the time of shipment

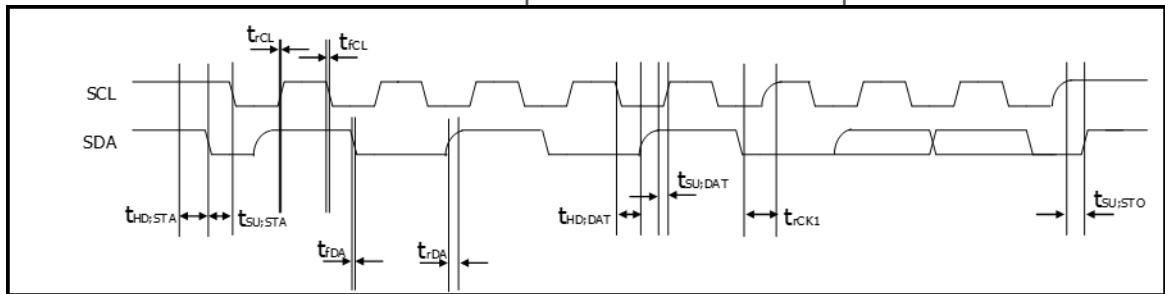

Fig. 16 I2C AC timing chart

Table 7 I2C AC Characteristics

Items	Symbol	VDDIO < 2.0V		VDDIO ≥ 2.0V				Unit
		Fast mode		Hsmode				
				Cb=100pF		Cb=400pF		
		min.	max.	min.	max.	min.	max.	
SCL frequency	f_{SCL}	0	400kHz	0	3.4	0	1.7	MHz
Start condition setup time	$t_{SU;STA}$	600	-	160	-	160	-	ns
Start condition hold time	$t_{HD;STA}$	600	-	160	-	160	-	ns
Stop condition setup time	$t_{SU;STO}$	600	-	160	-	160	-	ns
Data setup time	$t_{SU;DAT}$	100	-	20	-	20	-	ns
Data hold time (note ¹⁰)	$t_{HD;DAT}$	20	-	20	70	20	150	ns
SCL rise time	t_{rCL}	-	300	10	40	20	80	ns
Rise time of SCL after ACK (When clock stretch is released.)	t_{rCL1}	-	300	10	80	20	160	ns
SCL fall time	t_{fCL}	10	300	10	-	20	80	ns
SDA rise time	t_{rDA}	-	300	10	80	20	160	ns
SDA fall time	t_{fDA}	10	300	10	80	20	160	ns

note¹⁰: This product does not have the function to retain data in SDA.
Please ensure the hold of SDA with 20nsec for the area where SCL falling edge is not defined.

I2C format

It conforms to I2C protocol except some special formats. I2C address is the total of 8 bits. The first 7 bits are slave address and the rest of 1 bit is R/W bit. Slave address for MMR920C04 (7 bits) is 0x67. I2C address (8 bits) will be 0xCE (Write) and 0xCF (Read) by combining with R/W bit.

Table 8 I2C address

HEX.	I2C Address (8 bit)							R/W bit
	Slave address (7 bit)							
	A6	A5	A4	A3	A2	A1	A0	
0xCE	1	1	0	0	1	1	1	0
0xCF	1	1	0	0	1	1	1	1

I2C Write format

Please send I2C address of 8 bits (0xCE) by Write Mode. Then please send command code.

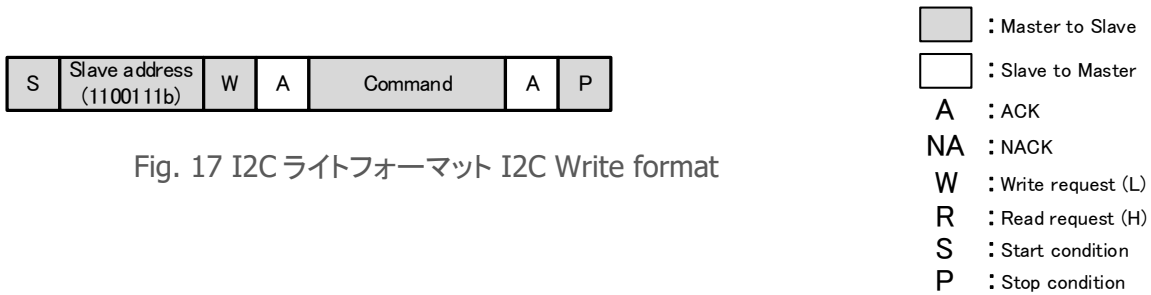

Fig. 17 I2C ライトフォーマット I2C Write format

Combined format

Please send I2C address (0xCE) and the command code by Write Mode. Then please send I2C address (0xCF) by Read Mode. It outputs the data MSB first

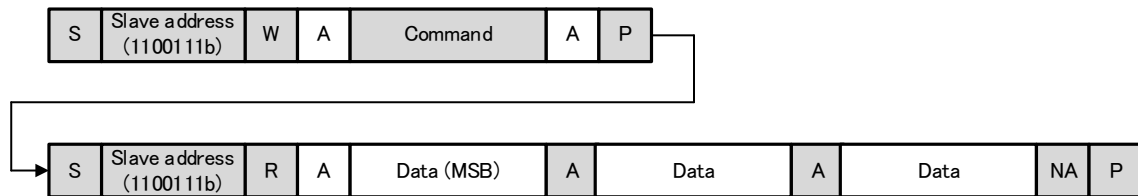

Fig. 18 I2C Combined format

I2C MAC Write format (special format)

It is a format unique to this product that does not partially conform to I2C protocol. Please send I2C address (0xCE), the command (0xE4), and memory address (0x6F) by Write Mode. Then send the data of 4Bytes Filter coefficient. At this time, please be careful that NACK is returned after transmitting LSB. After receiving data, it becomes busy for the maximum 15msec in order to data- writing. During this time, SCL is put in clock stretch. When data- writing is completed, SCL is released.

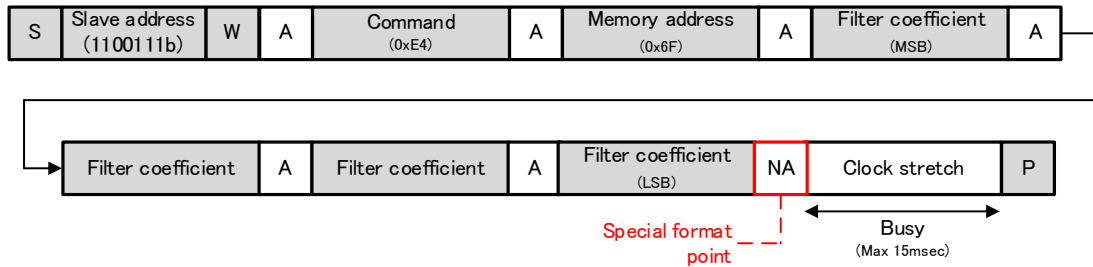

Fig. 19 I2C MACRAM Write format

TYPICAL APPLICATION CIRCUIT

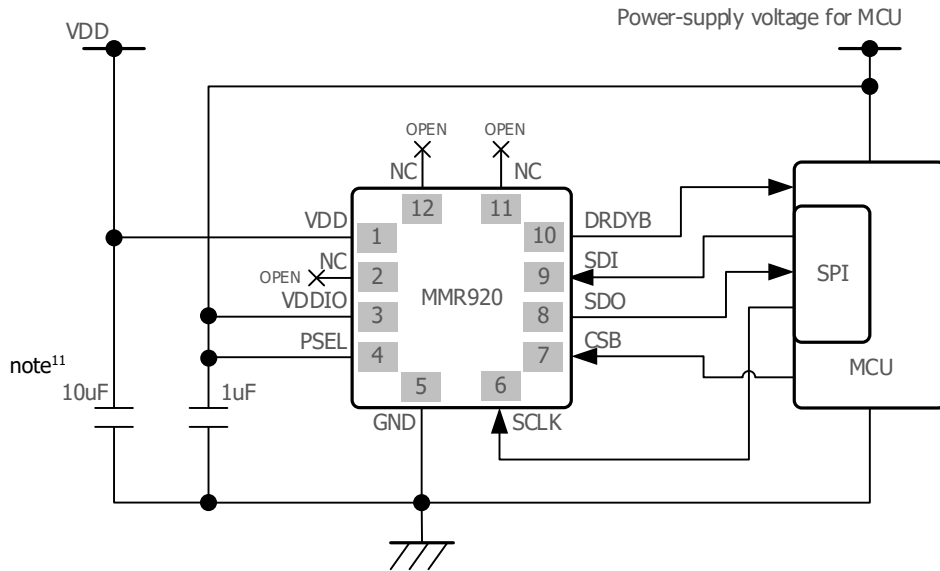

Fig. 20 Typical Electrical Connection (SPI)

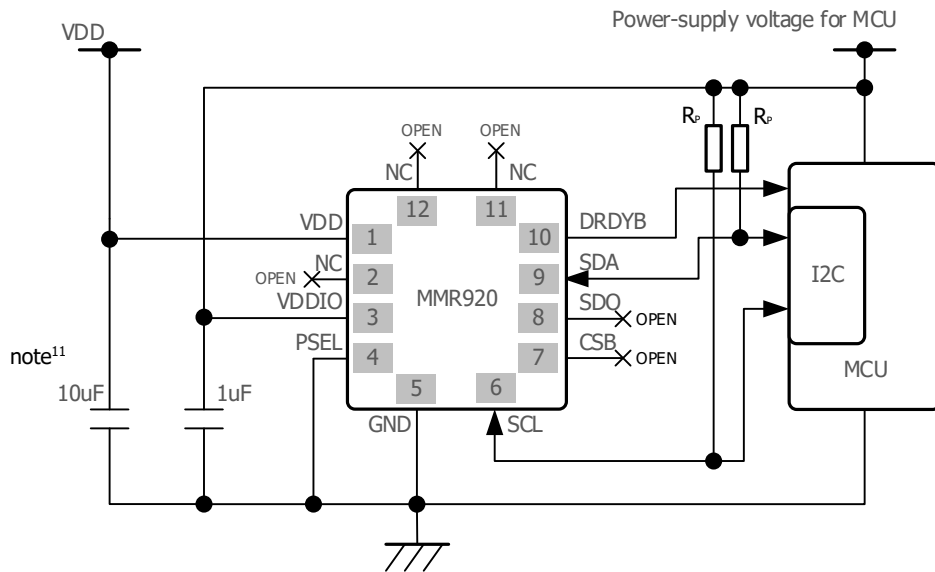

Fig. 21 Typical Electrical Connection (I2C)

note¹¹: Place the bypass capacitor for the power supply as close to the IC as possible.

TYPICAL PERFORMANCE CHARACTERISTICS

(unless otherwise specified, $T_a=25^\circ\text{C}$, $V_{DD}=V_{DDIO}=3.3\text{V}$)

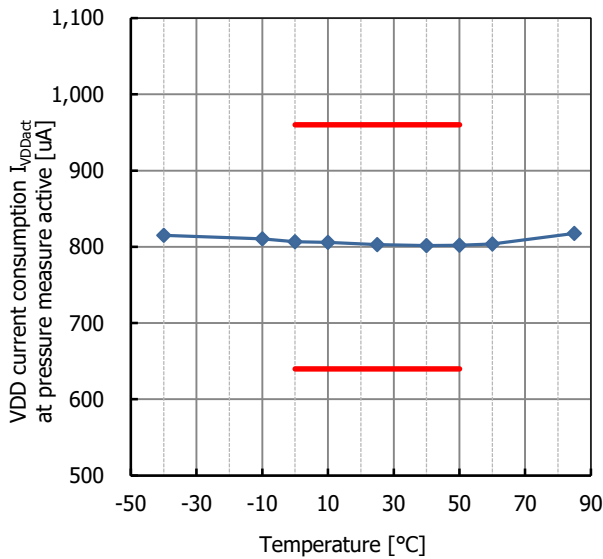

Fig. 22.1 VDD current consumption I_{VDDact} at pressure measure active temperature characteristic

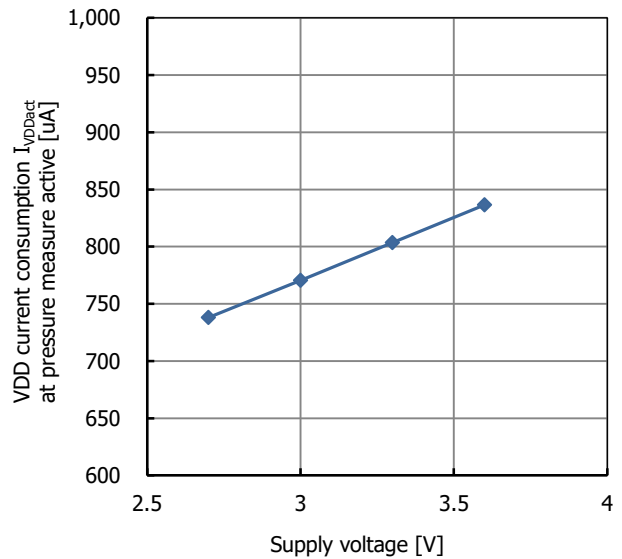

Fig. 22.2 VDD current consumption I_{VDDact} at pressure measure active supply voltage characteristic

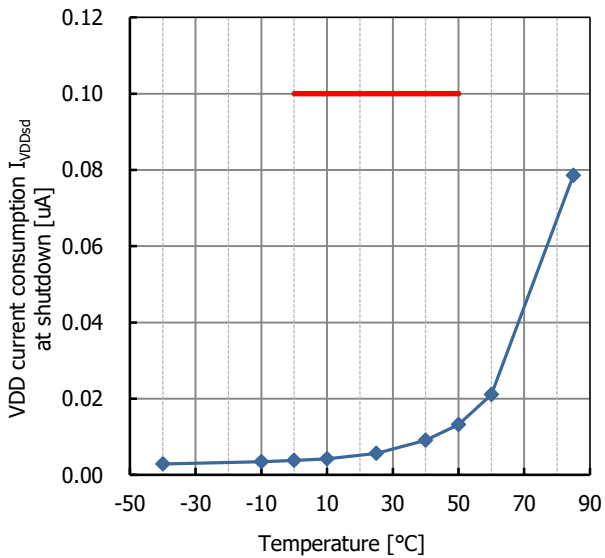

Fig. 22.4 VDD current consumption I_{VDDsd} at shutdown temperature characteristic

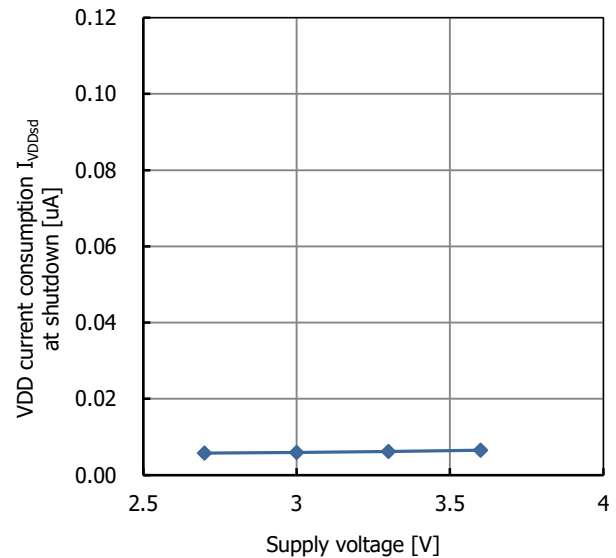

Fig. 22.3 VDD current consumption I_{VDDsd} at shutdown supply voltage characteristic

(unless otherwise specified, $T_a=25^\circ\text{C}$, $V_{DD}=V_{DDIO}=3.3\text{V}$)

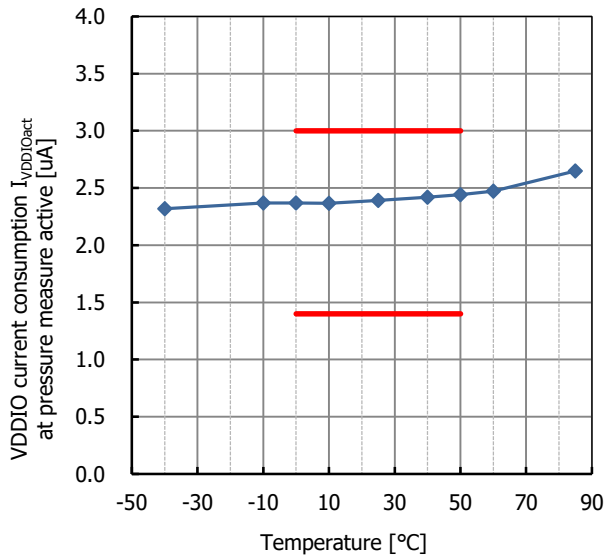

Fig. 22.5 VDDIO current consumption $I_{VDDIOact}$ at pressure measure active temperature characteristic

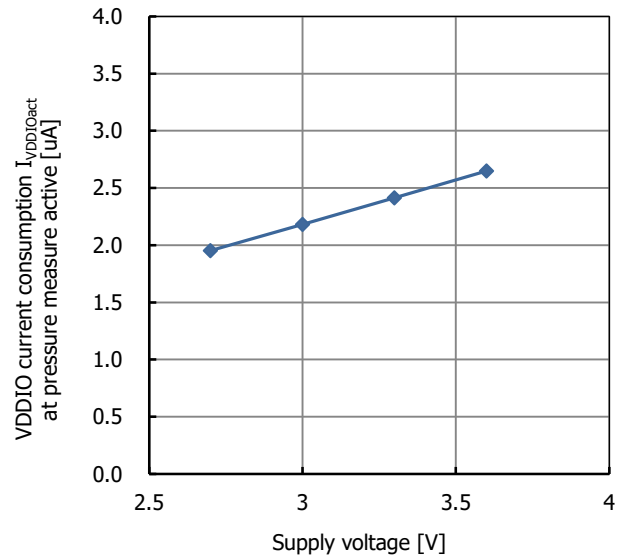

Fig. 22.6 VDDIO current consumption $I_{VDDIOact}$ at pressure measure active supply voltage characteristic

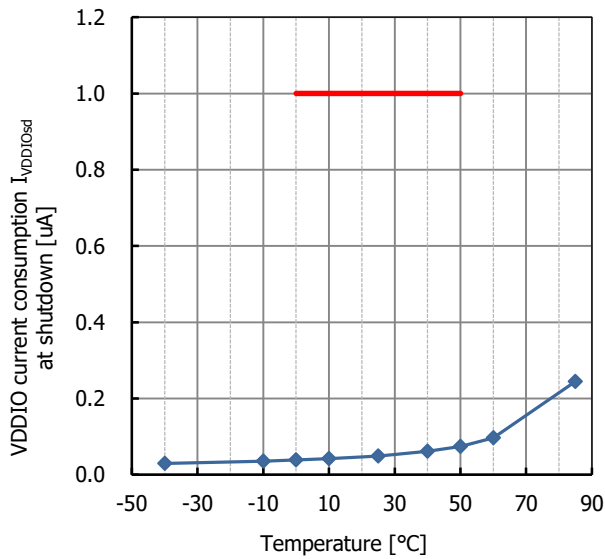

Fig. 22.8 VDDIO current consumption $I_{VDDIOsd}$ at shutdown temperature characteristic

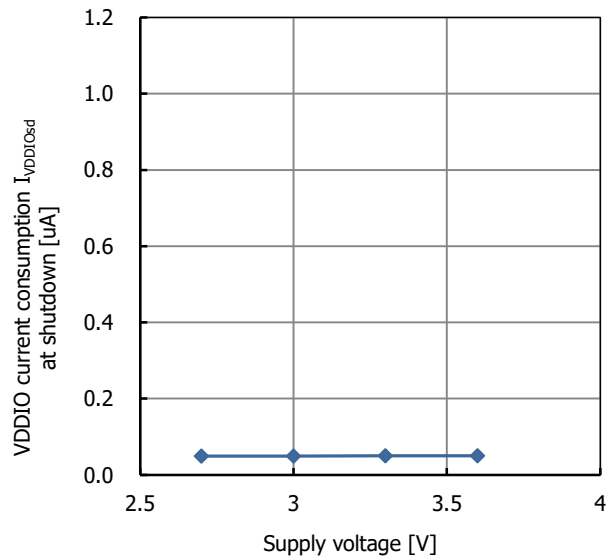

Fig. 22.7 VDDIO current consumption $I_{VDDIOsd}$ at shutdown supply voltage characteristic

(unless otherwise specified, $T_a=25^\circ\text{C}$, $V_{DD}=V_{DDIO}=3.3\text{V}$)

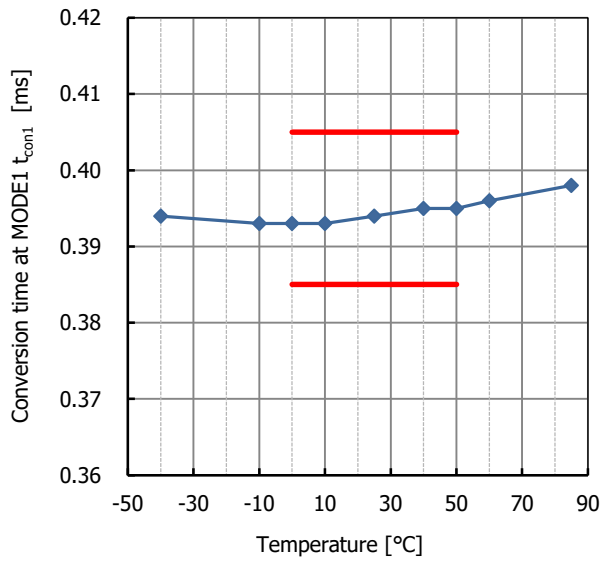

Fig. 22.9 Conversion time at MODE 1 temperature characteristic

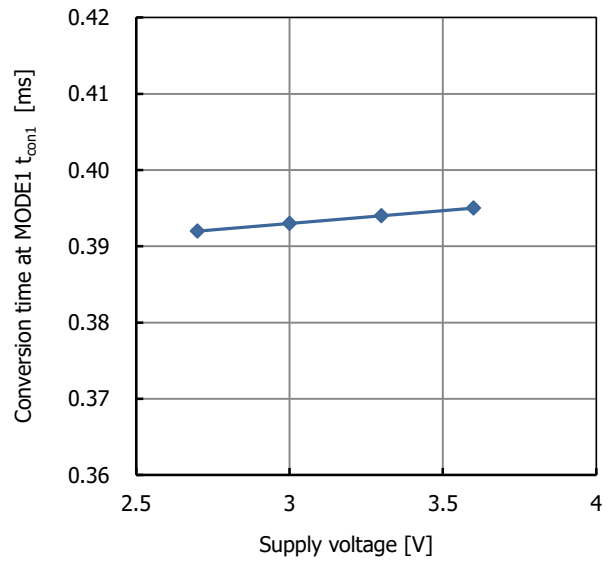

Fig. 22.10 Conversion time at MODE 1 supply voltage characteristic

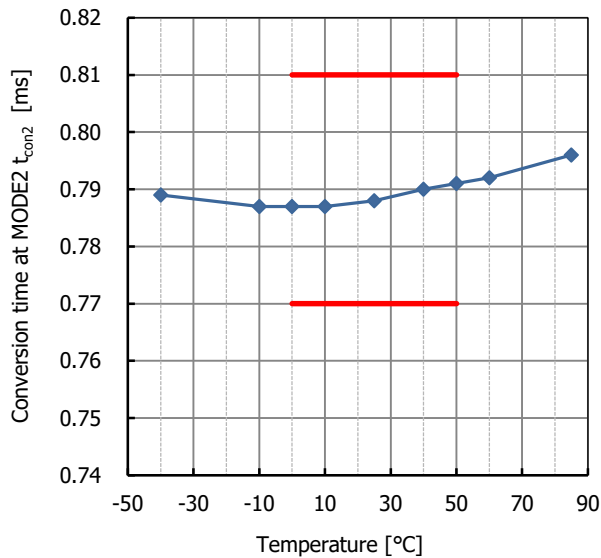

Fig. 22.12 Conversion time at MODE 2 temperature characteristic

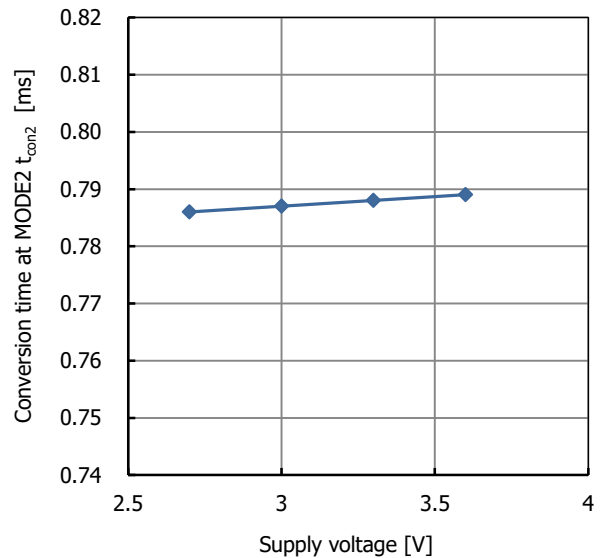

Fig. 22.11 Conversion time at MODE 2 supply voltage characteristic

(unless otherwise specified, $T_a=25^\circ\text{C}$, $V_{DD}=V_{DDIO}=3.3\text{V}$)

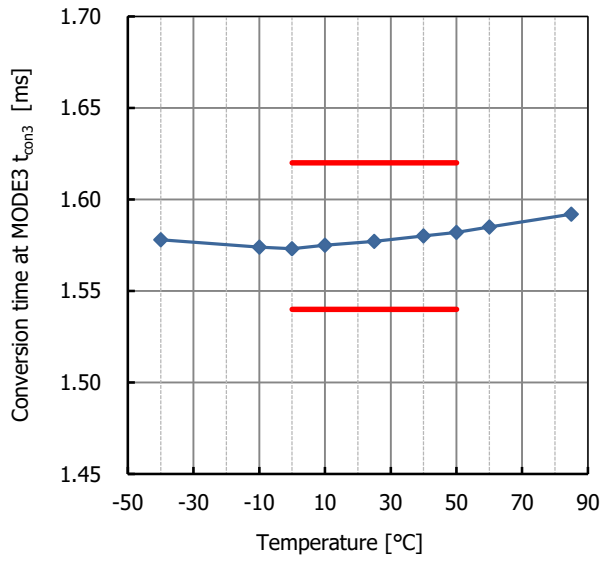

Fig. 22.14 Conversion time at MODE 3 temperature characteristic

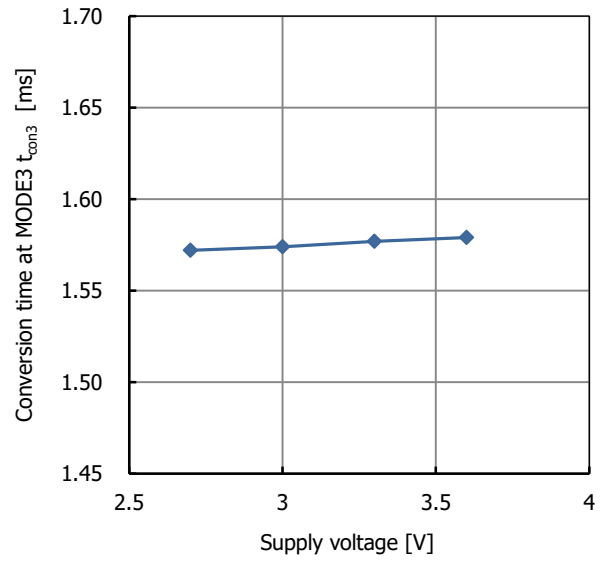

Fig. 22.13 Conversion time at MODE 3 supply voltage characteristic

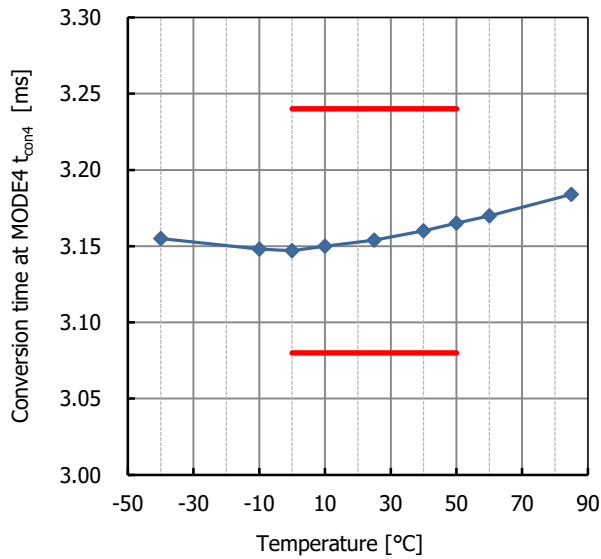

Fig. 22.16 Conversion time at MODE 4 temperature characteristic

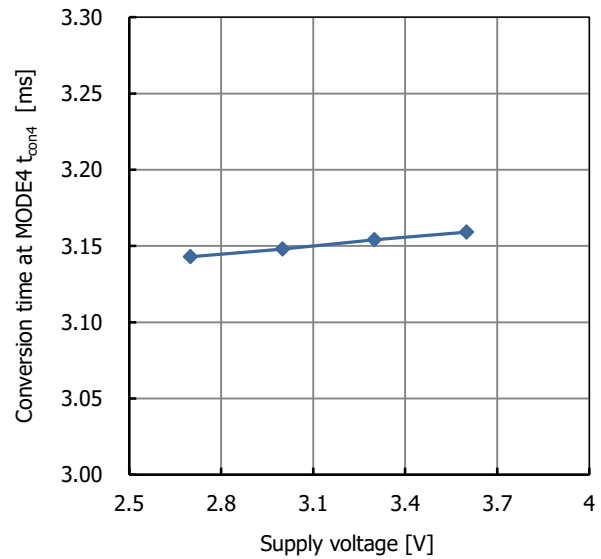

Fig. 22.15 Conversion time at MODE 4 supply voltage characteristic

(unless otherwise specified, Ta=25°C, VDD=VDDIO=3.3V)

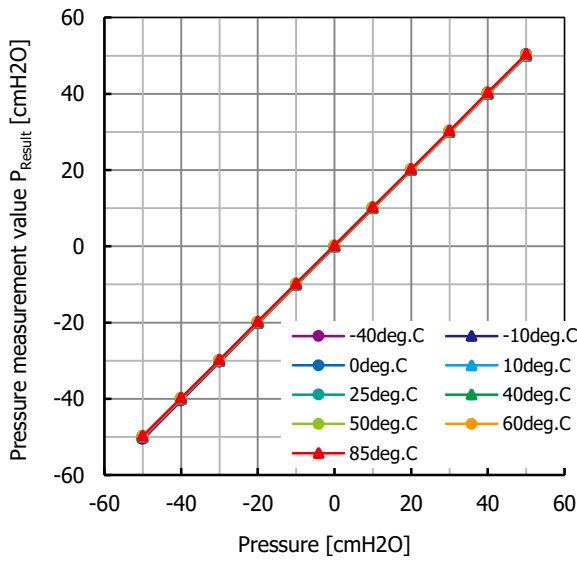

Fig. 22.17 Pressure measurement value P_{Result} temperature characteristic

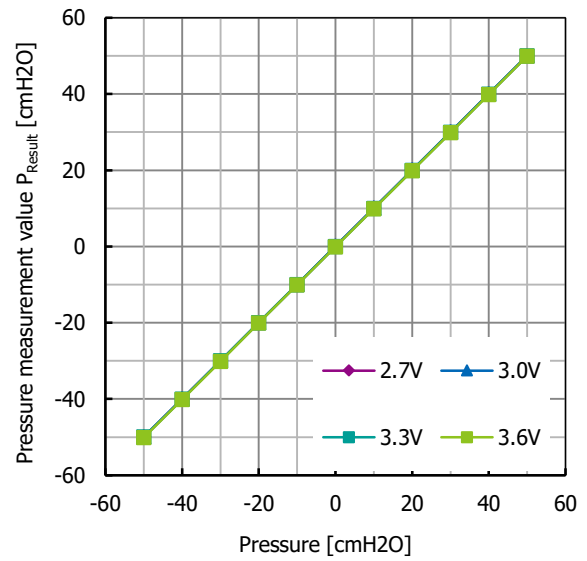

Fig. 22.18 Pressure measurement value P_{Result} supply voltage characteristic

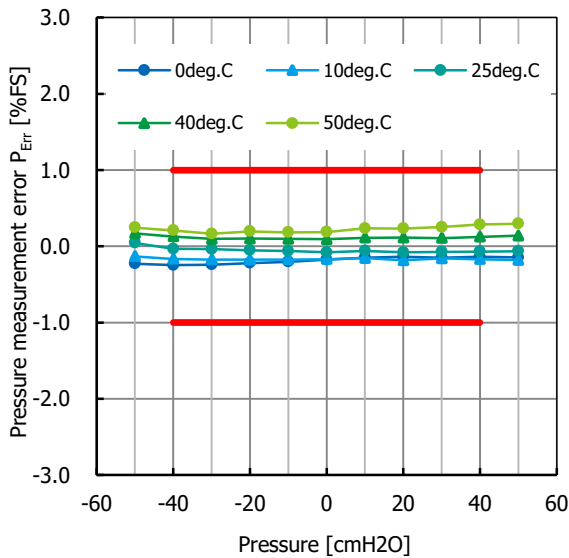

Fig. 22.19 Pressure measurement error P_{Err} temperature characteristic 0~50deg.C

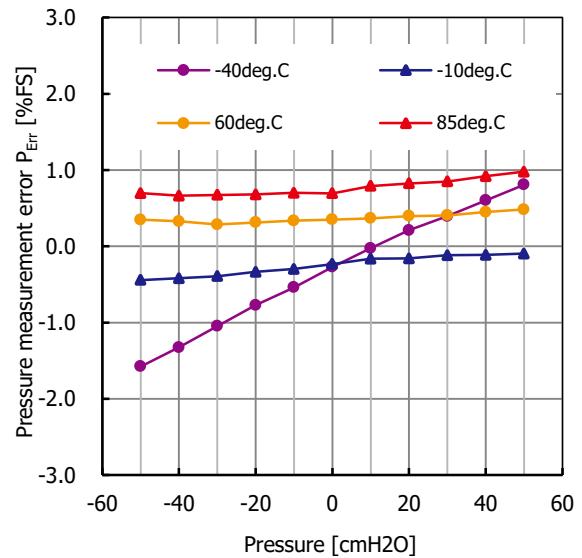

Fig. 22.20 Pressure measurement error P_{Err} temperature characteristic -40~85deg.C

(unless otherwise specified, $T_a=25^\circ\text{C}$, $V_{DD}=V_{DDIO}=3.3\text{V}$)

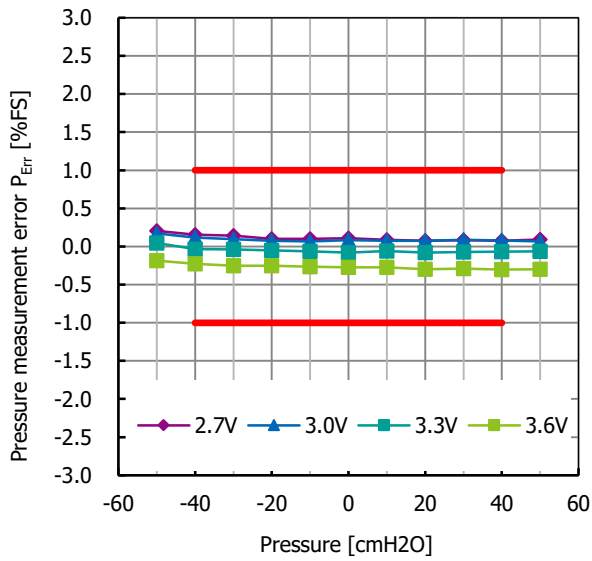

Fig. 22. SEQ22.21Err
supply voltage characteristic

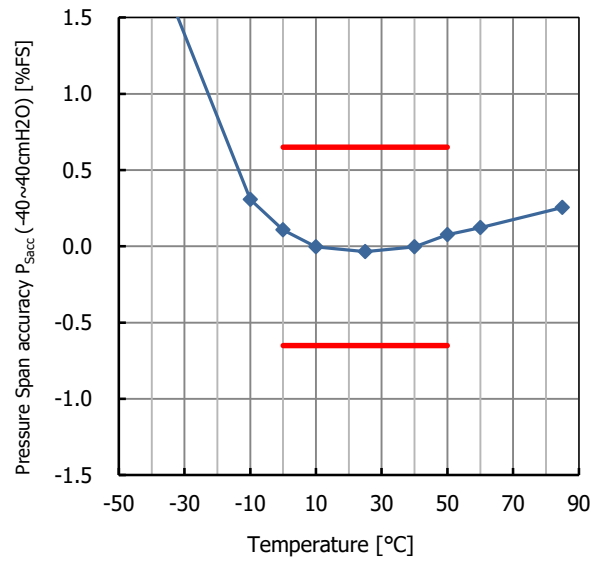

Fig. 22. SEQ22.22
temperature characteristic

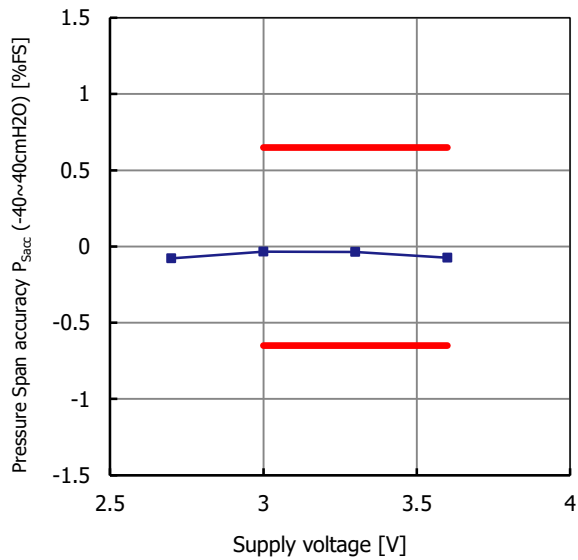

Fig. 22. SEQ22.23
supply voltage characteristic

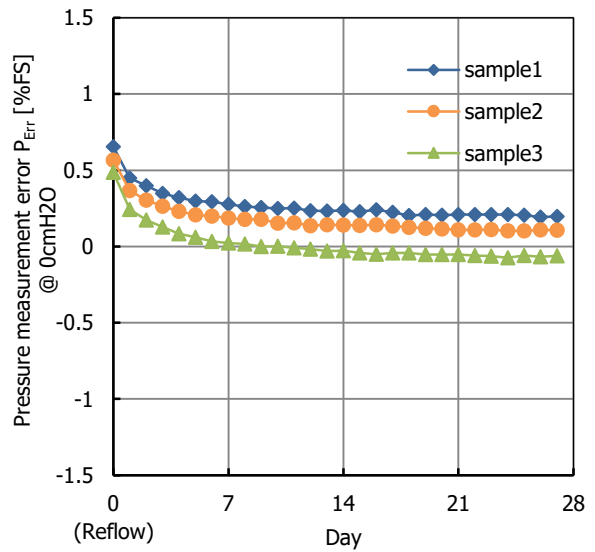

Fig. 22. SEQ22.24Err
@0cmH2O Reflow drift

NOTES

Safety Precautions

- Though Mitsumi Electric Co., Ltd. (hereinafter referred to as "Mitsumi") works continually to improve our product's quality and reliability, semiconductor products may generally malfunction or fail. Customers are responsible for complying with safety standards and for providing adequate designs and safeguards for their hardware, software and systems which minimize risk and avoid situations in which a malfunction or failure of this product could cause loss of human life, bodily injury, or damage to property, including data loss or corruption. Before customers use this product, create designs including this product, or incorporate this product into their own applications, customers must also refer to and comply with (a) the latest versions or all of our relevant information, including without limitation, product specifications, data sheets and application notes for this product and (b) the user's manual, handling instructions or all relevant information for any products which is to be used, or combined with this products. Customers are solely responsible for all aspects of their own product design or applications, including but not limited to (a) determining the appropriateness of the use of this product in such design or applications; (b) evaluating and determining the applicability of any information contained in this document, or in charts, diagrams, programs, algorithms, sample application circuits, or any other referenced documents; and (c) validating all operating parameters for such designs and applications. Mitsumi assumes no liability for customers' product design or applications.
- This product is intended for applying to computers, OA units, communication units, instrumentation units, machine tools, industrial robots, AV units, household electrical appliances, and other general electronic units.
- If you have any intentions to apply this product to the units related to the control and safety of transportation units (vehicles, trains, etc.), traffic signaling units, disaster-preventive & burglar-proof units, or the like, contact our sales representatives in advance.
- Don't apply this product to any aeronautical & space systems, submarine repeaters, nuclear power controllers, medical units involving the human life, or the like.
- Before using this product, even when it is not used for the usage written above, notify and present us beforehand if special care and attention are needed for its application, intended purpose, environment of usage, risk, and the design or inspection specification corresponding to them.
- If any damage to our customer is objectively identified to be caused by the defect of this product, Mitsumi is responsible for it. In this case, Mitsumi is liable for the cost limited to the delivery price of this product.

Application considerations during actual circuit design

- The outline of parameters described herein has been chosen as an explanation of the standard parameters and performance of the product. When you actually plan to use the product, please ensure that the outside conditions are reflected in the actual circuit and assembling designs.
- Before using this product, please evaluate and confirm the actual application with this product mounted and embedded.
- To investigate the influence by applied transient load or external noise, It is necessary to evaluate and confirm them with mounting this product to the actual application.
- Any usage above the maximum rating may destroy this product or shorten the lifetime. Be sure to use this product under the maximum rating.
- If you continue to use this product highly-loaded (applying high temperature, large current or high voltage; or variation of temperature) even under the absolute maximum rating and even in the operating range, the reliability of this product may decrease significantly. Please design appropriate reliability in consideration of power dissipation and voltage corresponding to the temperature and designed lifetime after confirming our individual reliability documents (such as reliability test report or estimated failure rate). It is recommended that, before using this product, you appropriately derate the maximum power dissipation (typically, 80% or less of the maximum value) considering parameters including ambient temperature, input voltage, and output current.

Precautions for Foreign Exchange and Foreign Trade Control Act

- If you export or take products and technologies in this document which are subject to security trade control based on the Foreign Exchange and Foreign Trade Act to overseas from Japan, permission of the Japanese government is required.

Prohibitions for Industrial Property Rights

- Since this document contains the contents related to our copyright and know-how, you are requested not to use this document for any purpose other than the application of this product.
- If a use of this product causes a dispute related to the industrial property rights of a third party, Mitsumi has no liability for any disputes except those which arise directly from the manufacturing and manufacturing method of our products.

Precautions for Product Liability Act

- No responsibility is assumed by us for any consequence resulting from any wrong or improper use or operation, etc. of this product.

Others

- Any part of the contents contained herein must not be reprinted or reproduced without our prior permission.
- In case of any question arises out of the description in this specification, it shall be settled by the consultation between both parties promptly.

ATTENTION

- This product is designed and manufactured with the intention of normal use in general electronics. No special circumstance as described below is considered for the use of it when it is designed. With this reason, any use and storage under the circumstances below may affect the performance of this product. Prior confirmation of performance and reliability is requested to customers.
 - Environment with strong static electricity or electromagnetic wave
 - Environment with high temperature or high humidity where dew condensation may occur
- This product is not designed to withstand radioactivity, and must avoid using in a radioactive environment.

ADDITIONAL NOTES

- The pressure medium which can use directly is only air. Please do not use other media, especially corrosive gases (organic solvent gas, sulfurous acid gas, hydrogen sulfide gas, etc.) and media which include moisture and foreign substance, since they could cause damages or malfunctions.
- Please handle it noting the foreign body mixing with the pressure opening and atmospheric pressure opening after opening packing.
- When cut folding the PCB after mounting this product, take measures to prevent stress to the package. Also, when you insert the tube in this product, please note that plugging it vertically. Load in the lateral direction of the cover of the nozzle is up to 1kg or less. (Load condition: position of height 4mm from the marking surface.) Excessive load could cause damages of cover, or air leak by peeling from the interface of the cover and the substrate, or malfunctions.
- The light that enters from the pressure entrance reaches the semiconductor chip. Please avoid use in the environment that light enters into the pressure entrance directly, because the semiconductor chip might malfunction because of light.

MARKING CONTENTS

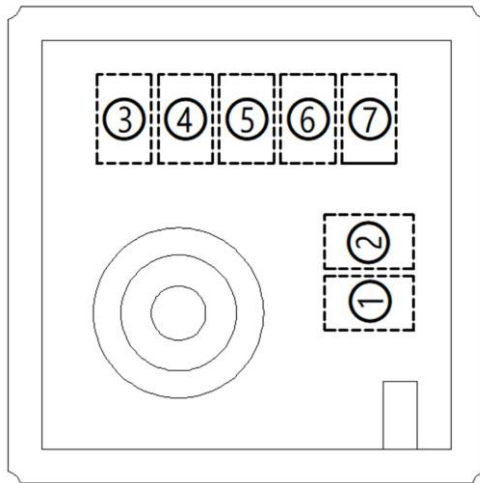

①~④	Model name		Rank	
	MMR920C04		LC04	
⑤	Production year			
⑥	Production month			
	month	marking	month	marking
	JAN	1	JUL	7
	FEB	2	AUG	8
	MAR	3	SEP	9
	APR	4	OCT	J
	MAY	5	NOV	K
	JUN	6	DEC	L
⑦	Production day			
	day	marking	day	marking
	1	1	16	G
	2	2	17	H
	3	3	18	J
	4	4	19	K
	5	5	20	L
	6	6	21	M
	7	7	22	N
	8	8	23	P
	9	9	24	R
	10	A	25	S
	11	B	26	T
	12	C	27	U
	13	D	28	V
	14	E	29	W
15	F	30	X	
		31	Y	

RECOMMENDED LAND PATTERN

UNIT	mm
------	----

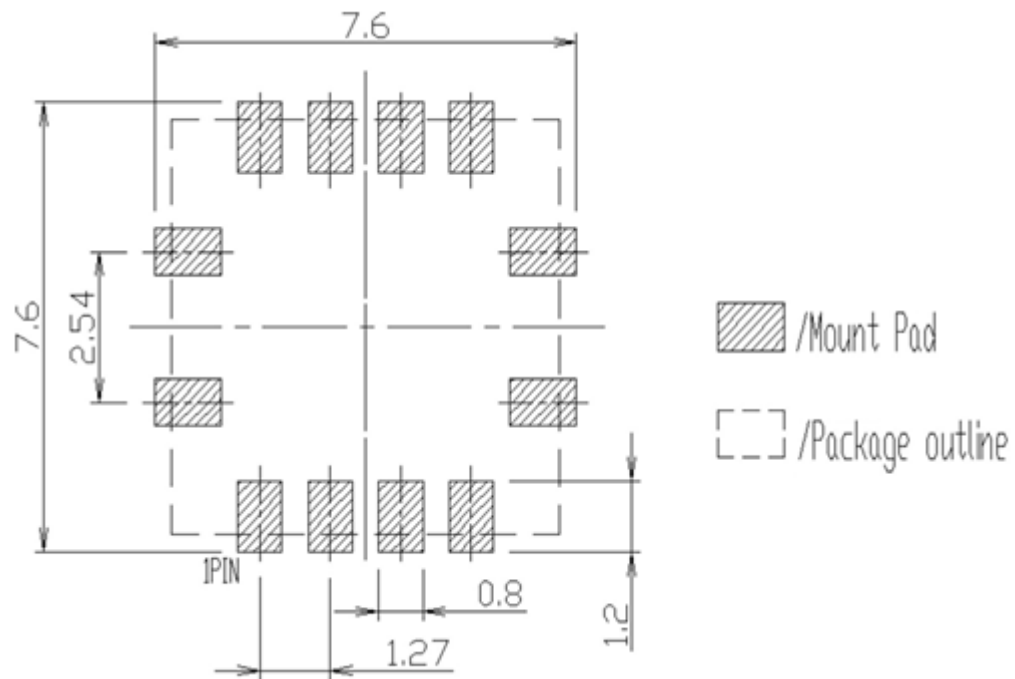

The dimension is for reference only and not guaranteed by design.

To design practically, correction should be made for optimized dimensions considering the effects of the board type to be mounted, mount (soldering) method, type and coating thickness of cream solder.

CONDITION FOR PACKAGE MOUNTING

Pb-Free recommended profile condition

Reflow Soldering (max 2times)

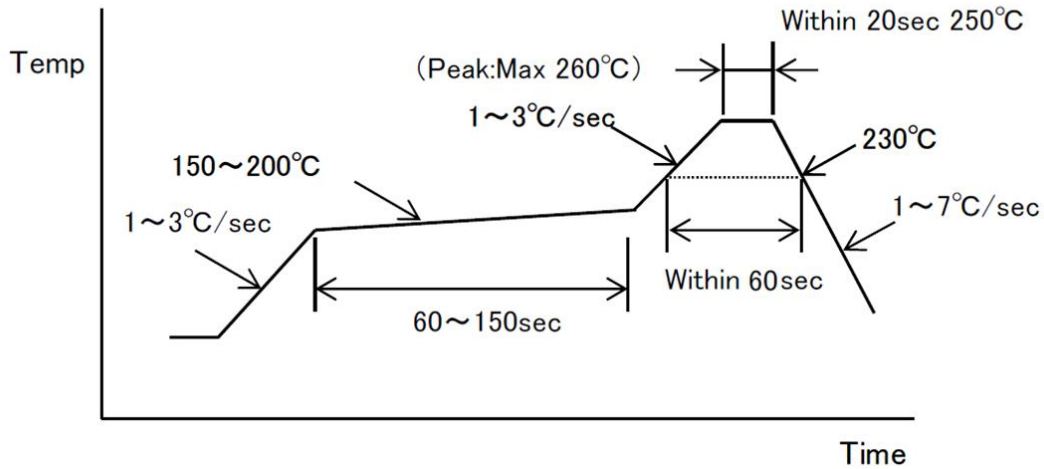

This profile gives recommended values, which are not guaranteed. For mounting the package, evaluate the profile with the equipment, conditions, and materials to be used.

- Mounting by flow soldering
Flow soldering cannot be used for mounting of this package.
- Mounting by manual soldering
Manual soldering cannot be used for mounting of this package.

In the case of cleaning, please use cotton swab, and also please keep soldering-solution from entering into the pressure and atmospheric pressure opening. Please do not use ultrasonic cleaning (dipping).

Cleaning method

Cleaning solution	Isopropyl alcohol
Solvent temperature	Max 45°C
Cleaning time	Within 3 min

Note

When insert a tube to this package, please keep direction of a tube at right angle with this package. Also, after mounting by reflow, please make sure not to insert a tube to package before finish cooling. If place an extra strain on cover nozzle, it is possible that occur cover nozzle broken, interface delamination between cover nozzle and printed wiring board. It has the potential to become air-leak problem.

Storage method

Storage condition

Store the device under the following conditions.

Temperature: 5~30°C

Humidity: 40~70%RH

Storage life: 1year

For the product in the moisture-proof packaging, follow these conditions after unpacking.

Temperature: 5~30°C

Humidity: 40~70%RH

Storage life: 168hours

Do not store this device where a large amount of dust or harmful volatile gas exists, electrostatic is easily charged, condensation is generated, or changes in temperature and humidity are wide, or under the direct sunlight.

Baking

If the storage time specified above has passed, mounting by soldering may cause cracks on the moistureabsorbed package. Before mounting, the package should be baked under the following conditions.

Temperature: 125°C

Treating time: 16 to 24 hours

Tray is not heat-resistant type.

Before baking, the device should be placed in a heat-resistant container.

In consideration of the time-consuming baking process and the possibility of deformed terminal, the device should be mounted promptly within the time observing the storage conditions.

If a long-term storage is needed, a desiccator or a dry box should be used.

Handling instructions

Shipping boxes must be handled with care because any drop or shock may damage the device. Additionally, the device must be handled in the place with the protection against electrostatic charge and without extreme changes of temperature/humidity.

This device is a piezoresistive pressure sensor. Due to its sensing principle, the output value of a piezoresistive pressure sensor is affected by thermal stress fluctuations. Therefore, after reflow soldering, the offset value of this device shifts. And the shift amount decreases gradually over time. (See the Fig. below.) Please evaluate and confirm the offset shift after reflow soldering.

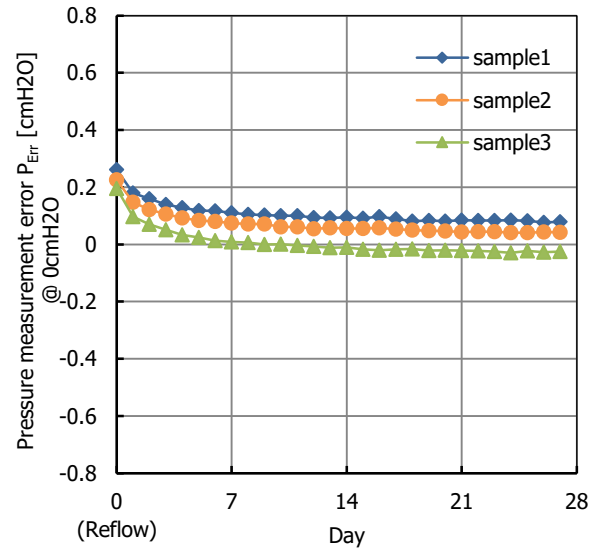

Fig. Offset Shift and Relaxation after Reflow Soldering

LINEUP

Rank	Range	Status
C02	-20 ~ +20 cmH ₂ O (-1.961 ~ +1.961 kPa)	TS Sample Ready
C04	-40 ~ +40 cmH ₂ O (-3.922 ~ +3.922 kPa)	ES Sample Ready
C07	-70 ~ +70 cmH ₂ O (-6.864 ~ +6.864 kPa)	TS Sample Ready
C10	-100 ~ +100 cmH ₂ O (-9.806 ~ +9.806 kPa)	TS Sample Ready

MITSUMI ELECTRIC CO.,LTD.

Strategy Engineering Department Semiconductor Business Division

Tel: +81-46-230-3470 / <http://www.mitsumi.co.jp>

Notes:

Any products mentioned this datasheet are subject to any modification in their appearance and others for improvements without prior notification. The details listed here are not a guarantee of the individual products at the time of ordering. When using the products, you will be asked to check their specifications.

The contents of this document are subject to change without notice.

©2020 Mitsumi co., Ltd. All rights reserved.

MITSUMI ELECTRIC CO., LTD. Semiconductor Div.

https://www.mitsumi.co.jp/latest/Catalog/index/index_e.html