

May.1.2023 Copyright 2023 HIROSE ELECTRIC CO., LTD. All Rights Reserved.
In case of consideration for using Automotive equipment / device which demand high reliability, kindly contact our sales window

△數 COUNT	訂正事項 DESCRIPTION OF REVISIONS	擔當 B Y	檢圖 CHKD	年月日 DATE	△數 COUNT	訂正事項 DESCRIPTION OF REVISIONS	擔當 B Y	檢圖 CHKD	年月日 DATE
①	1 RE-6-1150	K.I.Y	L.S.M	18. 07. 04	△				
②	1 RE-6-1579	K.I.Y	L.S.M	20. 01. 23	△				
△					△				

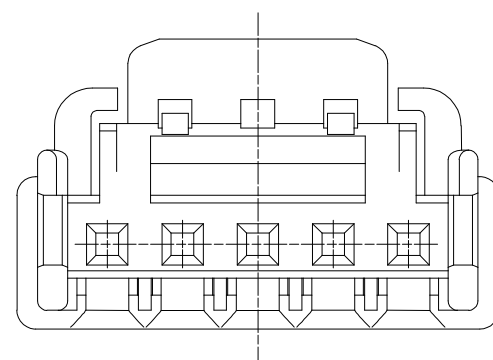

NOTE 1. 1PACK CONTAINS 100PCS.
 △2. UL(File No. E132750) AUTHORIZATION ARTICLE.
 C-UL(File No. E132750) AUTHORIZATION ARTICLE.

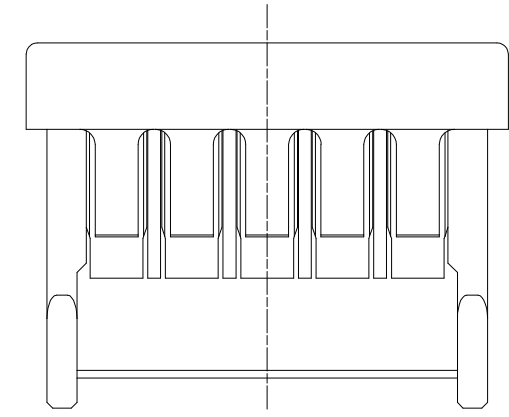
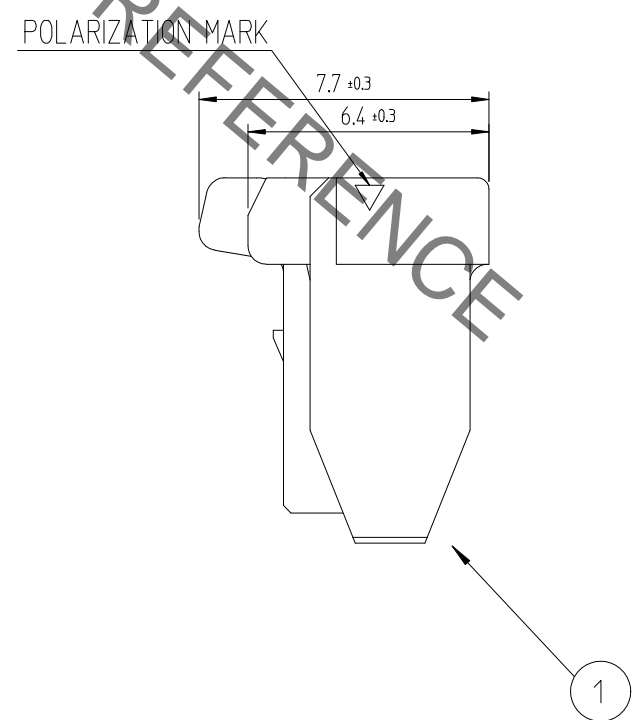
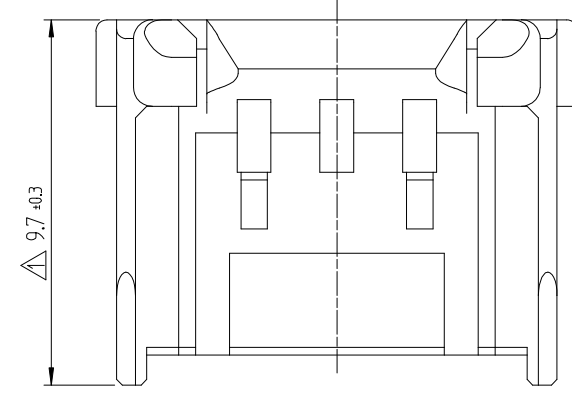
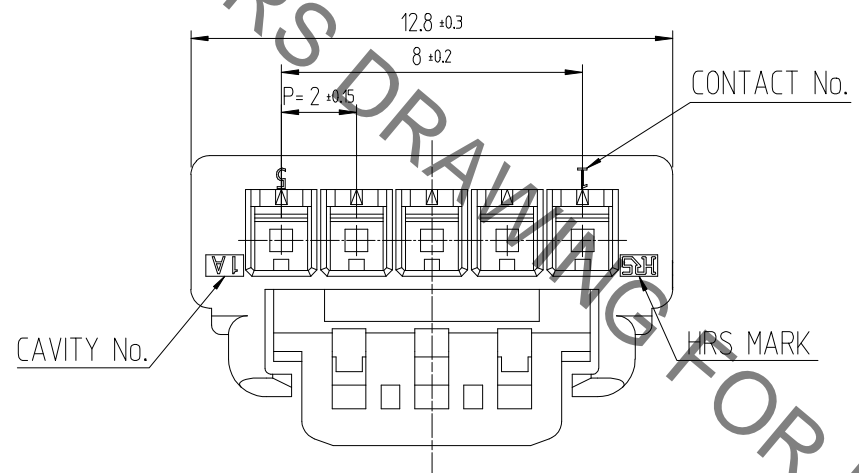

NO.	MATERIAL	FINISH,REMARKS	NO.	MATERIAL	FINISH,REMARKS
			1	PBT	UL94V-0, BLACK
CODE NO. (OLD)			DRAWN	DESIGNED	CHECKED
			CHOI 17.12.22 J.S	CHOI 17.12.22 J.S	LIM 17.12.22 S.M
			APPROVED		RELEASED
			KANG 17.12.22 T.S		ENG 20.02.12 DEPT
DRAWING NO. EDC3-632505		PART NO. DF51K-5S-2C (800)			
SCALE 5:1		CODE NO. CL 6652-0023-4-800		1/1	
UNITS mm		HRS HIROSE KOREA CO.,LTD.			