

# CAT3200HU2

## Low Noise Regulated Charge Pump DC-DC Converter

### Description

The CAT3200HU2 is a switched capacitor boost converter that delivers a low noise, regulated output voltage. The CAT3200HU2 gives a fixed regulated 5 V output when the FB pin is tied to ground, otherwise it provides an adjustable output using external resistors. The constant frequency 2 MHz charge pump allows small 1  $\mu$ F ceramic capacitors to be used.

Maximum output loads of up to 100 mA can be supported over a wide range of input supply voltages making the device ideal for battery-powered applications.

A shutdown control input allows the device to be placed in power-down mode, reducing the supply current to less than 1  $\mu$ A.

In the event of short circuit or overload conditions, the device is fully protected by both foldback current limiting and thermal overload detection. In addition, a soft start, slew rate control circuit limits inrush current during power-up.

The CAT3200HU2 is available in the tiny 8-pad UDFN 2 mm x 2 mm package.

### Features

- Constant High Frequency (2 MHz) Operation
- 100 mA Output Current
- Regulated Output Voltage (5 V Fixed or Adjustable)
- Low Quiescent Current (1.7 mA Typ.)
- Soft Start, Slew Rate Control
- Reverse Leakage Protection
- Thermal Overload Shutdown Protection
- Low Value External Capacitors (1  $\mu$ F)
- Foldback Current Overload Protection
- Shutdown Current less than 1  $\mu$ A
- 8-pad UDFN 2 mm x 2 mm Package
- These Devices are Pb-Free, Halogen Free/BFR Free and are RoHS Compliant

### Typical Applications

- 3 V to 5 V Boost Conversion
- 2.5 V to 3.3 V Boost Conversion
- White LED Driver
- Handheld Portable Devices



ON Semiconductor®

<http://onsemi.com>



UDFN-8  
HU2 SUFFIX  
CASE 517AW

### MARKING DIAGRAM

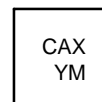

CA = Product Name  
X = Assembly Location  
Y = Production Year (Last Digit)  
M = Production Month (1–9, O, N, D)

### PIN CONNECTIONS

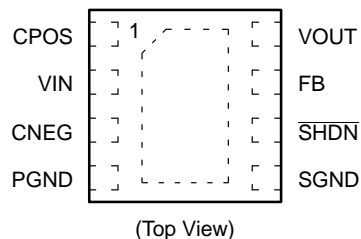

### ORDERING INFORMATION

See detailed ordering and shipping information in the package dimensions section on page 2 of this data sheet.

# CAT3200HU2

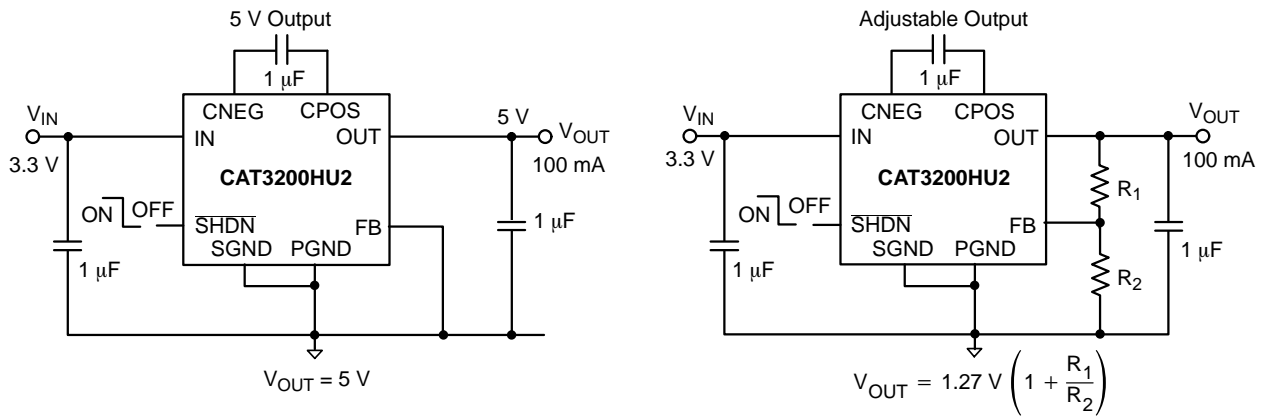

Figure 1. Typical Application Circuits

Table 1. ORDERING INFORMATION

Orderable Part Number	Output Voltage	Package	Lead Finish	Shipping (Note 1)
CAT3200HU2-GT3	5 V and Adjustable	UDFN-8	NiPdAu	3,000

1. For information on tape and reel specifications, including part orientation and tape sizes, please refer to our Tape and Reel Packaging Specifications Brochure, BRD8011/D.

Table 2. PIN FUNCTION DESCRIPTION

Pin No.	Pin Name	Description
1	CPOS	Positive connection for the flying capacitor
2	VIN	Input power supply
3	CNEG	Negative connection for the flying capacitor
4	PGND	Power ground
5	SGND	Ground reference for all voltages
6	SHDN	Shutdown control logic input (Active LOW)
7	FB	Feedback to set the output voltage
8	VOUT	Regulated output voltage
	Tab	Connect to ground on PCB

Table 3. ABSOLUTE MAXIMUM RATINGS

Rating	Value	Unit
V <sub>IN</sub> , V <sub>FB</sub> , SHDN, C <sub>NEG</sub> , C <sub>POS</sub> Voltage	-0.6 to +6	V
V <sub>OUT</sub>	-0.6 to +7	V
V <sub>OUT</sub> Short Circuit Duration	Indefinite	
Output Current	200	mA
ESD Protection (HBM)	2000	V
Junction Temperature Range	150	°C
Storage Temperature Range	-65 to +160	°C
Lead Soldering Temperature (10 sec)	300	°C

Stresses exceeding those listed in the Maximum Ratings table may damage the device. If any of these limits are exceeded, device functionality should not be assumed, damage may occur and reliability may be affected.

# CAT3200HU2

**Table 4. RECOMMENDED OPERATING CONDITIONS**

Parameter	Conditions	Symbol	Min	Typ	Max	Unit
Input Voltage	5 V output	$V_{IN}$	2.7		4.5	V
	3.3 V adjustable output		2.2		3.0	V
$C_{IN}$ , $C_{OUT}$ , $C_{FLY}$ (Note 2)			1.0	2.2	4.7	$\mu F$
Load Current		$I_{LOAD}$			100	mA
Ambient Temperature Range		$T_{AMB}$	-40		85	$^{\circ}C$

Functional operation above the stresses listed in the Recommended Operating Ranges is not implied. Extended exposure to stresses beyond the Recommended Operating Ranges limits may affect device reliability.

2. Refer to the Application Information section of this datasheet for more details.

**Table 5. ELECTRICAL CHARACTERISTICS**

(Recommended operating conditions unless otherwise specified.  $C_{IN}$ ,  $C_{OUT}$ ,  $C_{FLY}$  are 1  $\mu F$  ceramic capacitors and  $V_{IN}$  is set to 3.6 V.)

Parameter	Conditions	Symbol	Min	Typ	Max	Units
Regulated Output	$I_{LOAD} \leq 40 \text{ mA}$ , $V_{IN} \geq 2.7 \text{ V}$ , $V_{FB} = 0 \text{ V}$	$V_{OUT}$	4.8	5.0	5.2	V
	$I_{LOAD} \leq 100 \text{ mA}$ , $V_{IN} \geq 3.1 \text{ V}$ , $V_{FB} = 0 \text{ V}$					
Line Regulation	$3.1 \text{ V} \leq V_{IN} \leq 4.5 \text{ V}$ , $I_{LOAD} = 50 \text{ mA}$ , $V_{FB} = 0 \text{ V}$	$V_{LINE}$		6		mV
Load Regulation	$I_{LOAD} = 10 \text{ mA to } 100 \text{ mA}$ , $V_{IN} = 3.6 \text{ V}$ , $V_{FB} = 0 \text{ V}$	$V_{LOAD}$		20		mV
Switching Frequency		$F_{OSC}$	1.3	2.0	2.6	MHz
Output Ripple Voltage	$I_{LOAD} = 100 \text{ mA}$ , $V_{OUT} = 5 \text{ V}$ , $C_{OUT} = 1 \mu F$ , excluding ESR on $C_{OUT}$ and PCB	$V_R$	25	30	45	mVp-p
Efficiency	$I_{LOAD} = 50 \text{ mA}$ , $V_{IN} = 3 \text{ V}$ , $V_{OUT} = 5 \text{ V}$	$\eta$	77	81	85	%
Ground Current	$I_{LOAD} = 0 \text{ mA}$ , $\overline{SHDN} = V_{IN}$	$I_{GND}$		1.6	4	mA
Shutdown Input Current	$I_{LOAD} = 0 \text{ mA}$ , $SHDN = 0 \text{ V}$	$I_{SHDN}$			1	$\mu A$
FB Voltage	Adjustable output only	$V_{FB}$	1.22	1.27	1.32	V
FB Input Current		$I_{FB}$	-50		50	nA
Open-Loop Resistance	$I_{LOAD} = 100 \text{ mA}$ , $V_{IN} = 3 \text{ V}$	$R_{OL}$		10		$\Omega$
$V_{OUT}$ Turn-on time (10% to 90%)	$I_{LOAD} = 0 \text{ mA}$ , $V_{IN} = 3 \text{ V}$	$T_{ON}$		0.5		ms
SHDN Logic High Level		$V_{IH}$	1.3			V
SHDN Logic Low Level		$V_{IL}$			0.4	V
Reverse Leakage into OUT pin	$V_{OUT} = 5 \text{ V}$ , Shutdown mode, $V_{IN} = 3.0 \text{ V}$	$I_{ROUT}$		15	30	$\mu A$
Reverse Leakage from IN pin	$V_{OUT} = 5 \text{ V}$ , Shutdown mode, $V_{IN} = 3.0 \text{ V}$	$I_{RIN}$			1	$\mu A$
Short-circuit Output	$V_{OUT} = 0 \text{ V}$	$I_{SC}$		80		mA
Thermal Shutdown		$T_{SD}$		160		$^{\circ}C$
Thermal Hysteresis		$T_{HYST}$		20		$^{\circ}C$

Product parametric performance is indicated in the Electrical Characteristics for the listed test conditions, unless otherwise noted. Product performance may not be indicated by the Electrical Characteristics if operated under different conditions.

# CAT3200HU2

## TYPICAL PERFORMANCE CHARACTERISTICS

( $V_{IN} = 3.3\text{ V}$ ,  $V_{FB} = \text{GND}$  (5 V output),  $C_{IN} = C_{OUT} = C_{FLY} = 1\ \mu\text{F}$ , [C0805C105K9RACTU],  $T_{AMB} = 25^\circ\text{C}$ )

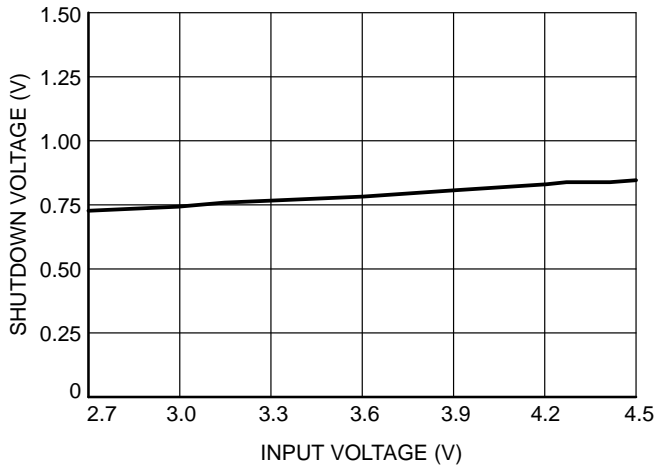

**Figure 2. Shutdown Input Threshold vs. Input Voltage**

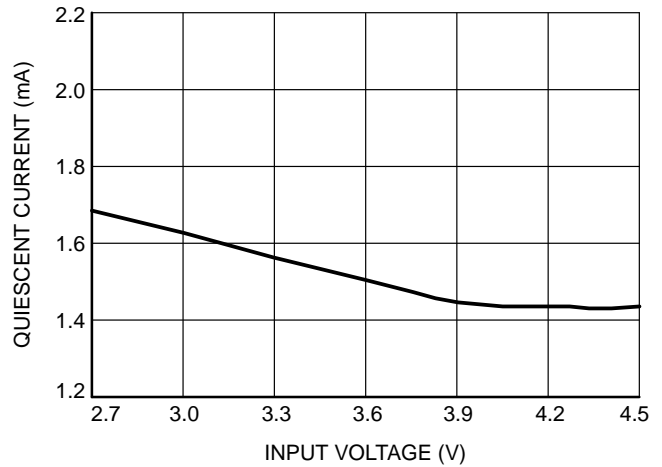

**Figure 3. Quiescent Current vs. Input Voltage (No Load)**

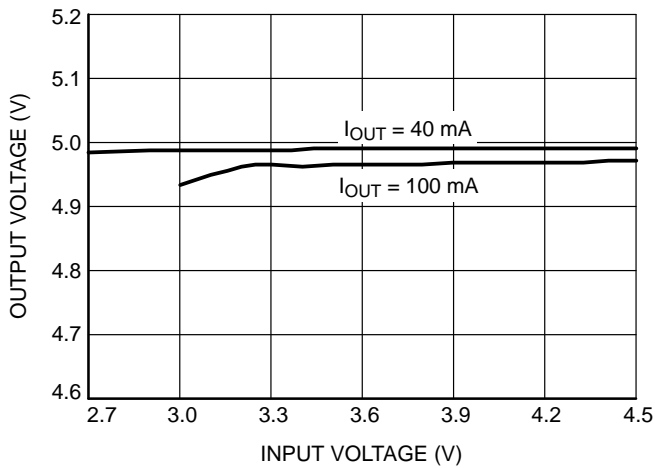

**Figure 4. Output Voltage vs. Input Voltage**

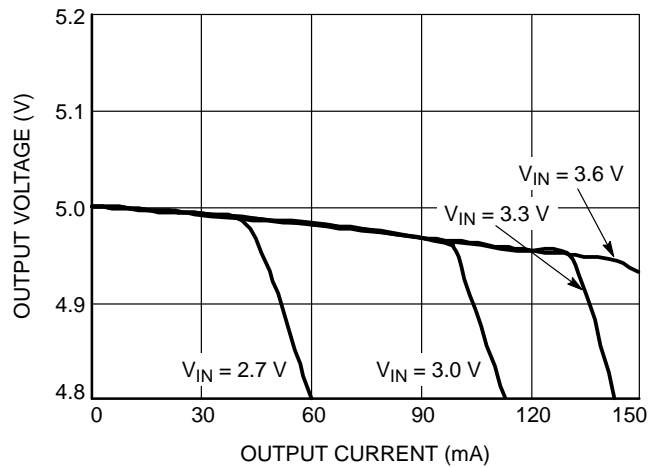

**Figure 5. Output Voltage vs. Output Current**

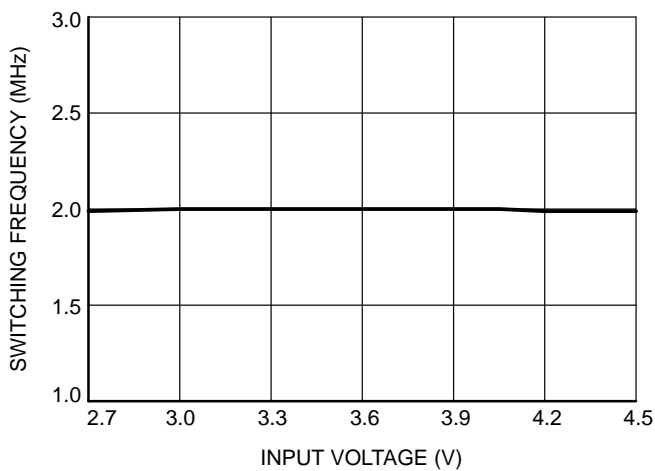

**Figure 6. Oscillator Frequency vs. Input Voltage**

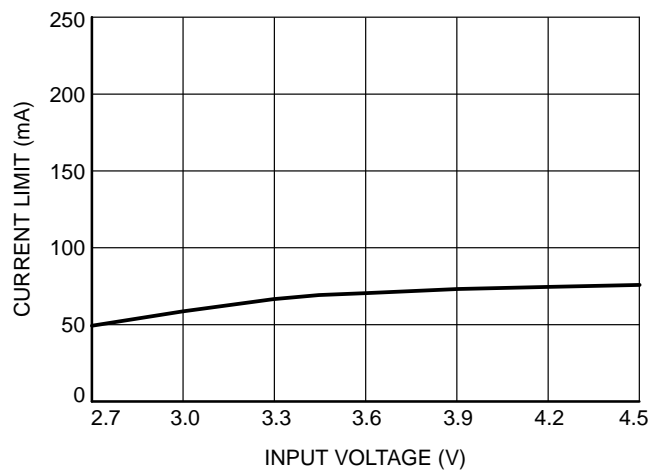

**Figure 7. Short Circuit Current vs. Input Voltage**

# CAT3200HU2

## TYPICAL PERFORMANCE CHARACTERISTICS

( $V_{IN} = 3.3\text{ V}$ ,  $V_{FB} = \text{GND}$  (5 V output),  $C_{IN} = C_{OUT} = C_{FLY} = 1\ \mu\text{F}$ , [C0805C105K9RACTU],  $T_{AMB} = 25^\circ\text{C}$ )

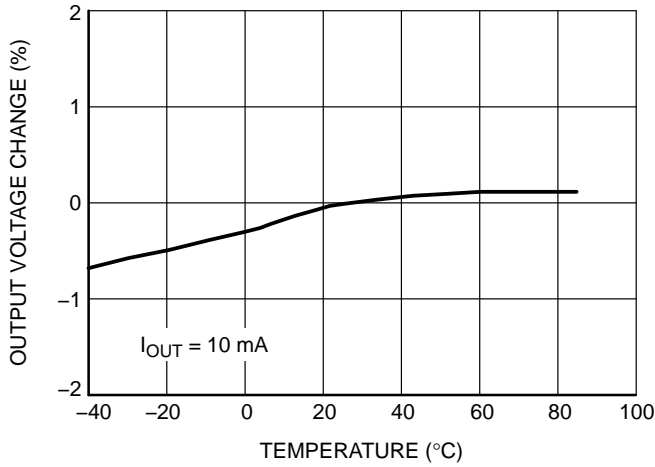

Figure 8. Output Voltage Change vs. Temperature

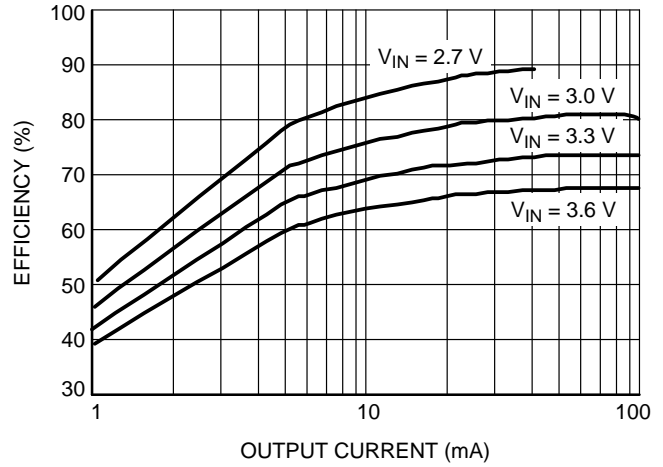

Figure 9. Efficiency vs. Output Current

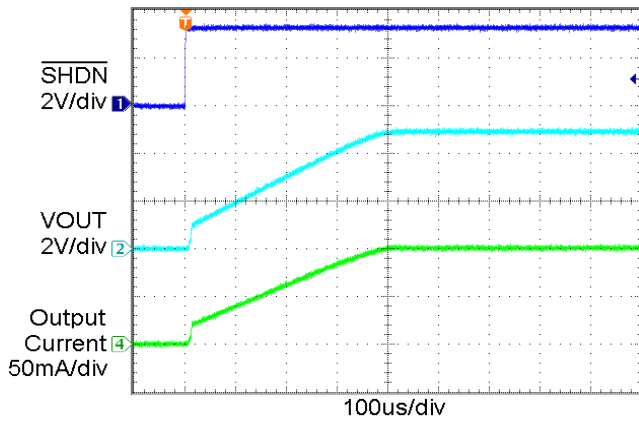

Figure 10. Power Up Waveform ( $I_{OUT} = 100\text{ mA}$ )

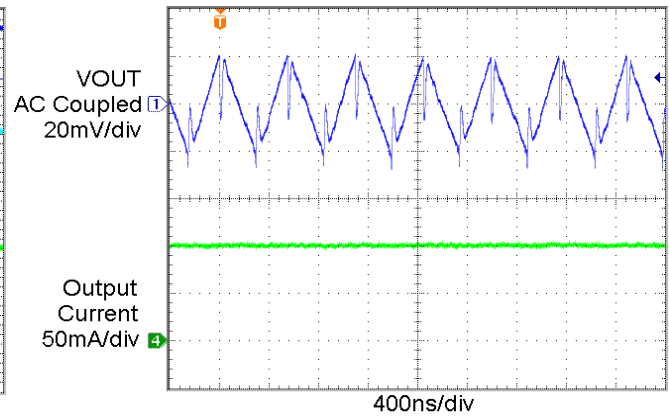

Figure 11. Output Ripple Voltage ( $I_{OUT} = 100\text{ mA}$ )

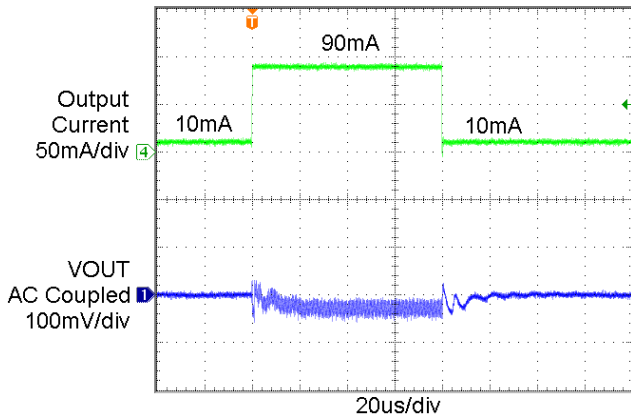

Figure 12. Load Transient Response

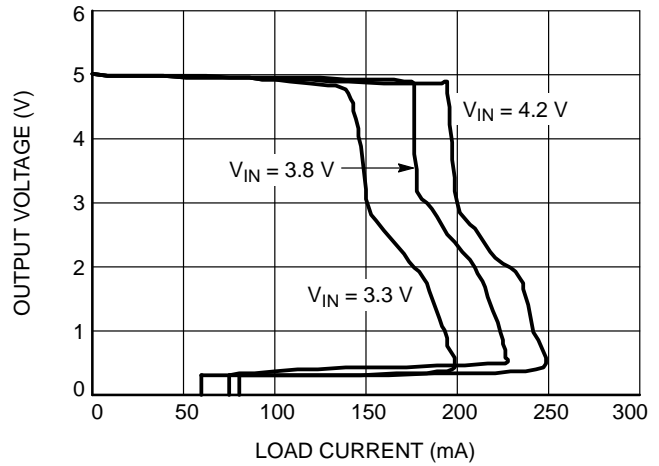

Figure 13. Foldback Current Limit

# CAT3200HU2

## TYPICAL PERFORMANCE CHARACTERISTICS

( $V_{IN} = 2.5\text{ V}$ ,  $V_{OUT} = 3.3\text{ V}$  (adjustable output),  $R1 = 16\text{ k}\Omega$ ,  $R2 = 10\text{ k}\Omega$ ,  $C_{IN} = C_{OUT} = C_{FLY} = 1\text{ }\mu\text{F}$ , [C0805C105K9RACTU],  $T_{AMB} = 25^\circ\text{C}$ )

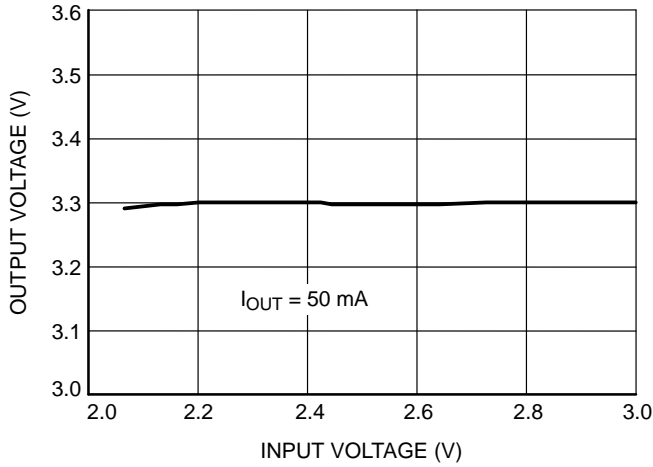

Figure 14. Output Voltage vs. Input Voltage

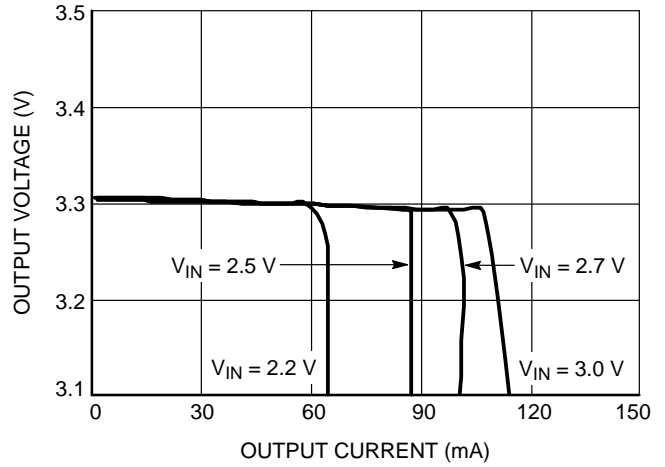

Figure 15. Output Voltage vs. Output Current

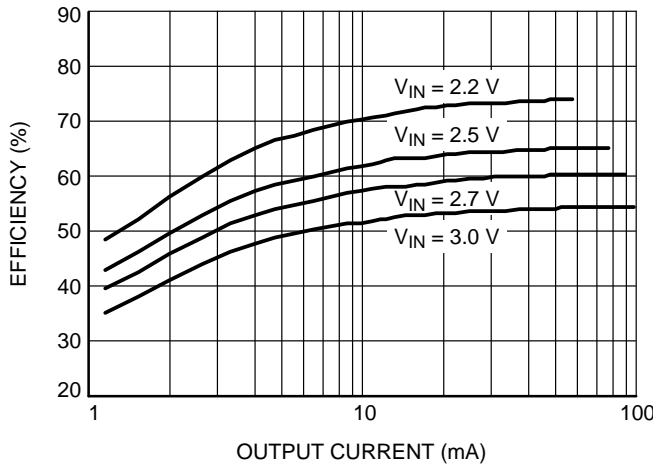

Figure 16. Efficiency vs. Output Current

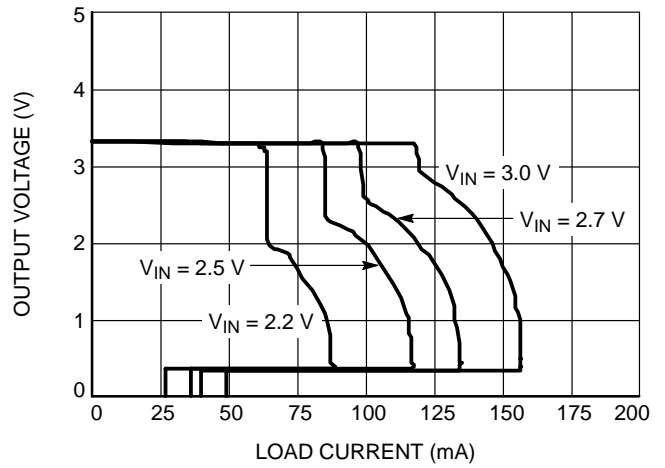

Figure 17. Foldback Current Limit

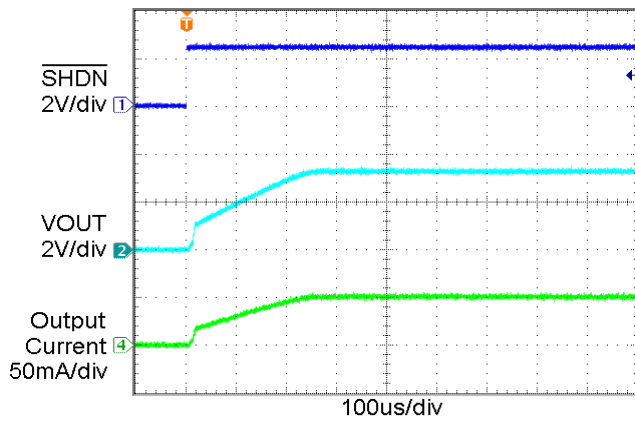

Figure 18. Power Up Waveform ( $I_{OUT} = 50\text{ mA}$ )

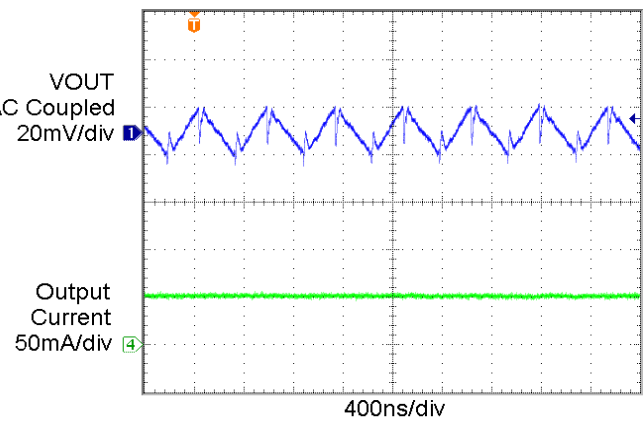

Figure 19. Output Ripple Voltage ( $I_{OUT} = 50\text{ mA}$ )

## CAT3200HU2

### Pin Functions

**VIN** is the power supply. During normal operation the device draws a supply current which is almost constant. A very brief interval of non-conduction will occur at the switching frequency. The duration of the non-conduction interval is set by the internal non-overlapping “break-before-make” timing. VIN should be bypassed with a 1 µF to 4.7 µF low ESR (Equivalent Series Resistance) ceramic capacitor.

For filtering, a low ESR ceramic bypass capacitor (1 µF) in close proximity to the IN pin prevents noise from being injected back into the power supply.

**SHDN** is the logic control input (active low) that places the device into shutdown mode. The internal logic is CMOS and the pin does not use an internal pull-down resistor. The SHDN pin should not be allowed to float.

**CPOS**, **CNEG** pins are the positive and negative connections respectively for the charge pump flying capacitor. A low ESR ceramic capacitor (1 µF) should be connected between these pins. During initial power-up it may be possible for the capacitor to experience a voltage reversal and for this reason, avoid using a polarized (tantalum or aluminum) flying capacitor.

**VOUT** is the regulated output voltage to power the load. During normal operation, the device will deliver a train of current pulses to the pin at a frequency of 2 MHz. Adequate filtering on the pin can typically be achieved through the use of a low ESR ceramic bypass capacitor (1 µF to 4.7 µF) in close proximity to the VOUT pin. The ESR of the output capacitor will directly influence the output ripple voltage.

When the shutdown mode is entered, the output is immediately isolated from the input supply, however, the output will remain connected to the internal feedback resistor network (400 kΩ). The feedback network will result in a reverse current of 10 µA to 20 µA to flow back through the device to ground.

Whenever the device is taken out of shutdown mode, the output voltage will experience a slew rate controlled power-up. Full operating voltage is typically achieved in less than 0.5 ms.

**SGND** is the ground reference for all voltages on the CAT3200HU2.

**FB** is the feedback input pin. An output divider should be connected from VOUT to FB to program the output voltage when used in adjustable output mode. When used in 5 V fixed output mode, connect the FB pin directly to GND.

**PGND** is the power ground.

### Device Operation

The CAT3200HU2 uses a switched capacitor charge pump to boost the voltage at IN to a regulated output voltage. Regulation is achieved by sensing the output voltage through an internal resistor divider (FB pin = GND) and modulating the charge pump output current based on the

error signal. A 2-phase non-overlapping clock activates the charge pump switches. The flying capacitor is charged from the IN voltage on the first phase of the clock. On the second phase of the clock it is stacked in series with the input voltage and connected to VOUT. The charging and discharging of the flying capacitor continues at a free running frequency of typically 2 MHz.

In shutdown mode all circuitry is turned off and the CAT3200HU2 draws only leakage current from the VIN supply. VOUT is disconnected from VIN. The SHDN pin is a CMOS input with a threshold voltage of approximately 0.8 V. The CAT3200HU2 is in shutdown when a logic LOW is applied to the SHDN pin. The SHDN pin is a high impedance CMOS input. SHDN does not have an internal pull-down resistor and should not be allowed to float. It must always be driven with a valid logic level.

### Short-Circuit and Thermal Protection

The CAT3200HU2 has built-in short-circuit current limiting and over temperature protection. During overload conditions, output current is limited to approximately 225 mA. At higher temperatures, or if the input voltage is high enough to cause excessive chip self heating, the thermal shutdown circuit shuts down the charge pump as the junction temperature exceeds approximately 160°C. Once the junction temperature drops back to approximately 140°C, the charge pump is enabled. The CAT3200HU2 will cycle in and out of thermal shutdown indefinitely without latch-up or damage until a short-circuit on VOUT is removed.

### Programming the CAT3200HU2 Output Voltage (FB Pin)

The CAT3200HU2 version has an internal resistive divider to program the output voltage. The programmable CAT3200HU2 may be set to an arbitrary voltage via an external resistive divider. Since it employs a voltage doubling charge pump, it is not possible to achieve output voltages greater than twice the available input voltage. Figure 20 shows the required voltage divider connection. The voltage divider ratio is given by the formula:

$$\frac{R1}{R2} = \frac{V_{OUT}}{1.27 V} - 1$$

Typical values for total voltage divider resistance can range from several kΩ up to 1 MΩ.

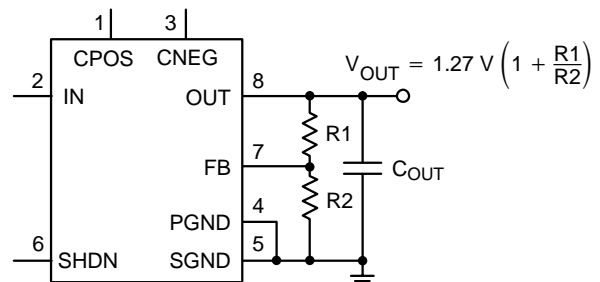

Figure 20. Programming the Adjustable Output

## Application Information

### Ceramic Capacitors

Ceramic capacitors of different dielectric materials lose their capacitance with higher temperature and voltage at different rates. For example, a capacitor made of X5R or X7R material will retain most of its capacitance from  $-40^{\circ}\text{C}$  to  $85^{\circ}\text{C}$  whereas a Z5U or Y5V style capacitor will lose considerable capacitance over that range.

Z5U and Y5V capacitors may also have voltage coefficient causing them to lose 60% or more of their capacitance when the rated voltage is applied. When comparing different capacitors it is often useful to consider the amount of achievable capacitance for a given case size rather than discussing the specified capacitance value. For example, over rated voltage and temperature conditions, a  $1\ \mu\text{F}$ , 10 V, Y5V ceramic capacitor in an 0603 case may not provide any more capacitance than a  $0.22\ \mu\text{F}$ , 10 V, X7R available in the same 0603 case. For many CAT3200HU2 applications these capacitors can be considered roughly equivalent.

### Output Ripple

The output ripple voltage is related to the output capacitor size  $C_{\text{OUT}}$  and ESR (equivalent series resistance) and can be calculated using the formula below:

$$V_{\text{R}} = I_{\text{LOAD}} / (2 \cdot F_{\text{OSC}} \cdot C_{\text{OUT}}) + 2 \cdot \text{ESR}_{\text{COUT}} \cdot I_{\text{LOAD}}$$

where  $F_{\text{OSC}}$  is the switching frequency.

### Efficiency

The efficiency is basically set by the ratio between the input voltage  $V_{\text{IN}}$  and the output voltage  $V_{\text{OUT}}$ , and can be calculated using the formula below:

$$\begin{aligned} \text{Efficiency [\%]} &= 100 \cdot P_{\text{OUT}} / P_{\text{IN}} \\ &= 100 \cdot V_{\text{OUT}} \cdot I_{\text{LOAD}} / (V_{\text{IN}} \cdot I_{\text{IN}}) \end{aligned}$$

where  $F_{\text{OSC}}$  is the switching frequency, and

$$I_{\text{IN}} = I_{\text{GND}} + 2 \cdot I_{\text{LOAD}}$$

If we neglect the Ground current ( $I_{\text{GND}}$ ), then the efficiency is basically equal to:

$$\text{Efficiency [\%]} \cong 100 \cdot V_{\text{OUT}} / (2 \cdot V_{\text{IN}})$$

### Layout Guidance

The CAT3200HU2 2 MHz switching frequency requires minimum trace length and impedance for  $C_{\text{IN}}$ ,  $C_{\text{OUT}}$ , and  $C_{\text{FLY}}$  capacitors. This can be accomplished by placing these components close to the IC. The  $C_{\text{IN}}$  capacitor ground connection can connect directly to PGND and a wide, single trace should connect PGND and SGND.  $C_{\text{OUT}}$  should be star-connected to SGND, along with FB resistor network, if used.



# MECHANICAL CASE OUTLINE

## PACKAGE DIMENSIONS

ON Semiconductor®



SCALE 2:1

UDFN8, 2x2  
CASE 517AW  
ISSUE A

DATE 13 NOV 2015

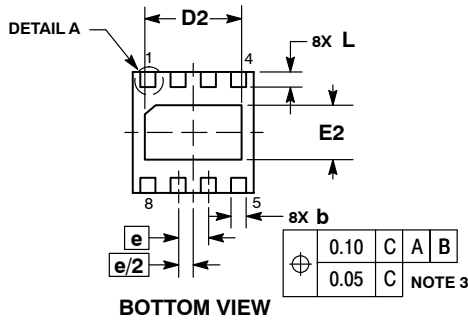
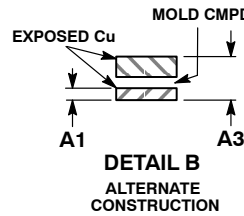
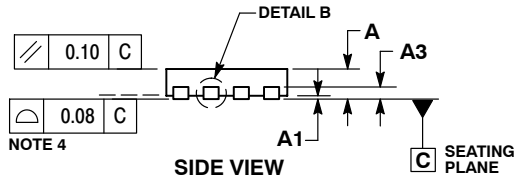
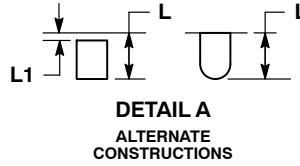
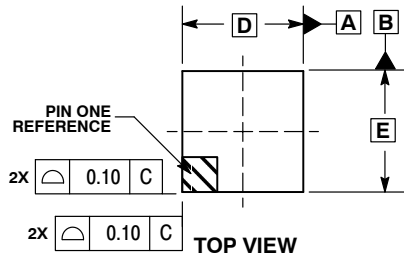

NOTES:

1. DIMENSIONING AND TOLERANCING PER ASME Y14.5M, 1994.
2. CONTROLLING DIMENSION: MILLIMETERS.
3. DIMENSION b APPLIES TO PLATED TERMINALS AND IS MEASURED BETWEEN 0.15 AND 0.30 MM FROM THE TERMINAL TIP.
4. COPLANARITY APPLIES TO THE EXPOSED PAD AS WELL AS THE TERMINALS.
5. FOR DEVICE OPN CONTAINING W OPTION, DETAIL B ALTERNATE CONSTRUCTION IS NOT APPLICABLE.

DIM	MILLIMETERS	
	MIN	MAX
A	0.45	0.55
A1	0.00	0.05
A3	0.13 REF	
b	0.18	0.30
D	2.00 BSC	
D2	1.50	1.70
E	2.00 BSC	
E2	0.80	1.00
e	0.50 BSC	
L	0.20	0.45
L1	---	0.15

GENERIC MARKING DIAGRAM\*

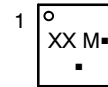

- XX = Specific Device Code
- M = Date Code
- = Pb-Free Package

(Note: Microdot may be in either location)  
\*This information is generic. Please refer to device data sheet for actual part marking. Pb-Free indicator, "G" or microdot "▪", may or may not be present.

RECOMMENDED SOLDERING FOOTPRINT\*

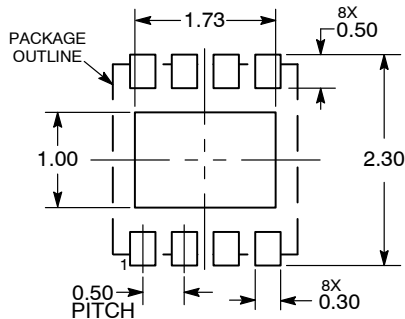

DIMENSIONS: MILLIMETERS

\*For additional information on our Pb-Free strategy and soldering details, please download the ON Semiconductor Soldering and Mounting Techniques Reference Manual, SOLDERRM/D.

DOCUMENT NUMBER:	98AON34462E	Electronic versions are uncontrolled except when accessed directly from the Document Repository. Printed versions are uncontrolled except when stamped "CONTROLLED COPY" in red.
DESCRIPTION:	UDFN8, 2X2	PAGE 1 OF 1

ON Semiconductor and ON are trademarks of Semiconductor Components Industries, LLC dba ON Semiconductor or its subsidiaries in the United States and/or other countries. ON Semiconductor reserves the right to make changes without further notice to any products herein. ON Semiconductor makes no warranty, representation or guarantee regarding the suitability of its products for any particular purpose, nor does ON Semiconductor assume any liability arising out of the application or use of any product or circuit, and specifically disclaims any and all liability, including without limitation special, consequential or incidental damages. ON Semiconductor does not convey any license under its patent rights nor the rights of others.

**onsemi**, **Onsemi**, and other names, marks, and brands are registered and/or common law trademarks of Semiconductor Components Industries, LLC dba "**onsemi**" or its affiliates and/or subsidiaries in the United States and/or other countries. **onsemi** owns the rights to a number of patents, trademarks, copyrights, trade secrets, and other intellectual property. A listing of **onsemi**'s product/patent coverage may be accessed at [www.onsemi.com/site/pdf/Patent-Marking.pdf](http://www.onsemi.com/site/pdf/Patent-Marking.pdf). **onsemi** reserves the right to make changes at any time to any products or information herein, without notice. The information herein is provided "as-is" and **onsemi** makes no warranty, representation or guarantee regarding the accuracy of the information, product features, availability, functionality, or suitability of its products for any particular purpose, nor does **onsemi** assume any liability arising out of the application or use of any product or circuit, and specifically disclaims any and all liability, including without limitation special, consequential or incidental damages. Buyer is responsible for its products and applications using **onsemi** products, including compliance with all laws, regulations and safety requirements or standards, regardless of any support or applications information provided by **onsemi**. "Typical" parameters which may be provided in **onsemi** data sheets and/or specifications can and do vary in different applications and actual performance may vary over time. All operating parameters, including "Typicals" must be validated for each customer application by customer's technical experts. **onsemi** does not convey any license under any of its intellectual property rights nor the rights of others. **onsemi** products are not designed, intended, or authorized for use as a critical component in life support systems or any FDA Class 3 medical devices or medical devices with a same or similar classification in a foreign jurisdiction or any devices intended for implantation in the human body. Should Buyer purchase or use **onsemi** products for any such unintended or unauthorized application, Buyer shall indemnify and hold **onsemi** and its officers, employees, subsidiaries, affiliates, and distributors harmless against all claims, costs, damages, and expenses, and reasonable attorney fees arising out of, directly or indirectly, any claim of personal injury or death associated with such unintended or unauthorized use, even if such claim alleges that **onsemi** was negligent regarding the design or manufacture of the part. **onsemi** is an Equal Opportunity/Affirmative Action Employer. This literature is subject to all applicable copyright laws and is not for resale in any manner.

## PUBLICATION ORDERING INFORMATION

### LITERATURE FULFILLMENT:

Email Requests to: [orderlit@onsemi.com](mailto:orderlit@onsemi.com)

**onsemi Website:** [www.onsemi.com](http://www.onsemi.com)

### TECHNICAL SUPPORT

**North American Technical Support:**

Voice Mail: 1 800-282-9855 Toll Free USA/Canada

Phone: 011 421 33 790 2910

**Europe, Middle East and Africa Technical Support:**

Phone: 00421 33 790 2910

For additional information, please contact your local Sales Representative