

|   |  |       |
|---|--|-------|
| GlobTek, Inc.<br>www.globtek.com<br>186 Veterans Drive,<br>Northvale, NJ 07647<br>Tel. (201) 784-1000<br>Fax (201) 784-0111 | Drawing Title: GTM93021-2024-P2, ICT / ITE / Medical Power Supply/Class 2/Household Power Supply, Efficiency Level: V, Case Color/Style: GlobTek Black, Potted/Encapsulated in plastic housing, Regulated Switchmode AC-DC Power Supply AC Adaptor, Input Rating: 100-240V~, 50-60 Hz, Lead Wires , Output Rating: 20W, 24.0V@0.833A, Output Configuration: 200mm +15/-0 mm, 20/1C + Shield Cond, UL 1185, Waterproof IP68 Molded Female Plug, 2 sockets, 3.0mm Pitch, Equivalent to KCC sk2/2, Ferrite: None, GlobTek Black, GT Cord # C0223, Pin Out: Pin 1 Positive (+V), Pin 2 Common, Blades/Input Cord: 200mm, 2* 18 AWG 1 conductor, UL 1015, solid, Black & White, Approvals: UKCA; CB EN/IEC 60335-1; Ukraine; GOST-R; Double Insulation; WEEE; CE; RoHS; Fuse 60335; NEMKO EN/IEC 60335-1; cETLus UL1310; PSE; VCCI; China RoHS; cETLus UL1310; 61558-1; IEC 61558-1; CB 61558-2-16; IP68; UL 1310; UL 1310; Fuse 60335; |       |
|   | Model No. GTM93021-2024-P2   |       |
|   | Part No./Ordering No. PR9QI833KC2CHM(RVB)  | Rev B |

In Addition to GlobTek Inc.'s renewed ISO9001:2015 - Quality Management System Certification, GlobTek Inc. is now certified to:

ISO13485:2016 - Medical Devices Quality Management System Certification  
ISO14001:2015 - Environmental Management System Certification

ISO Certificates are available online at <https://www.globtek.com/iso-certificates/>

The acceptance of this specification and use of the product described in this document indicates the acceptance and binding of the customer to Globtek TERMS AND CONDITIONS (attached to the end of this document), which supersede all other agreements, terms, and conditions (<https://en.globtek.com/terms-and-conditions/>).

The purchaser of this product (Customer) agrees that it is their sole responsibility to determine suitability/fitness of the product described in this specification for their application and to take precautions for protection against any hazards attendant to the handling and use of the product.

Footnote:

GlobTek Inc. will not be liable for the safety and performance of these power supplies/battery packs if unauthorized access and repair occurs. End user should consult applicable UL, CSA or EN standards for proper installation instruction.

Limitation of Use:

GlobTek products are intended for use with commercial, medical, and/or industrial equipment only. GlobTek product are not authorized for use as mission critical components in life support hazardous environment, nuclear or aircraft applications without prior written approval from the CEO of GlobTek Inc.

Contents of this document are subject to change without prior notice.

### Customer Approval of Specification:

Please approve, sign and send back to GlobTek so we can complete order processing.  
A delay in receipt of this form will delay delivery schedule.

|                                       |  |
|---------------------------------------|--|
| Company Name: _____                   | Customer P/N: _____                        |
| Quote Number: _____                   | Date: _____                                |
| Authorized Representative Name: _____ | Authorized Representative Signature: _____ |

|  |  |       |
|--|--|-------|
| GloTek, Inc.<br>www.globtek.com<br>186 Veterans Drive,<br>Northvale, NJ 07647<br>Tel. (201) 784-1000<br>Fax (201) 784-0111 | Drawing Title: GTM93021-2024-P2, ICT / ITE / Medical Power Supply/Class 2/Household Power Supply, Efficiency Level: V, Case Color/Style: GlobTek Black, Potted/Encapsulated in plastic housing, Regulated Switchmode AC-DC Power Supply AC Adaptor, Input Rating: 100-240V~, 50-60 Hz, Lead Wires , Output Rating: 20W, 24.0V@0.833A, Output Configuration: 200mm +15/-0 mm, 20/1C + Shield Cond, UL 1185, Waterproof IP68 Molded Female Plug, 2 sockets, 3.0mm Pitch, Equivalent to KCC sk2/2, Ferrite: None, GlobTek Black, GT Cord # C0223, Pin Out: Pin 1 Positive (+V), Pin 2 Common, Blades/Input Cord: 200mm, 2* 18 AWG 1 conductor, UL 1015, solid, Black & White, Approvals: UKCA; CB EN/IEC 60335-1; Ukraine; GOST-R; Double Insulation; WEEE; CE; RoHS; Fuse 60335; NEMKO EN/IEC 60335-1; cETLus UL1310; PSE; VCCI; China RoHS; cETLus UL1310; 61558-1; IEC 61558-1; CB 61558-2-16; IP68; UL 1310; UL 1310; Fuse 60335; |       |
|  | Model No. GTM93021-2024-P2   |       |
|  | Part No./Ordering No. PR9QI833KC2CHM(RVB)  | Rev B |

## REVISION HISTORY

| REV | DESCRIPTION  | SUB | DATE       | APPROVED |
|-----|--|-----|------------|----------|
| B   | Update packing dimensions: gift box and carton, Qty from 80 to 147, update label, remove IP67, iBook, Add Warning Labels 1& 2, Max temp. 50°C, Transformer Short Circuit, Transformer SMPS, added Wago connector drawing | QA  | 11/20/2013 | QA       |

### POWER SUPPLY INFORMATION

|                                |   |
|--------------------------------|---|
| TYPE                           | Potted/Encapsulated in plastic housing  |
| TECHNOLOGY                     | Regulated Switchmode AC-DC Power Supply AC Adaptor  |
| CASE COLOR                     | GlobTek Black   |
| NAMEPLATE RATED INPUT          | 100-240V~, 50-60 Hz, 0.6A Max   |
| INPUT CONFIG                   | Lead Wires  |
| WATTS                          | 20.00   |
| VOLTS OUT                      | 24.0  |
| CURRENT OUT (Amps)             | 0.833   |
| BLADE/CORD INCLUDED            | FC-Lead Wire 200 200mm, 2* 18 AWG 1 conductor, UL 1015, solid, Black & White  |
| BLADE/CORD INSTALLED           | FC-Lead Wire 200 :200mm, 2* 18 AWG 1 conductor, UL 1015, solid, Black & White   |
| INGRESS PROTECTION             | IP68  |
| GROUNDING CONFIGURATION        |   |
| EFFICIENCY LEVEL               | V   |
| OUTPUT CONFIGURATION           | 200mm +15/-0 mm, 20/1C + Shield Cond, UL 1185, Waterproof IP68 Molded Female Plug, 2 sockets, 3.0mm Pitch, Equivalent to KCC sk2/2, Ferrite: None, GlobTek Black, GT Cord # C0223 |
| OVERMOLDED                     | Yes   |
| CONNECTOR PIN OUT              | Pin 1 Positive (+V), Pin 2 Common   |
| LABEL SPECS                    | Standard GT,L-1186  |
| SPECIAL BARCODE LABEL MATERIAL | No  |
| PACK SPEC                      | Standard Potted, Individually Box.gif   |
| USER MANUAL                    |   |

|   |   |              |
|---|---|--------------|
| <p>GlobTek, Inc.<br/>www.globtek.com<br/>186 Veterans Drive,<br/>Northvale, NJ 07647<br/>Tel. (201) 784-1000<br/>Fax (201) 784-0111</p> | <p>Drawing Title: GTM93021-2024-P2, ICT / ITE / Medical Power Supply/Class 2/Household Power Supply, Efficiency Level: V, Case Color/Style: GlobTek Black, Potted/Encapsulated in plastic housing, Regulated Switchmode AC-DC Power Supply AC Adaptor, Input Rating: 100-240V~, 50-60 Hz, Lead Wires , Output Rating: 20W, 24.0V@0.833A, Output Configuration: 200mm +15/-0 mm, 20/1C + Shield Cond, UL 1185, Waterproof IP68 Molded Female Plug, 2 sockets, 3.0mm Pitch, Equivalent to KCC sk2/2, Ferrite: None, GlobTek Black, GT Cord # C0223, Pin Out: Pin 1 Positive (+V), Pin 2 Common, Blades/Input Cord: 200mm, 2* 18 AWG 1 conductor, UL 1015, solid, Black &amp; White, Approvals: UKCA; CB EN/IEC 60335-1; Ukraine; GOST-R; Double Insulation; WEEE; CE; RoHS; Fuse 60335; NEMKO EN/IEC 60335-1; cETLus UL1310; PSE; VCCI; China RoHS; cETLus UL1310; 61558-1; IEC 61558-1; CB 61558-2-16; IP68; UL 1310; UL 1310; Fuse 60335;</p> |              |
|   | <p>Model No. GTM93021-2024-P2</p>   |              |
|   | <p>Part No./Ordering No. PR9QI833KC2CHM(RVB</p>   | <p>Rev B</p> |

Notes/Modifications/Customizations (notes in this section supersede the values shown in the standard spec)  
DIMENSIONS ARE IN MM UNLESS SPECIFIED OTHERWISE

|  |  |       |
|--|--|-------|
| GloTek, Inc.<br>www.globtek.com<br>186 Veterans Drive,<br>Northvale, NJ 07647<br>Tel. (201) 784-1000<br>Fax (201) 784-0111 | Drawing Title: GTM93021-2024-P2, ICT / ITE / Medical Power Supply/Class 2/Household Power Supply, Efficiency Level: V, Case Color/Style: GlobTek Black, Potted/Encapsulated in plastic housing, Regulated Switchmode AC-DC Power Supply AC Adaptor, Input Rating: 100-240V~, 50-60 Hz, Lead Wires , Output Rating: 20W, 24.0V@0.833A, Output Configuration: 200mm +15/-0 mm, 20/1C + Shield Cond, UL 1185, Waterproof IP68 Molded Female Plug, 2 sockets, 3.0mm Pitch, Equivalent to KCC sk2/2, Ferrite: None, GlobTek Black, GT Cord # C0223, Pin Out: Pin 1 Positive (+V), Pin 2 Common, Blades/Input Cord: 200mm, 2* 18 AWG 1 conductor, UL 1015, solid, Black & White, Approvals: UKCA; CB EN/IEC 60335-1; Ukraine; GOST-R; Double Insulation; WEEE; CE; RoHS; Fuse 60335; NEMKO EN/IEC 60335-1; cETLus UL1310; PSE; VCCI; China RoHS; cETLus UL1310; 61558-1; IEC 61558-1; CB 61558-2-16; IP68; UL 1310; UL 1310; Fuse 60335; |       |
|  | Model No. GTM93021-2024-P2   |       |
|  | Part No./Ordering No. PR9QI833KC2CHM(RVB)  | Rev B |

## ELECTRICAL SPECIFICATIONS

### A) ELECTRICAL SPECIFICATIONS:

01. Input Voltage: Specified 90-264 Vac, Nameplate rated: 100-240Vac
02. Input Frequency: Specified 47-63 Hz, Nameplate rated 50-60Hz
03. Output Regulation: +/- 5% measured at the output connector
04. Line Voltage Regulation: +/- 1% typical measured at full load
05. Output Ripple (Vp-p): +/-1% or 150 mV whichever is greater, measured at 20 MHz bandwidth with 0.1 uf ceramic capacitor in parallel with 10 uf electrolytic capacitor connected at the end of the output connector at nominal line
06. Turn-ON/OFF Overshoot: 5% maximum, 1 mS typical recovery time for 25% to 50% step load
07. Turn-ON Delay: 3000 mS, maximum @ full load, nominal line
08. Hold-Up Time: 8 mS typical @ nominal input voltage and full load
09. Inrush Current: 30A maximum cold start @ 240Vac input
10. Switching Frequency: 65 KHz typical

### B) PROTECTION

01. Over-Voltage: Electronically Protected Zener clamp across the output
02. Short Circuit: Electronically Protected unit will auto recover upon removal of fault
04. Input Protection: Input line and neutral fusing

### C) SAFETY

01. Dielectric Withstand Voltage: 4242Vdc from primary to secondary
02. Touch Current: Maximum allowed values: 100uA NC(Normal condition) 500uA SFC(single fault condition)
03. Earth continuity test:<0.1 Ohm or < 0.2 Ohm when with a non-detachable Power Supply cord, Class I Only
04. ROHS 2: Complies with EU 2011/65/EU and China SJ/T 11363-2006

### D) OTHER:

01. MTBF: 200,000 Hours @ 25°C ambient temperature
02. Operating Temperature: 0°C to 50°C ambient temperature
03. Humidity: 0% to 90% relative humidity
04. Storage Temperature: -10°C to 80°C
05. Cooling: Convection

### E) ENCLOSURE

01. Housing: High impact plastic, 94V0 polycarbonate, non-vented
02. Size: 48.0 Length x 51.0 Width x 35.0 High mm +/-1.0 mm suitable for installation in North American 1-Gang Old Work Electrical Box / typical unterputz Power Supply (netzteil) for "Hohlwanddose" per VDE0606 (Einbau-Netzteil Stromversorgung für Unterputz-Installation)
03. Markings: Label and/or Pad Printed and/or Molded in the case

|   |  |       |
|---|--|-------|
| GlobTek, Inc.<br>www.globtek.com<br>186 Veterans Drive,<br>Northvale, NJ 07647<br>Tel. (201) 784-1000<br>Fax (201) 784-0111 | Drawing Title: GTM93021-2024-P2, ICT / ITE / Medical Power Supply/Class 2/Household Power Supply, Efficiency Level: V, Case Color/Style: GlobTek Black, Potted/Encapsulated in plastic housing, Regulated Switchmode AC-DC Power Supply AC Adaptor, Input Rating: 100-240V~, 50-60 Hz, Lead Wires , Output Rating: 20W, 24.0V@0.833A, Output Configuration: 200mm +15/-0 mm, 20/1C + Shield Cond, UL 1185, Waterproof IP68 Molded Female Plug, 2 sockets, 3.0mm Pitch, Equivalent to KCC sk2/2, Ferrite: None, GlobTek Black, GT Cord # C0223, Pin Out: Pin 1 Positive (+V), Pin 2 Common, Blades/Input Cord: 200mm, 2* 18 AWG 1 conductor, UL 1015, solid, Black & White, Approvals: UKCA; CB EN/IEC 60335-1; Ukraine; GOST-R; Double Insulation; WEEE; CE; RoHS; Fuse 60335; NEMKO EN/IEC 60335-1; cETLus UL1310; PSE; VCCI; China RoHS; cETLus UL1310; 61558-1; IEC 61558-1; CB 61558-2-16; IP68; UL 1310; UL 1310; Fuse 60335; |       |
|   | Model No. GTM93021-2024-P2   |       |
|   | Part No./Ordering No. PR9QI833KC2CHM(RVB)  | Rev B |

TO ADDRESS SYSTEM-LEVEL EMI CONCERNS, FERRITE CHOKES/BEADS MAY BE ADDED/REVISED UPON REQUEST. A SAMPLE KIT OF GLOBTEK'S STANDARD FERRITES IS AVAILABLE UNDER GLOBTEK P/N: EMI-MITIGATION-KIT1

FOR ADDITIONAL INFORMATION, PLEASE READ OUR WHITE PAPER AT:

<https://en.globtek.com/technical-articles/ferrite-kit-radiated-emi-suppression-kit-for-globtek-power-supplies-cable-assemblies>

INGRESS PROTECTION: IP68

GlobTek, Inc.  
 www.globtek.com  
 186 Veterans Drive,  
 Northvale, NJ 07647  
 Tel. (201) 784-1000  
 Fax (201) 784-0111

Drawing Title: GTM93021-2024-P2, ICT / ITE / Medical Power Supply/Class 2/Household Power Supply, Efficiency Level: V, Case Color/Style: GlobTek Black, Potted/Encapsulated in plastic housing, Regulated Switchmode AC-DC Power Supply AC Adaptor, Input Rating: 100-240V~, 50-60 Hz, Lead Wires , Output Rating: 20W, 24.0V@0.833A, Output Configuration: 200mm +15/-0 mm, 20/1C + Shield Cond, UL 1185, Waterproof IP68 Molded Female Plug, 2 sockets, 3.0mm Pitch, Equivalent to KCC sk2/2, Ferrite: None, GlobTek Black, GT Cord # C0223, Pin Out: Pin 1 Positive (+V), Pin 2 Common, Blades/Input Cord: 200mm, 2\* 18 AWG 1 conductor, UL 1015, solid, Black & White, Approvals: UKCA; CB EN/IEC 60335-1; Ukraine; GOST-R; Double Insulation; WEEE; CE; RoHS; Fuse 60335; NEMKO EN/IEC 60335-1; cETLus UL1310; PSE; VCCI; China RoHS; cETLus UL1310; 61558-1; IEC 61558-1; CB 61558-2-16; IP68; UL 1310; UL 1310; Fuse 60335;

Model No. GTM93021-2024-P2

Part No./Ordering No. PR9QI833KC2CHM(RVB

Rev B

Mechanical drawing

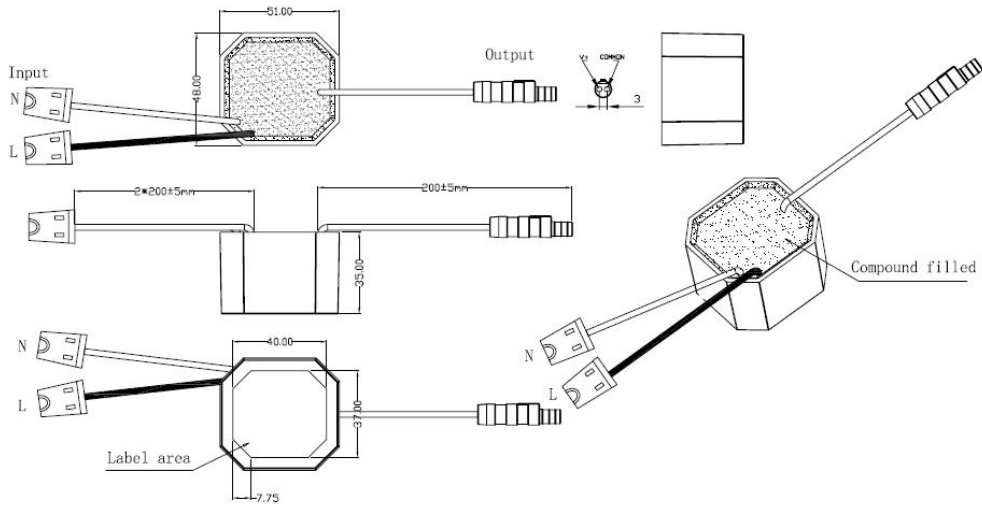

Wago connector:

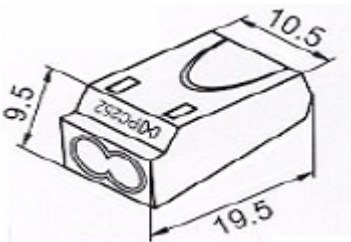

|  |   |   |
|--|---|---|
| <p>GlobTek, Inc.<br/> www.globtek.com<br/> 186 Veterans Drive,<br/> Northvale, NJ 07647<br/> Tel. (201) 784-1000<br/> Fax (201) 784-0111</p> | <p>Drawing Title: GTM93021-2024-P2, ICT / ITE / Medical Power Supply/Class 2/Household Power Supply, Efficiency Level: V, Case Color/Style: GlobTek Black, Potted/Encapsulated in plastic housing, Regulated Switchmode AC-DC Power Supply AC Adaptor, Input Rating: 100-240V~, 50-60 Hz, Lead Wires , Output Rating: 20W, 24.0V@0.833A, Output Configuration: 200mm +15/-0 mm, 20/1C + Shield Cond, UL 1185, Waterproof IP68 Molded Female Plug, 2 sockets, 3.0mm Pitch, Equivalent to KCC sk2/2, Ferrite: None, GlobTek Black, GT Cord # C0223, Pin Out: Pin 1 Positive (+V), Pin 2 Common, Blades/Input Cord: 200mm, 2* 18 AWG 1 conductor, UL 1015, solid, Black &amp; White, Approvals: UKCA; CB EN/IEC 60335-1; Ukraine; GOST-R; Double Insulation; WEEE; CE; RoHS; Fuse 60335; NEMKO EN/IEC 60335-1; cETLus UL1310; PSE; VCCI; China RoHS; cETLus UL1310; 61558-1; IEC 61558-1; CB 61558-2-16; IP68; UL 1310; UL 1310; Fuse 60335;</p> | <p>Model No. GTM93021-2024-P2</p> <hr/> <p>Part No./Ordering No. PR9QI833KC2CHM(RVB) <span style="float: right;">Rev B</span></p> |
|--|---|---|

DERATING CURVE

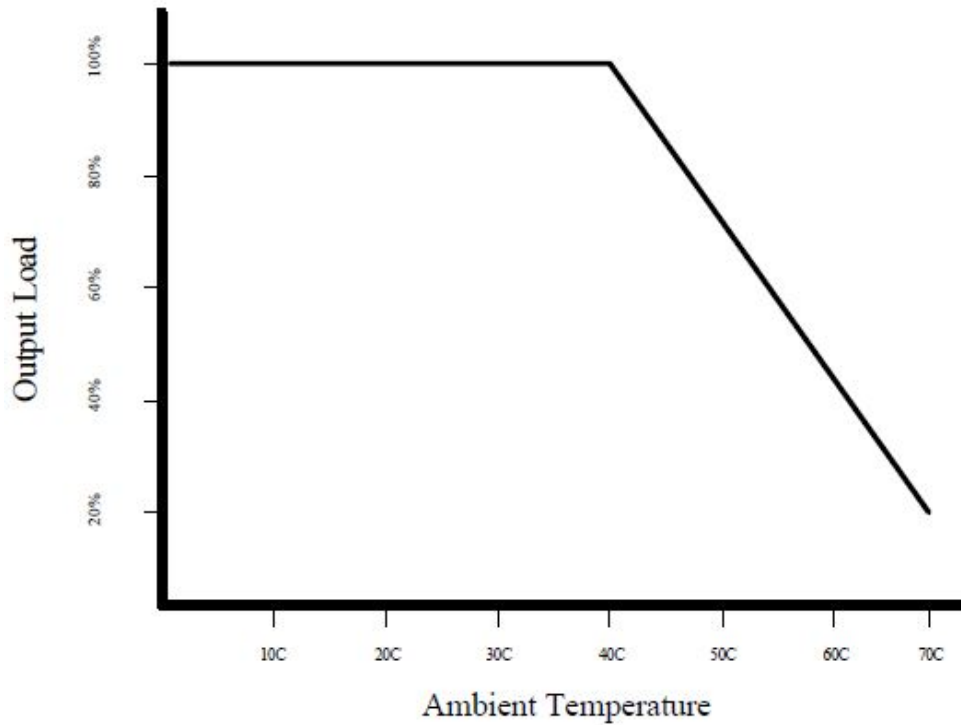

|   |  |       |
|---|--|-------|
| GlobTek, Inc.<br>www.globtek.com<br>186 Veterans Drive,<br>Northvale, NJ 07647<br>Tel. (201) 784-1000<br>Fax (201) 784-0111 | Drawing Title: GTM93021-2024-P2, ICT / ITE / Medical Power Supply/Class 2/Household Power Supply, Efficiency Level: V, Case Color/Style: GlobTek Black, Potted/Encapsulated in plastic housing, Regulated Switchmode AC-DC Power Supply AC Adaptor, Input Rating: 100-240V~, 50-60 Hz, Lead Wires , Output Rating: 20W, 24.0V@0.833A, Output Configuration: 200mm +15/-0 mm, 20/1C + Shield Cond, UL 1185, Waterproof IP68 Molded Female Plug, 2 sockets, 3.0mm Pitch, Equivalent to KCC sk2/2, Ferrite: None, GlobTek Black, GT Cord # C0223, Pin Out: Pin 1 Positive (+V), Pin 2 Common, Blades/Input Cord: 200mm, 2* 18 AWG 1 conductor, UL 1015, solid, Black & White, Approvals: UKCA; CB EN/IEC 60335-1; Ukraine; GOST-R; Double Insulation; WEEE; CE; RoHS; Fuse 60335; NEMKO EN/IEC 60335-1; cETLus UL1310; PSE; VCCI; China RoHS; cETLus UL1310; 61558-1; IEC 61558-1; CB 61558-2-16; IP68; UL 1310; UL 1310; Fuse 60335; |       |
|   | Model No. GTM93021-2024-P2   |       |
|   | Part No./Ordering No. PR9QI833KC2CHM(RVB)  | Rev B |

**INPUT CONFIGURATION**

[Alternate grounding configurations](#) available upon request.

Blades/Cord Included:FC-Lead Wire 200:200mm, 2\* 18 AWG 1 conductor, UL 1015, solid, Black & White

Blades/Cord Installed:FC-Lead Wire 200:200mm, 2\* 18 AWG 1 conductor, UL 1015, solid, Black & White



|  |  |       |
|--|--|-------|
| GloTek, Inc.<br>www.globtek.com<br>186 Veterans Drive,<br>Northvale, NJ 07647<br>Tel. (201) 784-1000<br>Fax (201) 784-0111 | Drawing Title: GTM93021-2024-P2, ICT / ITE / Medical Power Supply/Class 2/Household Power Supply, Efficiency Level: V, Case Color/Style: GlobTek Black, Potted/Encapsulated in plastic housing, Regulated Switchmode AC-DC Power Supply AC Adaptor, Input Rating: 100-240V~, 50-60 Hz, Lead Wires , Output Rating: 20W, 24.0V@0.833A, Output Configuration: 200mm +15/-0 mm, 20/1C + Shield Cond, UL 1185, Waterproof IP68 Molded Female Plug, 2 sockets, 3.0mm Pitch, Equivalent to KCC sk2/2, Ferrite: None, GlobTek Black, GT Cord # C0223, Pin Out: Pin 1 Positive (+V), Pin 2 Common, Blades/Input Cord: 200mm, 2* 18 AWG 1 conductor, UL 1015, solid, Black & White, Approvals: UKCA; CB EN/IEC 60335-1; Ukraine; GOST-R; Double Insulation; WEEE; CE; RoHS; Fuse 60335; NEMKO EN/IEC 60335-1; cETLus UL1310; PSE; VCCI; China RoHS; cETLus UL1310; 61558-1; IEC 61558-1; CB 61558-2-16; IP68; UL 1310; UL 1310; Fuse 60335; |       |
|  | Model No. GTM93021-2024-P2   |       |
|  | Part No./Ordering No. PR9QI833KC2CHM(RVB)  | Rev B |

**OUTPUT CORD AND CONNECTOR:**

**KCF2/C0223**

ACTUAL CONNECTORS, OVERMOLDS, FERRITES MAY VARY SLIGHTLY FROM THE PICTURE BELOW

|                                      |   |
|--------------------------------------|---|
| CABLE TYPE                           | UL 1185   |
| CABLE LENGTH (mm)                    | 200mm +15/-0  |
| CABLE TOLERANCE (mm)                 | +15-0 mm  |
| WIRE GAUGE (AWG)                     | 20  |
| CONDUCTORS                           | 1C + Shield   |
| HANK DIMENSION (mm)                  | n/a   |
| CABLE / CONNECTOR OVERMOLD COLOR     | GlobTek Black   |
| FERRITE TYPE AND DIMENSION           | None  |
| FERRITE NUMBER OF TURNS(Definition)  | N/A   |
| FERRITE DIMENSION FROM STRAIN RELIEF | N/A   |
| FERRITE DIMENSION FROM PLUG          | N/A   |
| PLUG TYPE                            | Waterproof IP68 Molded Female Plug, 2 sockets, 3.0mm Pitch, Equivalent to KCC sk2/2 |
| OVERMOLDED                           | Yes   |
| OVER MOLD ORIENTATION                | Straight  |
| CONNECTOR PIN OUT                    | Pin 1 Positive (+V), Pin 2 Common   |

ADDITIONAL REQUIREMENTS

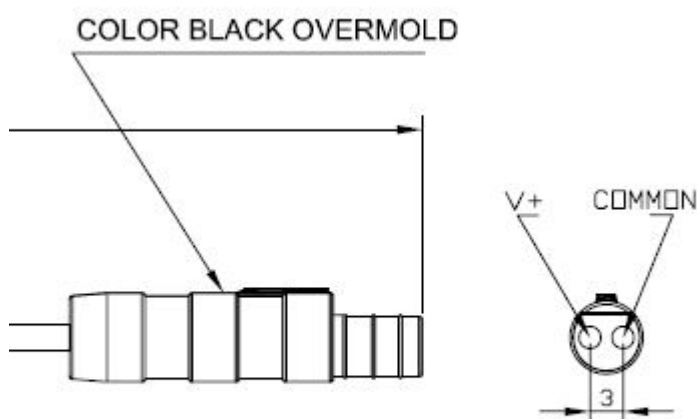

ADDITIONAL OUTPUT PLUG OPTIONS ARE AVAILABLE AT <https://www.globtek.com/connectors/>  
STANDARD PLUGS AND CONNECTORS CAN BE SEEN ONLINE AT <https://www.globtek.com/connectors/>  
CALCULATE VOLTAGE REGULATION/DROP WITH OUR ONLINE CALCULATOR: <https://en.globtek.com/output-cable-regulation-calculator/>

|  |   |
|--|---|
| <p>GlobTek, Inc.<br/> www.globtek.com<br/> 186 Veterans Drive,<br/> Northvale, NJ 07647<br/> Tel. (201) 784-1000<br/> Fax (201) 784-0111</p> | <p>Drawing Title: GTM93021-2024-P2, ICT / ITE / Medical Power Supply/Class 2/Household Power Supply, Efficiency Level: V, Case Color/Style: GlobTek Black, Potted/Encapsulated in plastic housing, Regulated Switchmode AC-DC Power Supply AC Adaptor, Input Rating: 100-240V~, 50-60 Hz, Lead Wires , Output Rating: 20W, 24.0V@0.833A, Output Configuration: 200mm +15/-0 mm, 20/1C + Shield Cond, UL 1185, Waterproof IP68 Molded Female Plug, 2 sockets, 3.0mm Pitch, Equivalent to KCC sk2/2, Ferrite: None, GlobTek Black, GT Cord # C0223, Pin Out: Pin 1 Positive (+V), Pin 2 Common, Blades/Input Cord: 200mm, 2* 18 AWG 1 conductor, UL 1015, solid, Black &amp; White, Approvals: UKCA; CB EN/IEC 60335-1; Ukraine; GOST-R; Double Insulation; WEEE; CE; RoHS; Fuse 60335; NEMKO EN/IEC 60335-1; cETLus UL1310; PSE; VCCI; China RoHS; cETLus UL1310; 61558-1; IEC 61558-1; CB 61558-2-16; IP68; UL 1310; UL 1310; Fuse 60335;</p> |
|  | <p>Model No. GTM93021-2024-P2</p>   |
|  | <p>Part No./Ordering No. PR9QI833KC2CHM(RVB) <span style="float: right;">Rev B</span></p>   |

**OUTPUT CONNECTOR HOOK UP**

TO ADDRESS SYSTEM-LEVEL EMI CONCERNS, FERRITE CHOKES/BEADS MAY BE ADDED/REVISED UPON REQUEST. A SAMPLE KIT OF GLOBTEK'S STANDARD FERRITES IS AVAILABLE UNDER GLOBTEK P/N: EMI-MITIGATION-KIT1

FOR ADDITIONAL INFORMATION, PLEASE READ OUR WHITE PAPER AT:

<https://en.globtek.com/technical-articles/ferrite-kit-radiated-emi-suppression-kit-for-globtek-power-supplies-cable-assemblies>

|  |  |       |
|--|--|-------|
| GloTek, Inc.<br>www.globtek.com<br>186 Veterans Drive,<br>Northvale, NJ 07647<br>Tel. (201) 784-1000<br>Fax (201) 784-0111 | Drawing Title: GTM93021-2024-P2, ICT / ITE / Medical Power Supply/Class 2/Household Power Supply, Efficiency Level: V, Case Color/Style: GlobTek Black, Potted/Encapsulated in plastic housing, Regulated Switchmode AC-DC Power Supply AC Adaptor, Input Rating: 100-240V~, 50-60 Hz, Lead Wires , Output Rating: 20W, 24.0V@0.833A, Output Configuration: 200mm +15/-0 mm, 20/1C + Shield Cond, UL 1185, Waterproof IP68 Molded Female Plug, 2 sockets, 3.0mm Pitch, Equivalent to KCC sk2/2, Ferrite: None, GlobTek Black, GT Cord # C0223, Pin Out: Pin 1 Positive (+V), Pin 2 Common, Blades/Input Cord: 200mm, 2* 18 AWG 1 conductor, UL 1015, solid, Black & White, Approvals: UKCA; CB EN/IEC 60335-1; Ukraine; GOST-R; Double Insulation; WEEE; CE; RoHS; Fuse 60335; NEMKO EN/IEC 60335-1; cETLus UL1310; PSE; VCCI; China RoHS; cETLus UL1310; 61558-1; IEC 61558-1; CB 61558-2-16; IP68; UL 1310; UL 1310; Fuse 60335; |       |
|  | Model No. GTM93021-2024-P2   |       |
|  | Part No./Ordering No. PR9QI833KC2CHM(RVB)  | Rev B |

LABEL:L-1186

|                                |  |
|--------------------------------|--|
| LABEL P/N                      | Standard GT  |
| MATERIAL                       | Flat Thermal Transfer, Imprintable, Polyester Label and/or Pad Printed and/or Molded, and/or Laser Engraved in the case                    |
| BACKGROUND COLOR               | Black if housing is Black, White or Silver if housing is White or Gray.  |
| TEXT COLOR                     | White or Silver if label is Black Background for Black housing. Black if label is White or Silver background and Housing is White or Gray. |
| LABEL WIDTH (mm)               | 39.5   |
| LABEL HEIGHT (mm)              | 36.5   |
| SPECIAL BARCODE LABEL MATERIAL | No   |

Below is the minimum information which will appear on the label. NOTE: in the logo area additional/actual positioning of symbols and text is subjected to change as per agency updates/requirements or additional model approvals become available.  
Regulatory certifications/label markings may be in logo area on the label or molded into the case housing outside the label area.  
Information will be shown via label and/or pad printed and/or molded and/or laser engraved in the case. \* Date code markings at GlobTek option

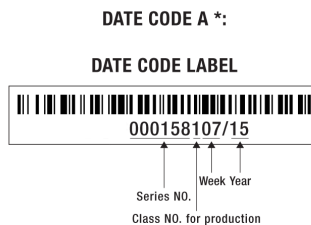

or  
**DATE CODE B \*:**  
**WWYY**  
**WW = WEEK**  
**YY = YEAR**

A=ICT / ITE / Medical Power Supply/Class 2/Household Power Supply  
B=P/N: (料号) PR9QI833KC2CHM(RVB)  
C=Model (型号) GTM93021-2024-P2  
D=Input (输入)100-240V~, 50-60 Hz, 0.6A Max  
E=Output (输出)24.0 V 0.833 A, 20.00W

|  |  |       |
|--|--|-------|
| GloTek, Inc.<br>www.globtek.com<br>186 Veterans Drive,<br>Northvale, NJ 07647<br>Tel. (201) 784-1000<br>Fax (201) 784-0111 | Drawing Title: GTM93021-2024-P2, ICT / ITE / Medical Power Supply/Class 2/Household Power Supply, Efficiency Level: V, Case Color/Style: GlobTek Black, Potted/Encapsulated in plastic housing, Regulated Switchmode AC-DC Power Supply AC Adaptor, Input Rating: 100-240V~, 50-60 Hz, Lead Wires , Output Rating: 20W, 24.0V@0.833A, Output Configuration: 200mm +15/-0 mm, 20/1C + Shield Cond, UL 1185, Waterproof IP68 Molded Female Plug, 2 sockets, 3.0mm Pitch, Equivalent to KCC sk2/2, Ferrite: None, GlobTek Black, GT Cord # C0223, Pin Out: Pin 1 Positive (+V), Pin 2 Common, Blades/Input Cord: 200mm, 2* 18 AWG 1 conductor, UL 1015, solid, Black & White, Approvals: UKCA; CB EN/IEC 60335-1; Ukraine; GOST-R; Double Insulation; WEEE; CE; RoHS; Fuse 60335; NEMKO EN/IEC 60335-1; cETLus UL1310; PSE; VCCI; China RoHS; cETLus UL1310; 61558-1; IEC 61558-1; CB 61558-2-16; IP68; UL 1310; UL 1310; Fuse 60335; |       |
|  | Model No. GTM93021-2024-P2   |       |
|  | Part No./Ordering No. PR9QI833KC2CHM(RVB)  | Rev B |

|   |   |
|---|---|
| AGENCY ONLINE DOCUMENTS                         | <a href="http://globtek.info/certs/GTM93021">http://globtek.info/certs/GTM93021</a>   |
| CE EC-Declaration for Medical                   | <a href="#">Contact GlobTek for more information</a>  |
| CE EC-Declaration for Industrial/Commercial/ITE | <a href="http://globtek.force.com/models/ec_declaration_product?id=01ta0000003fMxV&amp;i=4">http://globtek.force.com/models/ec_declaration_product?id=01ta0000003fMxV&amp;i=4</a>         |
| CE EC-Declaration for Household                 | <a href="http://globtek.force.com/models/ec_declaration_product?id=01ta0000003fMxV&amp;h=3">http://globtek.force.com/models/ec_declaration_product?id=01ta0000003fMxV&amp;h=3</a>         |
| UKCA-Declaration for Medical                    | <a href="#">Contact GlobTek for more information</a>  |
| UKCA-Declaration for Industrial/Commercial/ITE  | <a href="http://globtek.force.com/models/ukca_declaration_product?id=01ta0000003fMxV&amp;i=4">http://globtek.force.com/models/ukca_declaration_product?id=01ta0000003fMxV&amp;i=4</a>     |
| UKCA-Declaration for Household                  | <a href="http://globtek.force.com/models/ukca_declaration_product?id=01ta0000003fMxV&amp;h=3">http://globtek.force.com/models/ukca_declaration_product?id=01ta0000003fMxV&amp;h=3</a>     |
| Morocco SDoC Declaration                        | <a href="https://globtek.secure.force.com/models/Morocco_SDoC_Declaration?id=a0Oa000000C2j1EAJ">https://globtek.secure.force.com/models/Morocco_SDoC_Declaration?id=a0Oa000000C2j1EAJ</a> |
| RoHS/RoHS3 Declaration                          | <a href="https://www.globtek.com/pdf/rohs_cert/01ta0000003fMxVAAU">https://www.globtek.com/pdf/rohs_cert/01ta0000003fMxVAAU</a>   |
| REACH Declaration                               | <a href="https://www.globtek.com/pdf/iso_certificates/REACH.pdf">https://www.globtek.com/pdf/iso_certificates/REACH.pdf</a>   |
| Conflict Minerals Declaration                   | <a href="https://www.globtek.com/pdf/conflict-minerals.pdf">https://www.globtek.com/pdf/conflict-minerals.pdf</a>   |
| Prop 65 Statement                               | <a href="https://en.globtek.com/prop-65-statement.pdf">https://en.globtek.com/prop-65-statement.pdf</a>   |

IPXY rating is based on 3rd party testing and customers should check suitability and test system level IPXY rating before ordering.

## Regulatory Certifications/Label Markings

Below follows a link to the latest regulatory certifications and marks for this specific product. National standards as well as certification schemes are constantly changing and so is the set of certification marks and symbols applicable to this product. Various standards, marks and symbols, and certificates are subject to change at any time without notice.

Additional standards or unique country certifications are available upon request. Please contact Globtek to request a quotation.

LATEST PRODUCT/MODEL CERTIFICATIONS: <https://www.globtek.com/datasheet/w70773>

AGENCY ONLINE DOCUMENTS <http://globtek.info/certs/GTM93021>

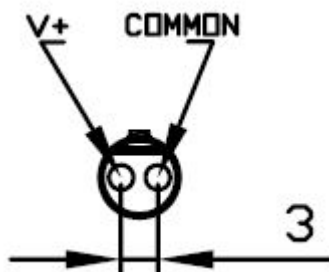

Pin 1 Positive (+V), Pin 2 Common

|   |  |       |
|---|--|-------|
| GlobTek, Inc.<br>www.globtek.com<br>186 Veterans Drive,<br>Northvale, NJ 07647<br>Tel. (201) 784-1000<br>Fax (201) 784-0111 | Drawing Title: GTM93021-2024-P2, ICT / ITE / Medical Power Supply/Class 2/Household Power Supply, Efficiency Level: V, Case Color/Style: GlobTek Black, Potted/Encapsulated in plastic housing, Regulated Switchmode AC-DC Power Supply AC Adaptor, Input Rating: 100-240V~, 50-60 Hz, Lead Wires , Output Rating: 20W, 24.0V@0.833A, Output Configuration: 200mm +15/-0 mm, 20/1C + Shield Cond, UL 1185, Waterproof IP68 Molded Female Plug, 2 sockets, 3.0mm Pitch, Equivalent to KCC sk2/2, Ferrite: None, GlobTek Black, GT Cord # C0223, Pin Out: Pin 1 Positive (+V), Pin 2 Common, Blades/Input Cord: 200mm, 2* 18 AWG 1 conductor, UL 1015, solid, Black & White, Approvals: UKCA; CB EN/IEC 60335-1; Ukraine; GOST-R; Double Insulation; WEEE; CE; RoHS; Fuse 60335; NEMKO EN/IEC 60335-1; cETLus UL1310; PSE; VCCI; China RoHS; cETLus UL1310; 61558-1; IEC 61558-1; CB 61558-2-16; IP68; UL 1310; UL 1310; Fuse 60335; |       |
|   | Model No. GTM93021-2024-P2   |       |
|   | Part No./Ordering No. PR9QI833KC2CHM(RVB)  | Rev B |

## PACKAGING

|                                  |   |
|----------------------------------|---|
| Packing Spec P/N:                | Standard Potted, Individually Box.gif   |
| Box Qty                          | 147   |
| Gift Box Size (mm):              | 55 x 51 x 52  |
| Gift Box Color:                  | White   |
| Master Carton Size (mm):         | 410 x 380 x 195   |
| Master Carton Cubic Volume (m³): | 0.03  |
| Master GW (Kg):                  | 15.6 kg   |
| BLADES INCLUDED:                 | FC-Lead Wire 200: 200mm, 2* 18 AWG 1 conductor, UL 1015, solid, Black & White |
| BLADE/CORD INSTALLED:            | FC-Lead Wire 200: 200mm, 2* 18 AWG 1 conductor, UL 1015, solid, Black & White |
| USER MANUAL*:                    |   |
| USER MANUAL WEB LINK:            |   |

\* This specification sheet is considered the user manual for all applications. It is expected that the buyer of this product will use it to formulate their own user manual for their end product and a user manual specifically for the power adapter is not usually required. If a user manual is not specifically listed above then none will be provided with this unit.

If specific packaging is required, this section must specify all requirements and note "no exceptions". If this section does not specify packaging, it is subject to change without notice at GlobTek's discretion

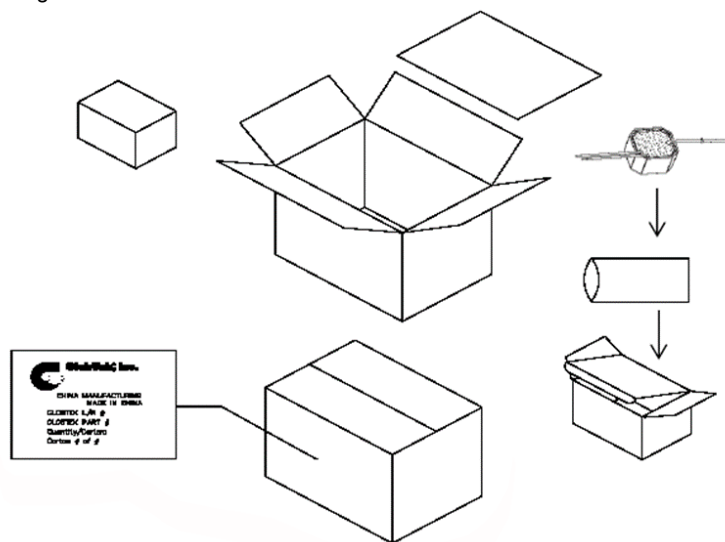

### PROPRIETARY INFORMATION

PROPRIETARY OF GLOBTEK, INC. ANY REPRODUCTION, DISCLOSURE OR USE OF THIS DRAWING, IN WHOLE OR IN PART, IS HEREBY PROHIBITED EXCEPT AS SPECIFIED IN Page 13 of 15

WRITING BY GLOBTEK, INC. © GlobTek, Inc. 2013 - 2023

quest / 05/09/2023 3:57:12 AM GMT

|  |   |
|--|---|
| <p>GlobTek, Inc.<br/> www.globtek.com<br/> 186 Veterans Drive,<br/> Northvale, NJ 07647<br/> Tel. (201) 784-1000<br/> Fax (201) 784-0111</p> | <p>Drawing Title: GTM93021-2024-P2, ICT / ITE / Medical Power Supply/Class 2/Household Power Supply, Efficiency Level: V, Case Color/Style: GlobTek Black, Potted/Encapsulated in plastic housing, Regulated Switchmode AC-DC Power Supply AC Adaptor, Input Rating: 100-240V~, 50-60 Hz, Lead Wires , Output Rating: 20W, 24.0V@0.833A, Output Configuration: 200mm +15/-0 mm, 20/1C + Shield Cond, UL 1185, Waterproof IP68 Molded Female Plug, 2 sockets, 3.0mm Pitch, Equivalent to KCC sk2/2, Ferrite: None, GlobTek Black, GT Cord # C0223, Pin Out: Pin 1 Positive (+V), Pin 2 Common, Blades/Input Cord: 200mm, 2* 18 AWG 1 conductor, UL 1015, solid, Black &amp; White, Approvals: UKCA; CB EN/IEC 60335-1; Ukraine; GOST-R; Double Insulation; WEEE; CE; RoHS; Fuse 60335; NEMKO EN/IEC 60335-1; cETLus UL1310; PSE; VCCI; China RoHS; cETLus UL1310; 61558-1; IEC 61558-1; CB 61558-2-16; IP68; UL 1310; UL 1310; Fuse 60335;</p> |
|  | <p>Model No. GTM93021-2024-P2</p>   |
|  | <p>Part No./Ordering No. PR9QI833KC2CHM(RVB) <span style="float: right;">Rev B</span></p>   |

### INSTRUCTIONS TO THE OEM SYSTEMS ENGINEER

It is the responsibility of the OEM systems engineer to provide the end system user instructions and warnings for the use of this product in the end system.

If an input cord is required for this product, AC Mains voltage should be provided to the power supply by a power supply cord approved to the national standards of the country in which it will be used.

This product is not designed to be repaired. No serviceable parts inside. A blown internal fuse is an indication of catastrophic failure of circuit component(s). If a Failure Analysis is required for a failed power supply/battery charger, please return the damaged unit to GlobTek for an accurate determination of the root cause of the failure.

EMC Compliance of the complete OEM product, including the GlobTek power supply/battery charger needs to be verified by the OEM systems engineer.

### INSTRUCTION SHEET

N/A

|   |   |              |
|---|---|--------------|
| <p>GlobTek, Inc.<br/>www.globtek.com<br/>186 Veterans Drive,<br/>Northvale, NJ 07647<br/>Tel. (201) 784-1000<br/>Fax (201) 784-0111</p> | <p>Drawing Title: GTM93021-2024-P2, ICT / ITE / Medical Power Supply/Class 2/Household Power Supply, Efficiency Level: V, Case Color/Style: GlobTek Black, Potted/Encapsulated in plastic housing, Regulated Switchmode AC-DC Power Supply AC Adaptor, Input Rating: 100-240V~, 50-60 Hz, Lead Wires , Output Rating: 20W, 24.0V@0.833A, Output Configuration: 200mm +15/-0 mm, 20/1C + Shield Cond, UL 1185, Waterproof IP68 Molded Female Plug, 2 sockets, 3.0mm Pitch, Equivalent to KCC sk2/2, Ferrite: None, GlobTek Black, GT Cord # C0223, Pin Out: Pin 1 Positive (+V), Pin 2 Common, Blades/Input Cord: 200mm, 2* 18 AWG 1 conductor, UL 1015, solid, Black &amp; White, Approvals: UKCA; CB EN/IEC 60335-1; Ukraine; GOST-R; Double Insulation; WEEE; CE; RoHS; Fuse 60335; NEMKO EN/IEC 60335-1; cETLus UL1310; PSE; VCCI; China RoHS; cETLus UL1310; 61558-1; IEC 61558-1; CB 61558-2-16; IP68; UL 1310; UL 1310; Fuse 60335;</p> |              |
|   | <p>Model No. GTM93021-2024-P2</p>   |              |
|   | <p>Part No./Ordering No. PR9QI833KC2CHM(RVB</p>   | <p>Rev B</p> |

