



Controller For Precision Converter Evaluation/Demonstration Boards

Evaluation Board Controller

FEATURES

Full-Featured DSP based Controller for Analog Devices
Evaluation/Demonstration Boards

Compatible with 3V and 5V Systems

On-Board ADSP-2189M Digital Signal Processor

High Speed Data Transfer Rates

6Msps Evaluation Board to DSP

32Kbytes/sec Controller to PC

Compatible with Parallel and Serial Interface
Evaluation Boards

112Kwords Data Ram

(64Kwords External

48Kwords Internal)

Fully Controllable/Programmable Power Supplies

GENERAL DESCRIPTION

The Evaluation Board Controller is the main component in a complete self-contained evaluation and demonstration system for Analog Devices Precision Converters. The block diagram shown below indicates the major blocks of the Evaluation Board Controller. It is a complete unit allowing the PC to communicate with a range of evaluation boards supplied by Analog Devices via a high-speed parallel data link. Software is provided to allow the user to send commands to the evaluation board and read data samples or on-board registers for the device being evaluated. The Evaluation Board Controller connects to the evaluation board via a 96 way edge connector. The pinout of the connector is a standard format which is consistent between evaluation boards.

FUNCTIONAL BLOCK DIAGRAM

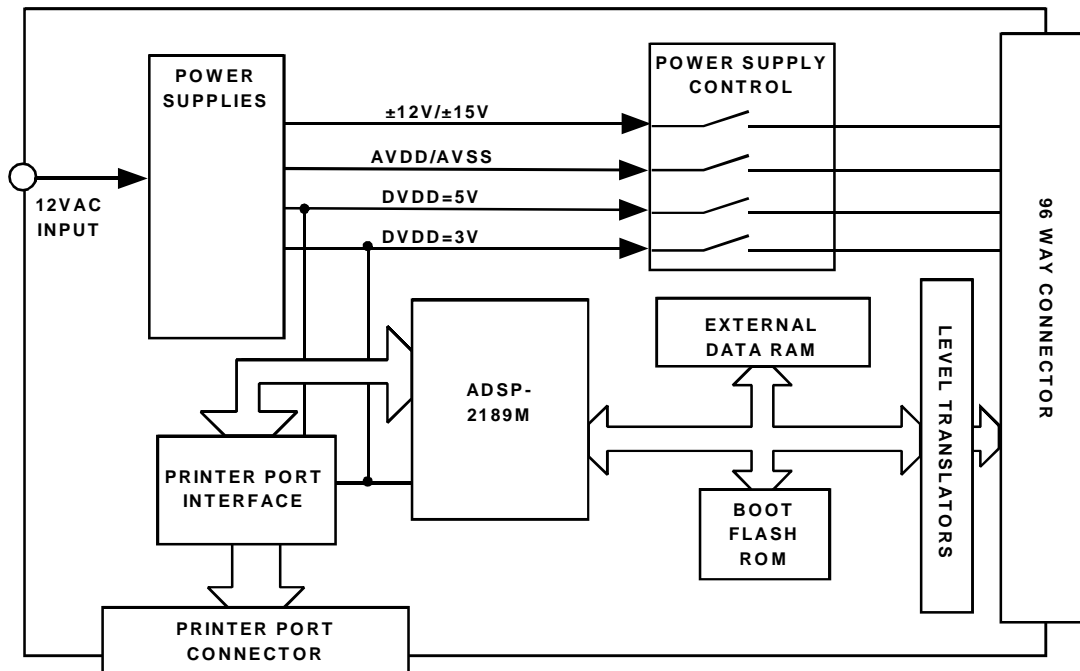

REV. A

Information furnished by Analog Devices is believed to be accurate and reliable. However, no responsibility is assumed by Analog Devices for its use, nor for any infringements of patents or other rights of third parties which may result from its use. No license is granted by implication or otherwise under any patent or patent rights of Analog Devices.

Evaluation Board Controller

The Evaluation Board Controller and other components can be ordered from Analog Devices with the following order numbers.

Order No.	Description
Eval-Control Brd2	Evaluation Board Controller
Eval-110VAC-US	110VAC Transformer (US pinout)
Eval-220VAC-EU	220VAC Transformer (European pinout)
Eval-220VAC-UK	220VAC Tranformer (UK pinout)

The system allows speedy demonstration and evaluation of Analog Devices Precision Converter Products, allowing the user to directly test the device in question and to shorten the time required to develop their own software and hence speed up their design process.

SYSTEM REQUIREMENTS

A Pentium 90 or greater PC with ¹Bidirectional Printer Port

Evaluation Board Controller

A standard 12VAC, 1A mains transformer

An Evaluation Board (with software) for the device under consideration.

A Standard Centronics Printer Cable

¹The type of printer port available on the PC in question can be determined by examining the BIOS. Exactly how this is done is dependant on the make/model of PC. The user should refer to the computers user manual for further information. Acceptable printer ports can be described as Bidirectional, PS/2, ECP or EPP.

EVALUATION BOARD CONTROLLER TECHNICAL SPECIFICATIONS¹

40MIPs Processing Speed

112Kwords Data RAM

(48Kwords Internal Data Ram,
64Kwords External Data Ram)

3V/5V Logic Level Translators

Fast Parallel PC Link

Fully Controllable Power Supply Unit

Digital Supply: 3V/5V/On/Off

Analog Supplies: 3V/5V/On/Off

Additional Supplies: $\pm 12V/\pm 15V$ /On/Off

EZ-ICE Compatible

¹Analog Devices reserves the right to change any of the specifications without prior notice.

HARDWARE DESCRIPTION

The Evaluation Board Controller is based around an ADSP-2189M Digital Signal Processor (DSP). The DSP runs from a 20MHz crystal and an on-chip clock doubler gives an instruction speed of 40MIPs. The DSP features 32Kwords of Internal Program Ram and 48Kwords of internal Data RAM. The Data RAM is supplemented with

64Kwords of external data RAM. The DSP also provides two Serial Ports (SPORTs) which have a maximum output serial clock rate of 20MHz. Both SPORTs are available on the 96way edge connector as is a section of the parallel Data and Address bus.

To facilitate operation of both 3V and 5V evaluation boards all logic signal are equipped with level translators. For 3V devices no level translation is required (since the DSP operates from 3V) so the level translators act as closed switches. For 5V devices all logic 1 signals coming from the DSP are level translated to 5V. 5V logic signals coming from the device under test are translated to 3V by the translators before reaching the DSP.

Communications

The Evaluation Board Controller allows a user to gather a large number of samples from an evaluation board and upload them to a PC for analysis. The Evaluation Board Controller uses a high-speed interface based around the PC's Printer Port. As the port is used both for sending and receiving data it must have bidirectional capability. Most PCs (particularly the Pentium class) have this facility as standard but it is possible to check in the PC's BIOS. How the BIOS is viewed depends on the make of PC being used but typical methods are pressing CTRL, ALT and ENTER during power up. The user should consult the operating manual of their PC for further details. Suitable printer port types may be described as Bidirectional, PS/2, EPP or ECP.

Power Supplies

The Evaluation Board Controller has its own on-board power supplies which are derived from a 12VAC power supply with a 1A current capability. These supplies are used to supply the current for the Evaluation Board Controller itself as well as that required for the evaluation board and are available from Analog Devices using the order numbers given above. The power supplies which go to the evaluation board via the edge connector are fully controllable by the software supplied. The Evaluation Board Controller can provide $\pm 3V$ or $\pm 5V$ analog supplies as well as a +3V or +5V digital supply. There is also a $\pm 12V / \pm 15V$ supply for powering op-amps etc. The value of the supplies are selected by jumpers LK1 and LK2. Table I below lists the power supplies available while Table II shows the jumper setting for the $\pm 12V / \pm 15V$ supplies.

TABLE I. Evaluation Board Controller POWER SUPPLIES

Power Supply	Voltages	ON/OFF Capability
AVDD	+3V/+5V ¹	Yes
AVSS	-3V/-5V ¹	Yes
DVDD	+3V/5V ¹	Yes
Additional	+12V/+15V ² -12V/-15V ²	Yes Yes

1. The voltage these supplies produce is programmed under software control.

2. The $\pm 12V/\pm 15V$ supplies are set by a hardware link on the Evaluation Board Controller. The supplies should be set for $\pm 12V$ operation by default unless the specific evaluation board requires that they be set for $\pm 15V$ operation.

Evaluation Board Controller

Table II Power Supply Jumper Settings

Jumper Position	Supply
LK1 - IN	+12V
LK1 - OUT	+15V
LK2 - IN	-12V
LK2 - OUT	-15V

Output Connector

The 96 way edge connector provides connection to all the available power supplies, serial ports and data/address buses required to operate the range of Analog Devices evaluation boards which are compatible with this system. The pinout of the 96 way connector is shown in Table III below.

SETUP PROCEDURE

Hardware

The Evaluation Board Controller is part of a self-contained system which allows a user to quickly and easily evaluate/demonstrate the functions and performance of a particular Analog Devices Precision Converter. All evaluation boards which are compatible with the Evaluation Board Controller have the designation CB in their order code. For example the order code for an evaluation board based around the AD7476 would be EVAL-AD7476CB.

The evaluation board plugs directly into the 96 way connector on the Evaluation Board Controller. The Evaluation Board Controller is powered from a standard 12VAC power supply. The power supply is available from Analog Devices as an accessory. The power supplies are also available for other suppliers such as Digkey (US) and Campbel Collins (UK).

A Centronics printer port cable is supplied with the Evaluation Board Controller kit enabling communication between the Evaluation Board Controller and the PC.

Software

The Evaluation Board Controller come supplied with a CD which contains software for previously released evaluation boards. Therefore if the user has an evaluation board which was compatible with the previous version of the Controller (Eval Control Board) they will be able to use the Evaluation Board Controller as well.

When the user purchases an new evaluation board kit it will contain all the software necessary to operate that particular evaluation board. The most up-to-date evaluation software is always available on the Analog Devices web site (www.analog.com). The documentation which is supplied with the evaluation board also contains information about installing the software as well as a detailed description of the evaluation board and a data sheet for the device in question.

All software supplied for the Evaluation Board Controller and evaluation boards comes on a CD ROM. When the CD is inserted into the PC an installation program will automatically begin. This program will install the evaluation software onto the users machine and will also install the Technical Note for the evaluation board as well as the Data Sheet for the device in questions. All literature on

the CD is in Adobe's Portable Document Format (PDF) and will require Acrobat Reader™ to be viewed or printed.

For the purposes of explanation the following text and figures refer to the software of a typical evaluation board.

TABLE III. 96 WAY CONNECTOR PINOUT

	ROW A	ROW B	ROW C
1	DT1	FL1	DR1
2	TFS1	D0	RFS1
3	SCLK1	D1	SCLK1
4	DGND	DGND	DGND
5	DT0	D2	DR0
6	TFS0	D3	RFS0
7	SCLK0	D4	SCLK0
8	DVDD	DVDD	DVDD
9	/RD	D5	/WR
10	A7	D6	/CS
11	A5	D7	A6
12	DGND	DGND	DGND
13	A3	D8	A4
14	A1	D9	A2
15	N/C	D10	A0
16	DGND	DGND	DGND
17	FL0	D11	/IRQ2
18	D12	D13	D14
19	CLKOUT	I/O1	D15
20	DGND	DGND	DGND
21	AGND	AGND	AGND
22	AGND	AGND	AGND
23	AGND	AGND	AGND
24	AGND	AGND	AGND
25	AGND	AGND	AGND
26	AGND	AGND	AGND
27	I/O2	AGND	I/O3
28	N/C	AGND	N/C
29	AGND	AGND	AGND
30	-12V/-15V	AGND	+12V/+15V
31	AVSS	AVSS	AVSS
32	AVDD	AVDD	AVDD

Evaluation Board Controller

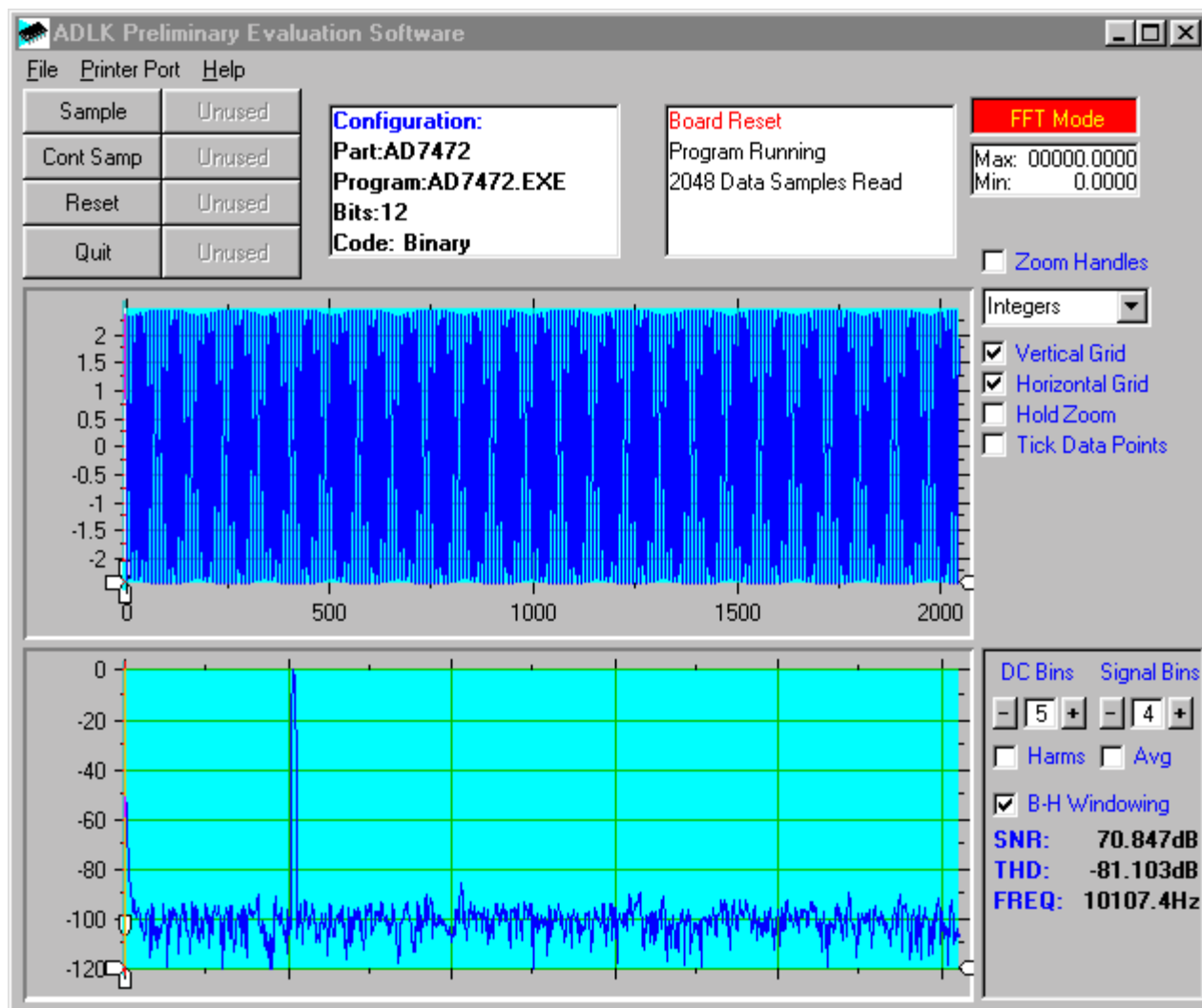

Figure 1. Evaluation Board Controller Main Screen

SOFTWARE DESCRIPTION

The software which controls the Evaluation Board Controller and hence the evaluation board has three main screens. The screen shown in Figure 1 shows the screen which appears when the software is run. The main function of this screen is to allow the user to read a predetermined number of samples from the evaluation board and display them in both the time and frequency domain. The screen can be divided into 3 sections. The upper third of the screen contains the control buttons, the menu bar and various status windows. The control buttons allow the user to enter the setup menu, take samples and get information about the software. The menu bar allows the user to select which printer port is to be used to control the Evaluation Board Controller, load and save data etc. The status windows indicate the setup of the evaluation board/device, number of samples taken and any information/error messages that are generated.

The middle third of the screen is a Digital Storage Oscilloscope (DSO). When samples are uploaded from the Evaluation Board Controller they are displayed here. The samples can be displayed either as integer values or as voltages (determined by the input range of the device in

question). Once samples have been displayed clicking at any point in the graph will display the sample number and value of the point directly beneath the cursor. Along the axis of the graph are the "zoom handles". These allow the user to zoom in and out to get a closer look at a particular sample if required. When another set of samples is taken the graph will attempt to display all values collected unless the **Hold Zoom** check box is ticked. In this case the graph will keep the same axis settings as for the previous set of data samples. Additional check boxes are provided to give the user control over the vertical and horizontal grids and data points.

The lower third of the screen will show either a Fast Fourier Transform (FFT) of the data or a Histogram which shows the number of occurrences of each particular code read back. The FFT (the default option) is typically used when the user is concerned with examining an ADC's performance in the frequency domain while the Histogram will give an indication of the ADC's performance to DC signals. The option displayed can be toggled by clicking on the FFT Mode/Histogram Mode button in the top right of the screen. Figure 2 shows how the main screen looks when the Histogram Option is selected.

Evaluation Board Controller

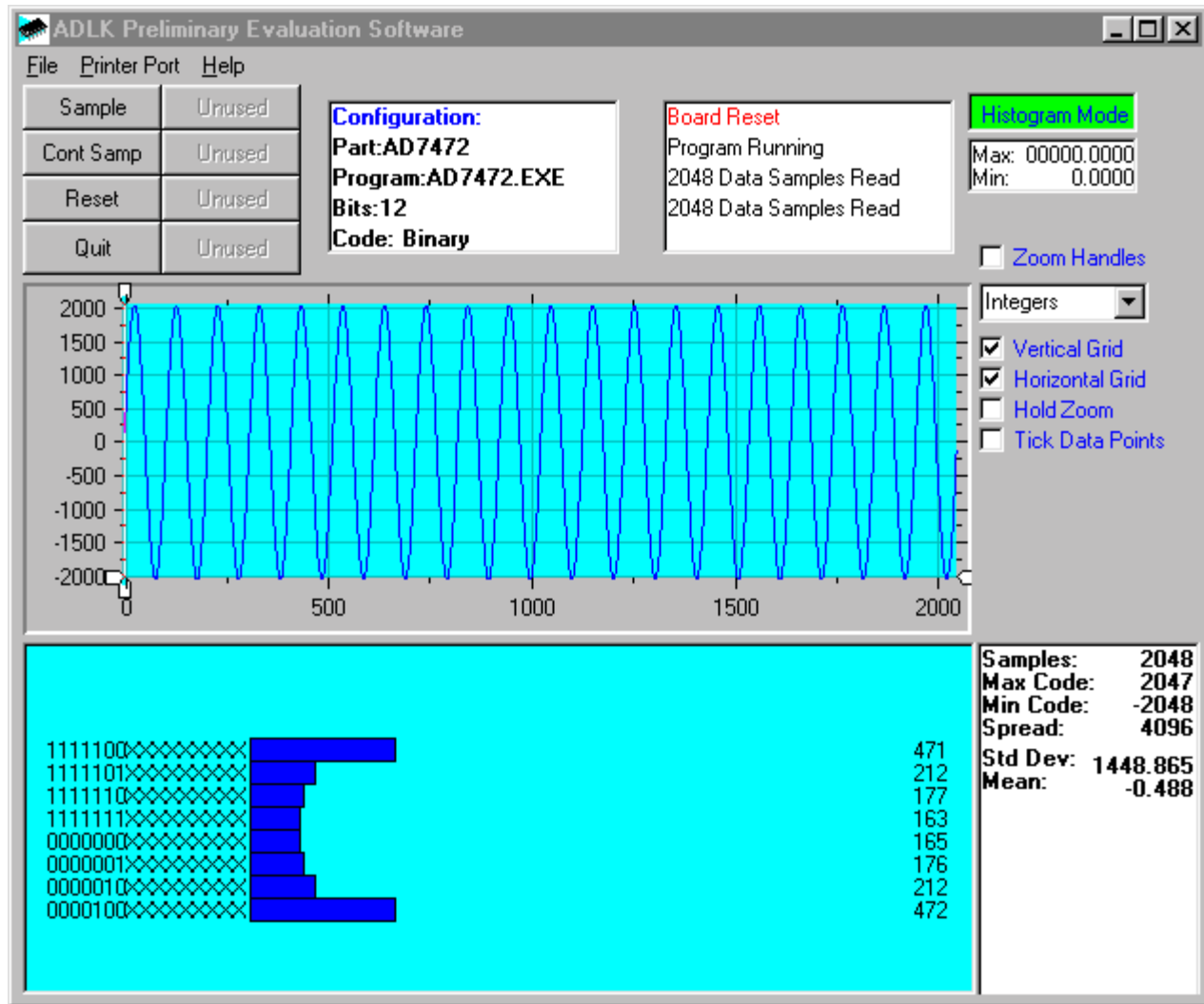

Figure 2. Evaluation Board Controller Main Screen - Histogram Mode

Setup Screen

The Setup Screen is responsible for allowing the user to load a configuration file for the evaluation board. The configuration file will give the software detailed information about the evaluation board and part connected to the Evaluation Board Controller such as number of bits, maximum sampling rate, power supply requirements etc. The configuration file also tells the software the name of the DSP program file which it should download to the Evaluation Board Controller. These files are supplied by Analog Devices with the evaluation board. Figure 3 shows the Setup Screen.

SETTING UP THE EVALUATION BOARD CONTROLLER

The following text describes how the evaluation board Evaluation Board Controller and software should be set up for the user to begin using the complete system. The

Evaluation Board Controller and evaluation board should be connected together (via the 96 way connector). The power should be applied to the Evaluation Board Controller. At this stage the red LED should be flashing which indicates that the Evaluation Board Controller is functional and ready to receive instructions. The software which should have been installed should be loaded before the printer port cable is connected between the Evaluation Board Controller and the PC. This will ensure that the printer port has been initialized properly. The printer port cable can then be connected between the PC and the Evaluation Board Controller.

Running the Software

With the hardware setup the user is now in a position to use the software to control the Evaluation Board Controller and evaluation board. In the software the user should select the **File** menu and click on **Setup**. This will display

Evaluation Board Controller

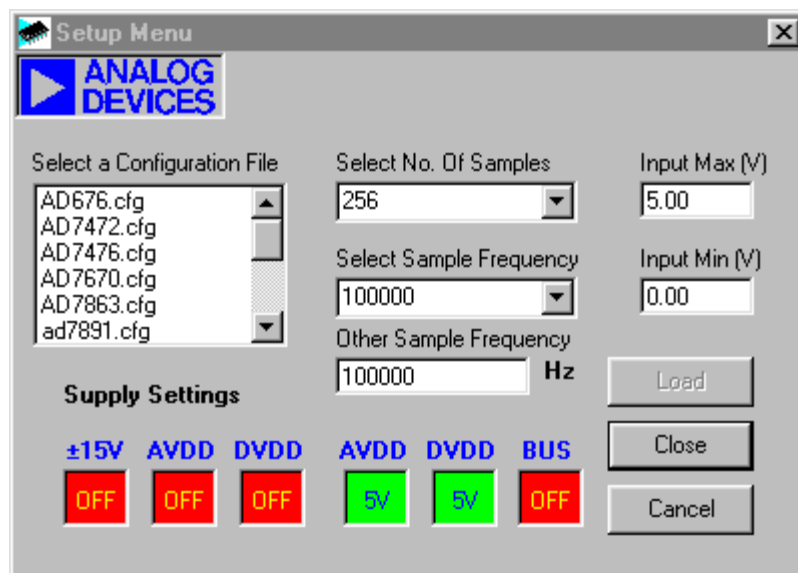

Figure 3. The Setup Screen

the setup form. A window on the left of the setup form list all the available configuration files. The configuration files are text based files which contain information about the particular evaluation board to be tested. The information will cover such things as the part name, number of samples to be taken, default and maximum sampling frequency power supply settings etc. The configuration file also contains the name of the DSP program file which is to be downloaded to the Evaluation Board Controller. The user should select the relevant configuration file and click **Load**. The Evaluation Board Controller will be reset and the DSP program will be downloaded. When the download has been completed the power supply settings indicated in the configuration file are set and the user may hear some of the relays clicking. The pull-down menus items such as number of samples and sampling frequency will have been set to the default values specified by the configuration file. The user is free to change these at will. Once all the settings had been decided the user can click **Close** to return to the main form.

Taking Samples

When the user clicks **Sample** the software will instruct the Evaluation Board Controller to take the required number of samples at the required frequency from the evaluation board. These samples are then uploaded and displayed. An FFT and Histogram are also calculated and displayed. If the user clicks **Cont Samp** the software will repeat the process indefinitely until the user clicks the button again. While the software is continuously sampling data the other control buttons are disabled.

Other Buttons

The **Reset** button will cause the Evaluation Board Controller to perform a reset function. When this happens the power supplies are turned off and the program in DSP memory is lost. The user should repeat the setup instructions to download another program if required.

The **Quit** button will exit the software, the program running on the Evaluation Board Controller is not terminated.

MENU BAR ITEMS

The main screen of the Evaluation Board Controller contains a number of options available as pull-down menu items. The functions of these are listed below.

File Menu:

Setup Menu: Selecting this option displays the Setup Screen as shown in Figure 3.

Load Raw Data: Selecting this option allows the user to load data which had been saved by the software during a previous session.

Save Raw Data: Selecting this option allows the user to save the current set of sample data points. The data can be reloaded to the Evaluation Board Controller software at a later date or can be used by other programs for further analysis

Save Binary Data: Selecting this option allows the user to save the current set of sample data points. The data is saved in binary format as a text file. This method can be useful for examining code flicker, looking for stuck bits etc.

Save FFT Data: Selecting this option allows the user to save the current set of FFT data points. FFT data cannot be reloaded into the Evaluation Board Controller software but can be loaded into other software packages for further analysis.

Exit: Quits the program.

Evaluation Board Controller

Printer Port:

This menu item allows the user to select which printer port should be used for communication with the Evaluation Board Controller.

LPT1: This option selects 0x378 as the printer port address. This is the default option.

LPT2: This option selects 0x278 as the printer port address.

PRN: This option selects 0x3BC as the printer port address.

Help:

This menu item gives information about the current revision of software for the particular evaluation board being used.

SOFTWARE CONFIGURATION FILES

Software Configuration Files give the Evaluation Board Controller software information on how the software and hardware should perform. They contain information such as the name of the DSP program to download, the default and maximum sample frequencies, the number of samples to take and the power supply settings to use. A typical Software Configuration File (*.cfg) is shown in Listing 1.

```
[EVAL-CONTROL BOARD]
partname:AD7894
programname:ad7894.PRG

samplefrequency:100000
maxsamplefrequency:1000000
samples:2048

+/-15V:on
dvdd:5:on
avdd:5:on
bus:on
;options 2scomp, binary
dataformat:2scomp
numberofbits:14
inputVmax:2.5
inputVmin:-2.5
[endofconfig]
```

Listing 1. Software Configuration File.

Evaluation Board Controller

Table IV. Troubleshooting guide

Symptom	Possible Cause
LED Not Flashing	No power is applied to the evaluation board. The evaluation board requires a 12V AC supply.
No Communication between PC and Evaluation Board.	<p>There are a number of possible causes for a communications failure. These are listed below.</p> <ol style="list-style-type: none">1. Cable not connected or incorrect cable type. The cable should be a fully-populated Centronics printer port cable.2. Incorrect printer port. The evaluation board requires that the printer port has bi-directional capability. Acceptable types are PS/2, EPP and ECP.3. Correct Printer Port but bidirectional capability not enabled. It is possible that a bidirectional printer port can be set to be unidirectional mode in the PC BIOS. The user should consult the PC manual for instructions on examining the BIOS.4. Incorrect Printer Port Address. There are three possible addresses for a printer ports and the one fitted to a users PC may not be the same as the default address. This can be changed using the Printer Port menu item.
Programs Timeout	The evaluation board being used with the Evaluation Board Controller may have the links incorrectly set.

REVISION RECORD		DATE:
LTR	ECD NO:	9/99
B	Faster Interface	KK
BT	Extra Memory	KK
C	Modify Reg 8 & 9	KK

REVISION RECORD		DATE:
LTR	ECD NO:	9/99
B	Faster Interface	KK
BT	Extra Memory	KK
C	Modify Reg 8 & 9	KK

REVISION RECORD		DATE:
LTR	ECD NO:	9/99
B	Faster Interface	KK
BT	Extra Memory	KK
C	Modify Reg 8 & 9	KK

REVISION RECORD		DATE:
LTR	ECD NO:	9/99
B	Faster Interface	KK
BT	Extra Memory	KK
C	Modify Reg 8 & 9	KK

REVISION RECORD		DATE:
LTR	ECD NO:	9/99
B	Faster Interface	KK
BT	Extra Memory	KK
C	Modify Reg 8 & 9	KK

REVISION RECORD		DATE:
LTR	ECD NO:	9/99
B	Faster Interface	KK
BT	Extra Memory	KK
C	Modify Reg 8 & 9	KK

REVISION RECORD		DATE:
LTR	ECD NO:	9/99
B	Faster Interface	KK
BT	Extra Memory	KK
C	Modify Reg 8 & 9	KK

REVISION RECORD		DATE:
LTR	ECD NO:	9/99
B	Faster Interface	KK
BT	Extra Memory	KK
C	Modify Reg 8 & 9	KK

REVISION RECORD		DATE:
LTR	ECD NO:	9/99
B	Faster Interface	KK
BT	Extra Memory	KK
C	Modify Reg 8 & 9	KK

REVISION RECORD		DATE:
LTR	ECD NO:	9/99
B	Faster Interface	KK
BT	Extra Memory	KK
C	Modify Reg 8 & 9	KK

REVISION RECORD		DATE:
LTR	ECD NO:	9/99
B	Faster Interface	KK
BT	Extra Memory	KK
C	Modify Reg 8 & 9	KK

REVISION RECORD		DATE:
LTR	ECD NO:	9/99
B	Faster Interface	KK
BT	Extra Memory	KK
C	Modify Reg 8 & 9	KK

REVISION RECORD		DATE:
LTR	ECD NO:	9/99
B	Faster Interface	KK
BT	Extra Memory	KK
C	Modify Reg 8 & 9	KK

**Regulators 1,2 & 7
require heatsinks
(Farnell No. 175-650)**

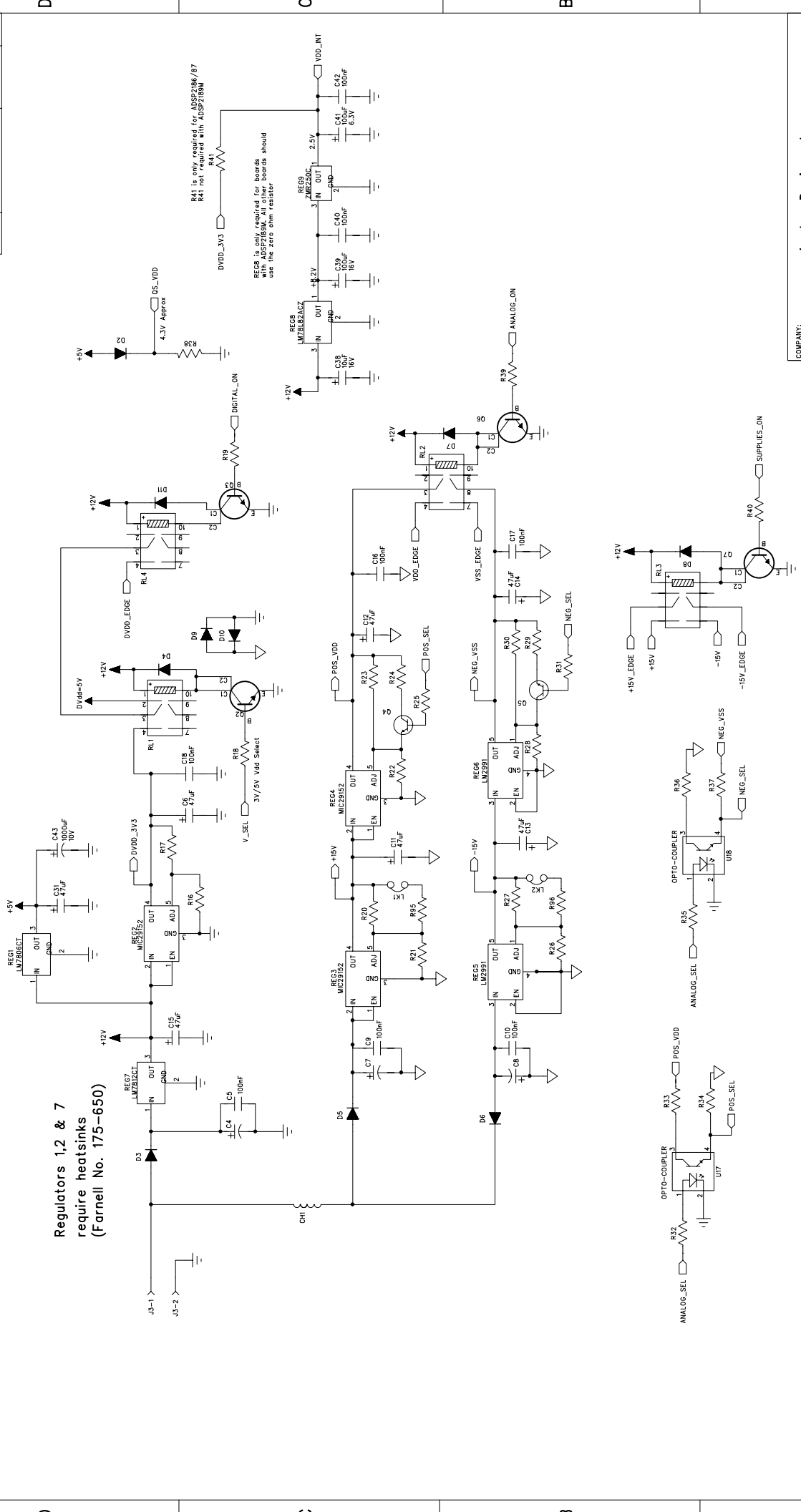

COMPANY:		Analog Devices Inc.	
TITLE:			
Evaluation Control Board Power Supply Section			
DRAWN:	Pat. Sheehan	DATE:	9/99
CHECKED:	Ken Karanagh	DATE:	9/99
QUALITY CONTROL:		DATE:	
RELEASED:		DATE:	
SIZE:		DRAWING NO:	EVAL-CONTROL BOARD
REV:			C
SCALE:		SHEET:	1 OF 3

COMPANY:		Analog Devices Inc.	
TITLE:			
Evaluation Control Board Power Supply Section			
DRAWN:	Pat. Sheehan	DATE:	9/99
CHECKED:	Ken Karanagh	DATE:	9/99
QUALITY CONTROL:		DATE:	
RELEASED:		DATE:	
SIZE:		DRAWING NO:	EVAL-CONTROL BOARD
REV:			C
SCALE:		SHEET:	1 OF 3

COMPANY:		Analog Devices Inc.	
TITLE:			
Evaluation Control Board Power Supply Section			
DRAWN:	Pat. Sheehan	DATE:	9/99
CHECKED:	Ken Karanagh	DATE:	9/99
QUALITY CONTROL:		DATE:	
RELEASED:		DATE:	
SIZE:		DRAWING NO:	EVAL-CONTROL BOARD
REV:			C
SCALE:		SHEET:	1 OF 3

COMPANY:		Analog Devices Inc.	
TITLE:			
Evaluation Control Board Power Supply Section			
DRAWN:	Pat. Sheehan	DATE:	9/99
CHECKED:	Ken Karanagh	DATE:	9/99
QUALITY CONTROL:		DATE:	
RELEASED:		DATE:	
SIZE:		DRAWING NO:	EVAL-CONTROL BOARD
REV:			C
SCALE:		SHEET:	1 OF 3

COMPANY:		Analog Devices Inc.	
TITLE:			
Evaluation Control Board Power Supply Section			
DRAWN:	Pat. Sheehan	DATE:	9/99
CHECKED:	Ken Karanagh	DATE:	9/99
QUALITY CONTROL:		DATE:	
RELEASED:		DATE:	
SIZE:		DRAWING NO:	EVAL-CONTROL BOARD
REV:			C
SCALE:		SHEET:	1 OF 3

COMPANY:		Analog Devices Inc.	
TITLE:			
Evaluation Control Board Power Supply Section			
DRAWN:	Pat. Sheehan	DATE:	9/99
CHECKED:	Ken Karanagh	DATE:	9/99
QUALITY CONTROL:		DATE:	
RELEASED:		DATE:	
SIZE:		DRAWING NO:	EVAL-CONTROL BOARD
REV:			C
SCALE:		SHEET:	1 OF 3

COMPANY:		Analog Devices Inc.	
TITLE:			
Evaluation Control Board Power Supply Section			
DRAWN:	Pat. Sheehan	DATE:	9/99
CHECKED:	Ken Karanagh	DATE:	9/99
QUALITY CONTROL:		DATE:	
RELEASED:		DATE:	
SIZE:		DRAWING NO:	EVAL-CONTROL BOARD
REV:			C
SCALE:		SHEET:	1 OF 3

COMPANY:		Analog Devices Inc.	
TITLE:			
Evaluation Control Board Power Supply Section			
DRAWN:	Pat. Sheehan	DATE:	9/99
CHECKED:	Ken Karanagh	DATE:	9/99
QUALITY CONTROL:		DATE:	
RELEASED:		DATE:	
SIZE:		DRAWING NO:	EVAL-CONTROL BOARD
REV:			C
SCALE:		SHEET:	1 OF 3

COMPANY:		Analog Devices Inc.	
TITLE:			
Evaluation Control Board Power Supply Section			
DRAWN:	Pat. Sheehan	DATE:	9/99
CHECKED:	Ken Karanagh	DATE:	9/99
QUALITY CONTROL:		DATE:	
RELEASED:		DATE:	
SIZE:		DRAWING NO:	EVAL-CONTROL BOARD
REV:			C
SCALE:		SHEET:	1 OF 3

REVISION RECORD		
LTR	ECD NO:	APPROVED: DATE:

1

2

3

4

5

6

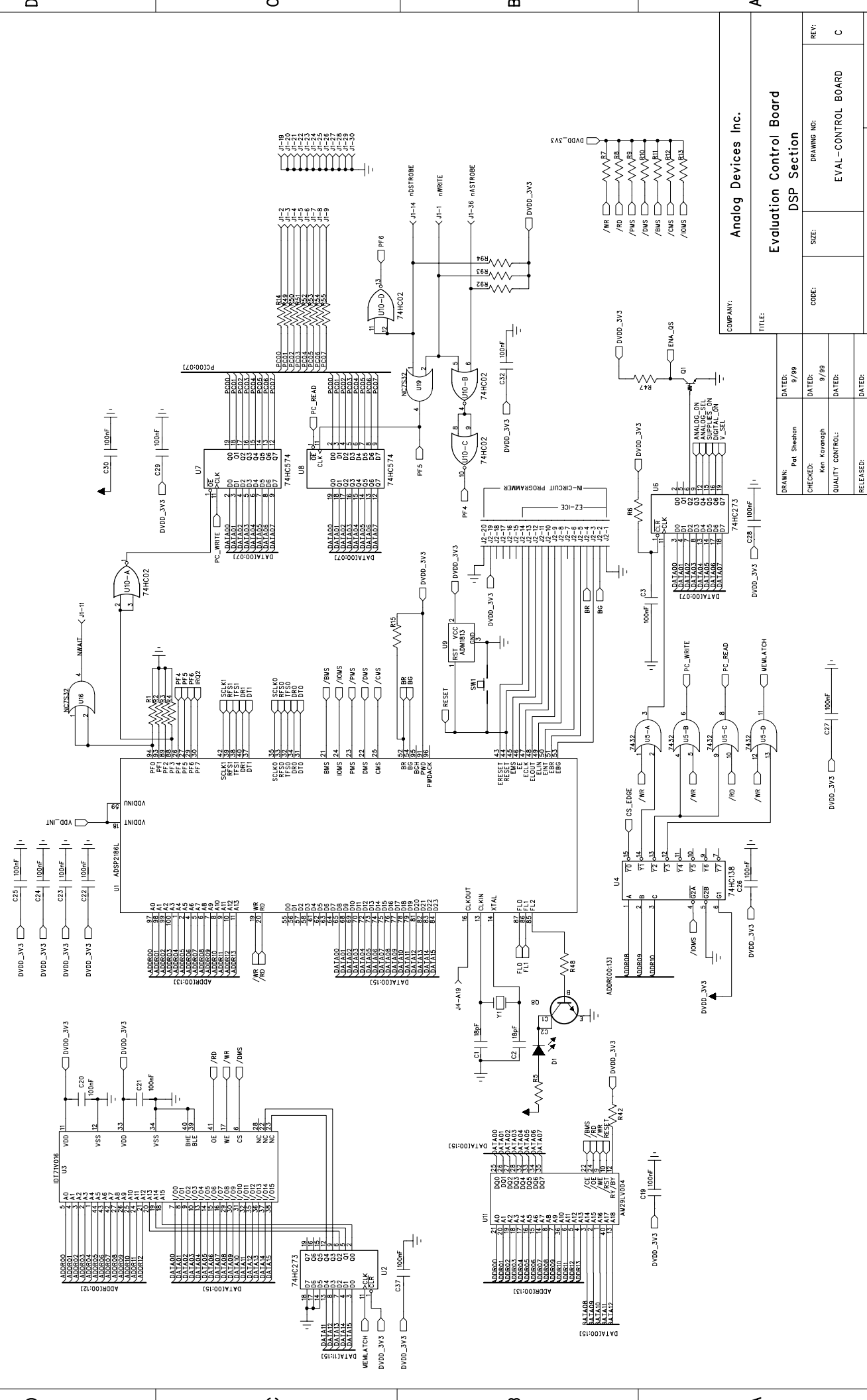

COMPANY: Analog Devices Inc.	
TITLE: Evolution Control Board DSP Section	
DRAWN: Pat Sheehan	DATE: 9/99
CHECKED: Ken Kevenagh	DATE: 9/99
QUALITY CONTROL:	DATE:
RELEASED:	DATE:

DRAWING NO: EVAL-CONTROL BOARD	REV: C
SIZE:	CODE:
SCALE: SHEET: 2 OF 3	

1

2

3

4

5

6

REVISION RECORD		
LTR	ECD NO:	APPROVED: DATE:

1

2

3

4

5

6

D

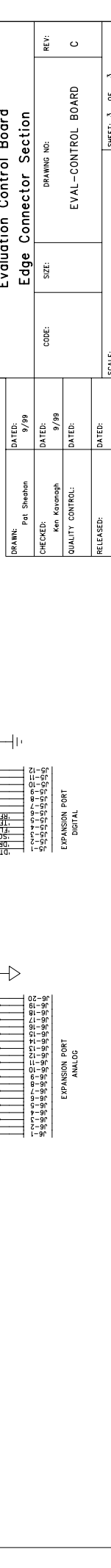
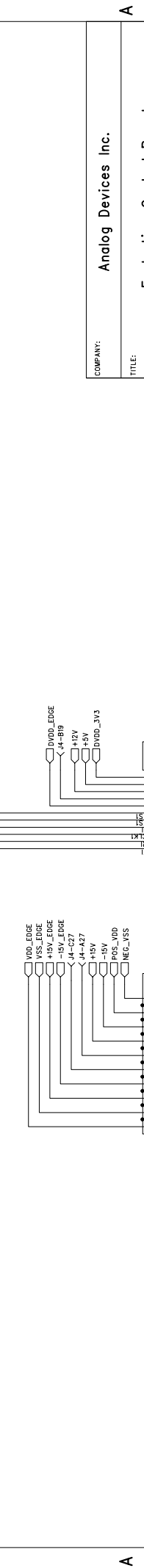
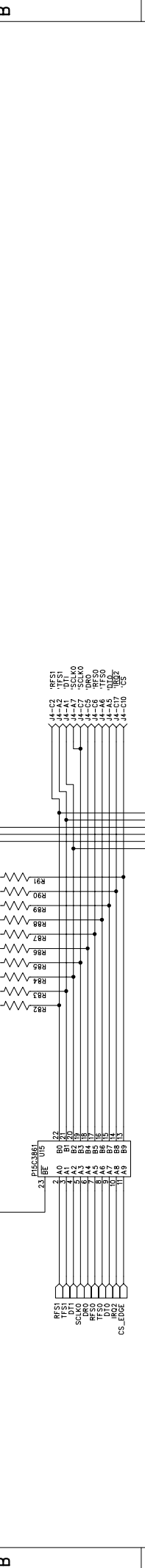
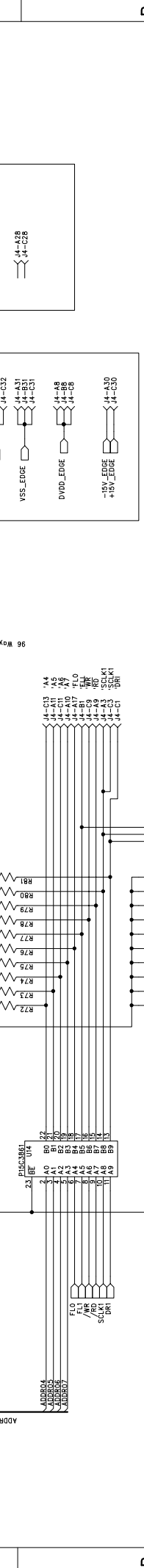
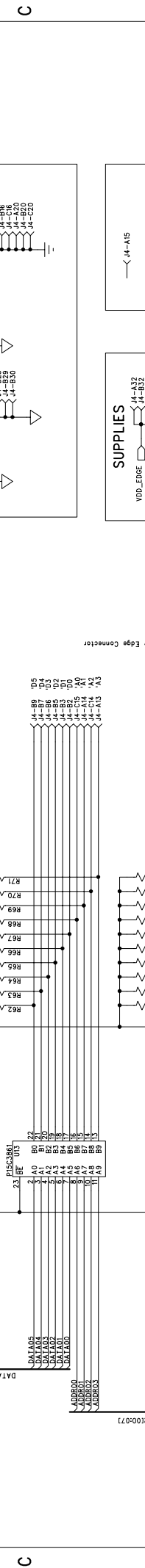
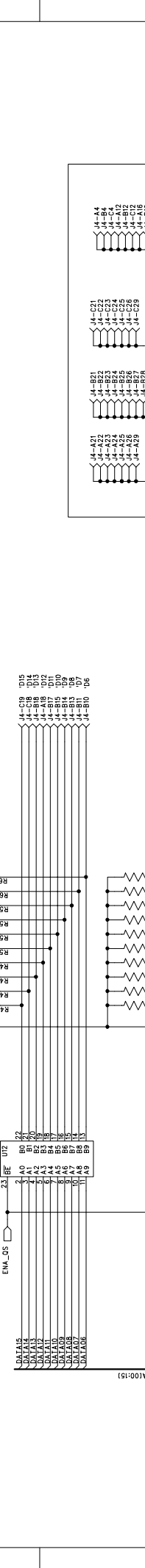
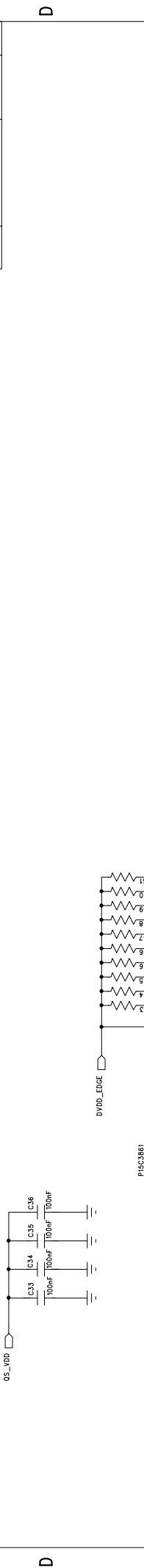

D

C

B

A

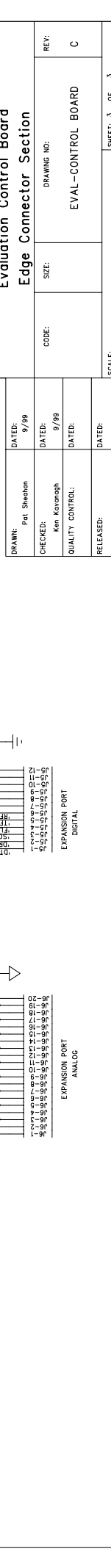
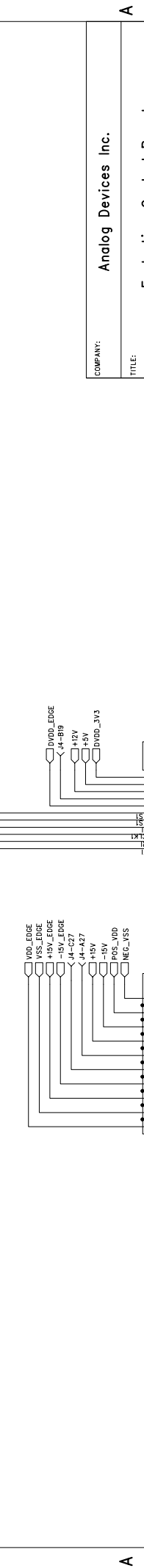
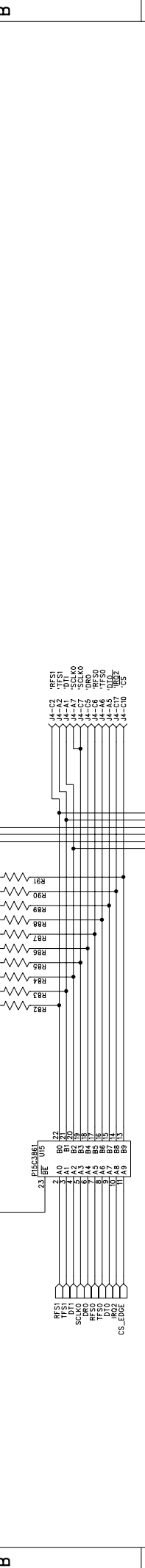
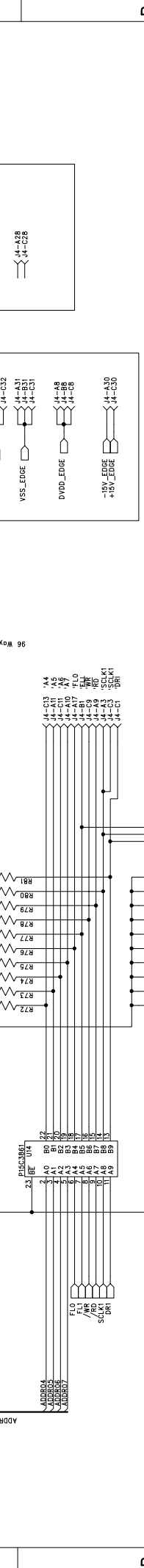

D

C

B

A

SUPPLIES

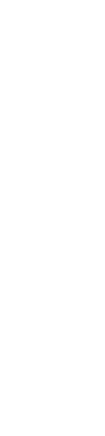
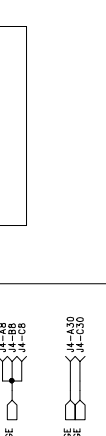

COMPANY:		Analog Devices Inc.	
TITLE:			
Evolution Control Board Edge Connector Section			
DRAWN:	Pat Sheehan	DATED:	9/99
CHECKED:	Ken Kevanagh	DATED:	9/99
QUALITY CONTROL:		DATED:	
RELEASED:		DATED:	
SIZE:		DRAWING NO:	EVAL-CONTROL BOARD
CODE:		REV:	C
SCALE:			SHEET: 3 OF 3

EVAL-CONTROL BRD2 Bill of Materials

Capacitors

Quantity	RefDes	PartType	Disti / Part Number	PartDecal	SMD
2	C1 C2	22pF Multilayer Ceramic Capacitor (0603 case size)	FEC 498-543	0603	TRUE
12	C3 C5 C9 C10 C16-18 C29-30 C32 C40 C42	0.1uF Multilayer Ceramic Capacitor (0805 case size)	FEC 317-676	0805	TRUE
3	C4 C7 C8	2200uF 25V Radial Electrolytic Capacitor	FEC 286-424	BIGCAP	FALSE
7	C6 C11-15 C31	47uF 16V Radial Electrolytic Capacitor	FEC 921-129	DCAPISR21	FALSE
15	C19-28 C33-37	0.1uF Multilayer Ceramic Capacitor (0603 case size)	FEC 317-287	0603	TRUE
1	C38	10uF 16V Radial Electrolytic Capacitor	FEC 921-099	DCAPISR21	FALSE
2	C39 C41	100uF 16V Radial Electrolytic Capacitor	FEC 921-130	DCAPISR21	FALSE
1	C43	1000uF 10V Radial Electrolytic Capacitor	FEC 921-051	BIGCAP1	FALSE

Resistors

Quantity	RefDes	PartType	Disti / Part Number	PartDecal	SMD
49	R1-4 R15 R42-46 R56-94	100KΩ ±1% 0.063W Resistor (0603 Case)	FEC 911-471	0603	TRUE
1	R5	560Ω ±1% 0.1W Resistor (0805 Case)	FEC 911-823	0805	TRUE
3	R34 R37 R48	100KΩ ±1% 0.1W Resistor (0805 Case)	FEC 912-098	0805	TRUE
8	R6-13	10KΩ ±1% 0.063W Resistor (0603 Case)	FEC 911-355	0603	TRUE
8	R14 R49-55	0Ω ±1% 0.1W Resistor (0805 Case)	FEC 772-239	0805	TRUE
11	R18-19 R25 R31-R33 R35 R36 R38-R40 R47	1KΩ ±1% 0.1W Resistor (0805 Case)	FEC 911-859	0805	TRUE
1	R41 (Not Used with ADSP2189 Model)	not used	FEC 772-239	0805	TRUE
1	R16	820Ω ±1% 0.1W Resistor (0805 Case)	FEC 911-847	0805	TRUE
1	R17	1.3KΩ ±1% 0.1W Resistor (0805 Case)	FEC 554-110	0805	TRUE
1	R20	42KΩ ±1% 0.1W Resistor (0805 Case)	FEC 554-431	0805	TRUE
1	R21	255Ω ±0.1% 0.1W Resistor (0805 Case)	FEC 553-438	0805	TRUE
1	R22	620Ω ±1% 0.1W Resistor (0805 Case)	FEC 771-314	0805	TRUE
1	R23	2KΩ ±1% 0.1W Resistor (0805 Case)	FEC 554-297	0805	TRUE
1	R24	4.32KΩ ±1% 0.1W Resistor (0805 Case)	FEC 554-613	0805	TRUE
1	R26	1.6KΩ ±1% 0.1W Resistor (0805 Case)	FEC 771-363	0805	TRUE
1	R27	18KΩ ±1% 0.1W Resistor (0805 Case)	FEC 912-001	0805	TRUE
1	R28	1.2KΩ ±1% 0.1W Resistor (0805 Case)	FEC 911-860	0805	TRUE
1	R29	2.7KΩ ±1% 0.1W Resistor (0805 Case)	FEC 911-902	0805	TRUE
1	R30	3.9KΩ ±1% 0.1W Resistor (0805 Case)	FEC 911-926	0805	TRUE
1	R95	10KΩ ±1% 0.1W Resistor (0805 Case)	FEC 911-975	0805	TRUE
1	R96	69KΩ ±1% 0.1W Resistor (0805 Case)	FEC 555-770	0805	TRUE

Ferrite Beads

Quantity	RefDes	PartType	Disti / Part Number	PartDecal	SMD
1	CH1	BEAD	FEC 108-267	28C0236-OBS	FALSE

Diodes

Quantity	RefDes	PartType	Disti / Part Number	PartDecal	SMD
1	D1	LED (3mm Red)	FEC 472-281	LED	FALSE
10	D2-D11	DIODE,1N4001	FEC 251-677	DO35	FALSE

Connectors

Quantity	RefDes	PartType	Disti / Part Number	PartDecal	SMD
1	J1	36 Pin 90° Centronics connector	FEC 147-753	36WAY	FALSE
1	J2	20 Pin (10x2) Header Depopulate pins 7,15,16,17,18	FEC 511-833	HEADER14-POL	FALSE
1	J3	90° 2.5mm PCB Mount DC Power Socket	FEC 224-960	CONIBARREL	FALSE
1	J4	2.5mm DC Power Plug (Fit into power socket, J3)	FEC 224-935		
1	J3	96 Pin 90° DIN 41612 Socket	FEC 316-830	DIN41612-96-FEM	FALSE
1	J5	12 Pin (6x2) Extension Header	FEC 511-810	HEADER10	FALSE
1	J6	20 Pin (10x2) Extension Header	FEC 511-833	SIP-7P	FALSE
2	LK1 LK2	2 Pin SIL Header	FEC 511-705	JUMPER	FALSE
2	LK1 LK2	Shorting Terminal	FEC 148-029	JUMPER	FALSE

Transistors

Quantity	RefDes	PartType	Disti / Part Number	PartDecal	SMD
1	Q1	MMUN2216LT1	FEC 473-637	SOT23	TRUE
5	Q2 Q3 Q6 Q7 Q8	PZT2222AT1	FEC 932-875	SOT223	TRUE
2	Q4 Q5	BC818	FEC 934-197	SOT23-3	TRUE

Regulators

Quantity	RefDes	PartType	Disti / Part Number	PartDecal	SMD
1	REG1	LM7805CT	FEC 412-776	TO/220	FALSE
3	REG2-4	MIC29152BT	FEC 640-591	TO-220/5	FALSE
2	REG5-6	LM2991T	FEC 205-461	TO-220/5	FALSE
1	REG7	LM7812CT	FEC 413-215	TO/220	FALSE
1	REG8	LM78L82ACZ	FEC 413-010	TO-92	FALSE
1	REG9	ZMR250C	FEC 791-441	TO-92	FALSE

Relays/Switches

Quantity	RefDes	PartType	Disti / Part Number	PartDecal	SMD
4	RL1-4	RELAY_DPCO	FEC 177-226	RLY1	FALSE
1	SW1	SW-PUSH	FEC 733-430	SWPB-SMALL	FALSE

Integrated Circuits

Quantity	RefDes	PartType	Disti / Part Number	PartDecal	SMD
1	U1	ADSP2189MKST-300	ADI	TQFP100	TRUE
1	U3	K6R1016CIC	FEC 335-4921	SOJ44LM	TRUE
1	U4	74LCX138M	FEC 111-910	SO16NB	TRUE
1	U5	74LCX32M	FEC 111-983	SO14	TRUE
1	U2 U6	74LV273D	FEC 568-983	SO20WB	TRUE
1	U7	74VHC574M	FEC 676-238	SO20WB	TRUE
2	U8	74LCX574WM	FEC 112-045	SO20WB	TRUE
1	U9	ADM1818-20ART	ADI	SOT23	TRUE
1	U10	74LCX02M	FEC 111-879	SO14NB	TRUE
1	U11	AM29LV004BB-150EC (-120EC)	Macro Marketing Ltd	TSOP-40-3	TRUE
4	U12-15	PI5C3861Q	DigiKey (PI5C3861Q-ND)	QSOP24	TRUE
1	U16 U19	NC7S32M5	FEC 685-940	SOT23-5	TRUE
2	U17-18	OPTO-COUPLER (SFH610A-2)	FEC 212-556	DIP4	FALSE
1	Y1	XTAL1 (20MHz)	FEC 177-408	HC49/4	FALSE

Board Hardware

Quantity	RefDes	PartType	Disti / Part Number	PartDecal	SMD
2	X1 X2	H'SINK_SW25-4	FEC 175-650	SW25-4_H'SINK	FALSE
1	X3	H'SINK_ALU STRIP			
4	for Reg3-Reg6	Mica Washer for TO220	FEC 520-214		FALSE
4	for Reg3-Reg6	Sil Pad	FEC 936-741		
1	Bare Board	Evaluation Control Board (Rev. C)			

Misc Hardware

4	Rubber stick-on feet	Fixed to underside of board at each corner.	FEC 148-922		
1	Centronics Printer Cables	1 printer cable included in each box.	FEC 960-524		
1	Anti-Static Bag	Place tested board in anti-static bag.	FEC 522-788		
1	Bar Code Box Label	Fix label to front of box.	ADI Supplied		
1	Eval Control Board Tech Note	Loose in box.	ADI Supplied		
1	Evaluation Board Box (Small Size)		Europacks K-645/1		