

REVISIONS				
ZONE	REV	DESCRIPTION	DATE	APPROVED

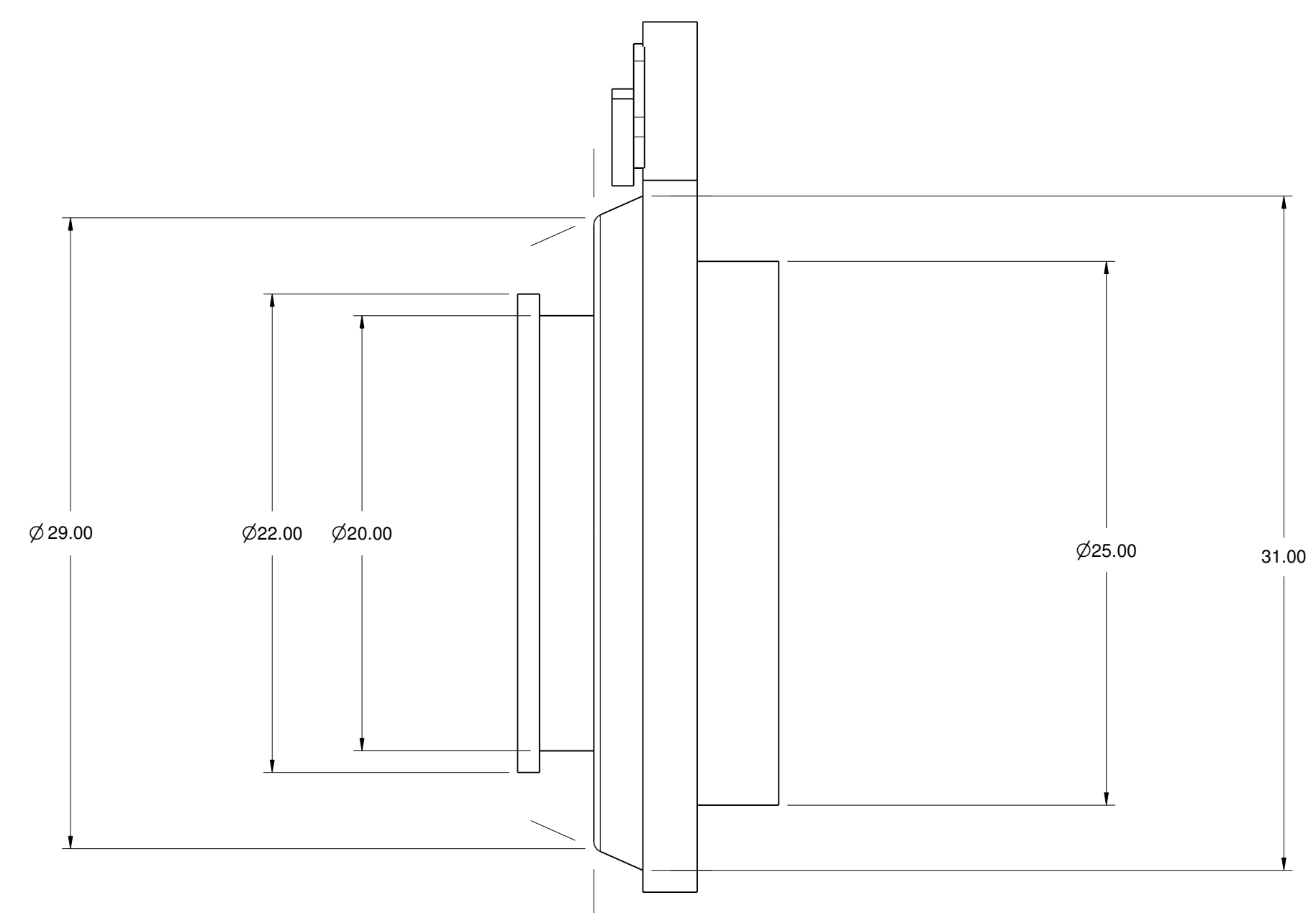
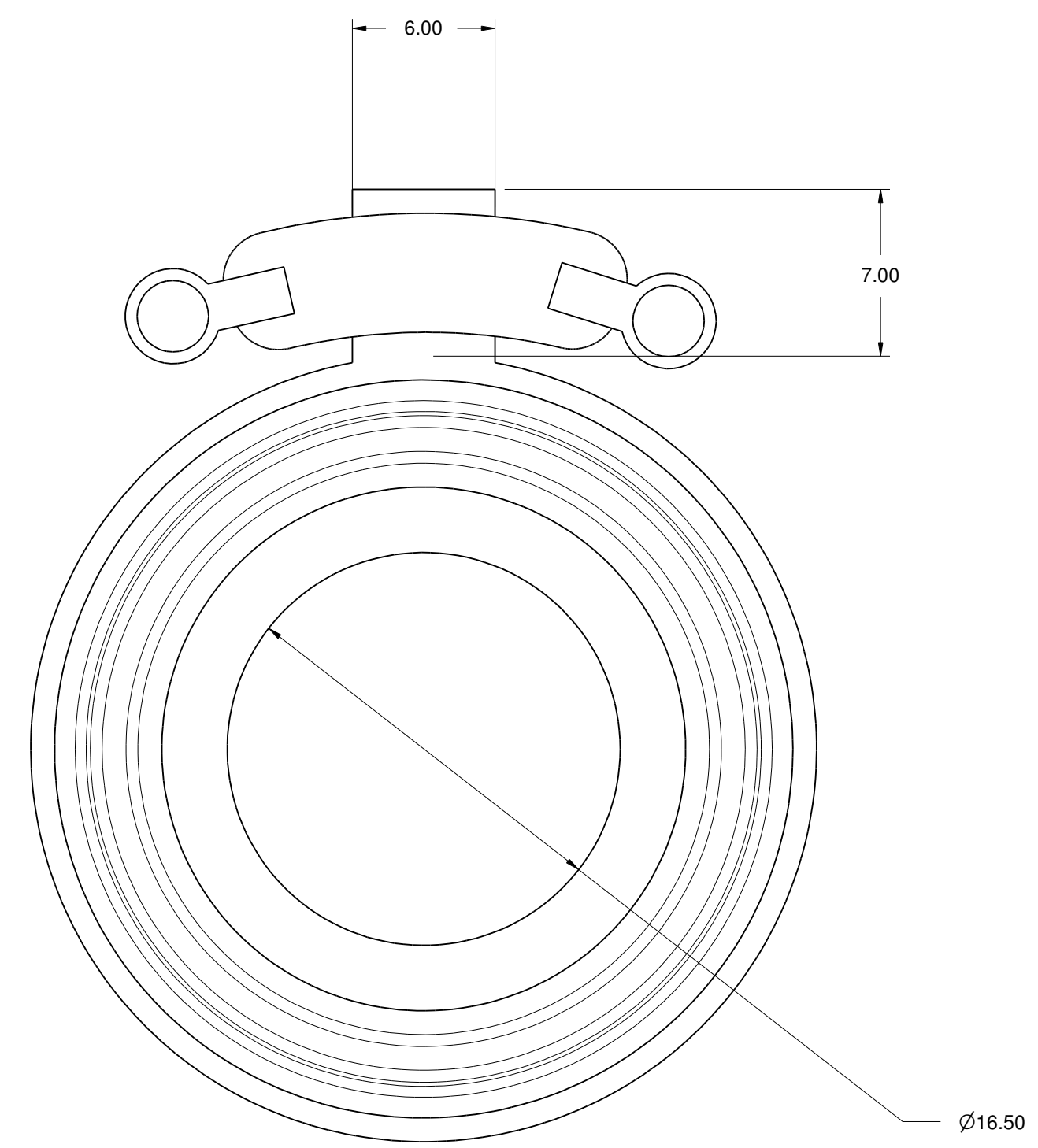
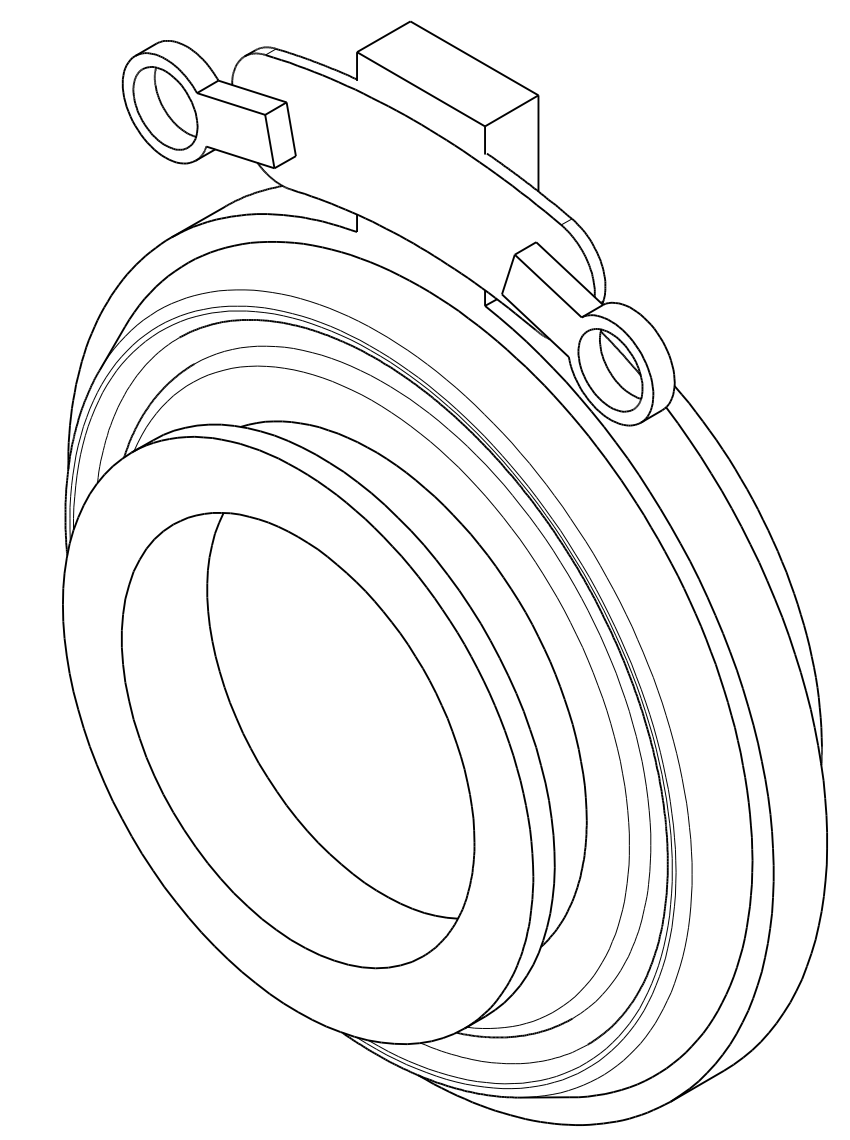

SIZE	FSCM NO.	DWG NO.	REV
D		E-3304	
SCALE	SHEET		1 OF 1
1:1			