



**Please note that Cypress is an Infineon Technologies Company.**

The document following this cover page is marked as “Cypress” document as this is the company that originally developed the product. Please note that Infineon will continue to offer the product to new and existing customers as part of the Infineon product portfolio.

**Continuity of document content**

The fact that Infineon offers the following product as part of the Infineon product portfolio does not lead to any changes to this document. Future revisions will occur when appropriate, and any changes will be set out on the document history page.

**Continuity of ordering part numbers**

Infineon continues to support existing part numbers. Please continue to use the ordering part numbers listed in the datasheet for ordering.

# FM4-216-ETHERNET

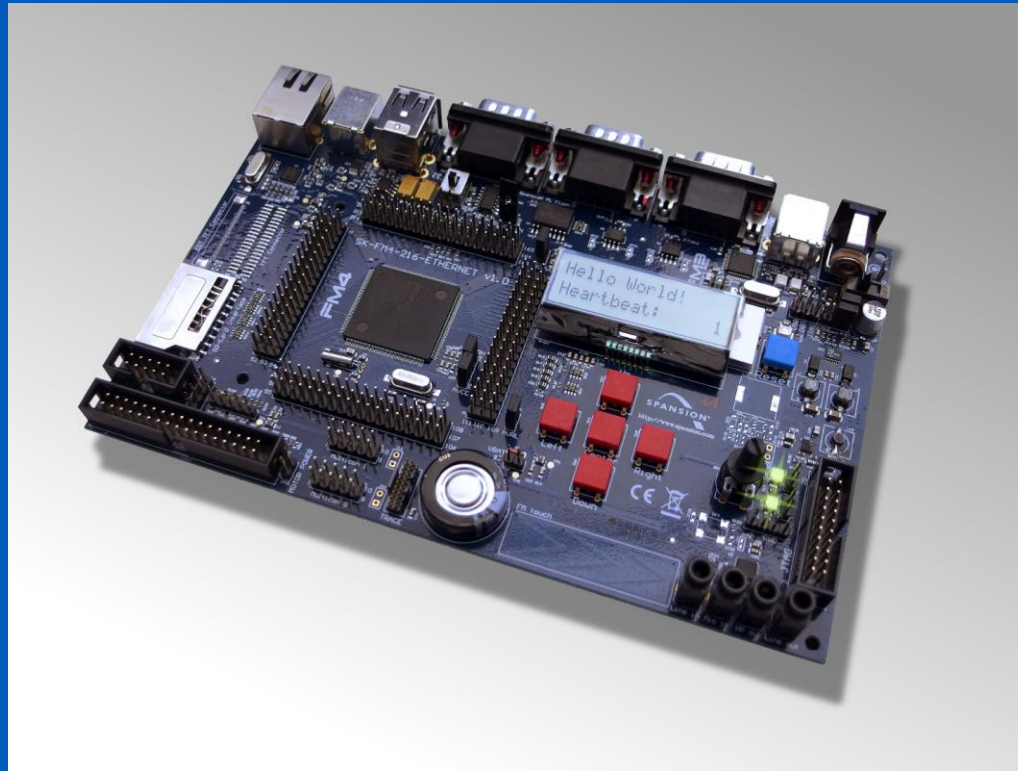

Hardware V1.0 / Documentation V1.3

Document Number: 002-09877 Rev. \*B

# Warranty and Disclaimer



© Cypress Semiconductor Corporation, 2014-2019. This document is the property of Cypress Semiconductor Corporation and its subsidiaries, including Spansion LLC (“Cypress”). This document, including any software or firmware included or referenced in this document (“Software”), is owned by Cypress under the intellectual property laws and treaties of the United States and other countries worldwide. Cypress reserves all rights under such laws and treaties and does not, except as specifically stated in this paragraph, grant any license under its patents, copyrights, trademarks, or other intellectual property rights. If the Software is not accompanied by a license agreement and you do not otherwise have a written agreement with Cypress governing the use of the Software, then Cypress hereby grants you a personal, non-exclusive, nontransferable license (without the right to sublicense) (1) under its copyright rights in the Software (a) for Software provided in source code form, to modify and reproduce the Software solely for use with Cypress hardware products, only internally within your organization, and (b) to distribute the Software in binary code form externally to end users (either directly or indirectly through resellers and distributors), solely for use on Cypress hardware product units, and (2) under those claims of Cypress’s patents that are infringed by the Software (as provided by Cypress, unmodified) to make, use, distribute, and import the Software solely for use with Cypress hardware products. Any other use, reproduction, modification, translation, or compilation of the Software is prohibited.

TO THE EXTENT PERMITTED BY APPLICABLE LAW, CYPRESS MAKES NO WARRANTY OF ANY KIND, EXPRESS OR IMPLIED, WITH REGARD TO THIS DOCUMENT OR ANY SOFTWARE OR ACCOMPANYING HARDWARE, INCLUDING, BUT NOT LIMITED TO, THE IMPLIED WARRANTIES OF MERCHANTABILITY AND FITNESS FOR A PARTICULAR PURPOSE. To the extent permitted by applicable law, Cypress reserves the right to make changes to this document without further notice. Cypress does not assume any liability arising out of the application or use of any product or circuit described in this document. Any information provided in this document, including any sample design information or programming code, is provided only for reference purposes. It is the responsibility of the user of this document to properly design, program, and test the functionality and safety of any application made of this information and any resulting product. Cypress products are not designed, intended, or authorized for use as critical components in systems designed or intended for the operation of weapons, weapons systems, nuclear installations, life-support devices or systems, other medical devices or systems (including resuscitation equipment and surgical implants), pollution control or hazardous substances management, or other uses where the failure of the device or system could cause personal injury, death, or property damage (“Unintended Uses”). A critical component is any component of a device or system whose failure to perform can be reasonably expected to cause the failure of the device or system, or to affect its safety or effectiveness. Cypress is not liable, in whole or in part, and you shall and hereby do release Cypress from any claim, damage, or other liability arising from or related to all Unintended Uses of Cypress products. You shall indemnify and hold Cypress harmless from and against all claims, costs, damages, and other liabilities, including claims for personal injury or death, arising from or related to any Unintended Uses of Cypress products.

Cypress, the Cypress logo, Spansion, the Spansion logo, and combinations thereof, WICED, PSoC, CapSense, EZ-USB, F-RAM, and Traveo are trademarks or registered trademarks of Cypress in the United States and other countries. For a more complete list of Cypress trademarks, visit [cypress.com](http://cypress.com). Other names and brands may be claimed as property of their respective owners.

- [MCU Features](#), [Board Features](#) & [Contents](#)
- [Test it](#)
- [The Hardware](#)
- [The Jumper Table](#) / [Jumper Default](#)
- [Board Power](#)
- [Software Examples & Tools](#)
- [Flash Programming](#)
- [JTAG / CMSIS-DAP](#)
- [IAR-Embedded Workbench](#)
- [KEIL  \$\mu\$ Vision](#)

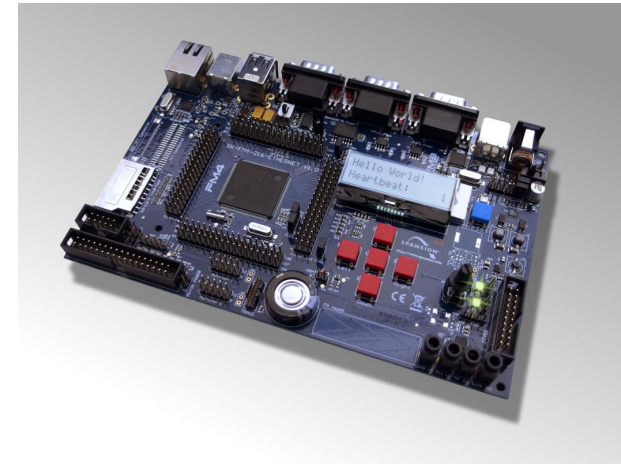

- [Additional documents](#)
  - [Schematics](#)
  - [Data sheet S6E2CC Series](#)
    - [Peripheral Manual](#)
      - [Timer part](#)
      - [Analog part](#)
      - [Communication part](#)
      - [Ethernet part](#)
    - [Flash programming manual](#)

# Features of the S6E2CC Microcontroller



RC oscillator +/-2%	<b>ARM Cortex-M4 – CPU</b> 200MHz (max) 2.7-5.5V MPU, FPU Ta= -40°C to +105°C  Main CLK: 4MHz SUB CLK: 32kHz MAIN RC CLK: 4MHz SUB RC CLK: 100kHz <b>FM4</b>	OCU x 6ch	ICU x 4ch
Clock Supervisor		ADT x 3ch	FRTim x 3ch
Subclock (option)		Multi Function Timer 3ch	Waveform Generator
Low Voltage Detector 2ch		PPG 9ch	QDU 4ch
SWJ/TPIU/ETM Debug Ports		Base Timer 16ch	External IRQs 32ch + NMI
MFS(UART/SPI/I <sup>2</sup> C) 16ch	Package: LQFP144, LQFP176, BGA192, LQFP 216,	Dual Timer	DMA 8ch
Quad SPI	S6E2CC8H/J/L FLASH 1MB SRAM 128K	Watch Counter	CRC
I2S	S6E2CC9H/J/L FLASH 1.5MB SRAM 192K	Resource Pin Relocation	RTC Y:M; h:m:s
CAN (32 MSB) 2ch	S6E2CCA H/J/L FLASH 2MB SRAM 256K	12-bit ADC	Hardware Watchdog
CAN-FD 1ch		12-bit ADC	DSTC 256ch
Ethernet MAC 10/100MBit		12-bit ADC	12-bit DAC 2ch
USB FS Host+Function 2ch			
SD Card I/F			
External Bus Interface (SRAM, SDRAM, NAND, ..)			

# Features of the board

## ■ Features of the FM4-216-ETHERNET board:

- Microcontroller Cypress FM4 S6E2CCAL0A
- FM *connect* Ethernet: 1x IEEE802.3 Ethernet
- FM *connect* CAN: 2x CAN transceiver + 1x CAN-FD transceiver
- FM *connect* USB: 2x USB-Host (Type-A connector), 1x USB-Device (Type-B connector)
- FM *touch*: Slider using four ADC channels
- FM *inverter*: Motor-Control-Interface for e.g. POWER-3P-LV2-MC
- FM *color*: Cypress S/W TFT interface
- Cypress flash memory S25FL164K, connected via quad SPI interface
- I<sup>2</sup>S audio interface
- SD Card interface
- 1x USB-to-serial JTAG converter (Type-B connector) using Cypress FM3 MB9AF312K
  - ✓ UART and on-board JTAG simultaneously (CMSIS DAP)
- Additional JTAG and Trace Interfaces each on a 20 pin-header
- 2x Cypress *Multicon* flexible serial interface supporting I<sup>2</sup>C, SPI, UART, and LIN
- User interface
  - ✓ Backlit LCD module
  - ✓ 5x pushbuttons (*User* buttons), potentiometer
  - ✓ 1x *Reset*-button, *Reset*-LED
- All 216 pins routed to pin-header
- On-board 5V and 3V voltage regulators to supply MCU with separate *Power*-LEDs
- 4x Power supply options: USB, USB-Device, JTAG or external 9V to 24V

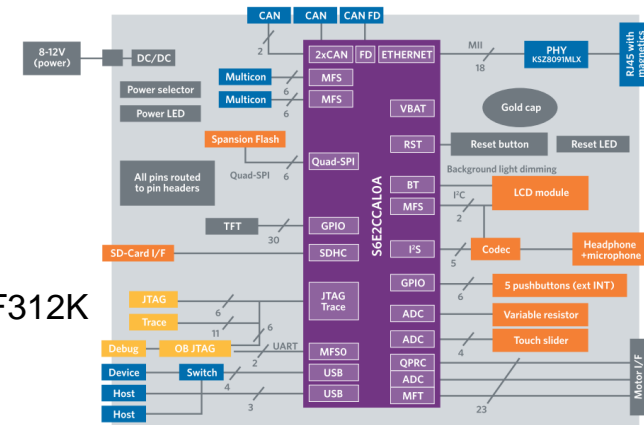

# Contents FM4-216-ETHERNET

- The FM4-216-ETHERNET box contains
  - The FM4-216-ETHERNET evaluation board
  - USB cable
  - Ethernet cable
  - CD: Documentation, software examples and development utilities
  - 1-page flyer

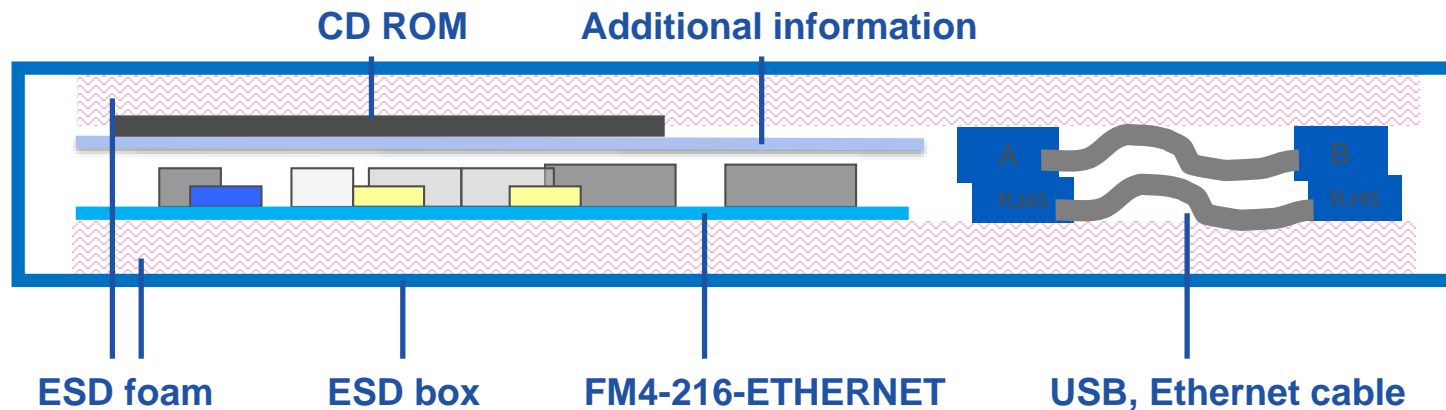

- The microcontroller on the FM4-216-ETHERNET is already preprogrammed with an example application (<drive:>\Examples\fm4-216-ethernet-tp\_v12.srec).
  - Verify that jumpers JP75 and JP77 are set to 1-2 position and jumper JP76 is set to 3-4 position
  - Connect the FM4-216-ETHERNET via DEBUG USB port (X2) with the PC
  - Verify that switch S1 is set to *RUN*
  - Press the *Reset*-button
  - The FM4-216-ETHERNET's display will show a greeting message
  - Using the Up and Down pushbuttons will scroll through a menu on the LCD module
- Connect X3 (static IP address 192.168.1.20) to a PC or local area network
  - Configure your PC to an untaken IP address within the same subnet (such as 192.168.1.42)
  - Point your webbrowser to board's IP address (192.168.1.20)
- Install the USB Driver first <drive:>\drivers\driverinstaller.exe
  - Check the availability for virtual COM port e.g. with Windows Device Manager
  - Open a serial terminal tool
  - e.g. Cypress Serial Port Viewer  
<drive:>\tools\serialportviewer\setup.exe
  - Settings 115200 baud, 8N1
  - More board tests are available via serial console



- You finished successfully the first tests

## Congratulations!

- Now you will get more details about the FM4-216-ETHERNET
- You will learn more about
  - The on-board features
  - How to program the Flash
  - How to start with IAR-Embedded-Workbench and KEIL  $\mu$ Vision



# Hardware

# The Hardware (Top Side) – Function Overview

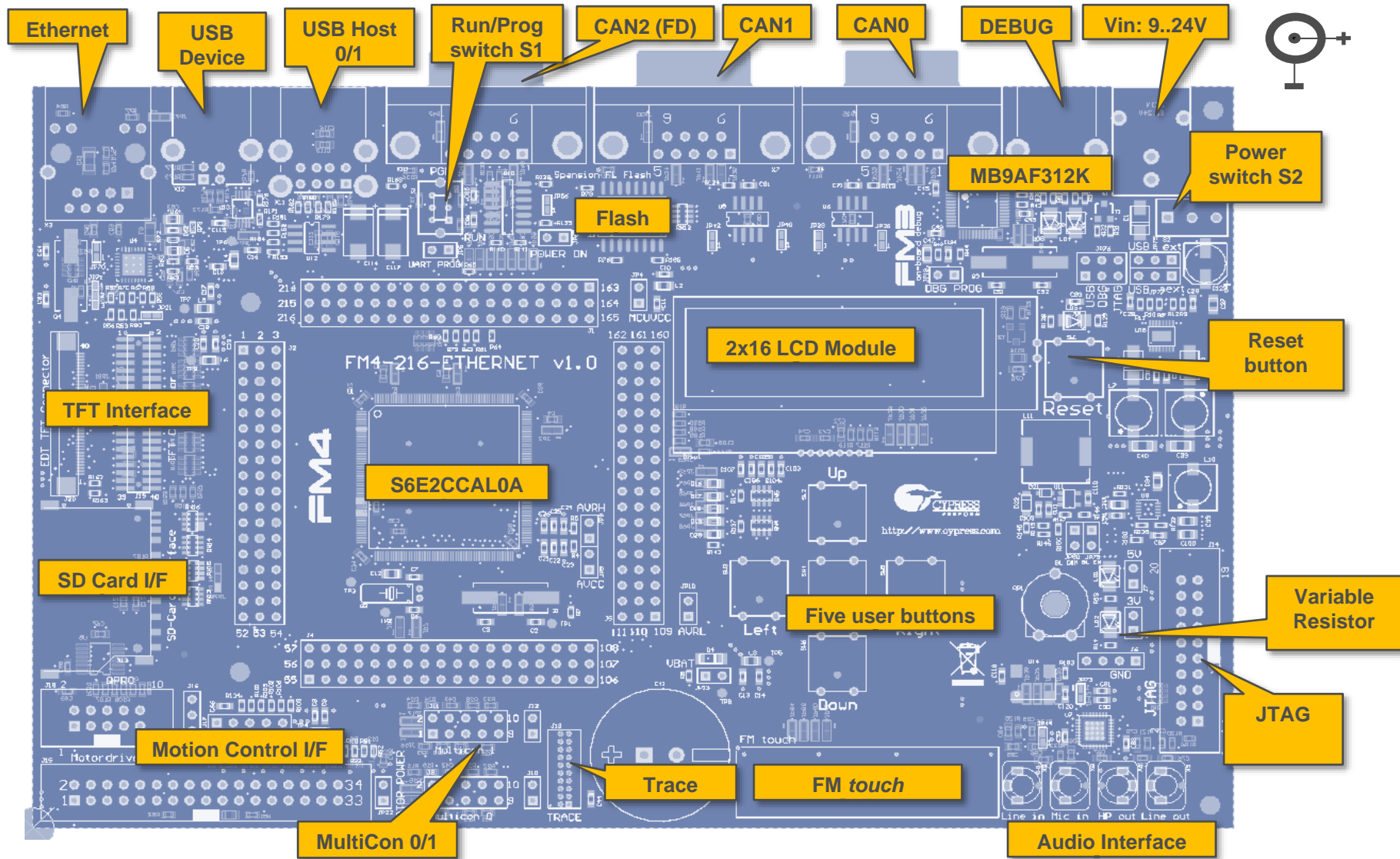

# Jumper Settings – Power the starterkit

- The starter kit can be powered by
  - External power supply (9-24V)
    - ✓ Set jumpers JP75 and JP77 to position 1-2
      - Caution: Always set JP75 and JP77 horizontally, never vertically!**
    - ✓ Connect X1 to 8..24V DC power
    - ✓ Switch S2 into ON position
  - USB
    - ✓ There are three ways to power the starter kit via USB
    - ✓ Set jumpers JP75 and JP77 to position 2-3
    - ✓ Set jumper JP76 according to the desired power source:

JP76	Power source	Connector
1-2	USB Device	X12
3-4	DEBUG	X2
5-6	JTAG (ensure that adapter can provide enough current for your application! Some JTAG probes source insufficient power and some features might misbehave unexpectedly)	J14

- For CAN2 (CAN FD), external power supply must be used, not USB

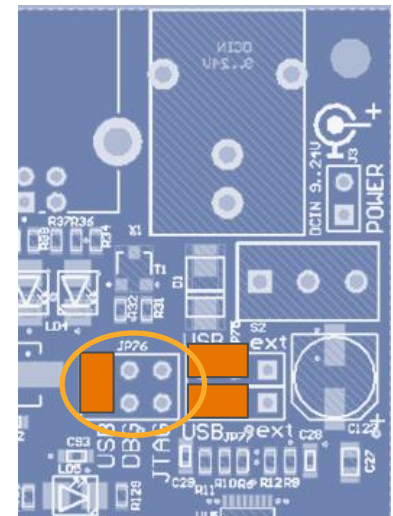
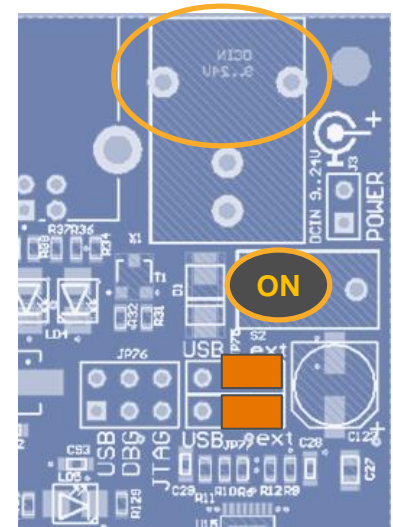

# The Hardware – Connectors

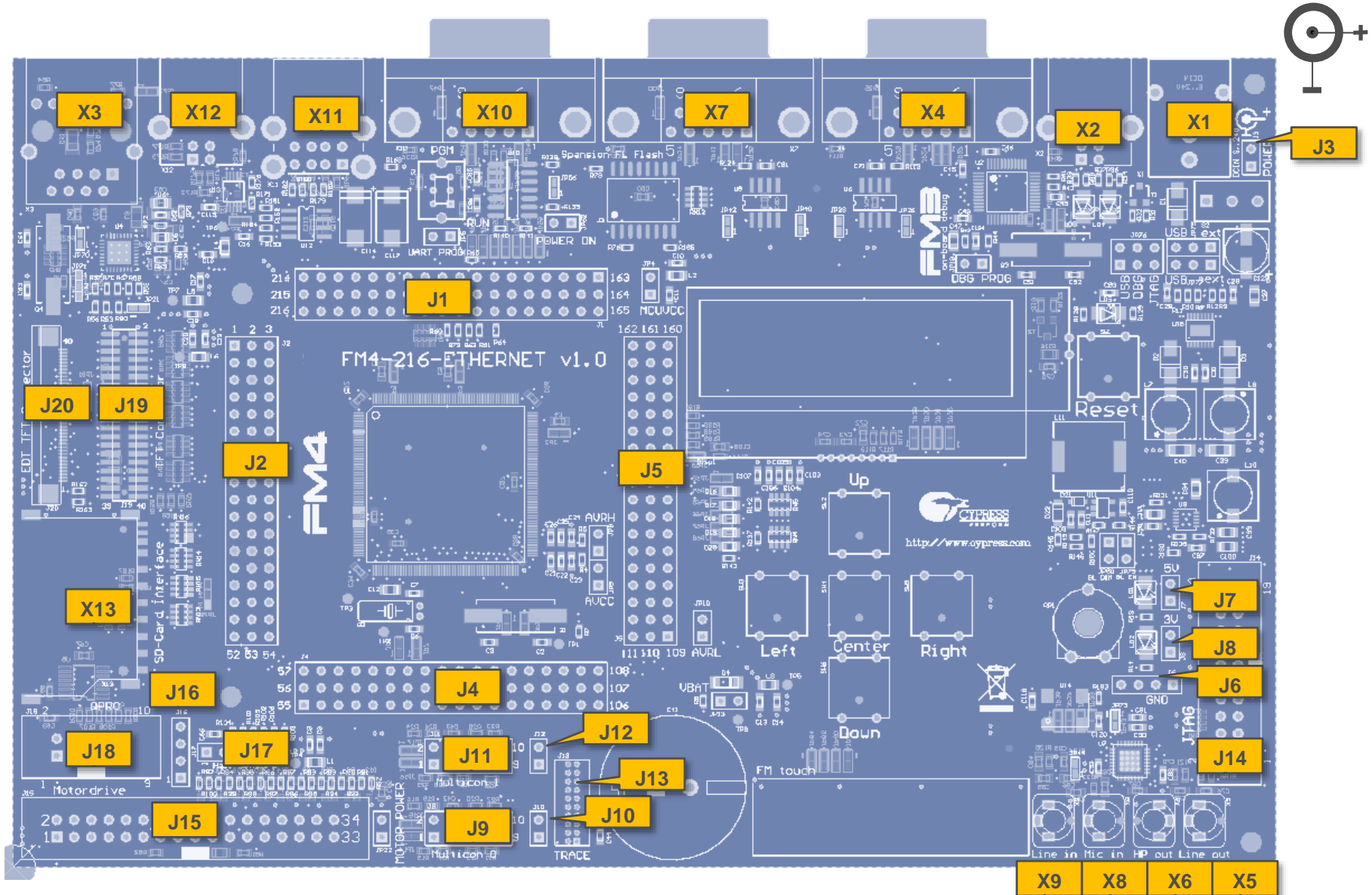

## Connectors FM4-216-ETHERNET

Number	Description
J1	MCU pins 163..216
J2	MCU pins 1..54
J3	VCCin (1: before switch, 2: after switch)
J4	MCU pins 55..108
J5	MCU pins 109..162
J6	4x GND
J7	2x 5V
J8	2x 3V3
J9	Multicon 0
[J10]	Multicon 0 optional
J11	Multicon 1
[J12]	Multicon 1 optional
J13	Trace
J14	JTAG
J15	Motor drive interface
J16	Motor I/F: Optional signals
J17	Hall Sensors
J18	QPRC
[J19]	Display RGB888 connector
[J20]	FPC/FCC connector

Number	Description
X1	DCin 9..24V
X2	Debug
X3	Ethernet
X4	CAN0
X5	Audio line out
X6	Audio headphones out
X7	CAN1
X8	Audio microphone in
X9	Audio line in
X10	CAN2 (CAN FD)
X11	USB Host (0/1)
X12	USB Device
X13	SD Card Connector

# Jumper Settings – (Top Side)

Regular Jumper  
Solder Jumper  
: default position

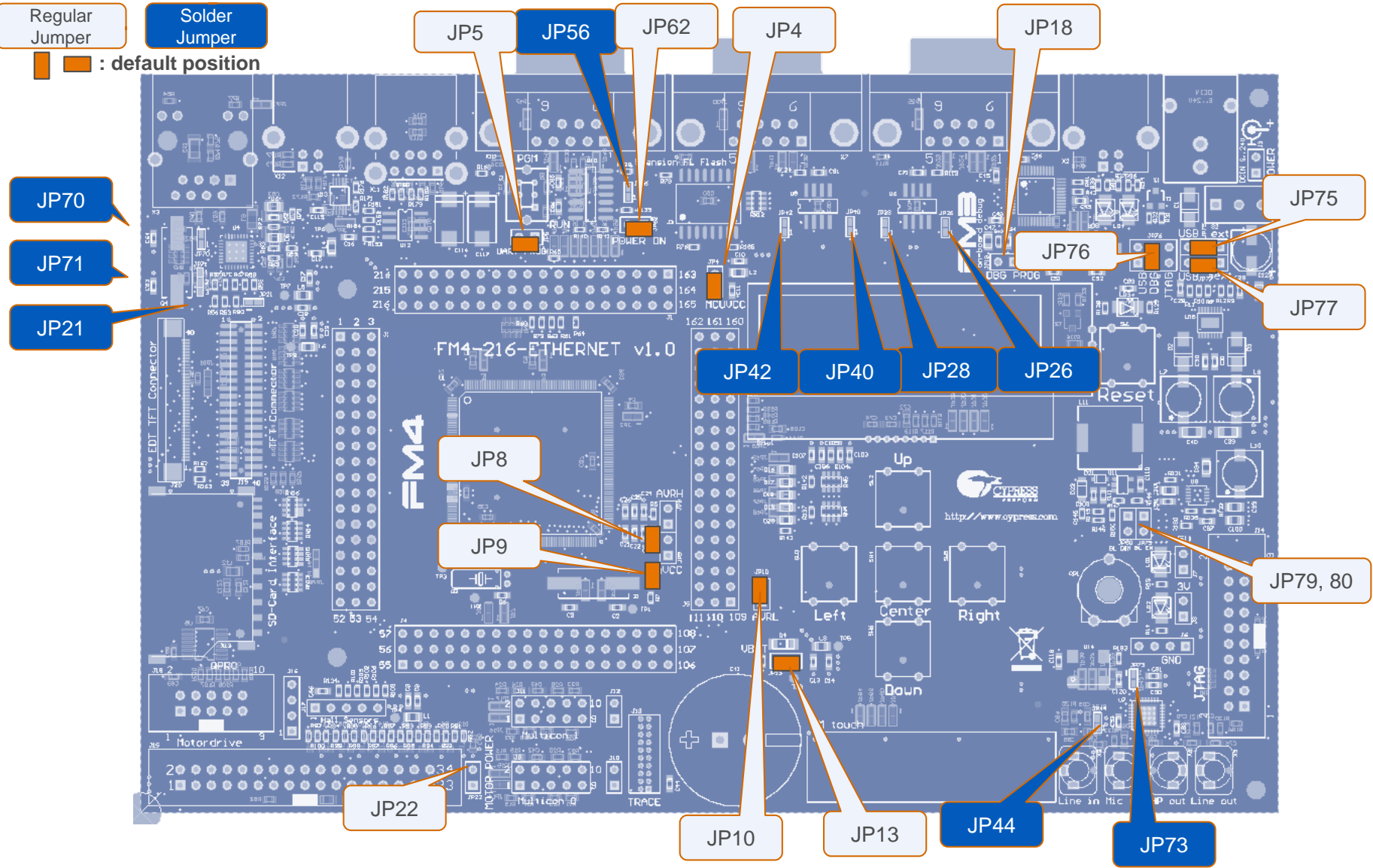



# Jumper Settings – (Bottom Side)

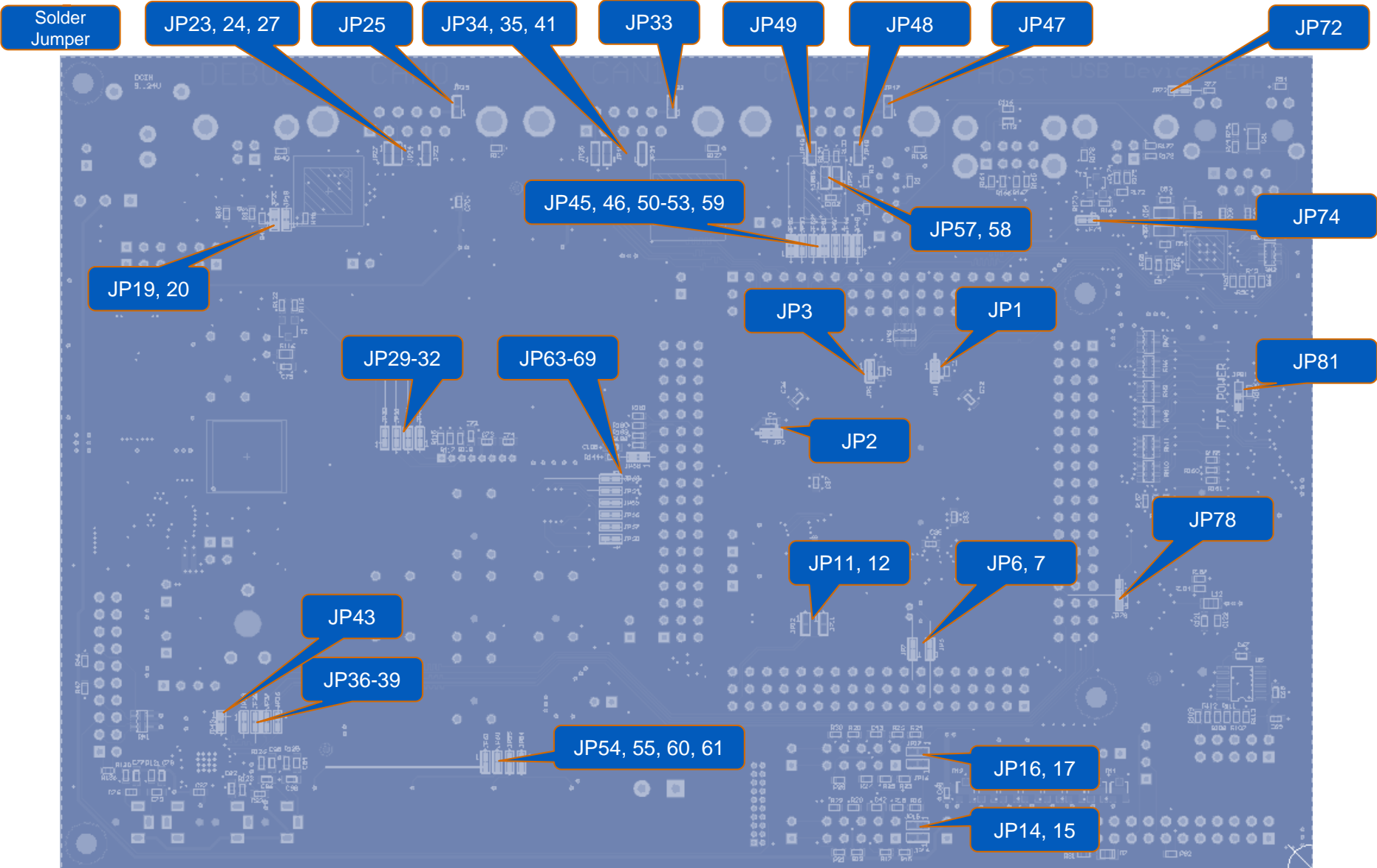



## Jumper Settings FM4-216-ETHERNET

Number	Description	Special Type	Default
JP1	USBVCC0	Solder Jumper	Closed
JP2	USBVCC1	Solder Jumper	Closed
JP3	ETHVCC	Solder Jumper	Closed
JP4	MCUVCC		Closed
JP5	USB/UART programming		Closed
JP6	X0A Access	Solder Jumper	Closed
JP7	X1A Access	Solder Jumper	Closed
JP8	AVRH		Closed
JP9	AVCC		Closed
JP10	AVRL		Closed
JP11	X0 Access	Solder Jumper	Open
JP12	X1 Access	Solder Jumper	Open
JP13	VBAT		Closed
JP14	Multicon0: SCL pull-up	Solder Jumper	Open
JP15	Multicon0: SDA pull-up	Solder Jumper	Open
JP16	Multicon1: SCL pull-up	Solder Jumper	Open
JP17	Multicon1: SDA pull-up	Solder Jumper	Open
JP18	DBG Prog (S/W upgrade U2)		Open

Number	Description	Special Type	Default
JP19	MFS0_SOT	Solder Jumper	Closed
JP20	MFS0_SIN	Solder Jumper	Closed
JP21	EthPHY IRQ	Solder Jumper	Closed
JP22	Supply VCCin from motor		Open
JP23	CAN0GND4	Solder Jumper	Open
JP24	CAN0GND6	Solder Jumper	Open
JP25	CAN0pwr	Solder Jumper	Open
JP26	CAN0RX	Solder Jumper	Closed
JP27	CAN0term	Solder Jumper	Open
JP28	CAN0TX	Solder Jumper	Closed
JP29	LCDRST	Solder Jumper	Closed
JP30	HMISCL	Solder Jumper	Closed
JP31	HMISDA	Solder Jumper	Closed
JP32	LCDBL	Solder Jumper	Closed
JP33	CAN1pwr	Solder Jumper	Open
JP34	CAN1GND4	Solder Jumper	Open
JP35	CAN1GND6	Solder Jumper	Open
JP36	I2SDO	Solder Jumper	Closed

## Jumper Settings FM4-216-ETHERNET

Number	Description	Special Type	Default
JP37	I2SDI	Solder Jumper	Closed
JP38	I2SCK	Solder Jumper	Closed
JP39	I2SWS	Solder Jumper	Closed
JP40	CAN1RX	Solder Jumper	Closed
JP41	CAN1term	Solder Jumper	Open
JP42	CAN1TX	Solder Jumper	Closed
JP43	I2SMCLK	Solder Jumper	Closed
JP44	I2SAGND	Solder Jumper	Closed
JP45	CAN2RX	Solder Jumper	Closed
JP46	CAN2TX	Solder Jumper	Closed
JP47	CAN2pwr	Solder Jumper	Open
JP48	CAN2GND4	Solder Jumper	Open
JP49	CAN2GND6	Solder Jumper	Open
JP50	CAN2S	Solder Jumper	Closed
JP51	CAN2C	Solder Jumper	Closed
JP52	CAN2O	Solder Jumper	Closed
JP53	CAN2I	Solder Jumper	Closed
JP54	Touch AN24	Solder Jumper	Closed

Number	Description	Special Type	Default
JP55	Touch AN25	Solder Jumper	Closed
JP56	CANFDBAT	Solder Jumper	Closed
JP57	CAN2termH	Solder Jumper	Open
JP58	CAN2termL	Solder Jumper	Open
JP59	CAN2Wake	Solder Jumper	Closed
JP60	Touch AN26	Solder Jumper	Closed
JP61	Touch AN27	Solder Jumper	Closed
JP62	POWERON		Closed
JP63	Button UP	Solder Jumper	Closed
JP64	Button RIGHT	Solder Jumper	Closed
JP65	Button CENTER	Solder Jumper	Closed
JP66	Button LEFT	Solder Jumper	Closed
JP67	Button DOWN	Solder Jumper	Closed
JP68	Button IRQ	Solder Jumper	Closed
JP69	RP1	Solder Jumper	Closed
JP70	EthPHY XO	Solder Jumper	Closed
JP71	EthPHY XI	Solder Jumper	Closed
JP72	Ethernet Yellow LED	Solder Jumper	Closed

## Jumper Settings FM4-216-ETHERNET

Number	Description	Special Type	Default
JP73	I2S48.1k	Solder Jumper	Closed
JP74	USB HCONX	Solder Jumper	Closed
JP75	1-2: External power supply 2-3: Supply via USB or JTAG	JP75 must equal 77	1-2
JP76	1-2: USB Device (X11) 3-4: Debug port (X2) 5-6: JTAG (J11) (watch voltage!)	Only relevant if JP75 and JP77 set to 2-3	3-4
JP77	1-2: External power supply 2-3: Supply via USB or JTAG	JP75 must equal 77	1-2
JP78	SD_CD: 1-2: CD 2-3: CD/DAT3	Solder Jumper	1-2
[JP79]	Backlight enable		Open
[JP80]	Backlight dimming		Open
[JP81]	LCD power control		1-2

## Pin-List FM4-216-ETHERNET (1/9)

Pin	Function	Description
1	VCC	MCUVCC
2	PA0/RTO20_0/TIOA8_0/AIN2_0/INT00_0/MADATA00_0	Pushbutton UP
3	PA1/RTO21_0/TIOA9_0/BIN2_0/MADATA01_0	Pushbutton RIGHT
4	PA2/RTO22_0/TIOA10_0/ZIN2_0/MADATA02_0	Pushbutton CENTER
5	PA3/RTO23_0/TIOA11_0/MADATA03_0	Pushbutton LEFT
6	PA4/RTO24_0/TIOA12_0/MADATA04_0	Pushbutton DOWN
7	PA5/SIN1_0/RTO25_0/TIOA13_0/INT01_0/MADATA05_0	Pushbutton IRQ
8	PA6/SOT1_0/DTTI2X_0/MADATA06_0	
9	PA7/SCK1_0/IC20_0/MADATA07_0	
10	P50/SCS72_0/RTO00_1/TIOA8_2/MADATA16_0	Motor0/MFT0
11	P51/SCS73_0/RTO01_1/TIOB8_2/MADATA17_0	Motor0/MFT0
12	P52/RTO02_1/TIOA9_2/MADATA18_0	Motor0/MFT0
13	P53/RTO03_1/TIOB9_2/MADATA19_0	Motor0/MFT0
14	PA8/SIN7_0/IC21_0/INT02_0/WKUP1/MADATA08_0	Ethernet PHY IRQ
15	PA9/SOT7_0/IC22_0/MADATA09_0	
16	PAA/SCK7_0/IC23_0/MADATA10_0	USB (Host1 VBUS enable)
17	PAB/SCS70_0/RX0_0/FRCK2_0/INT03_0/MADATA11_0	USB1 Overcurrent IRQ
18	PAC/SCS71_0/TX0_0/TIOB8_0/AIN3_0/MADATA12_0	Motor0/QPRC3
19	P54/SIN15_1/RTO04_1/TIOA10_2/INT00_2/MADATA20_0	Motor0/MFT0
20	P55/SOT15_1/RTO05_1/TIOB10_2/MADATA21_0	Motor0/MFT0
21	P56/SCK15_1/DTTIOX_1/TIOB0_1/MADATA22_0	Motor0/MFT0
22	P57/IC00_1/TIOB1_1/MADATA23_0	Motor0/IC0
23	PAD/SCK3_0/TIOB9_0/BIN3_0/MADATA13_0	Motor0/QPRC3
24	PAE/ADTG_0/SOT3_0/TIOB10_0/ZIN3_0/MADATA14_0	Motor0/QPRC3

## Pin-List FM4-216-ETHERNET (2/9)

Pin	Function	Description
25	PAF/SIN3_0/TIOB11_0/INT16_0/MADATA15_0	
26	P58/SIN11_1/IC01_1/TIOB2_1/INT02_2/MADATA24_0	Motor0/IC0
27	P59/SOT11_1/IC02_1/TIOB3_1/MADATA25_0	Motor0/IC0
28	P5A/SCK11_1/IC03_1/TIOB4_1/MADATA26_0	
29	P5B/FRCK0_1/TIOB5_1/MADATA27_0	
30	P08/SIN14_0/TIOB12_0/INT17_0/MDQM0_0	
31	P09/SOT14_0/TIOB13_0/INT18_0/MDQM1_0	
32	P0A/ADTG_1/SCK14_0/AIN2_1/MCLKOUT_0	
33	P5C/TIOA11_2/MADATA28_0/RTCCO_1/SUBOUT_1	Motor0 OPT1 (Brake)
34	P30/RX0_1/TIOA13_2/INT03_2/MDQM2_0/I2SDI_0	I2S serial receive data input pin
35	P31/TX0_1/TIOB13_2/MDQM3_0/I2SCK_0	I2S bit clock terminal
36	P32/BIN2_1/INT19_0/S_DATA1_0	SD I/F
37	P33/FRCK0_0/ZIN2_1/S_DATA0_0	SD I/F
38	P34/IC03_0/INT00_1/S_CLK_0	SD I/F
39	<b>VCC</b>	MCUVCC
40	<b>VSS</b>	GND
41	P35/IC02_0/INT01_1/S_CMD_0	SD I/F
42	P36/IC01_0/INT02_1/S_DATA3_0	SD I/F
43	P37/IC00_0/INT03_1/S_DATA2_0	SD I/F
44	P38/ADTG_2/DTTIOX_0/S_WP_0	SD I/F
45	P39/SIN2_1/RTO00_0/TIOA0_1/AIN3_1/INT16_1/S_CD_0/MAD24_0	SD I/F
46	P3A/SOT2_1/RTO01_0/TIOA1_1/BIN3_1/INT17_1/MAD23_0	
47	P3B/SCK2_1/RTO02_0/TIOA2_1/ZIN3_1/INT18_1/MAD22_0/MNALE_0	
48	P3C/SIN13_0/RTO03_0/TIOA3_1/INT19_1/MAD21_0/MNCLE_0	

## Pin-List FM4-216-ETHERNET (3/9)

Pin	Function	Description
49	P3D/SOT13_0/RTO04_0/TIOA4_1/MAD20_0/MNWEX_0	
50	P3E/SCK13_0/RTO05_0/TIOA5_1/MAD19_0/MNREX_0	
51	P5D/SIN10_1/TIOB11_2/INT01_2/MADATA29_0/I2SMCLK_0	I2S External clock terminal
52	P5E/SOT10_1/TIOA12_2/MADATA30_0/I2SDO_0	I2S serial transmit data output pin
53	P5F/SCK10_1/TIOB12_2/MADATA31_0/I2SWS_0	I2S frame sync signal terminal
54	<b>VSS</b>	GND
55	<b>VCC</b>	MCUVCC
56	P40/SIN3_1/RTO10_0/TIOA0_0/AINO_0/INT23_0/MCSX7_0	TFT Connector (CSYNC)
57	P41/SOT3_1/RTO11_0/TIOA1_0/BINO_0/MCSX6_0	TFT Connector (DE)
58	P42/SCK3_1/RTO12_0/TIOA2_0/ZINO_0/MCSX5_0	TFT Connector (DCLK)
59	P43/SIN15_0/RTO13_0/TIOA3_0/INT04_0/MCSX4_0	TFT Connector (VSYNC)
60	P44/SOT15_0/RTO14_0/TIOA4_0/MCSX3_0	TFT Connector (HSYNC)
61	P45/SCK15_0/RTO15_0/TIOA5_0/MCSX2_0	TFT Connector (LEDCTRL)
62	<b>C</b>	C
63	<b>VSS</b>	GND
64	<b>VCC</b>	MCUVCC
65	P4A/SIN12_1/AINO_1/INT04_2	CAN FD control SPI
66	P4B/SOT12_1/BINO_1	CAN FD control SPI
67	P4C/SCK12_1/ZINO_1	CAN FD control SPI
68	P4D/SCS72_1/RX2_2/INT05_2	CAN2 (CAN-FD)
69	P4E/SCS73_1/TX2_2	CAN2 (CAN-FD)
70	<b>P7D/SCK1_1/RX2_0/DTTI1X_0/INT05_0/WKUP2/MCSX1_0</b>	CAN FD Wake
71	<b>P7E/ADTG_7/TX2_0/FRCK1_0/MCSX0_0</b>	CAN FD control SPI
72	<b>INITX</b>	Reset

## Pin-List FM4-216-ETHERNET (4/9)

Pin	Function	Description
73	P46/ <b>X0A</b>	[Crystal (Subclock)]
74	P47/ <b>X1A</b>	[Crystal (Subclock)]
75	<b>VBAT</b>	VBAT
76	P48/VREGCTL	
77	P49/VWAKEUP	
78	PF0/SCS63_0/RX2_1/FRCK1_1/TIOA15_1/INT22_1	
79	PF1/SCS62_0/TX2_1/TIOB15_1/INT23_1	
80	P70/ADTG_8/SIN1_1/INT06_0/MRDY_0/CECO_0	
81	P71/SOT1_1/MAD00_0	
82	P72/SIN9_0/TIOB0_0/INT07_0/MAD01_0	
83	P73/SOT9_0/TIOB1_0/MAD02_0	
84	P74/SCK9_0/TIOB2_0/MAD03_0	
85	PF2/RTO10_1/TIOA6_1/MRASX_0	
86	PF3/RTO11_1/TIOB6_1/INT05_1/MCASX_0	
87	PF4/RTO12_1/TIOA7_1/INT06_1/MSDWEX_0	
88	<b>PF5</b> /RTO13_1/TIOB7_1/INT07_1/MCSX8_0	Multicon0 Reset
89	PF6/RTO14_1/TIOA14_1/ <b>INT20_1</b> /MSDCKE_0	Multicon0 (GINT)
90	PF7/RTO15_1/TIOB14_1/ <b>INT21_1</b> /MSDCLK_0	Multicon0 (TINT)
91	P75/ <b>SIN8_0</b> /TIOB3_0/AIN1_0/INT20_0/MAD04_0	Multicon0
92	P76/ <b>SOT8_0</b> /TIOB4_0/BIN1_0/MAD05_0	Multicon0
93	P77/ <b>SCK8_0</b> /TIOB5_0/ZIN1_0/MAD06_0	Multicon0
94	PF8/SCS70_1/DTTI1X_1/AIN1_1	
95	PF9/SCS71_1/IC10_1/BIN1_1	
96	P78/SIN6_0/IC10_0/INT21_0/MAD07_0	

## Pin-List FM4-216-ETHERNET (5/9)

Pin	Function	Description
97	P79/SOT6_0/IC11_0/MAD08_0	
98	P7A/SCK6_0/IC12_0/MAD09_0	
99	P7B/DA1/SCS60_0/IC13_0/INT22_0	---
100	P7C/DA0/SCS61_0/INT04_1	---
101	PFA/SCK7_1/IC11_1/ZIN1_1	
102	PFB/SOT7_1/IC12_1/INT07_2	
103	PFC/SIN7_1/IC13_1/INT06_2	
104	PE0/ <b>MD1</b>	MD1
105	<b>MD0</b>	MD0/ USB Direct Flash
106	PE2/ <b>X0</b>	Crystal (mainclock)
107	PE3/ <b>X1</b>	Crystal (mainclock)
108	<b>VSS</b>	GND
109	<b>VCC</b>	MCUVCC
110	<b>AVCC</b>	AVCC
111	<b>AVSS</b>	AVSS
112	<b>AVRL</b>	AVRL
113	<b>AVRH</b>	AVRH
114	P10/ <b>AN00</b> /SIN10_0/TIOA0_2/AINO_2/INT08_0	Motor0/ADC
115	P11/ <b>AN01</b> /SOT10_0/TIOB0_2/BINO_2	Motor0/ADC
116	P12/ <b>AN02</b> /SCK10_0/TIOA1_2/ZINO_2	Motor0/ADC
117	P13/ <b>AN03</b> /SIN6_1/RX1_1/INT25_1	Motor0/ADC
118	P14/ <b>AN04</b> /SOT6_1/TX1_1	Motor0/ADC
119	<b>PB8</b> /ADTG_6/SCS63_1/INT08_2/TRACED8	TFT Connector
120	<b>PB9</b> /SIN9_1/AIN2_2/INT09_2/TRACED9	TFT Connector



## Pin-List FM4-216-ETHERNET (6/9)

Pin	Function	Description
121	<b>PBA/SOT9_1/BIN2_2/TRACED10</b>	TFT Connector
122	<b>PBB/SCK9_1/ZIN2_2/TRACED11</b>	TFT Connector
123	P15/ <b>AN05/SIN11_0/TIOB1_2/AIN1_2/INT09_0</b>	Motor0/ADC
124	P16/ <b>AN06/SOT11_0/TIOA2_2/BIN1_2</b>	Motor0/ADC
125	P17/ <b>AN07/SCK11_0/TIOB2_2/ZIN1_2</b>	Motor0/ADC
126	<b>PB0/AN16/SCK6_1/TIOA9_1</b>	TFT Connector
127	<b>PB1/AN17/SCS60_1/TIOB9_1/INT08_1</b>	TFT Connector
128	<b>PB2/AN18/SCS61_1/TIOA10_1/INT09_1</b>	TFT Connector
129	<b>PB3/AN19/SCS62_1/TIOB10_1</b>	TFT Connector
130	P18/ <b>AN08/SIN2_0/TIOA3_2/INT10_0</b>	Motor0/ADC
131	P19/ <b>AN09/SOT2_0/TIOB3_2/INT24_1/TRACECLK</b>	TRACE
132	P1A/ <b>AN10/SCK2_0/TIOA4_2/TRACED0</b>	TRACE
133	P1B/ <b>AN11/SIN12_0/TIOB4_2/INT11_0/TRACED1</b>	TRACE
134	P1C/ <b>AN12/SOT12_0/TIOA5_2/TRACED2</b>	TRACE
135	P1D/ <b>AN13/SCK12_0/TIOB5_2/TRACED3</b>	TRACE
136	<b>VSS</b>	GND
137	<b>VCC</b>	MCUVCC
138	<b>PB4/AN20/SIN8_1/TIOA11_1/INT10_1/TRACED4</b>	TFT Connector
139	<b>PB5/AN21/SOT8_1/TIOB11_1/INT11_1/TRACED5</b>	TFT Connector
140	<b>PB6/AN22/SCK8_1/TIOA12_1/TRACED6</b>	TFT Connector
141	<b>PB7/AN23/TIOB12_1/TRACED7</b>	TFT Connector
142	P1E/ <b>AN14/TIOA8_1/INT26_1/MAD10_0</b>	Variable Resistor RP1
143	P1F/ <b>AN15/RTS5_0/TIOB8_1/INT27_1/MAD11_0</b>	
144	P2A/ <b>AN24/CTS5_0/MAD12_0</b>	Software Touch

## Pin-List FM4-216-ETHERNET (7/9)

Pin	Function	Description
145	P29/ <b>AN25</b> /SCK5_0/MAD13_0	Software Touch
146	P28/ <b>AN26</b> /SOT5_0/MAD14_0	Software Touch
147	P27/ <b>AN27</b> /SIN5_0/INT24_0/MAD15_0	Software Touch
148	<b>PBC</b> /TX1_2/TRACED12	TFT Connector
149	<b>PBD</b> /SCK0_1/RX1_2/AIN3_2/INT10_2/TRACED13	TFT Connector
150	<b>PBE</b> /SOT0_1/BIN3_2/TRACED14	TFT Connector
151	<b>PBF</b> /SINO_1/ZIN3_2/INT11_2/TRACED15	TFT Connector
152	P26/ <b>TX1_0</b> /MAD16_0	CAN1
153	P25/ <b>AN28</b> / <b>RX1_0</b> /INT25_0/MAD17_0	CAN1
154	P24/ <b>AN29</b> / <b>TIOA13_1</b> /MAD18_0	LCD Illumination Dimming
155	<b>P23</b> /UHCONX1/ <b>AN30</b> /SCK0_0/TIOB13_1	LCD Reset
156	P22/ <b>AN31</b> / <b>SOT0_0</b> /INT26_0	UART/(USB-serial)
157	P21/ <b>ADTG_4</b> / <b>SINO_0</b> /INT27_0/CROUT_0	UART/(USB-serial)
158	P20/NMIX/WKUP0	---
159	<b>USBVCC1</b>	USBVCC1
160	P82/ <b>UDM1</b>	USB
161	P83/ <b>UDP1</b>	USB
162	<b>VSS</b>	GND
163	<b>VCC</b>	MCUVCC
164	P00/ <b>TRSTX</b>	JTAG
165	P01/ <b>TCK</b> /SWCLK	JTAG
166	P02/ <b>TDI</b>	JTAG
167	P03/ <b>TMS</b> /SWDIO	JTAG
168	P04/ <b>TDO</b> /SWO	JTAG

## Pin-List FM4-216-ETHERNET (8/9)

Pin	Function	Description
169	P90/INT12_1/Q_IO3_0	QSPI Memory
170	P91/SIN5_1/INT13_1/Q_IO2_0	QSPI Memory
171	P92/SOT5_1/INT14_1/Q_IO1_0	QSPI Memory
172	P93/SCK5_1/INT15_1/Q_IO0_0	QSPI Memory
173	P94/CTS5_1/Q_SCK_0	QSPI Memory
174	P95/RTS5_1/Q_CS0_0	QSPI Memory
175	P96/RX0_2/INT12_2/Q_CS1_0	CAN0
176	P97/TX0_2/INT13_2/Q_CS2_0	CAN0
177	PC0/E_RXER	Ethernet
178	PC1/TIOB6_0/E_RX03	Ethernet
179	PC2/TIOA6_0/E_RX02	Ethernet
180	PC3/TIOB7_0/E_RX01	Ethernet
181	PC4/TIOA7_0/E_RX00	Ethernet
182	PC5/TIOB14_0/E_RXDV	Ethernet
183	PC6/TIOA14_0/E_MDIO	Ethernet
184	PC7/INT13_0/E_MDC/CROUT_1	Ethernet
185	PC8/E_RXCK_REFCK	Ethernet
186	PC9/TIOB15_0/E_COL	Ethernet
187	PCA/TIOA15_0/E_CRS	Ethernet
188	ETHVCC	Ethernet
189	VSS	GND
190	PCB/INT28_0/E_COUT	Ethernet Clock Out Option

## Pin-List FM4-216-ETHERNET (9/9)

Pin	Function	Description
193	PCE/SIN4_1/INT15_0/E_TX03	Ethernet
194	PCF/RTS4_1/INT12_0/E_TX02	Ethernet
195	PD0/INT30_1/E_TX01	Ethernet
196	PD1/INT31_1/E_TX00	Ethernet
197	PD2/CTS4_1/FRCK2_1/E_TXEN	Ethernet
198	P6E/ADTG_5/SCK4_1/IC23_1/INT29_0/E_PPS	Yellow LED on Ethernet connector
199	P6D/SCK14_1/IC22_1/TIOB6_2	HMI SCL
200	P6C/SOT14_1/IC21_1/TIOA6_2	HMI SDA
201	P6B/SIN14_1/IC20_1/TIOB7_2/INT14_2	USB0 Overcurrent IRQ
202	P6A/DTTI2X_1/TIOA7_2	Ethernet PHY Reset
203	P69/RTO20_1/TIOB14_2	Multicon1 Reset
204	P68/SCK13_1/RTO21_1/TIOA14_2	Multicon1
205	P67/SOT13_1/RTO22_1/TIOB15_2	Multicon1
206	P66/SIN13_1/RTO23_1/TIOA15_2/INT15_2	Multicon1
207	P65/RTO24_1/INT28_1	Multicon1 (GINT)
208	P64/CTS4_0/RTO25_1/INT29_1	Multicon1 (TINT)
209	P63/ADTG_3/RTS4_0/INT30_0/MOEX_0	USB (Host/Device Switch)
210	P62/SCK4_0/MWEX_0	USB (Host0 VBUS enable)
211	P61/UHCONX0/SOT4_0/MALE_0/RTCCO_0/SUBOUT_0	USB
212	P60/SIN4_0/INT31_0/WKUP3/CEC1_0	USB Direct Flash / DEVICE_VBUS
213	USBVCC0	USBVCC0
214	P80/UDM0	USB

- The assembled CAN FD transceiver is specified only up to 2 Mbits/sec whereas the FM4's hardware supports up to 5 Mbits/sec
  - If a specified 5 Mbits/sec transceiver for CAN FD (CAN2) is needed, the 8 pin device TJA1044 can be soldered into the 14 pin footprint of the 2 Mbits/sec TJA1145
  - Small software modification necessary
    - ✓ Configure pin P7E as GPIO output
    - ✓ Drive pin P7E low
- On a production lot with Spansion branding following errors on the silkplot have been found:
  - JP5 is labeled USB PROG but must be UART PROG
  - The naming labels of RN14 and RN15 near the SD card connector are swapped, there is no electrical problem though
  - Both errors are rectified on all boards with Cypress branding



# Software

- Software examples for IAR EWARM V6.60 or KEIL  $\mu$ Vision5.1:  
See <drive:>\Examples\ or [www.cypress.com](http://www.cypress.com)
  - s6e2cc\_template-v14.zip
    - ✓ ,Empty' project as base for user applications
  - s6e2cc\_ethernet\_driver-v16.zip
    - ✓ Cypress low-level Ethernet driver
  - And several more

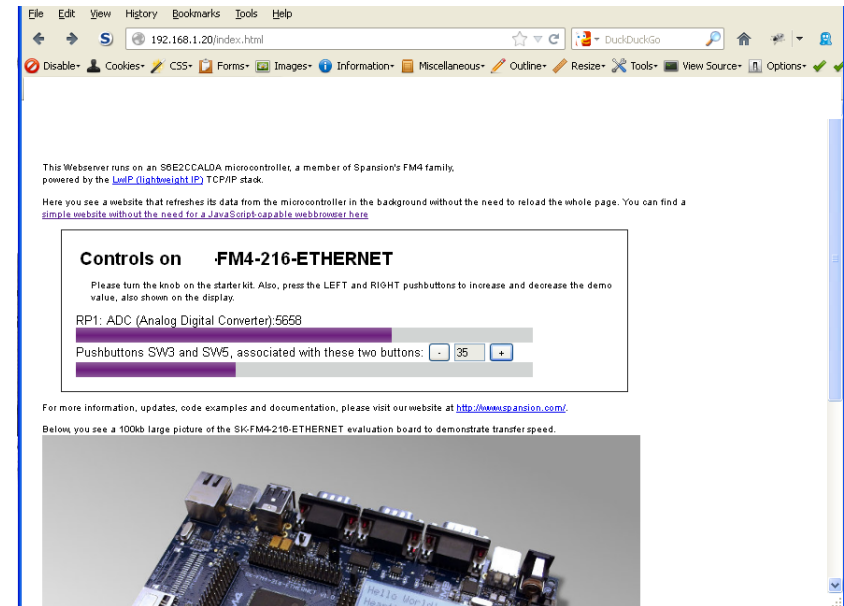

**Note: Please copy the examples to your local drive before compiling!**

You can find product information of the commercially supported TCP/IP stack by [SEVENSTAX on this CD](#).

- The following software tools are available
  - USB Virtual-COM port
    - ✓ allows UART communication via the PC's USB connection
    - ✓ On-board UART-to-USB converter (via X2, CMSIS-DAP)
    - ✓ For driver installation <drive:>\drivers\driverinstaller.exe
  - FLASH USB DIRECT Programmer
    - ✓ Microcontroller Flash programming (via X12, USB-Device-Port)
    - ✓ Install from <drive:>\tools\USBDIRECT
  - Terminal program ,Serial Port Viewer'
    - ✓ Install from <drive:>\tools\serialportviewer\setup.exe





# Flash Programming

- There are several options to program the microcontroller's flash:
  - FLASH USB DIRECT Programmer via X12 (USB device)
    - ✓ For installation <drive:>\tools\USBDIRECT\setup.exe
    - ✓ USB driver is located in subdirectory of FLASH USB DIRECT Programmer
  - FLASH MCU Programmer via X2 (Serial via DEBUG USB/Serial bridge)
    - ✓ For installation <drive:>\tools\PCWFM3-V01L07\setup.exe
    - ✓ For driver installation of USB/Virtual-COM port  
<drive:>\drivers\driverinstaller.exe
  - JTAG Programming via X2 (CMSIS-DAP)
    - ✓ Example is given for IAR and KEIL
    - ✓ See documentation of your development suite how to setup CMSIS-DAP
  - JTAG Programming via J14 (optional JTAG adapter)
    - ✓ The correct JTAG-adapter must be selected in the IDE toolchain

## ■ FLASH USB DIRECT Programming via X12 (USB device)

### • Jumper Setting

- ✓ Select the MCU power supply (JP75, 76, 77)
- ✓ Open JP5 (USB PROG)
- ✓ Set switch S1 to position PGM

### • Connect USB port X12 with the PC

### • If connected for first time Windows OS may ask for a driver

- ✓ See subfolder ,driver' of USBdirect installation path  
or use <drive:>\drivers\driverinstaller.exe

### • Start the FLASH USB DIRECT Programmer

- ✓ For first installation: <drive:>\Utilities\USBDIRECT\setup.exe
- ✓ Select the COM port
- ✓ Press Reset
- ✓ Start Full Operation
- ✓ Set switch S1 to position RUN
- ✓ Press Reset

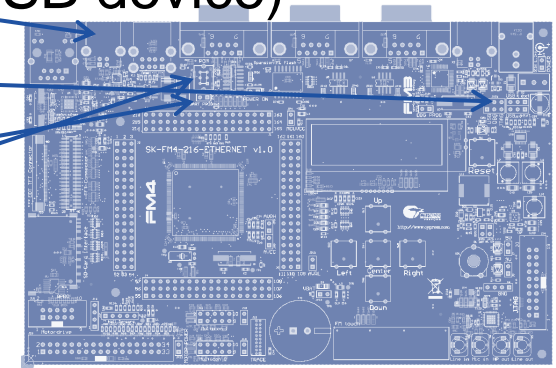

- Select the correct target MCU: S6E2CCAH0A/J0A/L0A
- Browse for the programming file (\*.srec or \*.hex)
  - IAR: see subfolder <project>\example\IAR\output\release\exe
  - ARM/KEIL: see subfolder <project>\example\ARM\output\release
- Adjust the corresponding virtual COM-port

Select MCU: S6E2CCAH0A/J0A/L0A

Select file (\*.srec; \*.hex)

Select Virtual COM-port



- Use 'Full Operation'
  - Download kernel
  - Erase Flash memory / Blank check
  - Program & Verify project to Flash memory
- Set switch S1 to position RUN and press Reset button

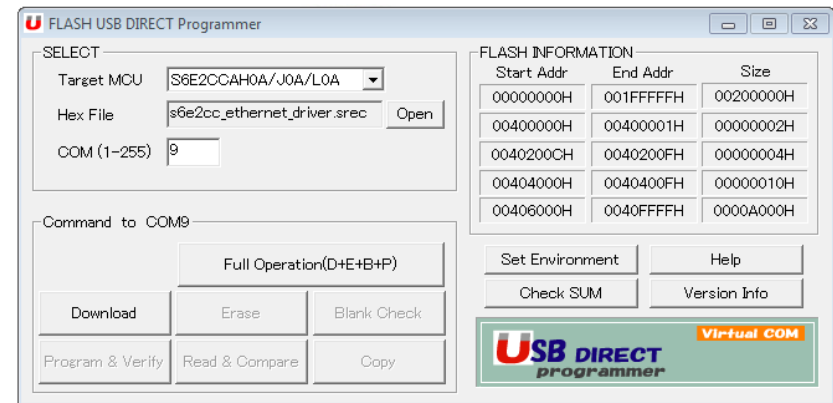

# Flash Programming via X2 (Serial)

## ■ FLASH MCU Programming via X2 (DEBUG)

### • Jumper Setting

- ✓ Select the MCU power supply (JP75, 76, 77)
- ✓ Close JP5
- ✓ Set switch S1 to position PGM

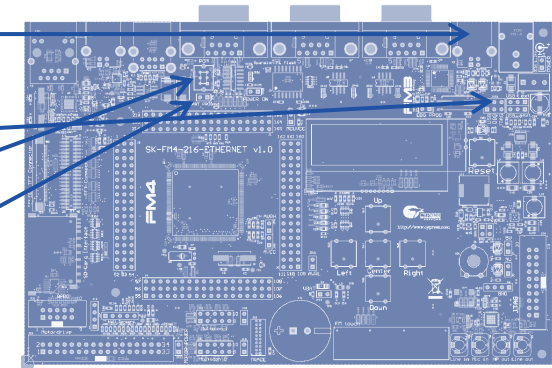

### • Connect the board via USB CMSIS-DAP (X2) to the USB-Port of the PC

- ✓ When connected for first time Windows OS may ask for  
,cypressbvcomm.inf“  
<drive:>\drivers\cmsis-dap

### • Use the FLASH MCU Programmer for FM3/FM4

- ✓ For installation <drive:>\tools\PCWFM3-V01L07\setup.exe

# Flash Programming via X2 (Serial)

- Select the correct target MCU: S6E2CCA0A/J0A/L0A
- Select 4MHz Crystal Frequency
- Browse for the programming file (\*.srec or \*.hex)
  - IAR: see subfolder <project>\example\IAR\output\release\exe
  - ARM/KEIL: see subfolder <project>\example\ARM\output\release
- Adjust the corresponding virtual COM-port

Select MCU: S6E2CCA0A/J0A/L0A

Select 4MHz Crystal Frequency

Select file (\*.srec / \*.hex)

Select Virtual COM-port

Execute 'Full Operation'

incl. stand-alone operations

- Download Kernel

- Erase

- Blank Check

- Program&Verify

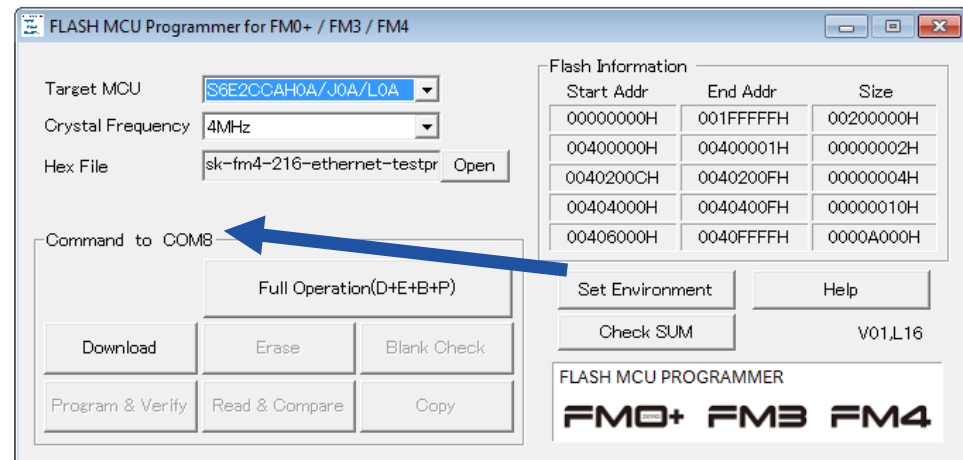

- Set switch S1 to position RUN and press Reset button



# JTAG Debugger

# JTAG adapter CMSIS-DAP

- This starterkit includes an on-board JTAG adapter
  - Compatible to CMSIS-DAP
    - [http://www.keil.com/support/man/docs/dapdebug/dapdebug\\_introduction.htm](http://www.keil.com/support/man/docs/dapdebug/dapdebug_introduction.htm)
  - Select debugger CMSIS-DAP in your tool chain
- Any other JTAG-adapter can be connected to J14, too.
  - The correct JTAG-adapter must be selected in the IDE toolchain
    - ✓ No jumper setting is required
- Additional virtual COM port is provided by X2 (DEBUG)
  - ✓ For driver installation <drive:>\drivers\driverinstaller.exe

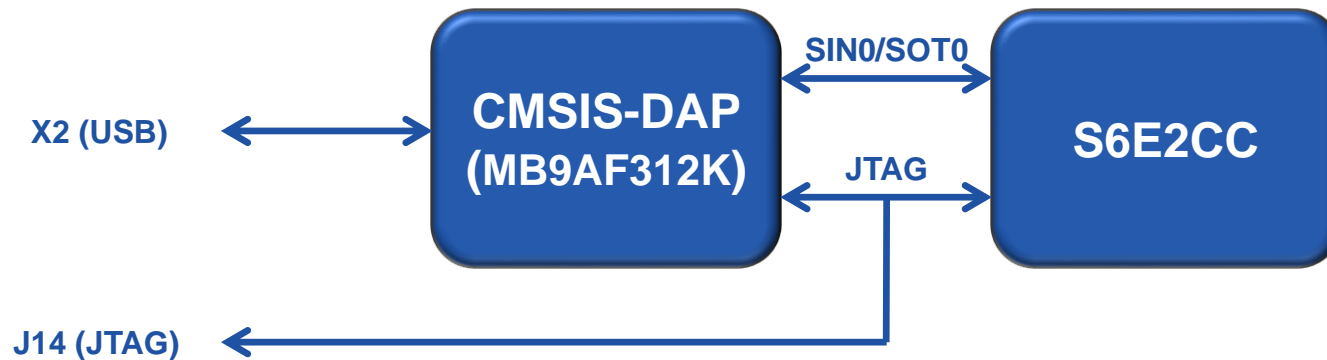



## Setup in IAR EWARM (1)

### Navigate to project options:

#### Via Files-List

- Right-click at the project
- Select „Options...“

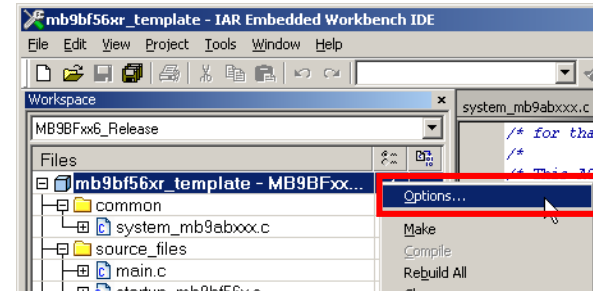

#### Or via menu „Project“

- Select „Options...“

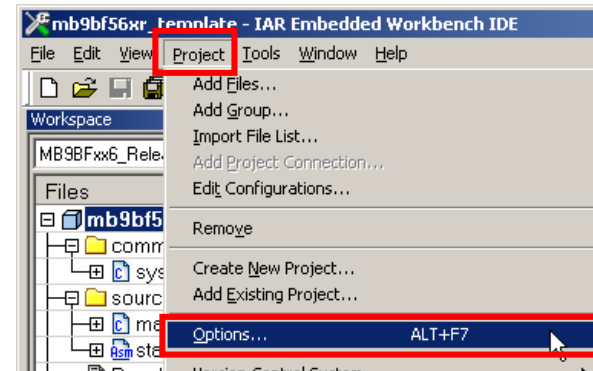

## Setup in IAR EWARM (2)

### Setup Project Debbuger Options

- (1) Navigate to Debugger
- (2) Select tab „Setup“
- (3) Select Driver „CMSIS-DAP“
- (4) Select in „CMSIS-DAP“
- (5) Select tab „JTAG/SWD“
- (6) Select SWD

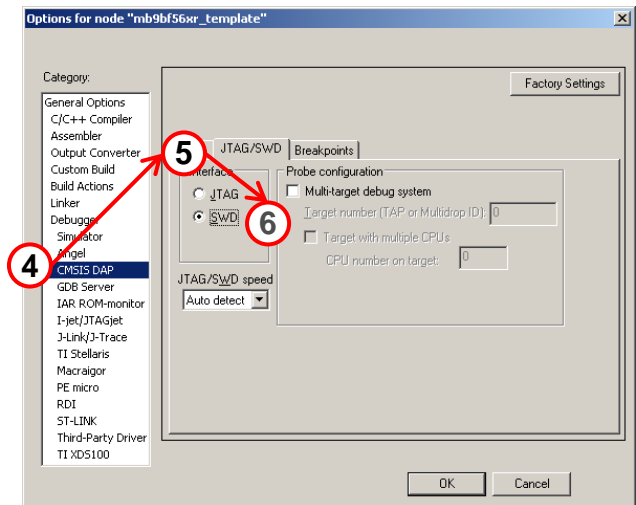
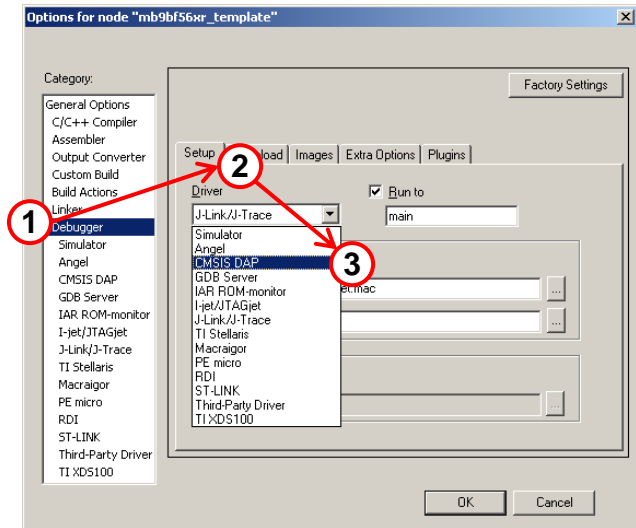

## Setup in Keil $\mu$ Vision (1)

### Navigate to project options:

#### Via Project

Right-click at the project  
Select „Options...“

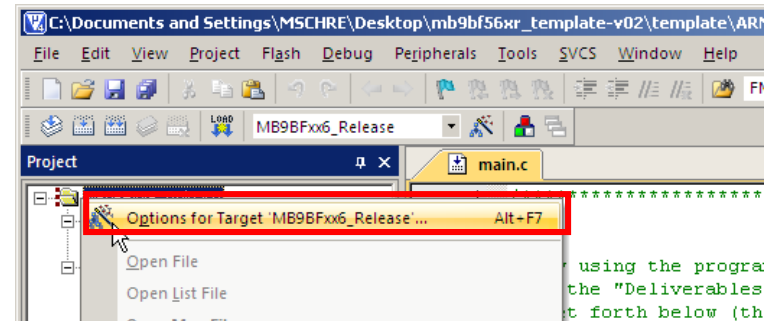

#### Or via menu „Project“

Select „Options...“

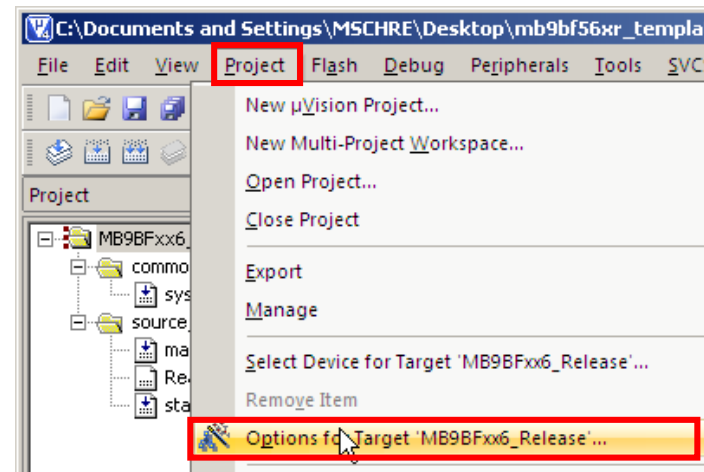

## Setup in Keil $\mu$ Vision (2)

### Setup Debug & Utilities

- (1) Select tab „Debug“
- (2) Select „CMSIS-DAP Debugger“
- (3) Select tab „Utilities“
- (4) Select „CMSIS-DAP Debugger“

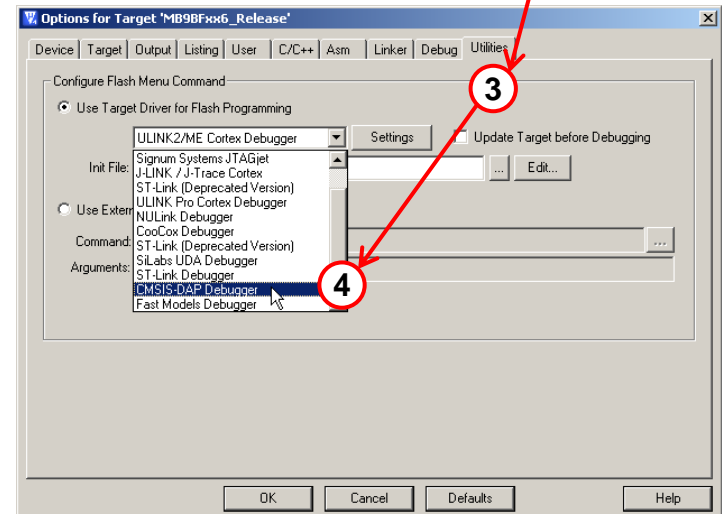
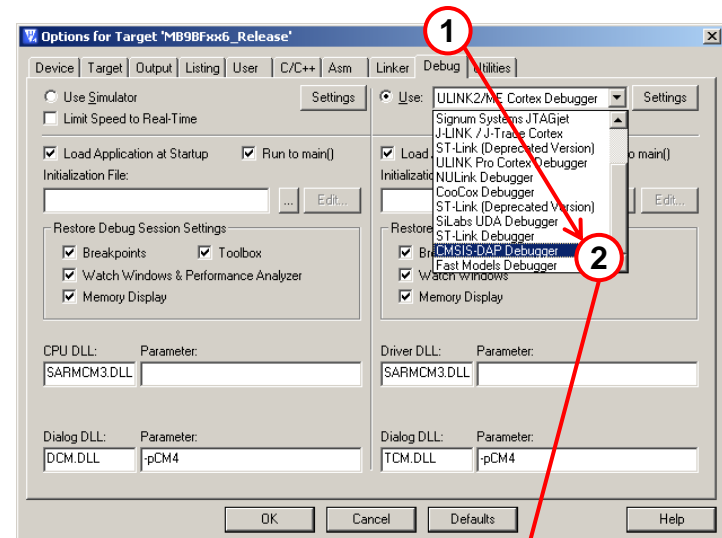

**Please see instructions contained in firmware update package!**

# IAR Embedded Workbench

**Installation**  
**Getting Started**  
**Open Project**  
**Build Project**  
**Debug Project**

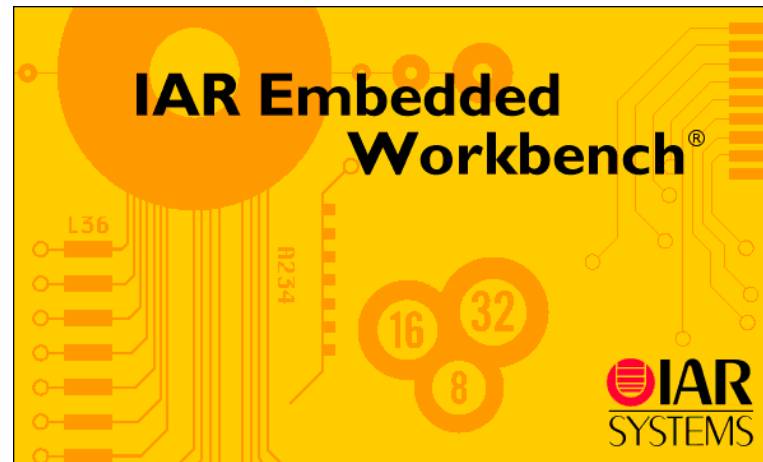

# IAR Workbench Getting Started

- Install EWARM from IAR-CD or download latest version from IAR Website
  - EWARM size-limited (32k) or time-limited (full) Evaluation Version
    - ✓ <http://supp.iar.com/Download/SW/?item=EWARM-EVAL>
- Start EWARM Workbench
- Choose File → Open → Workspace
  - e.g.: <drive>\sw-examples\



- IAR Workbench
  - Workspace on left side of Workbench window
    - ✓ If hidden then View → Workspace
  - Source files on right side of Workbench window as tabbed windows
  - Project open  
File → Open → Workspace → \*.eww
  - For new projects start with ,mb9bfd1xt\_template'

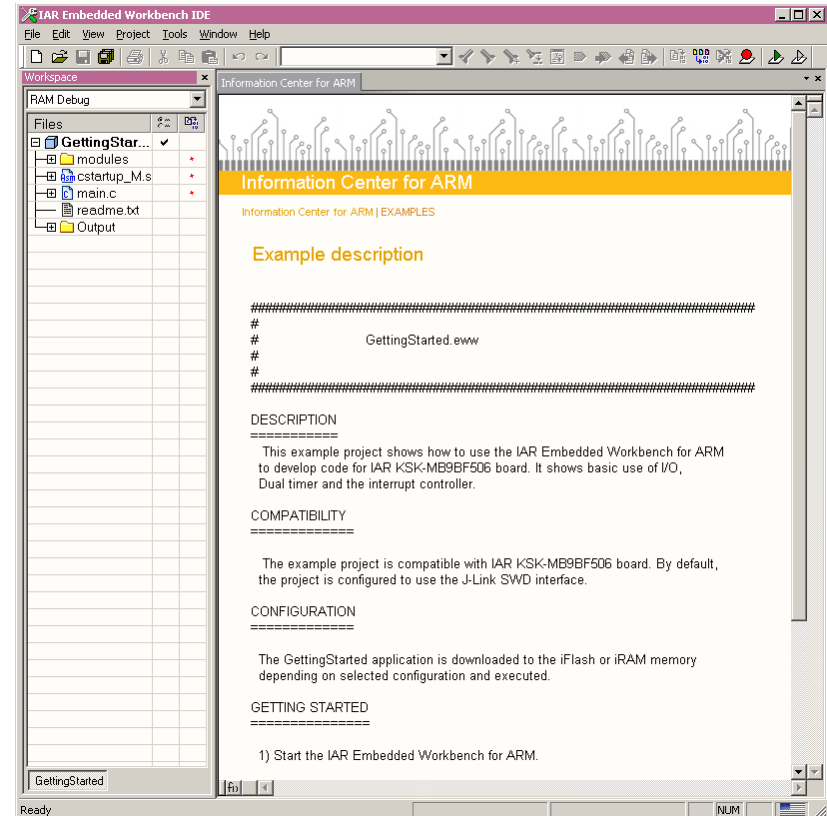





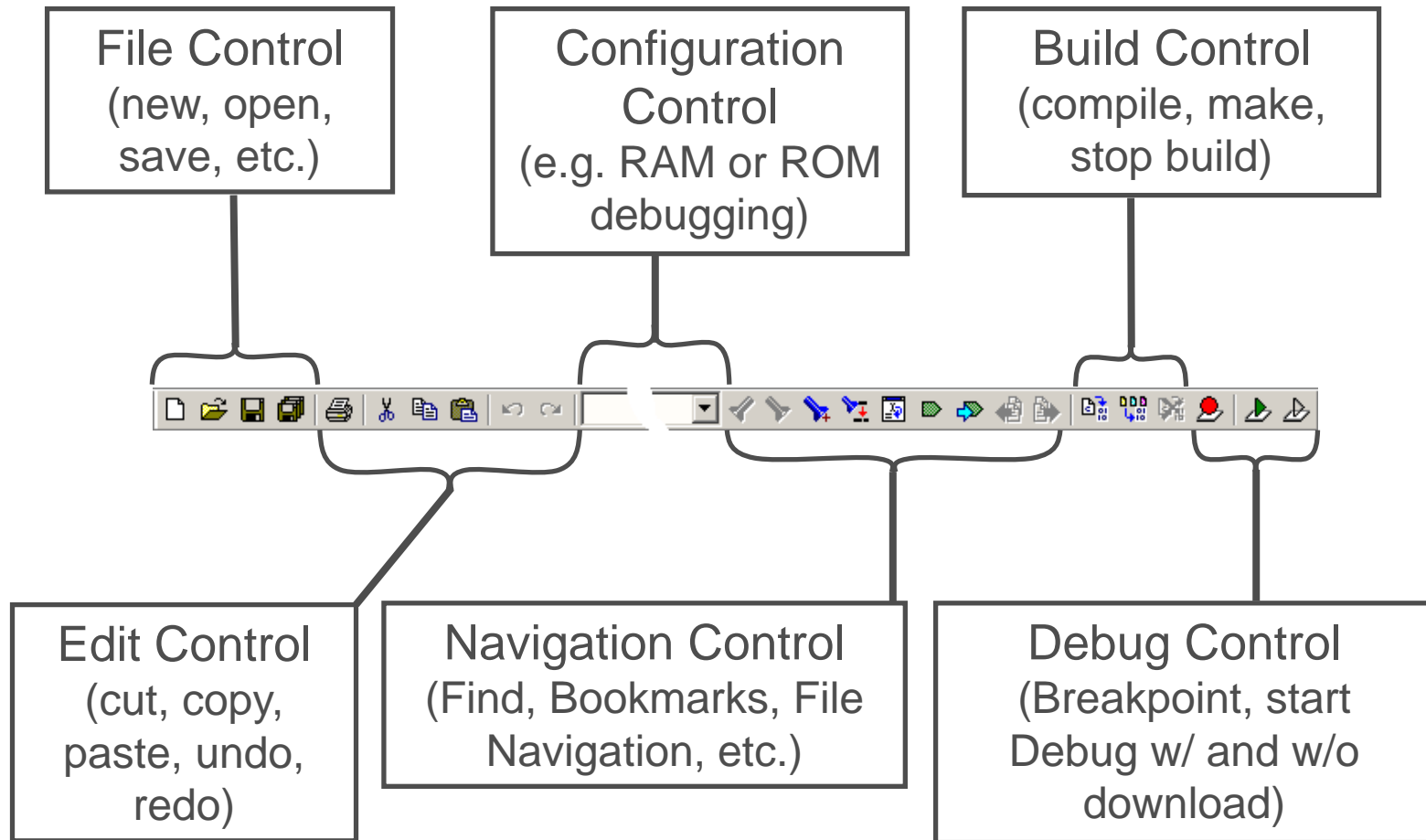

- IAR Menu Bar

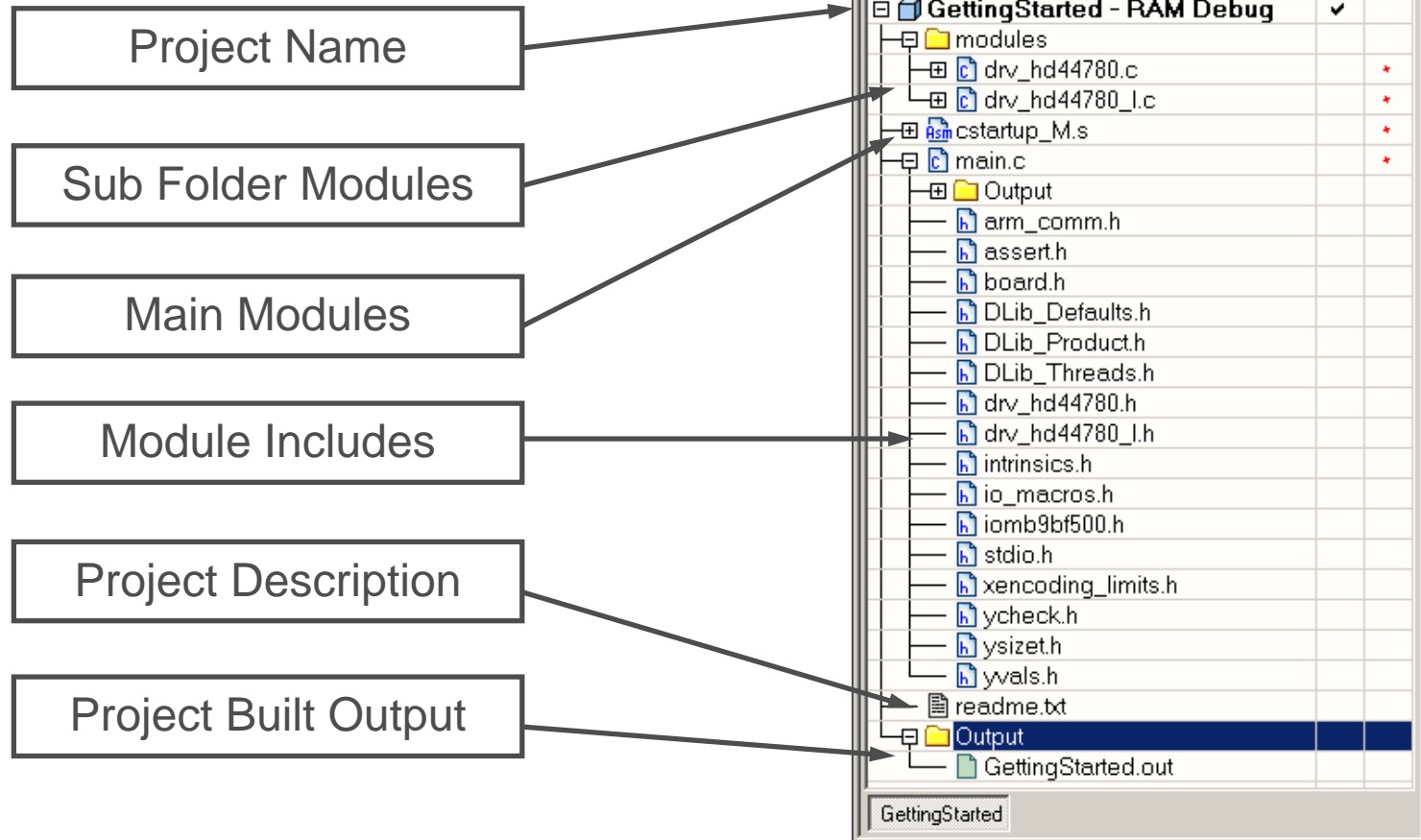



- IAR Workspace Window

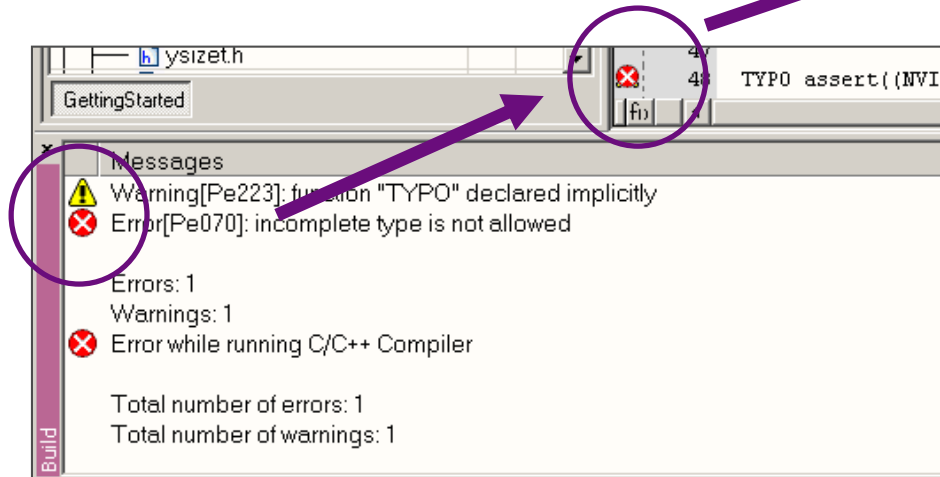
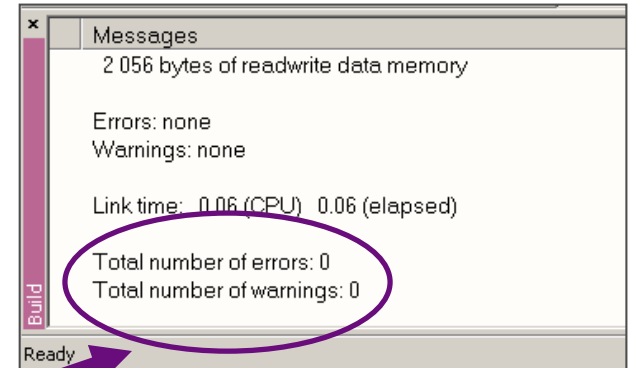

## ■ Making the Project

- Use Make-Icon (  ), <F7> or Menu: Project→Make
- Check for no errors in Output window below
- Build errors are indicated by  or  In Output window and Source view



- Download to Target and Start Debugging
  - Use  Icon, <Ctrl>-D, or Project→Download and Debug
  - A new menu bar will occur on successful connection to target

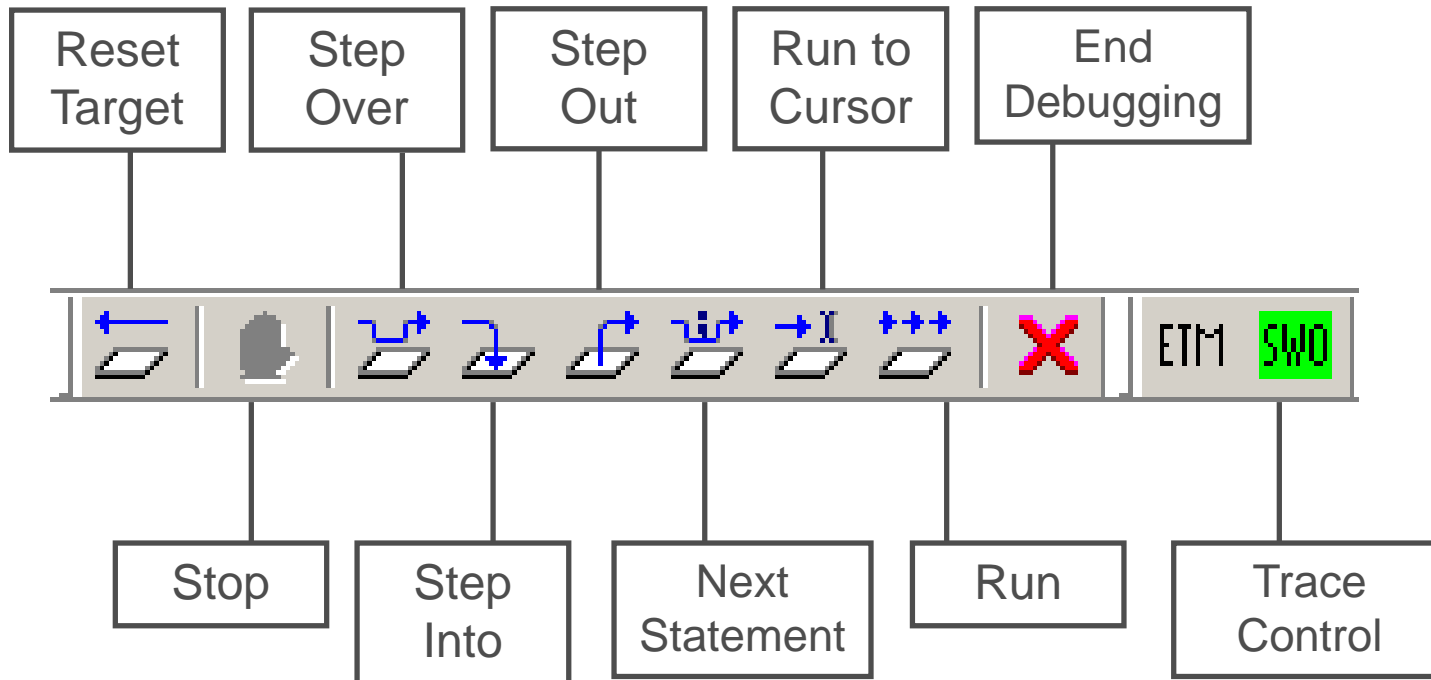

## ■ Source Window

- The Source windows do not change contents but get additional information

- ✓ Current line (PC):
- ✓ Halted on Breakpoint:
- ✓ Halted on Data break (example):

```
165 CSW_TMR_bit.MOWT = 9;  
172 PSW_TMR_bit.POWT = 2;  
148 Timer1IntClr = 1;
```

## ■ Disassembly Window

- Shows 'pure' disassembly view
- Shows mixed mode view

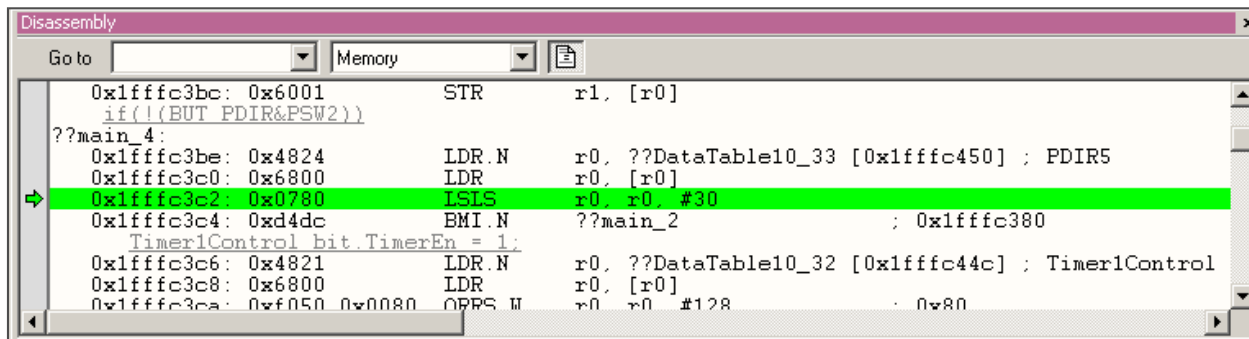

## ■ Watch Window

### • Watch

- ✓ Expressions/Variables have to be added by user and are updated by Halt/Breakpoint

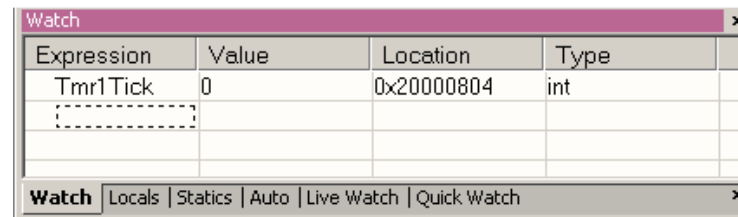

### • Quick Watch

- ✓ The Quick watch allows the user to calculate and recalculate expressions even with variables

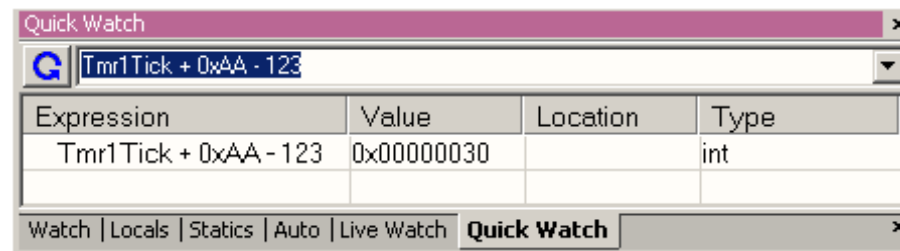

- ✓ The drop down menu memorizes the last typed contents

- Simulator
  - Mark Project File in Workspace
  - Choose Project→Options
  - Choose Simulator in Debugger Setup
  - Start Simulator with usual  Icon

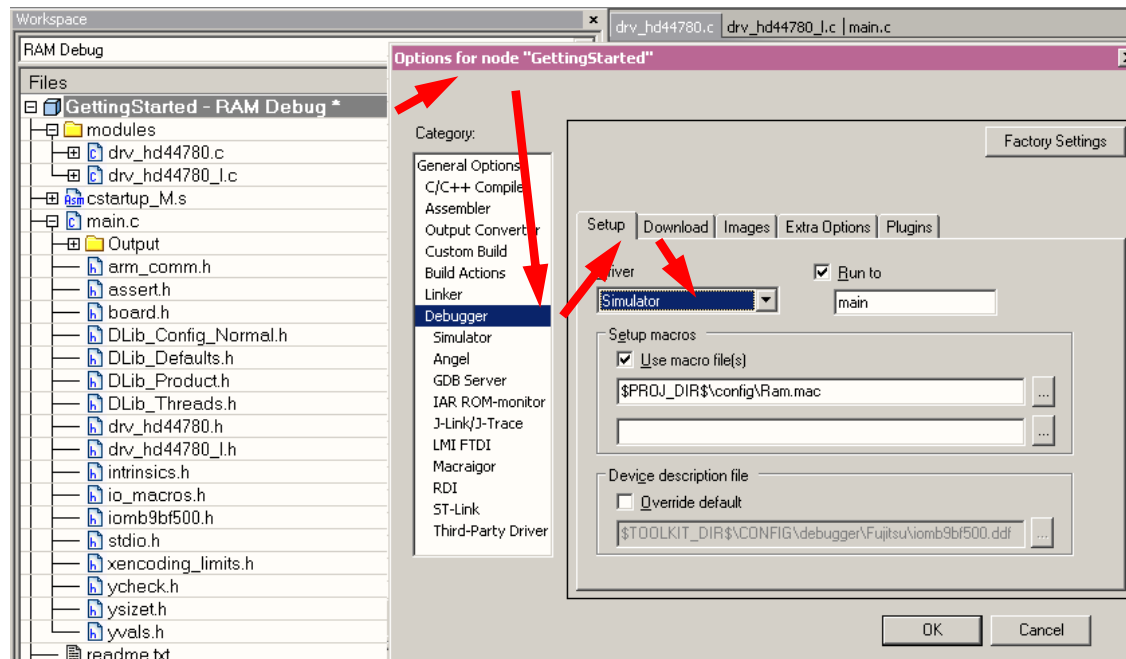

# KEIL $\mu$ Vision

**Installation**  
**Getting Started**  
**Open Project**  
**Build Project**  
**Debug Project**





- Install  $\mu$ Vision from KEIL-CD or download latest version from KEIL Website
  - Evaluation Version
    - ✓ <https://www.keil.com/demo/eval/arm.htm>
    - ✓ Registration required
- Install ULINK-ME
  - Special installation is not needed, because ULINK-ME acts as a USB Human Interface Device (HID) and thus needs no extra USB driver
- Install ULINK Pro (optional)
  - ULINK Pro needs an own dedicated USB driver located in:  
<Installation Path>\KEIL\ARM\ULINK
- Start  $\mu$ Vision

# KEIL $\mu$ Vision – Getting Started

- Choose Menu: Project→Open Project...
  - Browse to: <drive:>\sw-examples\mb9bf56xr\_gpio-v10\example\ARM\
  - Choose mb9bf56xr\_gpio.uvproj

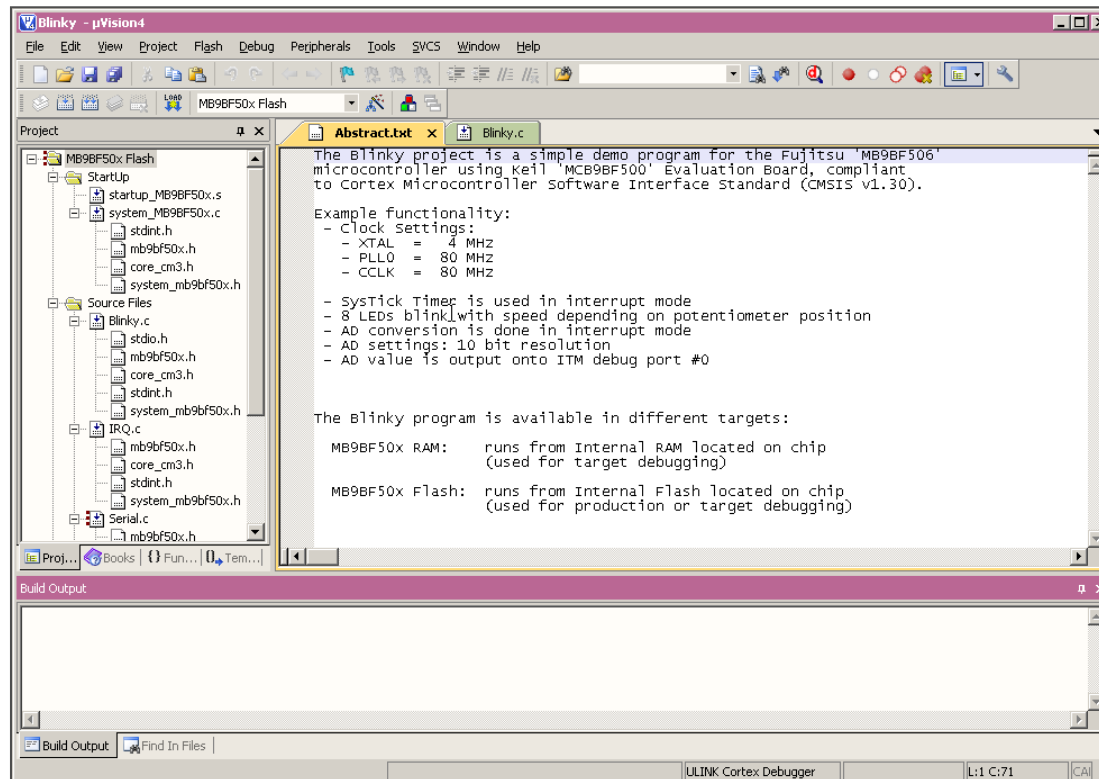

# KEIL $\mu$ Vision – Main Window

- KEIL  $\mu$ Vision
  - Project window on left side of IDE window
    - ✓ Choose:  
View  $\rightarrow$  Project Window  
if hidden
  - Source files on right side of IDE window as tabbed windows
  - Output window on bottom side of IDE window

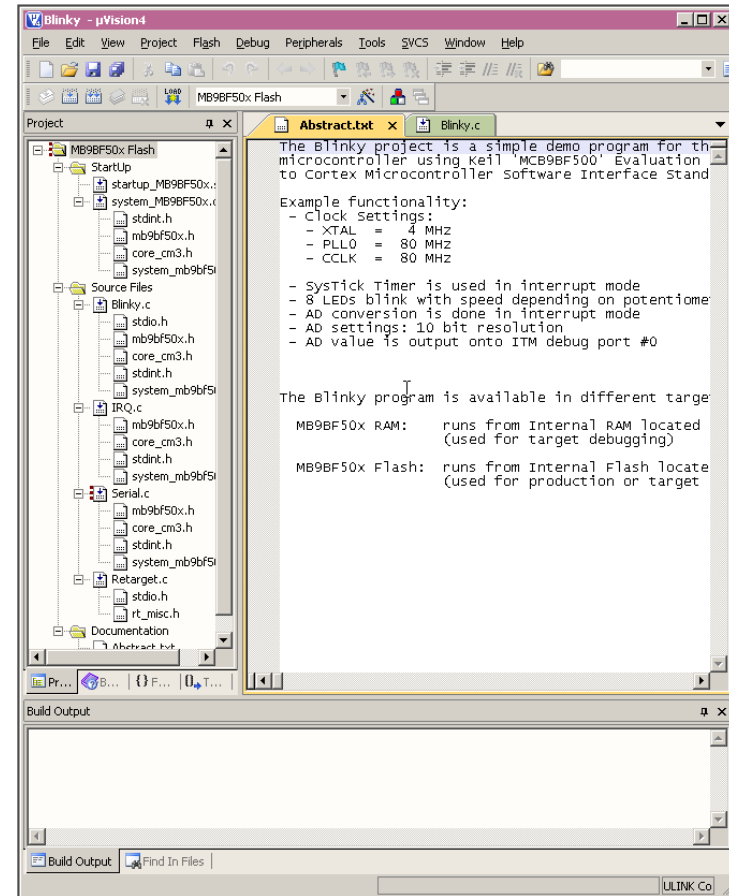

# KEIL $\mu$ Vision – Menu Bars (1)

- Menu Bar 1
  - Can be moved in bar window area or set floating

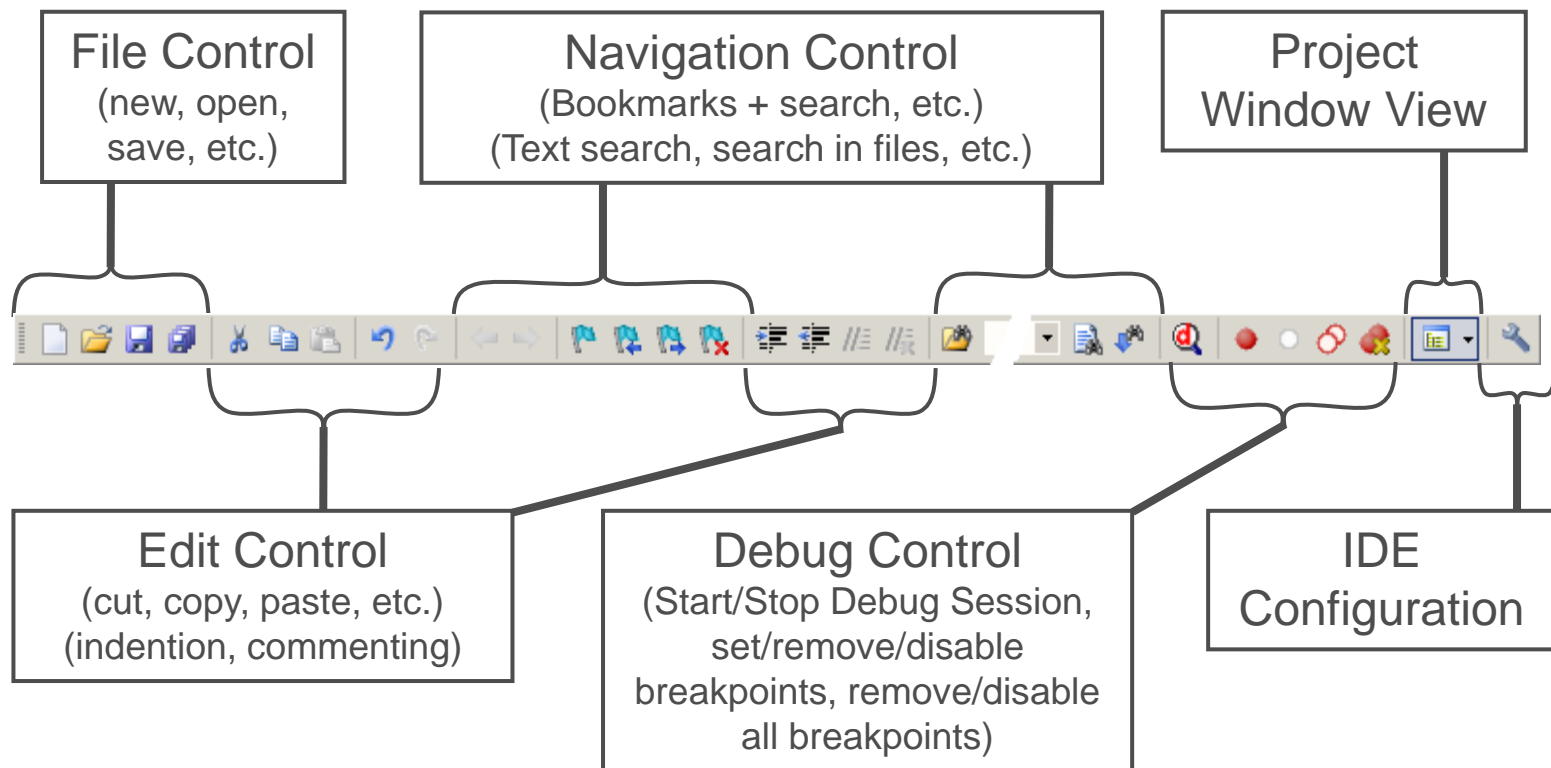

# KEIL $\mu$ Vision – Menu Bars (2)

- Menu Bar 2
  - Can be moved in bar window area or set floating

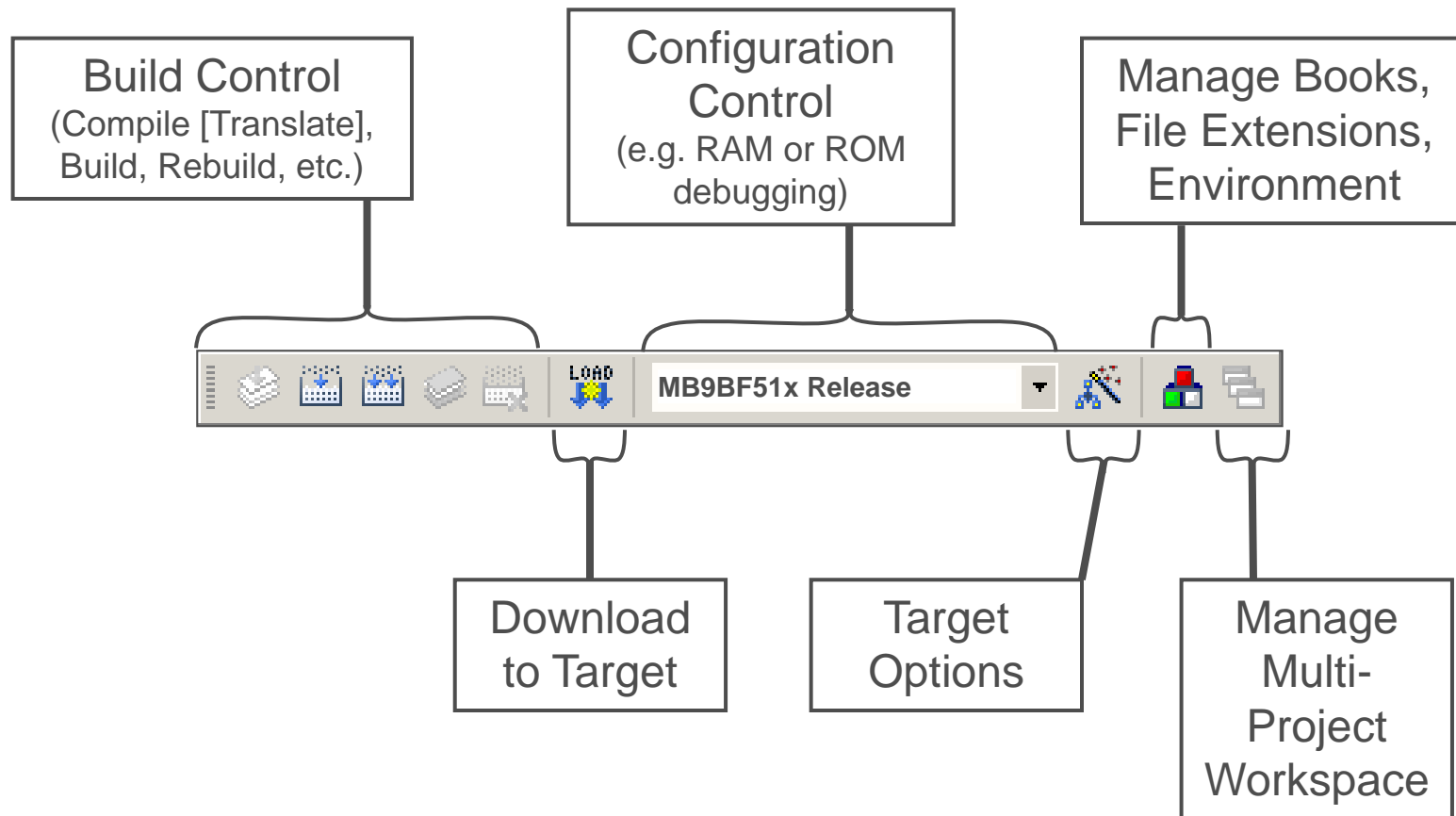

# KEIL $\mu$ Vision – Project Window

- $\mu$ Vision Project Window

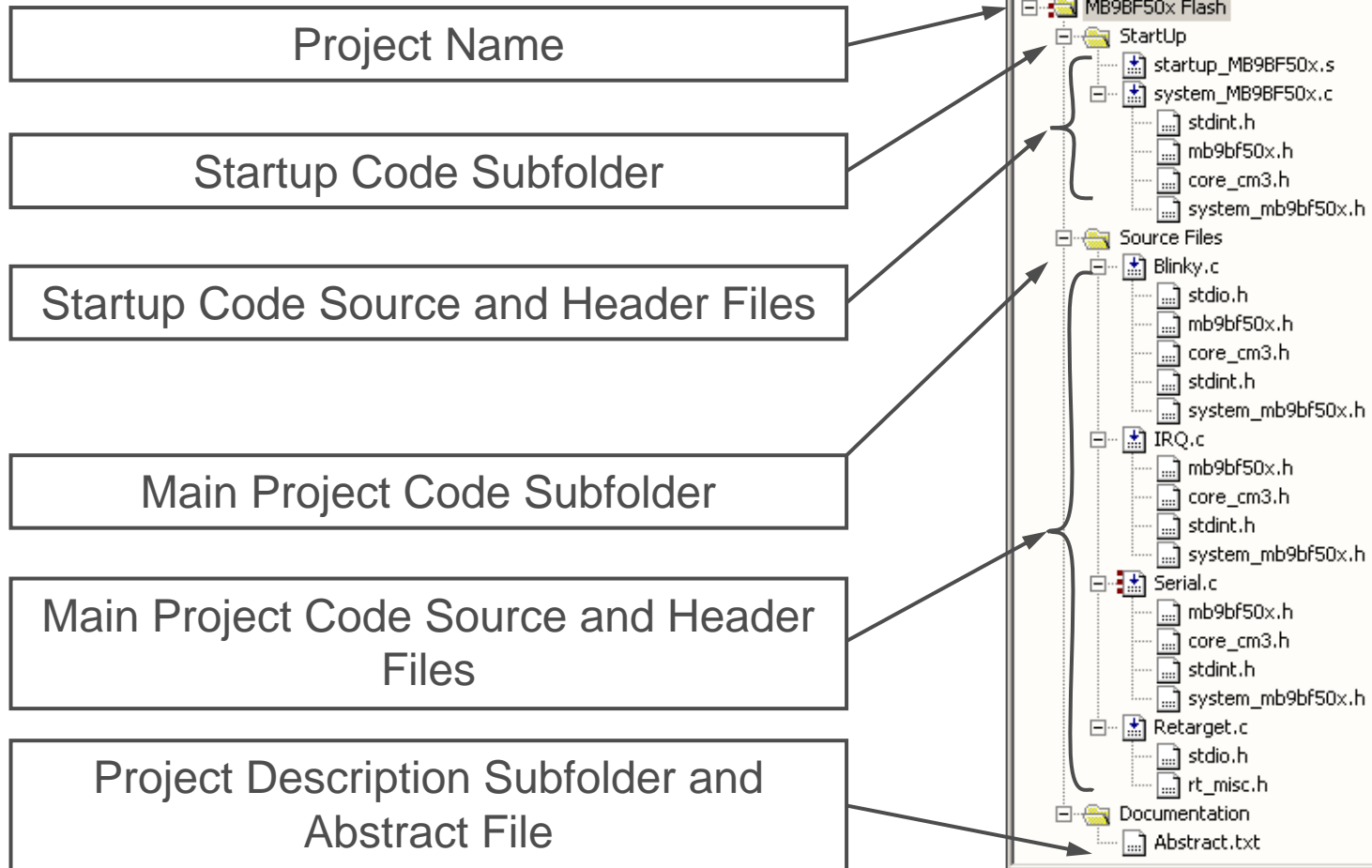

## ■ Making the Project

- Use Rebuild Icon



Project → Rebuild all target files

- Check for no errors in Output window below

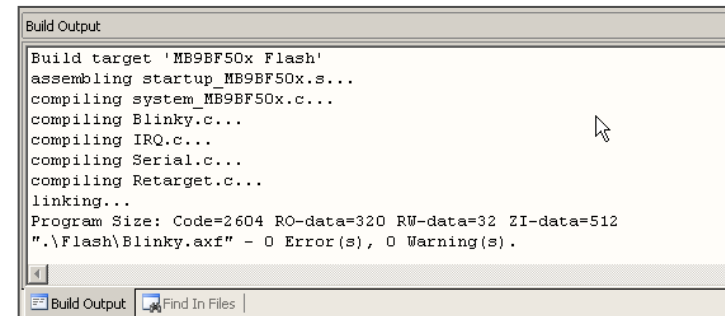

```
Build Output
Build target 'MB9BF50x Flash'
assembling startup_MB9BF50x.s...
compiling system_MB9BF50x.c...
compiling Blinky.c...
compiling IRQ.c...
compiling Serial.c...
compiling Retarget.c...
linking...
Program Size: Code=2604 RO-data=320 RW-data=32 ZI-data=512
".\Flash\Blinky.axf" - 0 Error(s), 0 Warning(s).
```

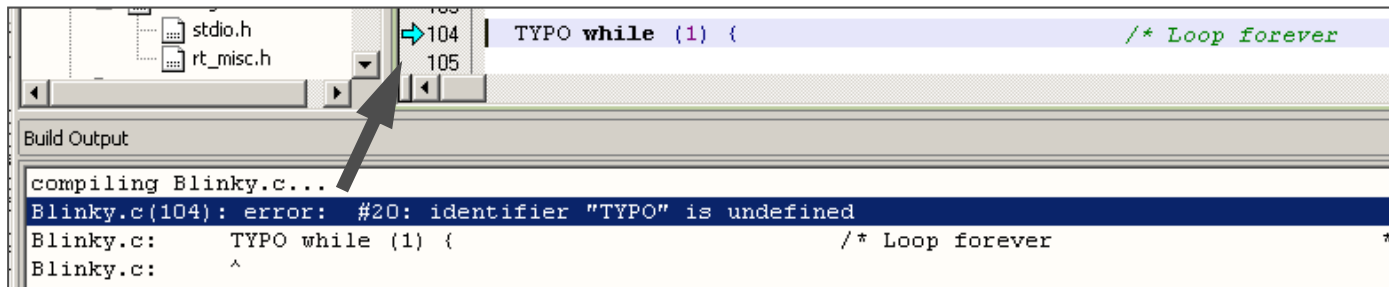

- Build errors are shown in Output window.

✓ Can be double-clicked by showing the source line with a blue arrow



```
stdio.h
rt_misc.h
104 | TYPO while (1) { /* Loop forever
105 |
Build Output
compiling Blinky.c...
Blinky.c(104): error: #20: identifier "TYPO" is undefined
Blinky.c: TYPO while (1) { /* Loop forever
Blinky.c: ^
```

## ■ Start Debugging

- Download to target first, when MCU Flash does not contain the current application openend and built in the IDE
  - ✓ Use Download Icon (  ) or Menu: Flash→Download
- Start Debug Session
  - ✓ Use Start/Stop Debug Icon (  ) or Menu: Debug→Start/Stop Debug Session
- Ending Debug Session
  - ✓ Use same way as for starting debug session



- Debugging Icon Bar

- During a Debug Session there will be visible a new icon bar

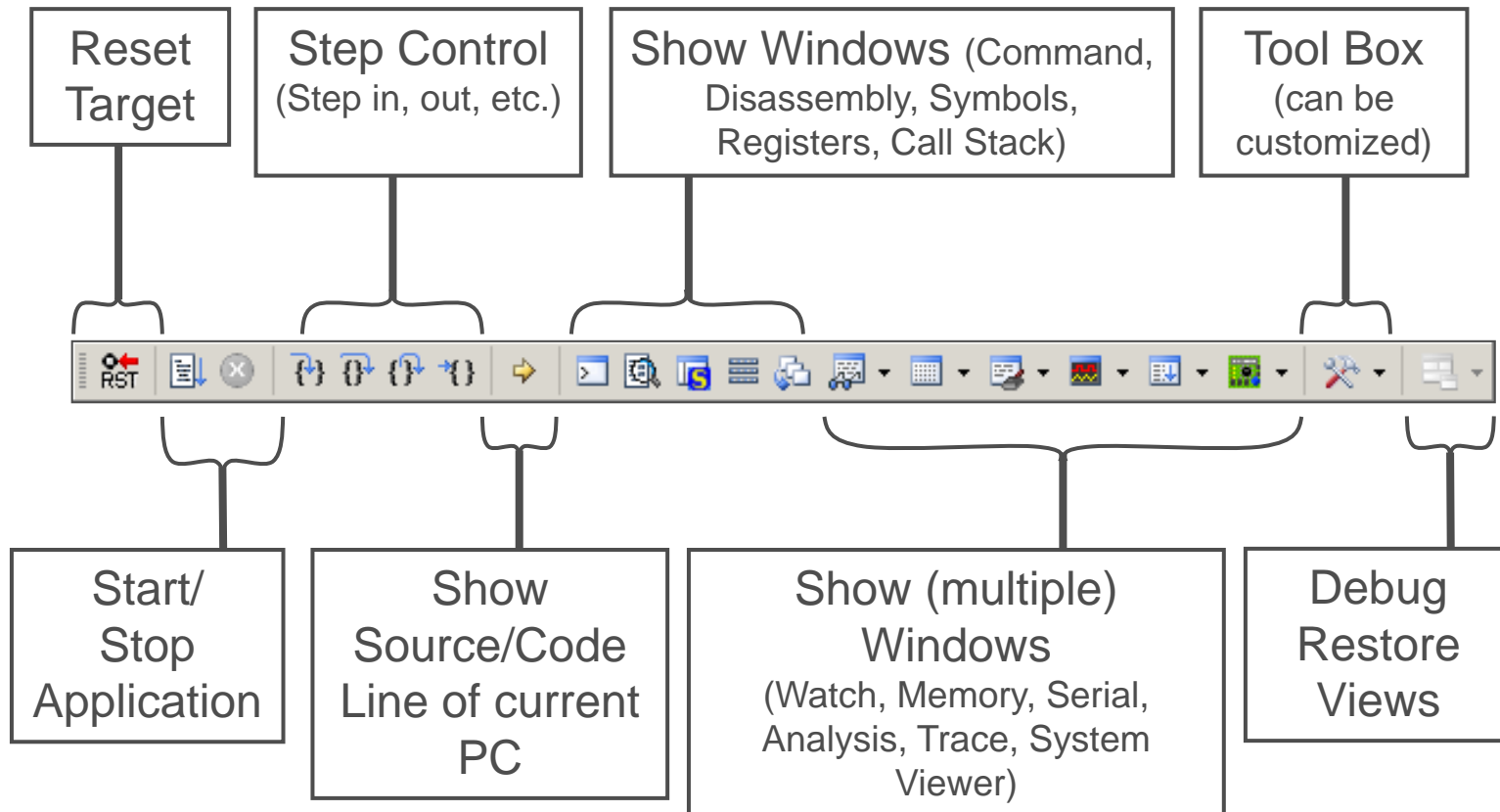

- Source View

- The Source windows do not change contents but get additional information

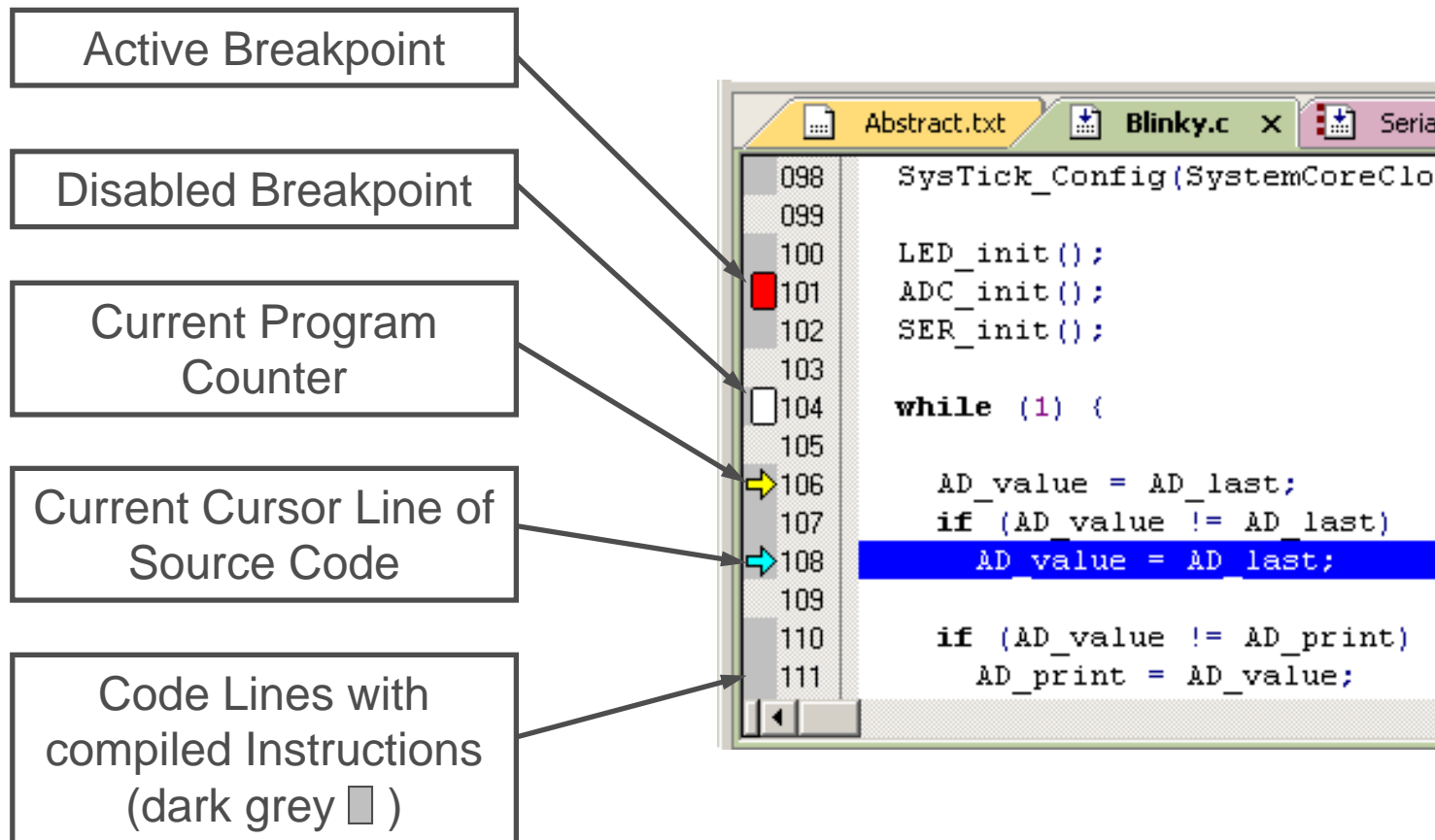

- Disassembly View
  - Mixed mode is selectable and deselectable

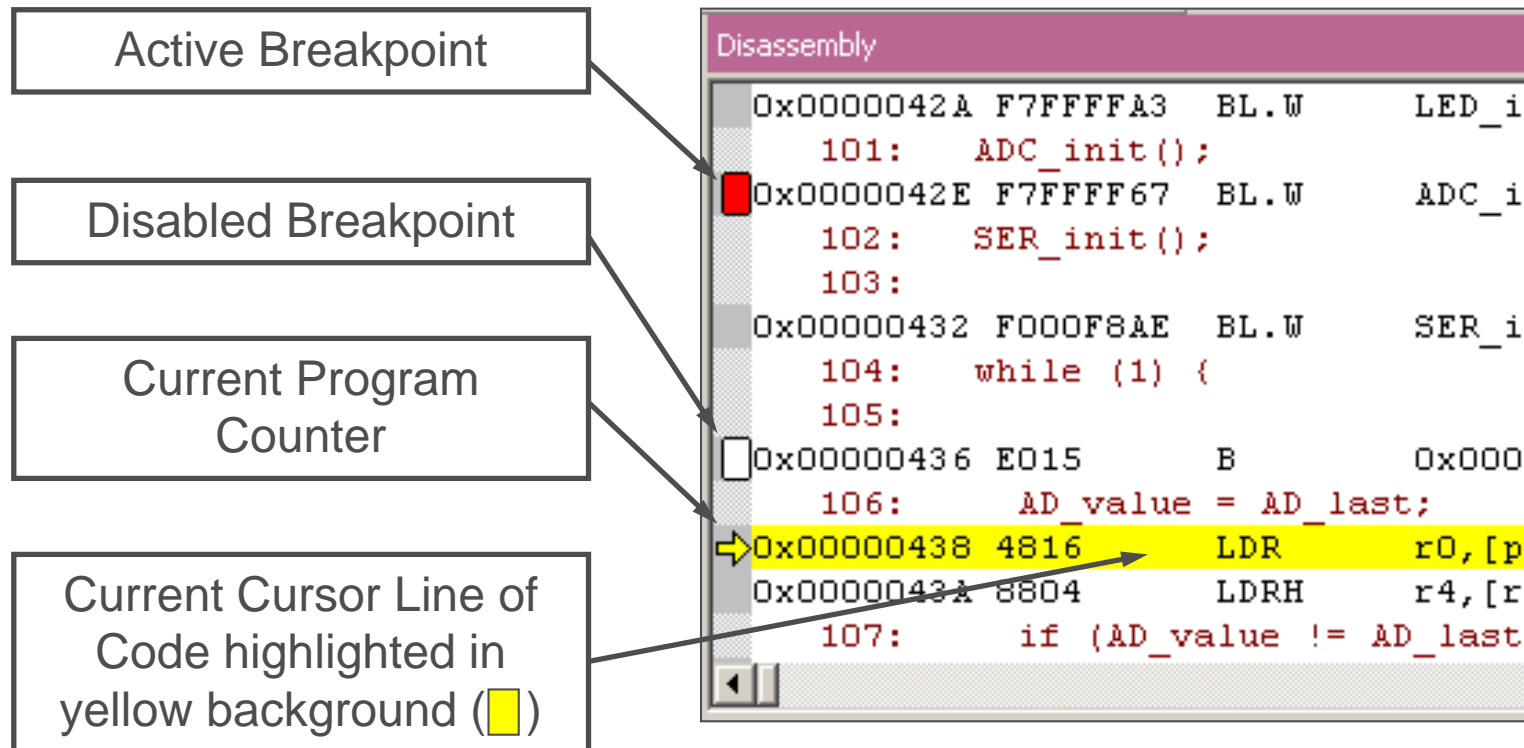

The screenshot shows the Disassembly window with the following code:

```
0x0000042A F7FFFA3 BL.W LED_i
101: ADC_init();
0x0000042E F7FFF67 BL.W ADC_i
102: SER_init();
103:
0x00000432 F000F8AE BL.W SER_i
104: while (1) {
105:
0x00000436 E015 B 0x0000
106: AD_value = AD_last;
0x00000438 4816 LDR r0, [p
0x0000043A 8804 LDRH r4, [r
107: if (AD_value != AD_last
```

Callouts from the left:

- Active Breakpoint: Points to the red square next to address 0x0000042E.
- Disabled Breakpoint: Points to the white square next to address 0x00000436.
- Current Program Counter: Points to the yellow arrow next to address 0x00000438.
- Current Cursor Line of Code highlighted in yellow background (■): Points to the line containing address 0x00000438.

- Memory Window
  - Up to 4 Memory windows can be displayed in tabs
  - Memory is updated during runtime
  - Memory window tabs are shared with Watch windows

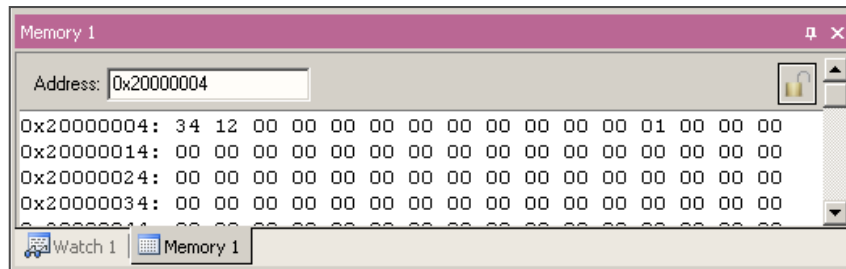

- Register View
  - Register view is a tab of the Project window
  - Changes are highlighted in dark blue text background
  - Register tree knots can be expanded

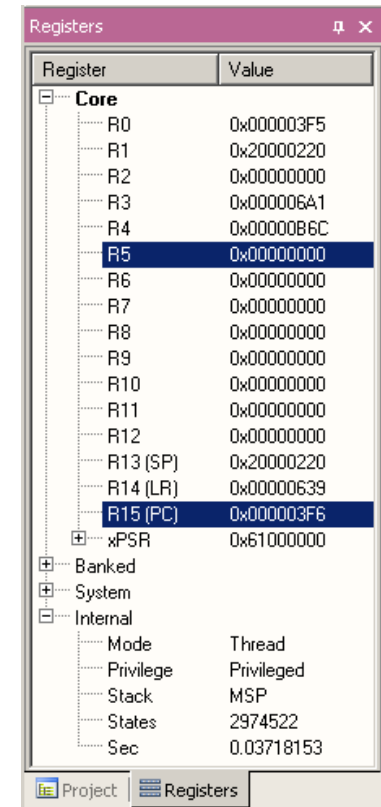

## ■ Variable Windows

### • Watch Windows

- ✓ Up to 2 Watch windows are sharing their tabs with e.g. Memory and Local views
- ✓ Updated during runtime
- ✓ Any changes are highlighted in dark blue text background color
- ✓ Displayed values can be changed by user during break

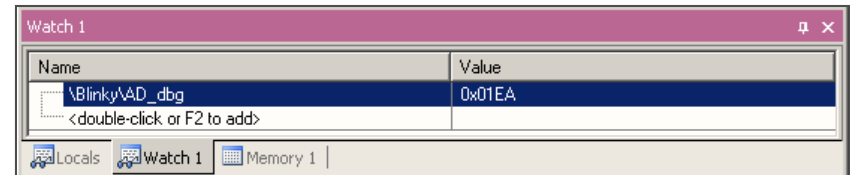

### • Local View

- ✓ The local view shares the tab with e.g. Memory and Watch windows
- ✓ Any changes are highlighted in dark blue text background color
- ✓ Displayed values can be changed by user during break

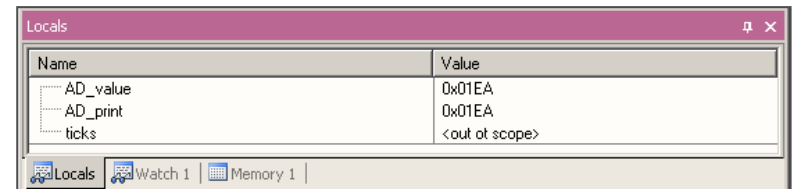

## Trace via ITM

- Simple Trace views via Instrumentation Trace Macro is supported by  $\mu$ LINK ME
  - ✓ Records
  - ✓ Exceptions
  - ✓ Counters

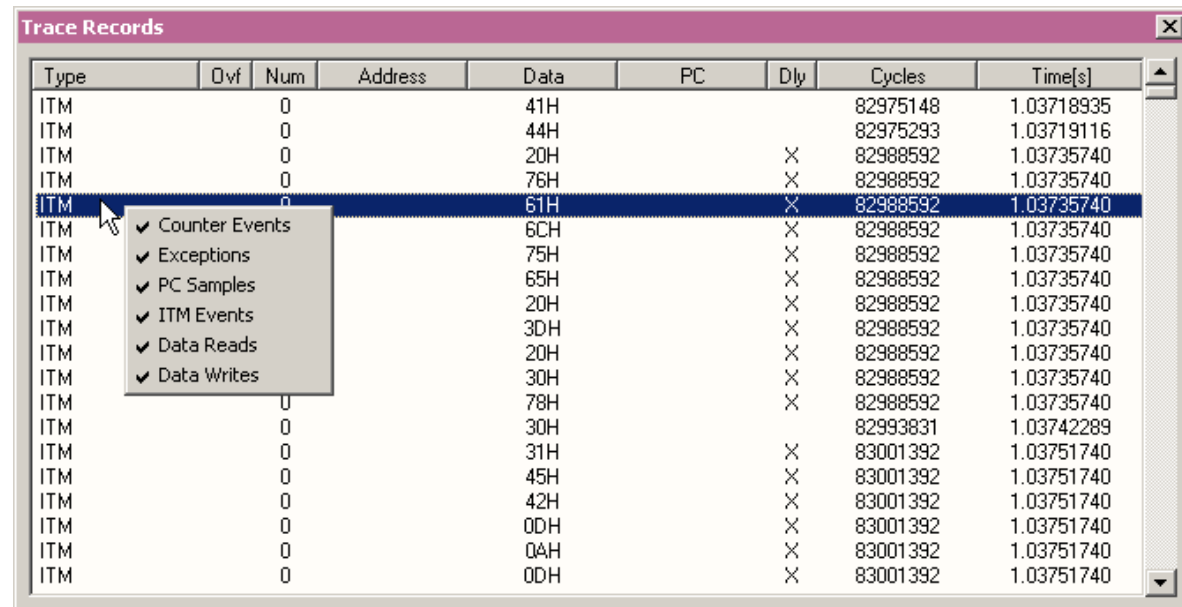

Type	Dly	Num	Address	Data	PC	Dly	Cycles	Time[s]
ITM		0	41H	41H			82975148	1.03718935
ITM		0	44H	44H			82975293	1.03719116
ITM		0	20H	20H		X	82988592	1.03735740
ITM		0	76H	76H		X	82988592	1.03735740
ITM		0	61H	61H		X	82988592	1.03735740
ITM		0	6CH	6CH		X	82988592	1.03735740
ITM		0	75H	75H		X	82988592	1.03735740
ITM		0	65H	65H		X	82988592	1.03735740
ITM		0	20H	20H		X	82988592	1.03735740
ITM		0	3DH	3DH		X	82988592	1.03735740
ITM		0	20H	20H		X	82988592	1.03735740
ITM		0	30H	30H		X	82988592	1.03735740
ITM		0	78H	78H		X	82988592	1.03735740
ITM		0	30H	30H			82993831	1.03742289
ITM		0	31H	31H		X	83001392	1.03751740
ITM		0	45H	45H		X	83001392	1.03751740
ITM		0	42H	42H		X	83001392	1.03751740
ITM		0	0DH	0DH		X	83001392	1.03751740
ITM		0	04H	04H		X	83001392	1.03751740
ITM		0	0DH	0DH		X	83001392	1.03751740

# KEIL $\mu$ Vision – Trace (ULINK Pro) (1)

- Trace via ETM
  - Check settings in menu:  
Flash→Configure Flash Tools... Tab:Debug

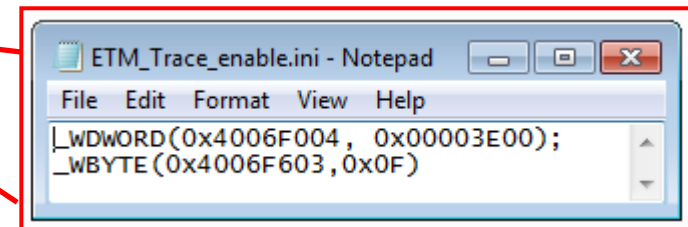
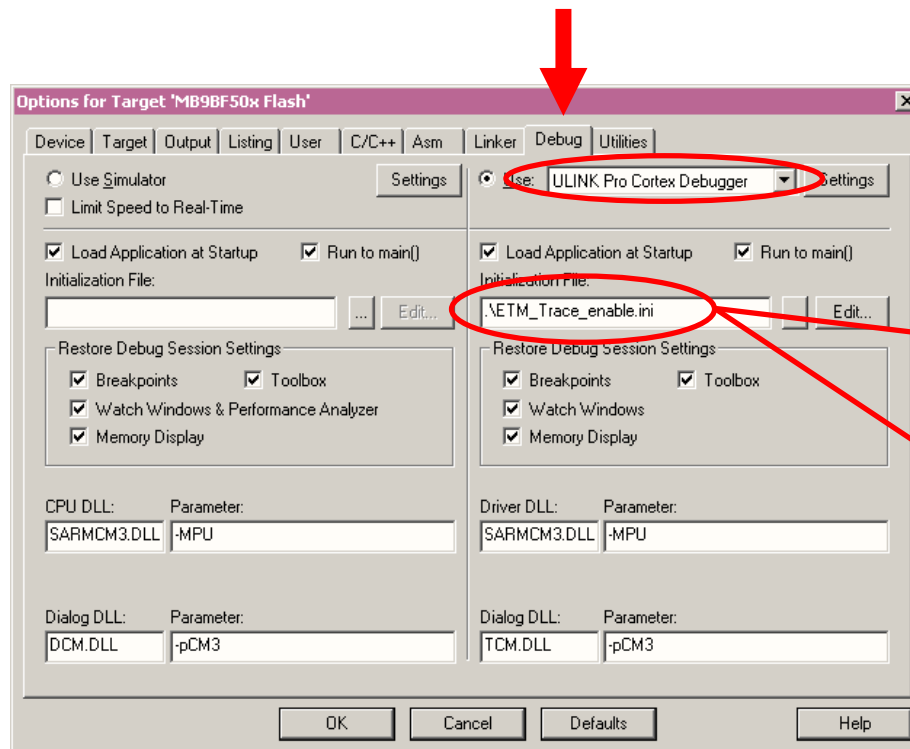

enables ETM pins

This small text file must be created first and sets the PFR and EPFR register bits for the TRACE pins.

- Instruction Trace
  - Real Time Trace recording
  - Output can be filtered by several ETM and ITM events
  - Trace buffer is held in PC memory and transferred to  $\mu$ Vision on break

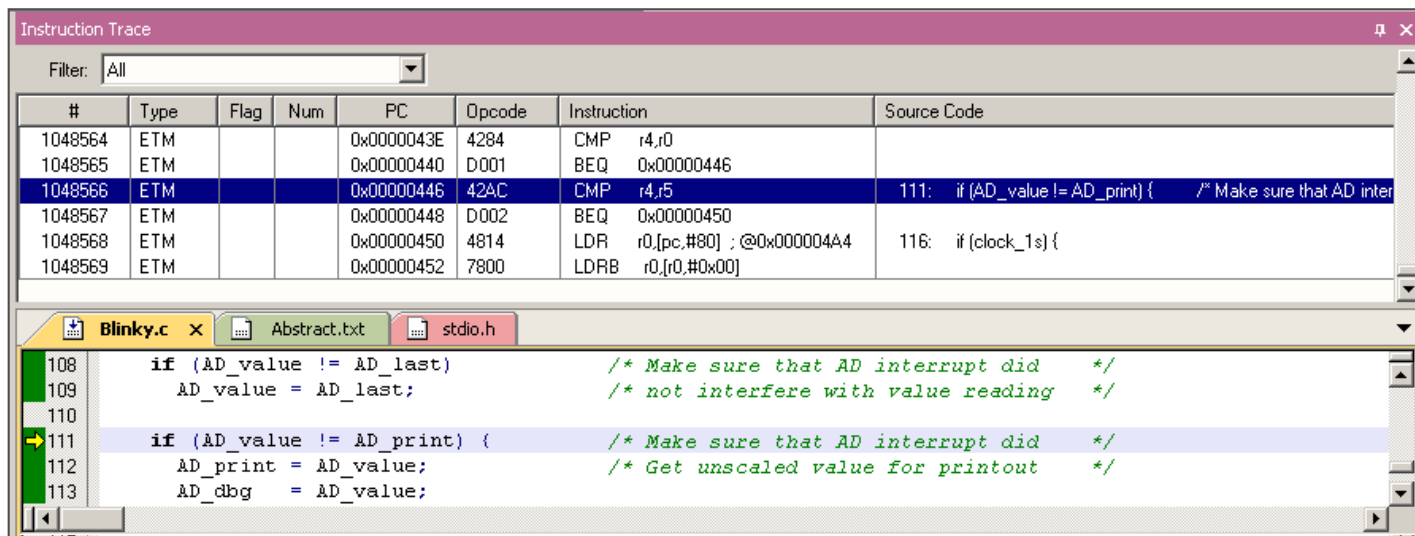

The screenshot displays the 'Instruction Trace' window in KEIL  $\mu$ Vision. The window is divided into two main sections. The top section is a table with columns: #, Type, Flag, Num, PC, Opcode, Instruction, and Source Code. The bottom section shows the source code for 'Blinky.c' with line numbers 108 through 113. The instruction at PC 0x00000446 (42AC) is highlighted in blue, corresponding to line 111 of the source code.

#	Type	Flag	Num	PC	Opcode	Instruction	Source Code
1048564	ETM			0x0000043E	4284	CMP r4,r0	
1048565	ETM			0x00000440	D001	BEQ 0x00000446	
1048566	ETM			0x00000446	42AC	CMP r4,r5	111: if (AD_value != AD_print) { /* Make sure that AD inter
1048567	ETM			0x00000448	D002	BEQ 0x00000450	
1048568	ETM			0x00000450	4814	LDR r0,[pc,#80] ;@0x000004A4	116: if (clock_1s) {
1048569	ETM			0x00000452	7800	LDRB r0,[r0,#0x00]	

```
108     if (AD_value != AD_last)           /* Make sure that AD interrupt did */
109         AD_value = AD_last;           /* not interfere with value reading */
110
111     if (AD_value != AD_print) {        /* Make sure that AD interrupt did */
112         AD_print = AD_value;           /* Get unscaled value for printout */
113         AD_dbg   = AD_value;
```



## ■ Simulator

- The Core Simulator can be selected by the menu: Flash → Configure Flash Tools... and then choosing Use Simulator
- Look & feel is like using ULINK debugger
- Controlable also with \*.ini files

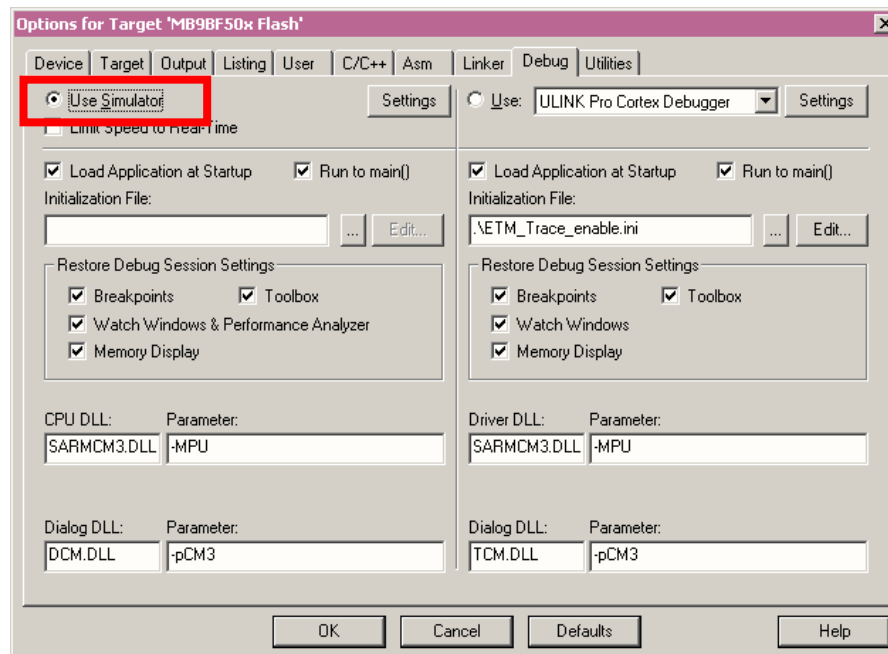



Finally

- **Gültig für EU-Länder:**
  - Gemäß der Europäischen WEEE-Richtlinie und deren Umsetzung in landesspezifische Gesetze nehmen wir dieses Gerät wieder zurück.
  - Zur Entsorgung schicken Sie das Gerät bitte an die folgende Adresse:
- **Valid for European Union Countries:**
  - According to the European WEEE-Directive and its implementation into national laws we take this device back.
  - For disposal please send the device to the following address:



**Cypress Semiconductor**  
**198 Champion Court**  
**San Jose, CA 95134 USA**

- This board is compliant with China RoHS



- Please check the following website, for any available updates

[www.cypress.com](http://www.cypress.com)

Cypress maintains a worldwide network of offices, solution centers, manufacturer's representatives, and distributors. To find the office closest to you, visit us at [Cypress Locations](#).