

GlobTek, Inc. www.globtek.com 186 Veterans Drive, Northvale, NJ 07647 Tel. (201) 784-1000 Fax (201) 784-0111	Drawing Title: GTM86101-1007.5-W2, ICT / ITE / Medical Power Supply, Efficiency Level: USA DOE Level VI / Eco-design Directive 2009/125/EC, (EU) 2019/1782, Case Color/Style: GlobTek Black, Wall Plug-in, AC Adaptor Power Supply AC Adaptor, Input Rating: 100-240V~, 50-60Hz, N. America NEMA 1-15 Fixed , Output Rating: 10W, 7.5V@1.33A, Output Configuration: 1500 mm, 22/2 Cond, UL 2468, Female Barrel 5.5 * 2.5 * 11mm with internal Spring Clip and Locking Notch or Equal, Ferrite: None, GlobTek Black, GT Cord # C7832, Pin Out: Center Positive (+V), symbol compliant with IEC 60417 symbol no. 5926, Blades/Input Cord: Fixed Blades North American 1-15P, Approvals: cETLus 60601-1; IP22; CB 60601-1-11; China RoHS; Double Insulation; EAC; Level VI; WEEE; VCCI; Ukraine; RoHS; PSE; PSE; CB 60601-1;	
	Model No. GTM86101-1007.5-W2	
	Part No./Ordering No. WR9HC1330LCPIMFR6B	Rev A

In Addition to GlobTek Inc.'s renewed ISO9001:2015 - Quality Management System Certification, GlobTek Inc. is now certified to:

ISO13485:2016 - Medical Devices Quality Management System Certification  
ISO14001:2015 - Environmental Management System Certification

ISO Certificates are available online at <https://www.globtek.com/iso-certificates/>

The acceptance of this specification and use of the product described in this document indicates the acceptance and binding of the customer to Globtek TERMS AND CONDITIONS (attached to the end of this document), which supersede all other agreements, terms, and conditions (<https://en.globtek.com/terms-and-conditions/>).

The purchaser of this product (Customer) agrees that it is their sole responsibility to determine suitability/fitness of the product described in this specification for their application and to take precautions for protection against any hazards attendant to the handling and use of the product.

Footnote:

GlobTek Inc. will not be liable for the safety and performance of these power supplies/battery packs if unauthorized access and repair occurs. End user should consult applicable UL, CSA or EN standards for proper installation instruction.

Limitation of Use:

GlobTek products are intended for use with commercial, medical, and/or industrial equipment only. GlobTek product are not authorized for use as mission critical components in life support hazardous environment, nuclear or aircraft applications without prior written approval from the CEO of GlobTek Inc.

Contents of this document are subject to change without prior notice.

### Customer Approval of Specification:

Please approve, sign and send back to GlobTek so we can complete order processing.  
A delay in receipt of this form will delay delivery schedule.

Company Name: _____	Customer P/N: _____
Quote Number: _____	Date: _____
Authorized Representative Name: _____	Authorized Representative Signature: _____

GloTek, Inc. www.globtek.com 186 Veterans Drive, Northvale, NJ 07647 Tel. (201) 784-1000 Fax (201) 784-0111	Drawing Title: GTM86101-1007.5-W2, ICT / ITE / Medical Power Supply, Efficiency Level: USA DOE Level VI / Eco-design Directive 2009/125/EC, (EU) 2019/1782, Case Color/Style: GlobTek Black, Wall Plug-in, AC Adaptor Power Supply AC Adaptor, Input Rating: 100-240V~, 50-60Hz, N. America NEMA 1-15 Fixed , Output Rating: 10W, 7.5V@1.33A, Output Configuration: 1500 mm, 22/2 Cond, UL 2468, Female Barrel 5.5 * 2.5 * 11mm with internal Spring Clip and Locking Notch or Equal, Ferrite: None, GlobTek Black, GT Cord # C7832, Pin Out: Center Positive (+V), symbol compliant with IEC 60417 symbol no. 5926, Blades/Input Cord: Fixed Blades North American 1-15P, Approvals: cETLus 60601-1; IP22; CB 60601-1-11; China RoHS; Double Insulation; EAC; Level VI; WEEE; VCCI; Ukraine; RoHS; PSE; PSE; CB 60601-1;	
	Model No. GTM86101-1007.5-W2	
	Part No./Ordering No. WR9HC1330LCPIMFR6B	Rev A

## REVISION HISTORY

REV	DESCRIPTION	SUB	DATE	APPROVED
A	Initial release	QA	10/14/2020	QA

### POWER SUPPLY INFORMATION

TYPE	Wall Plug-in
TECHNOLOGY	AC Adaptor Power Supply AC Adaptor
CASE COLOR	GlobTek Black
NAMEPLATE RATED INPUT	100-240V~, 50-60Hz, 0.3A
INPUT CONFIG	N. America NEMA 1-15 Fixed
WATTS	10.00
VOLTS OUT	7.5
CURRENT OUT (Amps)	1.33
BLADE/CORD INCLUDED	FBNA2 Fixed Blades North American 1-15P
BLADE/CORD INSTALLED	FBNA2 :Fixed Blades North American 1-15P
INGRESS PROTECTION	IP22
GROUNDING CONFIGURATION	(F1) Class II / Double Insulated
EFFICIENCY LEVEL	USA DOE Level VI / Eco-design Directive 2009/125/EC, (EU) 2019/1782
OUTPUT CONFIGURATION	1500 mm, 22/2 Cond, UL 2468, Female Barrel 5.5 * 2.5 * 11mm with internal Spring Clip and Locking Notch or Equal, Ferrite: None, GlobTek Black, GT Cord # C7832
OVERMOLDED	Yes
OUTPUT CONNECTOR GENDER	Female
CONNECTOR PIN OUT	Center Positive (+V), symbol compliant with IEC 60417 symbol no. 5926
LABEL SPECS	ISO 15223 medical device compliant label,L-1470
SPECIAL BARCODE LABEL MATERIAL	No
PACK SPEC	Standard WPI, Cellular packaging
USER MANUAL	

#### PROPRIETARY INFORMATION

<p>GlobTek, Inc. www.globtek.com 186 Veterans Drive, Northvale, NJ 07647 Tel. (201) 784-1000 Fax (201) 784-0111</p>	<p>Drawing Title: GTM86101-1007.5-W2, ICT / ITE / Medical Power Supply, Efficiency Level: USA DOE Level VI / Eco-design Directive 2009/125/EC, (EU) 2019/1782, Case Color/Style: GlobTek Black, Wall Plug-in, AC Adaptor Power Supply AC Adaptor, Input Rating: 100-240V~, 50-60Hz, N. America NEMA 1-15 Fixed , Output Rating: 10W, 7.5V@1.33A, Output Configuration: 1500 mm, 22/2 Cond, UL 2468, Female Barrel 5.5 * 2.5 * 11mm with internal Spring Clip and Locking Notch or Equal, Ferrite: None, GlobTek Black, GT Cord # C7832, Pin Out: Center Positive (+V), symbol compliant with IEC 60417 symbol no. 5926, Blades/Input Cord: Fixed Blades North American 1-15P, Approvals: cETLus 60601-1; IP22; CB 60601-1-11; China RoHS; Double Insulation; EAC; Level VI; WEEE; VCCI; Ukraine; RoHS; PSE; PSE; CB 60601-1;</p>
	<p>Model No. GTM86101-1007.5-W2</p>
	<p>Part No./Ordering No. WR9HC1330LCPIMFR6B <span style="float: right;">Rev A</span></p>

Notes/Modifications/Customizations (notes in this section supersede the values shown in the standard spec)  
DIMENSIONS ARE IN MM UNLESS SPECIFIED OTHERWISE

GlobTek, Inc. www.globtek.com 186 Veterans Drive, Northvale, NJ 07647 Tel. (201) 784-1000 Fax (201) 784-0111	Drawing Title: GTM86101-1007.5-W2, ICT / ITE / Medical Power Supply, Efficiency Level: USA DOE Level VI / Eco-design Directive 2009/125/EC, (EU) 2019/1782, Case Color/Style: GlobTek Black, Wall Plug-in, AC Adaptor Power Supply AC Adaptor, Input Rating: 100-240V~, 50-60Hz, N. America NEMA 1-15 Fixed , Output Rating: 10W, 7.5V@1.33A, Output Configuration: 1500 mm, 22/2 Cond, UL 2468, Female Barrel 5.5 * 2.5 * 11mm with internal Spring Clip and Locking Notch or Equal, Ferrite: None, GlobTek Black, GT Cord # C7832, Pin Out: Center Positive (+V), symbol compliant with IEC 60417 symbol no. 5926, Blades/Input Cord: Fixed Blades North American 1-15P, Approvals: cETLus 60601-1; IP22; CB 60601-1-11; China RoHS; Double Insulation; EAC; Level VI; WEEE; VCCI; Ukraine; RoHS; PSE; PSE; CB 60601-1;	
	Model No. GTM86101-1007.5-W2	
	Part No./Ordering No. WR9HC1330LCPIMFR6B	Rev A

## ELECTRICAL SPECIFICATIONS

01. Input Voltage: Specified 90-264 Vac, Nameplate rated: 100-240Vac
02. Input Frequency: Specified 47-63 Hz, Nameplate rated 50/60Hz
03. Output Regulation: +/- 5%
04. Line Voltage Regulation: +/- 1%
05. Output Ripple (Vp-p): 1% or 100 mV whichever is greater, measured at 20 MHz bandwidth with 0.1 uf ceramic capacitor in parallel with a low impedance 47 uf electrolytic capacitor connected at the end of the output connector
06. Hold-up Time: 5 mS minimum
07. Inrush Current: 30A maximum @ 230Vac input
08. Energy Efficiency: Complies to Efficiency Level VI and ErP European Commission's Ecodesign Directive (2005/32/EC) / CoC Tier 2 Compliant

### B) PROTECTION

01. Over-current protection: 110%-140% maximum with auto-recovery function
02. Output Over-Voltage: 110% to 130% of nominal output voltage
03. Short-circuit protection: The adapter shall not be damaged by short the DC output to Ground.

### C) SAFETY

01. Dielectric Withstand Voltage: Primary To Secondary: 4000VAC or 5656VDC for 3 seconds
02. Leakage Current: 50uA maximum, at nominal 240Vac input voltage
03. ESD Immunity per EN61000-4-2, ±8 kV contact, ±15 kV air, Perf Criteria A Standard.

### D) EMC

01. Emissions, per EN 55032, EN 61000-6-3, EN 61000-6-4
  - Conducted Emissions: Class B, FCC Part 15, Class B
  - Radiated Emissions: Class B, FCC Part 15, Class B
02. Line Frequency Harmonics EN61000-3-2, Class A
03. Voltage Fluctuations/Flicker EN61000-3-3
04. Immunity, per EN 55024, EN 61000-6-1, EN 61000-6-2
  - Static Discharge Immunity EN61000-4-2, 8kV Contact Discharge, 15kV air discharge
  - Radiated RF Immunity EN61000-4-3, 3V/m 80-2700MHz, 80% 1KHz AM.
  - EFT/Burst Immunity EN61000-4-4, 2kV/100kHz.
  - Line Surge Immunity EN61000-4-5, 1kV differential, 2kV common-mode
  - Conducted RF Immunity EN61000-4-6, 3Vrms, 80% 1KHz AM
  - Power Frequency Magnetic Field Immunity EN61000-4-8, NA
  - Voltage Dip Immunity EN61000-4-11, Criteria

### E) OTHER:

01. MTBF: 300,000 Hours @ 25°C ambient temperature
02. Operating Temperature: 0°C to 50°C ambient temperature
03. Operating Humidity: 20 ~ 85 % RH. non-condensing
05. Storage Temperature: -20°C to 60°C
06. Storage Humidity: 5 ~ 95 % RH. non-condensing
07. Cooling: Natural convection cooling
08. RoHS 2: Complies with EU 2011/65/EU China SJ/T 11364-2014

### F) ENCLOSURE

#### PROPRIETARY INFORMATION

PROPRIETARY OF GLOBTEK, INC. ANY REPRODUCTION, DISCLOSURE OR USE OF THIS DRAWING, IN WHOLE OR IN PART, IS HEREBY PROHIBITED EXCEPT AS SPECIFIED IN WRITING BY GLOBTEK, INC. © GlobTek, Inc. 2020 - 2023

quest / 05/09/2023 9:05:02 PM GMT CLONED FROM WR9HC1330CCPIMFR6B

GlobTek, Inc. www.globtek.com 186 Veterans Drive, Northvale, NJ 07647 Tel. (201) 784-1000 Fax (201) 784-0111	Drawing Title: GTM86101-1007.5-W2, ICT / ITE / Medical Power Supply, Efficiency Level: USA DOE Level VI / Eco-design Directive 2009/125/EC, (EU) 2019/1782, Case Color/Style: GlobTek Black, Wall Plug-in, AC Adaptor Power Supply AC Adaptor, Input Rating: 100-240V~, 50-60Hz, N. America NEMA 1-15 Fixed , Output Rating: 10W, 7.5V@1.33A, Output Configuration: 1500 mm, 22/2 Cond, UL 2468, Female Barrel 5.5 * 2.5 * 11mm with internal Spring Clip and Locking Notch or Equal, Ferrite: None, GlobTek Black, GT Cord # C7832, Pin Out: Center Positive (+V), symbol compliant with IEC 60417 symbol no. 5926, Blades/Input Cord: Fixed Blades North American 1-15P, Approvals: cETLus 60601-1; IP22; CB 60601-1-11; China RoHS; Double Insulation; EAC; Level VI; WEEE; VCCI; Ukraine; RoHS; PSE; PSE; CB 60601-1;	
	Model No. GTM86101-1007.5-W2	
	Part No./Ordering No. WR9HC1330LCPIMFR6B	Rev A

- 01. Housing: High impact plastic, 94V0 polycarbonate, non-vented
- 02. Markings: Label and/or Pad Printed and/or Molded in the case

**F) OPTIONS:**

- 01. Green Power On Indicator LED
- 02. NEMA 1-15P or European Schuko 7-16 AC Plug Configuration
- 03. Increased DC Output Voltage (up to 5.4V) to allow for long output cables
- 04. Special International Safety Approvals
- 05. Housing Color, special markings

TO ADDRESS SYSTEM-LEVEL EMI CONCERNS, FERRITE CHOKES/BEADS MAY BE ADDED/REVISED UPON REQUEST. A SAMPLE KIT OF GLOBTEK'S STANDARD FERRITES IS AVAILABLE UNDER GLOBTEK P/N: EMI-MITIGATION-KIT1

FOR ADDITIONAL INFORMATION, PLEASE READ OUR WHITE PAPER AT:

<https://en.globtek.com/technical-articles/ferrite-kit-radiated-emi-suppression-kit-for-globtek-power-supplies-cable-assemblies>

INGRESS PROTECTION: IP22

<p>GlobTek, Inc.  www.globtek.com  186 Veterans Drive,  Northvale, NJ 07647  Tel. (201) 784-1000  Fax (201) 784-0111</p>	<p>Drawing Title: GTM86101-1007.5-W2, ICT / ITE / Medical Power Supply, Efficiency Level: USA DOE Level VI / Eco-design Directive 2009/125/EC, (EU) 2019/1782, Case Color/Style: GlobTek Black, Wall Plug-in, AC Adaptor Power Supply AC Adaptor, Input Rating: 100-240V~, 50-60Hz, N. America NEMA 1-15 Fixed , Output Rating: 10W, 7.5V@1.33A, Output Configuration: 1500 mm, 22/2 Cond, UL 2468, Female Barrel 5.5 * 2.5 * 11mm with internal Spring Clip and Locking Notch or Equal, Ferrite: None, GlobTek Black, GT Cord # C7832, Pin Out: Center Positive (+V), symbol compliant with IEC 60417 symbol no. 5926, Blades/Input Cord: Fixed Blades North American 1-15P, Approvals: cETLus 60601-1; IP22; CB 60601-1-11; China RoHS; Double Insulation; EAC; Level VI; WEEE; VCCI; Ukraine; RoHS; PSE; PSE; CB 60601-1;</p>
	<p>Model No. GTM86101-1007.5-W2</p>
	<p>Part No./Ordering No. WR9HC1330LCPIMFR6B <span style="float: right;">Rev A</span></p>

3D File Download <https://www.globtek.com/dl/GTM86101-WVVV-W2.stp>

Mechanical drawing

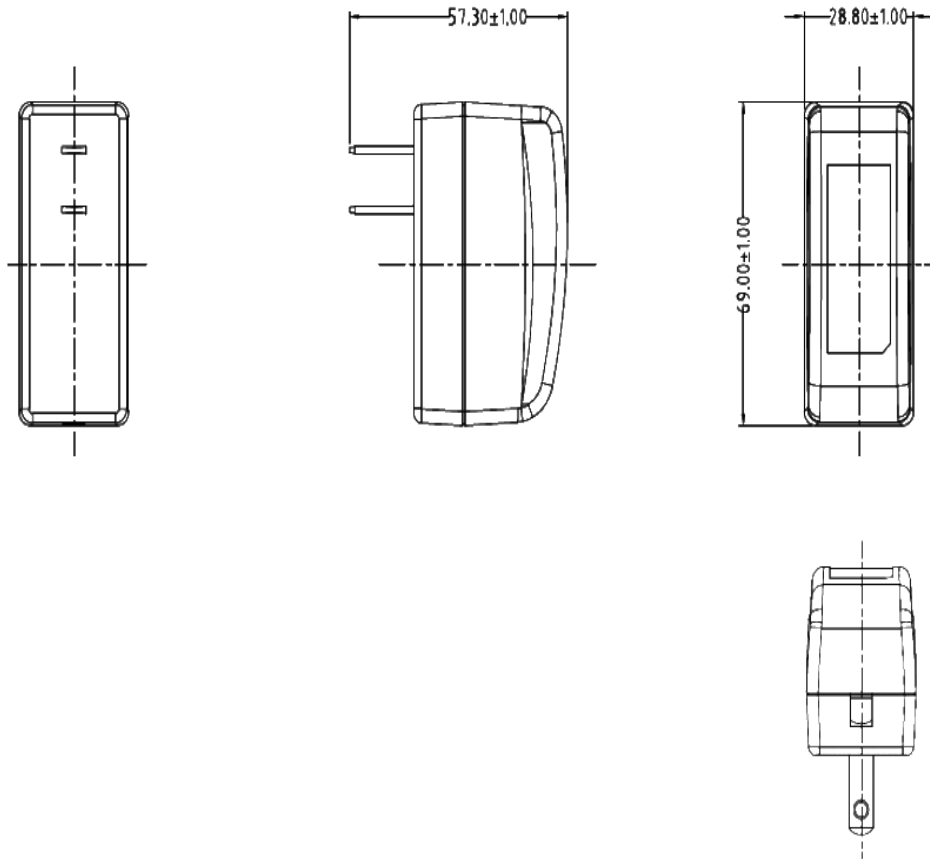

<p>GlobTek, Inc.  www.globtek.com  186 Veterans Drive,  Northvale, NJ 07647  Tel. (201) 784-1000  Fax (201) 784-0111</p>	<p>Drawing Title: GTM86101-1007.5-W2, ICT / ITE / Medical Power Supply, Efficiency Level: USA DOE Level VI / Eco-design Directive 2009/125/EC, (EU) 2019/1782, Case Color/Style: GlobTek Black, Wall Plug-in, AC Adaptor Power Supply AC Adaptor, Input Rating: 100-240V~, 50-60Hz, N. America NEMA 1-15 Fixed , Output Rating: 10W, 7.5V@1.33A, Output Configuration: 1500 mm, 22/2 Cond, UL 2468, Female Barrel 5.5 * 2.5 * 11mm with internal Spring Clip and Locking Notch or Equal, Ferrite: None, GlobTek Black, GT Cord # C7832, Pin Out: Center Positive (+V), symbol compliant with IEC 60417 symbol no. 5926, Blades/Input Cord: Fixed Blades North American 1-15P, Approvals: cETLus 60601-1; IP22; CB 60601-1-11; China RoHS; Double Insulation; EAC; Level VI; WEEE; VCCI; Ukraine; RoHS; PSE; PSE; CB 60601-1;</p>
<p>Model No. GTM86101-1007.5-W2</p>	<p>Part No./Ordering No. WR9HC1330LCPIMFR6B</p>
	<p>Rev A</p>

DERATING CURVE

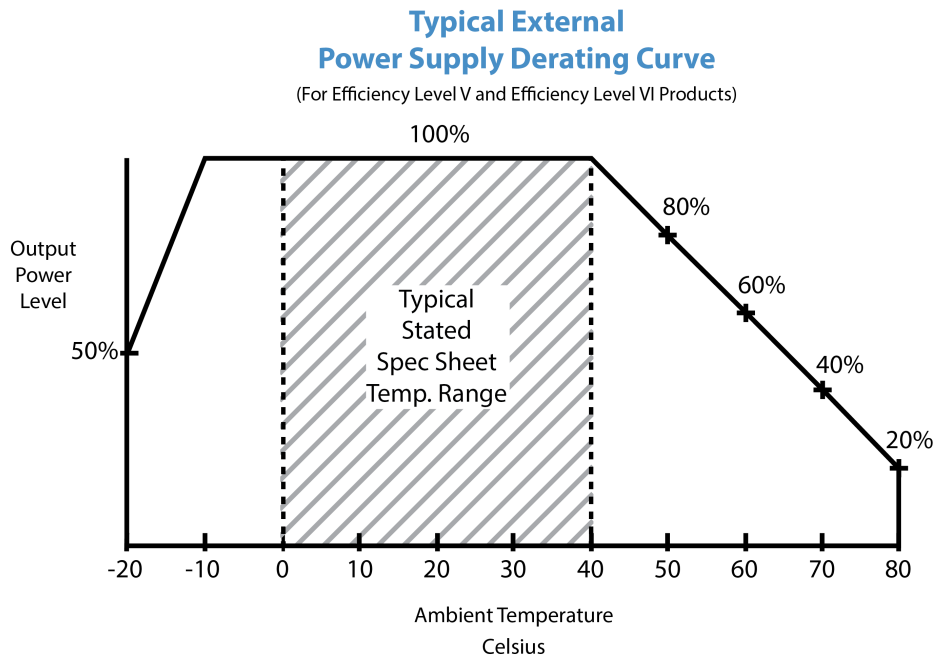

GlobTek, Inc. www.globtek.com 186 Veterans Drive, Northvale, NJ 07647 Tel. (201) 784-1000 Fax (201) 784-0111	Drawing Title: GTM86101-1007.5-W2, ICT / ITE / Medical Power Supply, Efficiency Level: USA DOE Level VI / Eco-design Directive 2009/125/EC, (EU) 2019/1782, Case Color/Style: GlobTek Black, Wall Plug-in, AC Adaptor Power Supply AC Adaptor, Input Rating: 100-240V~, 50-60Hz, N. America NEMA 1-15 Fixed , Output Rating: 10W, 7.5V@1.33A, Output Configuration: 1500 mm, 22/2 Cond, UL 2468, Female Barrel 5.5 * 2.5 * 11mm with internal Spring Clip and Locking Notch or Equal, Ferrite: None, GlobTek Black, GT Cord # C7832, Pin Out: Center Positive (+V), symbol compliant with IEC 60417 symbol no. 5926, Blades/Input Cord: Fixed Blades North American 1-15P, Approvals: cETLus 60601-1; IP22; CB 60601-1-11; China RoHS; Double Insulation; EAC; Level VI; WEEE; VCCI; Ukraine; RoHS; PSE; PSE; CB 60601-1;	
	Model No. GTM86101-1007.5-W2	
	Part No./Ordering No. WR9HC1330LCPIMFR6B	Rev A

### INPUT CONFIGURATION

(F1) Class II / Double Insulated

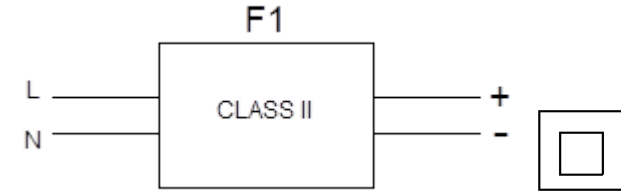

[Alternate grounding configurations](#) available upon request.

Blades/Cord Included:FBNA2:Fixed Blades North American 1-15P

Blades/Cord Installed:FBNA2:Fixed Blades North American 1-15P

NEMA 1-15P, North America Blades, Class II 2 Conductors

All NEMA 1 devices are two-wire non-grounding devices (hot-neutral) rated for 125 V maximum. NEMA 1-15P plugs have two parallel flat blades, 0.25 inches (6.35 mm) wide, 0.06 inches (1.524 mm) thick, 0.625-0.718 inches (15.875–18.256 mm) long, and spaced 0.5 inches (12.7 mm) apart.



GloTek, Inc. www.globtek.com 186 Veterans Drive, Northvale, NJ 07647 Tel. (201) 784-1000 Fax (201) 784-0111	Drawing Title: GTM86101-1007.5-W2, ICT / ITE / Medical Power Supply, Efficiency Level: USA DOE Level VI / Eco-design Directive 2009/125/EC, (EU) 2019/1782, Case Color/Style: GlobTek Black, Wall Plug-in, AC Adaptor Power Supply AC Adaptor, Input Rating: 100-240V~, 50-60Hz, N. America NEMA 1-15 Fixed , Output Rating: 10W, 7.5V@1.33A, Output Configuration: 1500 mm, 22/2 Cond, UL 2468, Female Barrel 5.5 * 2.5 * 11mm with internal Spring Clip and Locking Notch or Equal, Ferrite: None, GlobTek Black, GT Cord # C7832, Pin Out: Center Positive (+V), symbol compliant with IEC 60417 symbol no. 5926, Blades/Input Cord: Fixed Blades North American 1-15P, Approvals: cETLus 60601-1; IP22; CB 60601-1-11; China RoHS; Double Insulation; EAC; Level VI; WEEE; VCCI; Ukraine; RoHS; PSE; PSE; CB 60601-1;	
	Model No. GTM86101-1007.5-W2	
	Part No./Ordering No. WR9HC1330LCPIMFR6B	Rev A

**OUTPUT CORD AND CONNECTOR: LCL/C7832**

ACTUAL CONNECTORS, OVERMOLDS, FERRITES MAY VARY SLIGHTLY FROM THE PICTURE BELOW

CABLE TYPE	UL 2468
CABLE LENGTH (mm)	1500
CABLE TOLERANCE (mm)	+150,-0
WIRE GAUGE (AWG)	22
CONDUCTORS	2
HANK DIMENSION (mm)	70 ± 10
CABLE / CONNECTOR OVERMOLD COLOR	GlobTek Black
FERRITE TYPE AND DIMENSION	None
FERRITE NUMBER OF TURNS <a href="#">(Definition)</a>	N/A
FERRITE DIMENSION FROM STRAIN RELIEF	N/A
FERRITE DIMENSION FROM PLUG	N/A
PLUG TYPE	Female Barrel 5.5 * 2.5 * 11mm with internal Spring Clip and Locking Notch or Equal
OUTPUT CONNECTOR GENDER	Female
OVERMOLDED	Yes
OVER MOLD ORIENTATION	Straight
CONNECTOR PIN OUT	Center Positive (+V), symbol compliant with IEC 60417 symbol no. 5926

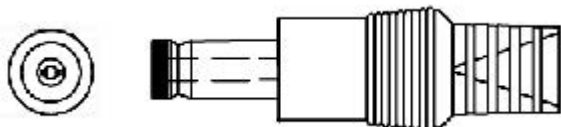

ADDITIONAL OUTPUT PLUG OPTIONS ARE AVAILABLE AT <https://www.globtek.com/connectors/>  
STANDARD PLUGS AND CONNECTORS CAN BE SEEN ONLINE AT <https://www.globtek.com/connectors/>  
CALCULATE VOLTAGE REGULATION/DROP WITH OUR ONLINE CALCULATOR: <https://en.globtek.com/output-cable-regulation-calculator/>

<p>GlobTek, Inc.  www.globtek.com  186 Veterans Drive,  Northvale, NJ 07647  Tel. (201) 784-1000  Fax (201) 784-0111</p>	<p>Drawing Title: GTM86101-1007.5-W2, ICT / ITE / Medical Power Supply, Efficiency Level: USA DOE Level VI / Eco-design Directive 2009/125/EC, (EU) 2019/1782, Case Color/Style: GlobTek Black, Wall Plug-in, AC Adaptor Power Supply AC Adaptor, Input Rating: 100-240V~, 50-60Hz, N. America NEMA 1-15 Fixed , Output Rating: 10W, 7.5V@1.33A, Output Configuration: 1500 mm, 22/2 Cond, UL 2468, Female Barrel 5.5 * 2.5 * 11mm with internal Spring Clip and Locking Notch or Equal, Ferrite: None, GlobTek Black, GT Cord # C7832, Pin Out: Center Positive (+V), symbol compliant with IEC 60417 symbol no. 5926, Blades/Input Cord: Fixed Blades North American 1-15P, Approvals: cETLus 60601-1; IP22; CB 60601-1-11; China RoHS; Double Insulation; EAC; Level VI; WEEE; VCCI; Ukraine; RoHS; PSE; PSE; CB 60601-1;</p>
	<p>Model No. GTM86101-1007.5-W2</p>
	<p>Part No./Ordering No. WR9HC1330LCPIMFR6B <span style="float: right;">Rev A</span></p>

**OUTPUT CONNECTOR HOOK UP**

TO ADDRESS SYSTEM-LEVEL EMI CONCERNS, FERRITE CHOKES/BEADS MAY BE ADDED/REVISED UPON REQUEST. A SAMPLE KIT OF GLOBTEK'S STANDARD FERRITES IS AVAILABLE UNDER GLOBTEK P/N: EMI-MITIGATION-KIT1

FOR ADDITIONAL INFORMATION, PLEASE READ OUR WHITE PAPER AT:

<https://en.globtek.com/technical-articles/ferrite-kit-radiated-emi-suppression-kit-for-globtek-power-supplies-cable-assemblies>

GloTek, Inc. www.globtek.com 186 Veterans Drive, Northvale, NJ 07647 Tel. (201) 784-1000 Fax (201) 784-0111	Drawing Title: GTM86101-1007.5-W2, ICT / ITE / Medical Power Supply, Efficiency Level: USA DOE Level VI / Eco-design Directive 2009/125/EC, (EU) 2019/1782, Case Color/Style: GlobTek Black, Wall Plug-in, AC Adaptor Power Supply AC Adaptor, Input Rating: 100-240V~, 50-60Hz, N. America NEMA 1-15 Fixed , Output Rating: 10W, 7.5V@1.33A, Output Configuration: 1500 mm, 22/2 Cond, UL 2468, Female Barrel 5.5 * 2.5 * 11mm with internal Spring Clip and Locking Notch or Equal, Ferrite: None, GlobTek Black, GT Cord # C7832, Pin Out: Center Positive (+V), symbol compliant with IEC 60417 symbol no. 5926, Blades/Input Cord: Fixed Blades North American 1-15P, Approvals: cETLus 60601-1; IP22; CB 60601-1-11; China RoHS; Double Insulation; EAC; Level VI; WEEE; VCCI; Ukraine; RoHS; PSE; PSE; CB 60601-1;	
	Model No. GTM86101-1007.5-W2	
	Part No./Ordering No. WR9HC1330LCPIMFR6B	Rev A

**LABEL:L-1470**

LABEL P/N	ISO 15223 medical device compliant label
MATERIAL	Flat Thermal Transfer, Imprintable, Polyester Label and/or Pad Printed and/or Molded, and/or Laser Engraved in the case
BACKGROUND COLOR	Black if housing is Black, White or Silver if housing is White or Gray.
TEXT COLOR	White or Silver if label is Black Background for Black housing. Black if label is White or Silver background and Housing is White or Gray.
LABEL WIDTH (mm)	39.7
LABEL HEIGHT (mm)	16.2
SPECIAL BARCODE LABEL MATERIAL	No

Below is the minimum information which will appear on the label. NOTE: in the logo area additional/actual positioning of symbols and text is subjected to change as per agency updates/requirements or additional model approvals become available. Agency logos may be in Regulatory Certifications/Label Markings area on the label or molded into the case housing outside the label area. Information will be shown via Label and/or Pad Printed and/or Molded in the case.

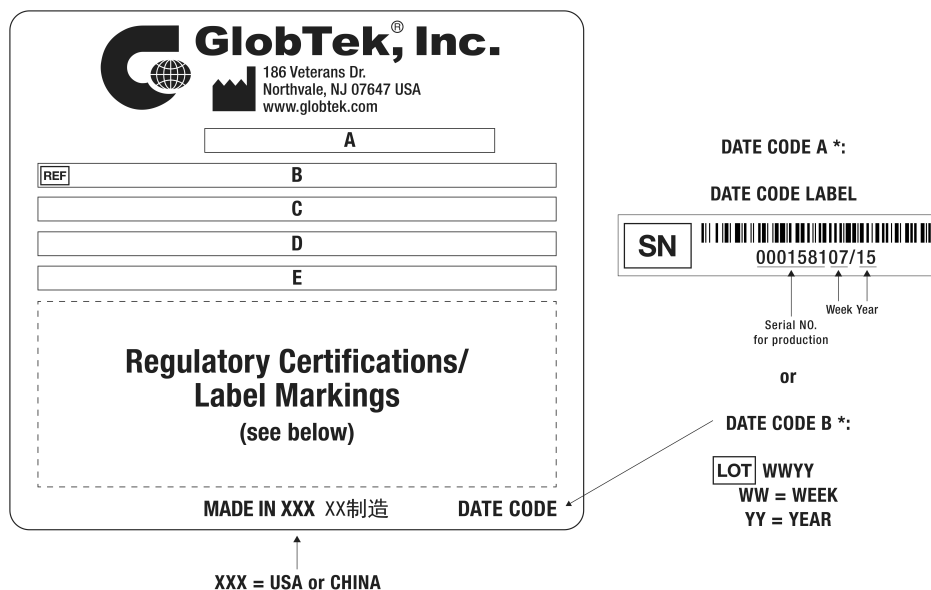

A=ICT / ITE / Medical Power Supply  
B=P/N: (料号) WR9HC1330LCPIMFR6B  
C=Model (型号) GTM86101-1007.5-W2  
D=Input (输入)100-240V~, 50-60Hz, 0.3A  
E=Output (输出)7.5 V 1.33 A, 10.00W

GlobTek, Inc. www.globtek.com 186 Veterans Drive, Northvale, NJ 07647 Tel. (201) 784-1000 Fax (201) 784-0111	Drawing Title: GTM86101-1007.5-W2, ICT / ITE / Medical Power Supply, Efficiency Level: USA DOE Level VI / Eco-design Directive 2009/125/EC, (EU) 2019/1782, Case Color/Style: GlobTek Black, Wall Plug-in, AC Adaptor Power Supply AC Adaptor, Input Rating: 100-240V~, 50-60Hz, N. America NEMA 1-15 Fixed , Output Rating: 10W, 7.5V@1.33A, Output Configuration: 1500 mm, 22/2 Cond, UL 2468, Female Barrel 5.5 * 2.5 * 11mm with internal Spring Clip and Locking Notch or Equal, Ferrite: None, GlobTek Black, GT Cord # C7832, Pin Out: Center Positive (+V), symbol compliant with IEC 60417 symbol no. 5926, Blades/Input Cord: Fixed Blades North American 1-15P, Approvals: cETLus 60601-1; IP22; CB 60601-1-11; China RoHS; Double Insulation; EAC; Level VI; WEEE; VCCI; Ukraine; RoHS; PSE; PSE; CB 60601-1;	
	Model No. GTM86101-1007.5-W2	
	Part No./Ordering No. WR9HC1330LCPIMFR6B	Rev A

AGENCY ONLINE DOCUMENTS	<a href="http://www.globtek.info/certs/GTM86101/">http://www.globtek.info/certs/GTM86101/</a>
CE EC-Declaration for Medical	<a href="http://globtek.force.com/models/ec_declaration_product?id=01t3a000005CMhM&amp;m=1">http://globtek.force.com/models/ec_declaration_product?id=01t3a000005CMhM&amp;m=1</a>
CE EC-Declaration for Industrial/Commercial/ITE	<a href="http://globtek.force.com/models/ec_declaration_product?id=01t3a000005CMhM&amp;i=5">http://globtek.force.com/models/ec_declaration_product?id=01t3a000005CMhM&amp;i=5</a>
CE EC-Declaration for Household	<a href="#">Contact GlobTek for more information</a>
UKCA-Declaration for Medical	<a href="http://globtek.force.com/models/ukca_declaration_product?id=01t3a000005CMhM&amp;m=1">http://globtek.force.com/models/ukca_declaration_product?id=01t3a000005CMhM&amp;m=1</a>
UKCA-Declaration for Industrial/Commercial/ITE	<a href="http://globtek.force.com/models/ukca_declaration_product?id=01t3a000005CMhM&amp;i=5">http://globtek.force.com/models/ukca_declaration_product?id=01t3a000005CMhM&amp;i=5</a>
UKCA-Declaration for Household	<a href="#">Contact GlobTek for more information</a>
Morocco SDoC Declaration	<a href="https://globtek.secure.force.com/models/Morocco_SDoC_Declaration?id=a0O3a00000LvGZDEA3">https://globtek.secure.force.com/models/Morocco_SDoC_Declaration?id=a0O3a00000LvGZDEA3</a>
RoHS/RoHS3 Declaration	<a href="https://www.globtek.com/pdf/rohs_cert/01t3a000005CMhMAAW">https://www.globtek.com/pdf/rohs_cert/01t3a000005CMhMAAW</a>
REACH Declaration	<a href="https://www.globtek.com/pdf/iso_certificates/REACH.pdf">https://www.globtek.com/pdf/iso_certificates/REACH.pdf</a>
Conflict Minerals Declaration	<a href="https://www.globtek.com/pdf/conflict-minerals.pdf">https://www.globtek.com/pdf/conflict-minerals.pdf</a>
Prop 65 Statement	<a href="https://en.globtek.com/prop-65-statement.pdf">https://en.globtek.com/prop-65-statement.pdf</a>

IPXY rating is based on 3rd party testing and customers should check suitability and test system level IPXY rating before ordering.

## Regulatory Certifications/Label Markings

Below follows a link to the latest regulatory certifications and marks for this specific product. National standards as well as certification schemes are constantly changing and so is the set of certification marks and symbols applicable to this product. Various standards, marks and symbols, and certificates are subject to change at any time without notice.

Additional standards or unique country certifications are available upon request. Please contact Globtek to request a quotation.

LATEST PRODUCT/MODEL CERTIFICATIONS: <https://www.globtek.com/datasheet/w70577>

AGENCY ONLINE DOCUMENTS <http://www.globtek.info/certs/GTM86101/>



(F1) Class II / Double Insulated

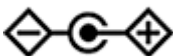

Center Positive (+V), symbol compliant with IEC 60417 symbol no. 5926

<p>GlobTek, Inc. www.globtek.com 186 Veterans Drive, Northvale, NJ 07647 Tel. (201) 784-1000 Fax (201) 784-0111</p>	<p>Drawing Title: GTM86101-1007.5-W2, ICT / ITE / Medical Power Supply, Efficiency Level: USA DOE Level VI / Eco-design Directive 2009/125/EC, (EU) 2019/1782, Case Color/Style: GlobTek Black, Wall Plug-in, AC Adaptor Power Supply AC Adaptor, Input Rating: 100-240V~, 50-60Hz, N. America NEMA 1-15 Fixed , Output Rating: 10W, 7.5V@1.33A, Output Configuration: 1500 mm, 22/2 Cond, UL 2468, Female Barrel 5.5 * 2.5 * 11mm with internal Spring Clip and Locking Notch or Equal, Ferrite: None, GlobTek Black, GT Cord # C7832, Pin Out: Center Positive (+V), symbol compliant with IEC 60417 symbol no. 5926, Blades/Input Cord: Fixed Blades North American 1-15P, Approvals: cETLus 60601-1; IP22; CB 60601-1-11; China RoHS; Double Insulation; EAC; Level VI; WEEE; VCCI; Ukraine; RoHS; PSE; PSE; CB 60601-1;</p>
	<p>Model No. GTM86101-1007.5-W2</p>
	<p>Part No./Ordering No. WR9HC1330LCPIMFR6B <span style="float: right;">Rev A</span></p>

**PACKAGING**

Packing Spec P/N:	Standard WPI, Cellular packaging
Box Qty	120
Gift Box Size (mm):	Cellular Packaging
Gift Box Color:	None
Master Carton Size (mm):	470 x 310 x 284
Master Carton Cubic Volume (m³):	0.04
Master GW (Kg):	15.6 kg
BLADES INCLUDED:	FBNA2: Fixed Blades North American 1-15P
BLADE/CORD INSTALLED:	FBNA2: Fixed Blades North American 1-15P
USER MANUAL*:	
USER MANUAL WEB LINK:	

\* This specification sheet is considered the user manual for all applications. It is expected that the buyer of this product will use it to formulate their own user manual for their end product and a user manual specifically for the power adapter is not usually required. If a user manual is not specifically listed above then none will be provided with this unit.

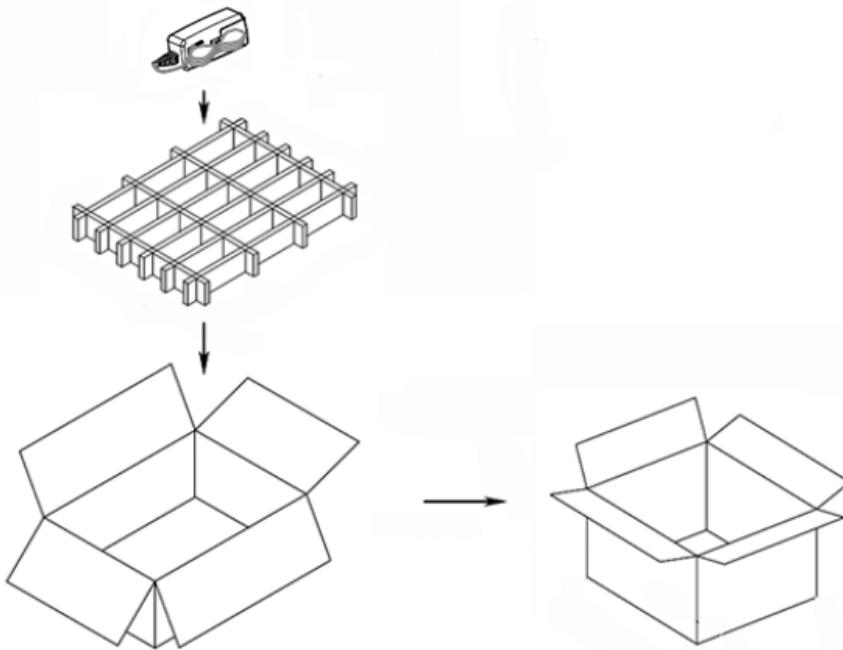

<p>GlobTek, Inc. www.globtek.com 186 Veterans Drive, Northvale, NJ 07647 Tel. (201) 784-1000 Fax (201) 784-0111</p>	<p>Drawing Title: GTM86101-1007.5-W2, ICT / ITE / Medical Power Supply, Efficiency Level: USA DOE Level VI / Eco-design Directive 2009/125/EC, (EU) 2019/1782, Case Color/Style: GlobTek Black, Wall Plug-in, AC Adaptor Power Supply AC Adaptor, Input Rating: 100-240V~, 50-60Hz, N. America NEMA 1-15 Fixed , Output Rating: 10W, 7.5V@1.33A, Output Configuration: 1500 mm, 22/2 Cond, UL 2468, Female Barrel 5.5 * 2.5 * 11mm with internal Spring Clip and Locking Notch or Equal, Ferrite: None, GlobTek Black, GT Cord # C7832, Pin Out: Center Positive (+V), symbol compliant with IEC 60417 symbol no. 5926, Blades/Input Cord: Fixed Blades North American 1-15P, Approvals: cETLus 60601-1; IP22; CB 60601-1-11; China RoHS; Double Insulation; EAC; Level VI; WEEE; VCCI; Ukraine; RoHS; PSE; PSE; CB 60601-1;</p>
	<p>Model No. GTM86101-1007.5-W2</p>
	<p>Part No./Ordering No. WR9HC1330LCPIMFR6B <span style="float: right;">Rev A</span></p>

## INSTRUCTIONS TO THE OEM SYSTEMS ENGINEER

It is the responsibility of the OEM systems engineer to provide the end system user instructions and warnings for the use of this product in the end system.

If an input cord is required for this product, AC Mains voltage should be provided to the power supply by a power supply cord approved to the national standards of the country in which it will be used.

This product is not designed to be repaired. No serviceable parts inside. A blown internal fuse is an indication of catastrophic failure of circuit component(s). If a Failure Analysis is required for a failed power supply/battery charger, please return the damaged unit to GlobTek for an accurate determination of the root cause of the failure.

EMC Compliance of the complete OEM product, including the GlobTek power supply/battery charger needs to be verified by the OEM systems engineer.

## INSTRUCTION SHEET

N/A

<p>GlobTek, Inc. www.globtek.com 186 Veterans Drive, Northvale, NJ 07647 Tel. (201) 784-1000 Fax (201) 784-0111</p>	<p>Drawing Title: GTM86101-1007.5-W2, ICT / ITE / Medical Power Supply, Efficiency Level: USA DOE Level VI / Eco-design Directive 2009/125/EC, (EU) 2019/1782, Case Color/Style: GlobTek Black, Wall Plug-in, AC Adaptor Power Supply AC Adaptor, Input Rating: 100-240V~, 50-60Hz, N. America NEMA 1-15 Fixed , Output Rating: 10W, 7.5V@1.33A, Output Configuration: 1500 mm, 22/2 Cond, UL 2468, Female Barrel 5.5 * 2.5 * 11mm with internal Spring Clip and Locking Notch or Equal, Ferrite: None, GlobTek Black, GT Cord # C7832, Pin Out: Center Positive (+V), symbol compliant with IEC 60417 symbol no. 5926, Blades/Input Cord: Fixed Blades North American 1-15P, Approvals: cETLus 60601-1; IP22; CB 60601-1-11; China RoHS; Double Insulation; EAC; Level VI; WEEE; VCCI; Ukraine; RoHS; PSE; PSE; CB 60601-1;</p>	
	<p>Model No. GTM86101-1007.5-W2</p>	
	<p>Part No./Ordering No. WR9HC1330LCPIMFR6B</p>	<p>Rev A</p>

